

Data sheet | Item number: 216-152

Ferrule; Sleeve for 0.34 mm² / AWG 24; uninsulated; electro-tin plated

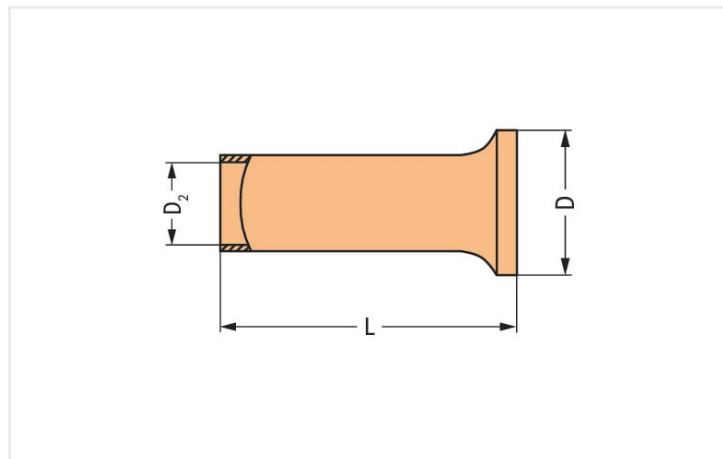

<https://www.wago.com/216-152>



Dimensions in mm

Technical data

Main product function	Ferrule
Sleeve cross-section (AWG)	22 AWG
Sleeve for	0.34 mm ²

Connection data

Strip length	5 mm / 0.2 inches
--------------	-------------------

Physical data

Length	5 mm
Diameter	1.8 mm
Diameter 2	0.85 mm

Material Data

Fire load	0 MJ
Weight	0 g

Commercial data

Product Group	2 (Terminal Block Accessories)
eCl@ss 10.0	27-40-02-01
eCl@ss 9.0	27-40-02-01
ETIM 8.0	EC000005
ETIM 7.0	EC000005
PU (SPU)	5000 (1000) pcs
Packaging type	Box
Country of origin	DE
GTIN	4017332277587
Customs tariff number	85369010000

Downloads

Environmental Product Compliance

Compliance Search

Environmental Product
Compliance 216-152



Documentation

Bid Text

216-152	19.02.2019	xml 2.77 KB	
216-152	11.09.2017	doc 24.00 KB	

Installation notes

A perfect gas-tight crimp – both electrical-ly and mechanically reliable

X-ON Electronics

Largest Supplier of Electrical and Electronic Components

Click to view similar products for [Wago manufacturer](#):

Other Similar products are found below :

[0207-1331](#) [0207-1332](#) [0207-1333](#) [0233-0505](#) [0233-0506](#) [0233-0510](#) [0236-0402](#) [0236-0404](#) [0256-0402](#) [0256-0403](#) [0256-0404](#) [0256-0405](#)
[0256-0406](#) [0256-0408](#) [0280-0681](#) [0280-0687](#) [0280-0833](#) [0280-0907](#) [0281-0611](#) [0281-0611/0281-0418/RN01-0000](#) [0281-0623](#) [0281-](#)
[0623/0281-0418/RN01-0000](#) [0281-0681](#) [0281-0907](#) [0282-0681](#) [0282-0687](#) [0282-0696](#) [0282-0901](#) [0283-0402](#) [0283-0671](#) [0283-0901](#) [0285-](#)
[0635](#) [0733-0102](#) [0733-0108](#) [0733-0110](#) [0733-0112](#) [145-261](#) [2000-1201](#) [2000-1203](#) [2000-1205](#) [2000-1207](#) [2000-1291](#) [2000-1292](#) [2000-](#)
[1307](#) [2000-1401](#) [2000-1403](#) [2000-1404](#) [2000-1407](#) [2000-2231](#) [2000-402](#)