

Data sheet | Item number: 221-500

Mounting carrier; 221 Series - 4 mm²; for DIN-35 rail mounting/screw mounting; orange

www.wago.com/221-500

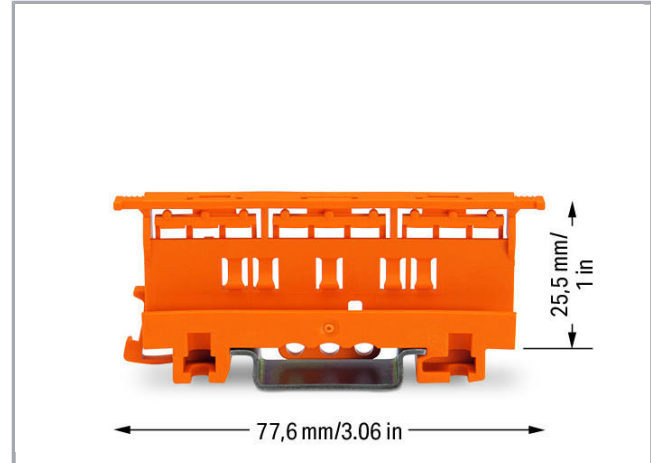
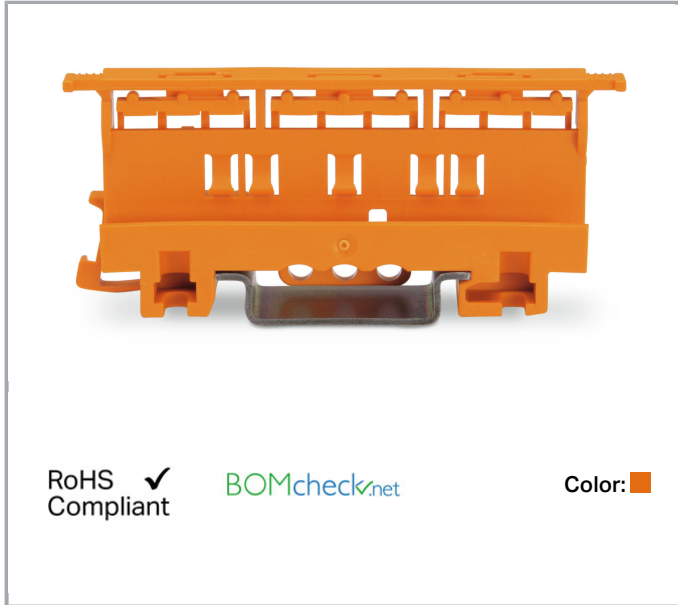

Data

Geometrical Data

Width	17.5 mm / 0.689 inch
Height from upper-edge of DIN-35 rail	25.5 mm / 1.004 inch
Depth	77.6 mm / 3.055 inch

Material Data

Color	orange
Insulating material	Polyamide 66 (PA 66)
Flammability class per UL94	V0
Weight	9.6 g

Commercial data

Packaging type	BOX
Country of origin	CN
GTIN	4055143421942
Customs Tariff No.	39269097900

Subject to changes.

WAGO Kontakttechnik GmbH & Co. KG
Hansastr. 27
32423 Minden
Phone: +49571 887-0 | Fax: +49571 887-169
Email: info.de@wago.com | Web: www.wago.com

Do you have any questions about our products?
We are always happy to take your call at +49 (571) 887-44222.

Compatible products

Marking accessories



Item no.: 210-833
Marking strips; on reel; 6 mm wide; plain; Self-adhesive; white

www.wago.com/210-833

Mounting adapter



Item no.: 222-505
Strain relief plate; for mounting carrier; 221 or 222 Series, can be snapped

www.wago.com/222-505



Item no.: 222-510
Angled DIN-rail adapter; in combination with mounting carrier; 221-500 or 222-500; for DIN-35 rail mounting; gray

www.wago.com/222-510

Downloads

Documentation

Additional Information

Technical explanations	Apr 3, 2019	pdf 2.1 MB	Download
------------------------	-------------	---------------	----------

CAD/CAE-Data

CAD data

2D/3D Models 221-500	URL	Download
----------------------	-----	----------

CAE data

EPLAN Data Portal 221-500	Download
---------------------------	----------

Installation Notes

Subject to changes.

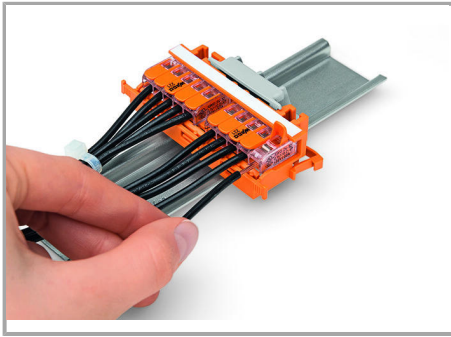

CAGE CLAMP® connection:

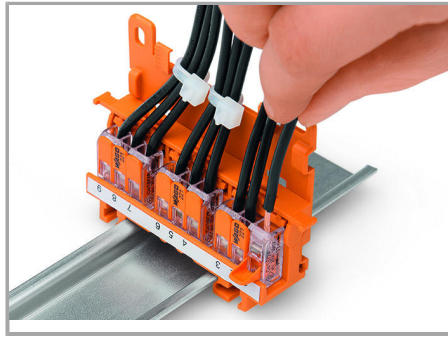

Removing a conductor.

Conductor termination with connectors fitted in a mounting carrier

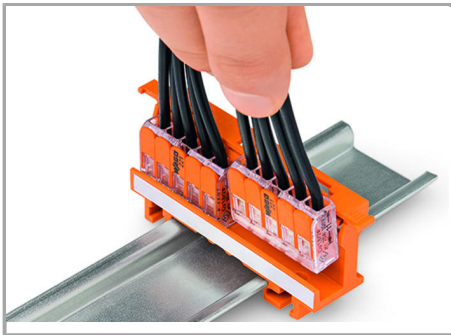

Inserting a connector into the mounting carrier.

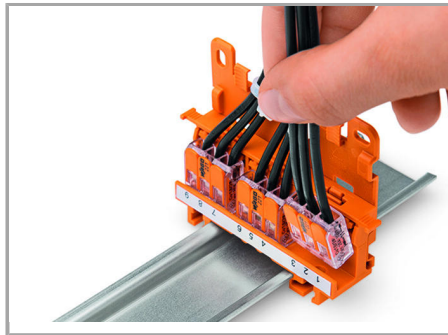

Inserting a connector into the mounting carrier.

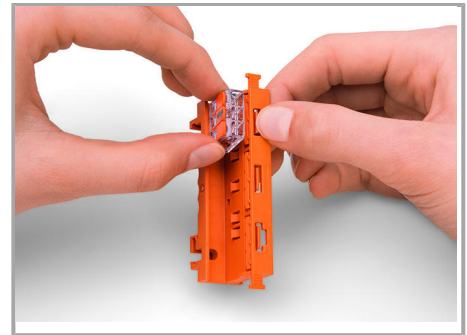

Removing a connector from the mounting carrier.

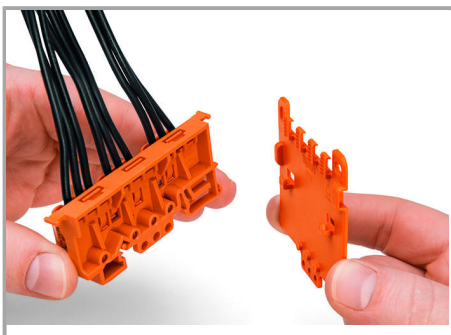

Securing a strain relief plate (222-505) to the mounting carrier.

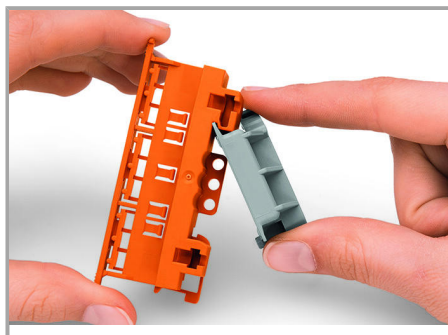

Snapping the angled DIN-rail adapter (222-510) onto the mounting carrier.

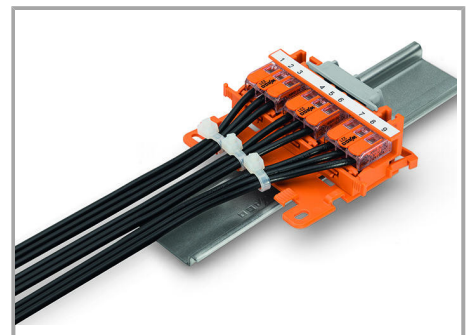

Horizontal mounting on DIN-35 rail using an angled DIN-rail adapter.

Subject to changes.

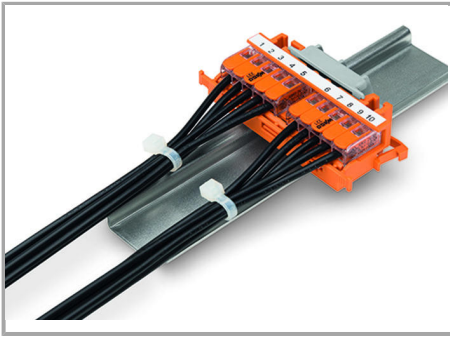

Horizontal mounting on DIN-35 rail using an angled DIN-rail adapter.

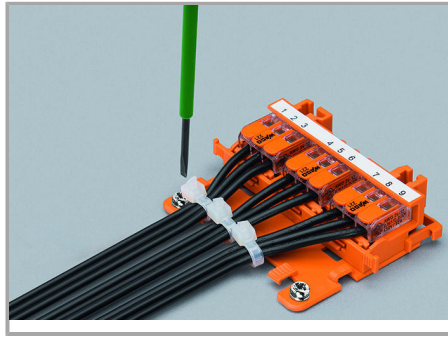

Horizontal screw mounting with strain relief plate on a flat surface

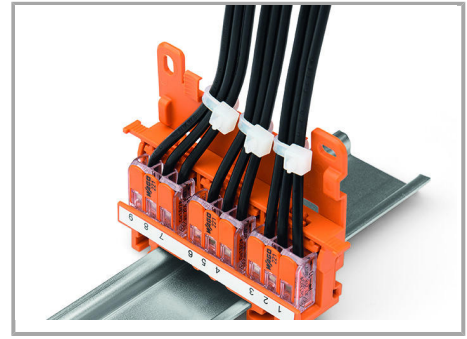

Vertical mounting with strain relief plate on DIN-35 rail.

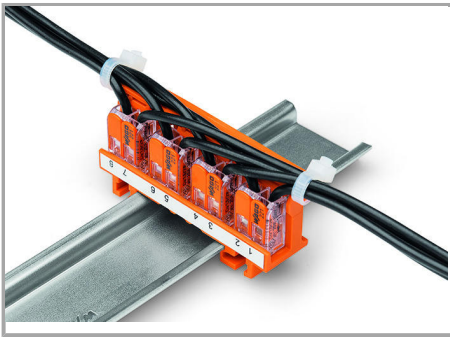

Strain relief via cable ties on the mounting carrier (transverse to the connectors' wiring direction) – clamping units labeled via marking strips (210-334).

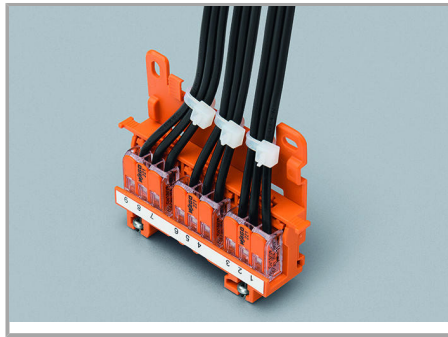

Vertical screw mounting with strain relief plate on a flat surface.

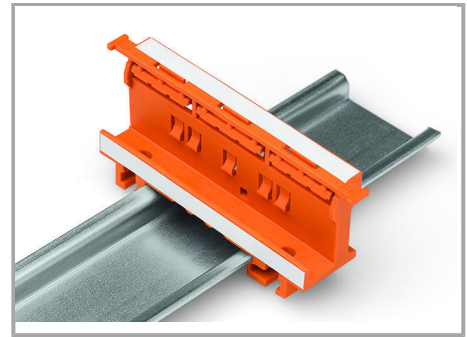

Mounting carrier on a DIN-35 rail

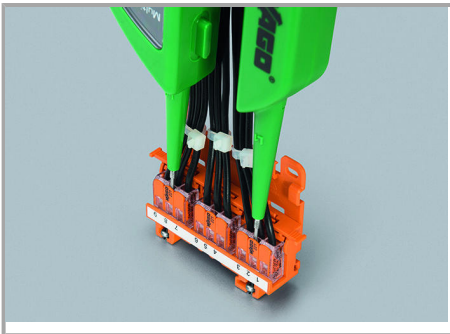

Testing connectors via test slots on top of the carrier.

Subject to changes.

X-ON Electronics

Largest Supplier of Electrical and Electronic Components

Click to view similar products for [Accessories for Robotics and RC](#) category:

Click to view products by [Wago](#) manufacturer:

Other Similar products are found below :

[56T705](#) [015-9516-002](#) [01.001.6453.0](#) [641763-8](#) [CW106-01X](#) [CW30101A](#) [CW31701A](#) [D2041839](#) [70.352.0628.0](#) [73.353.4028.1](#) [FB22001A](#)
[FB30601A](#) [9009030000](#) [9501](#) [121587-0026](#) [1218510-1](#) [1218629-4](#) [1218630-4](#) [1261000A00M001](#) [128-26-5](#) [RFI77-14](#) [1367251-2](#) [14](#) [1-](#)
[449604-1](#) [1460g4](#) [1470g4](#) [DV0PM20034](#) [MS27488-16-1](#) [MS3057-12A W/B](#) [MS3057-8A-624](#) [MS600-2-XP-1A](#) [MS-602-GEE-14-07C](#)
[MS603-12-01A](#) [MS90376-14R](#) [MS90376-16RB](#) [MTB1-11PH3](#) [1676610000](#) [1A9224 REV A](#) [210-115](#) [CA20L22](#) [2227383-1](#) [225-0090-000](#)
[225-0098-000](#) [KA-89-82](#) [CB20201X](#) [KC-89-104](#) [CB30601A](#) [CB31201A](#) [236-600](#) [CBC120210-752](#)