

Data sheet | Item number: 2604-1104

PCB terminal block; lever; 4 mm²; Pin spacing 5 mm; 4-pole; Push-in CAGE CLAMP®; 4,00 mm²; gray

www.wago.com/2604-1104



Color: —



Subject to changes. Please also observe the further product documentation!

WAGO GmbH & Co. KG
Hansastr. 27
32423 Minden
Phone: +49571 887-0 | Fax: +49571 887-169
Email: info.de@wago.com | Web: www.wago.com

Do you have any questions about our products?
We are always happy to take your call at +49 (571) 887-44222.

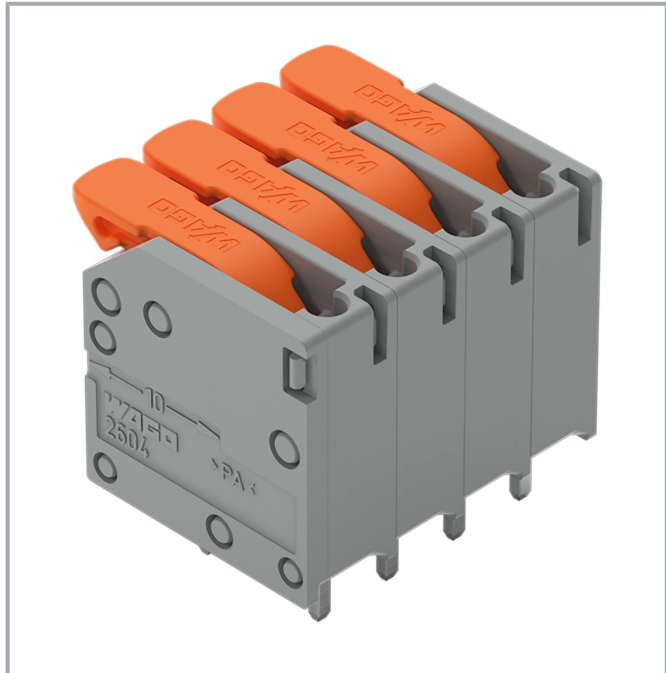
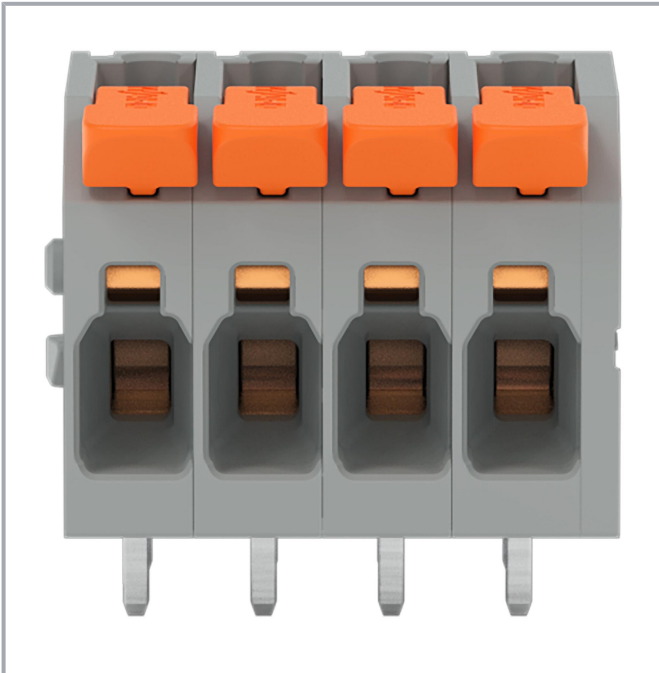

Current-Carrying Capacity Curve
 Pin spacing: 5 mm / Conductor cross-section: 4 mm² "f-st"
 Based on: EN 60512-5-2 / Reduction factor: 1

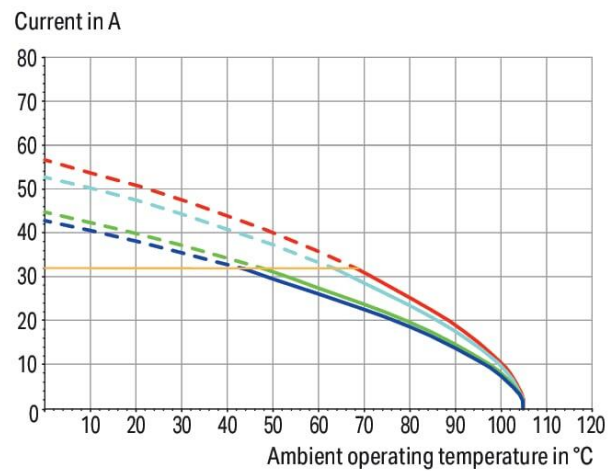

Subject to changes. Please also observe the further product documentation!

WAGO GmbH & Co. KG
 Hansastr. 27
 32423 Minden
 Phone: +49571 887-0 | Fax: +49571 887-169
 Email: info.de@wago.com | Web: www.wago.com

Do you have any questions about our products?
 We are always happy to take your call at +49 (571) 887-44222.

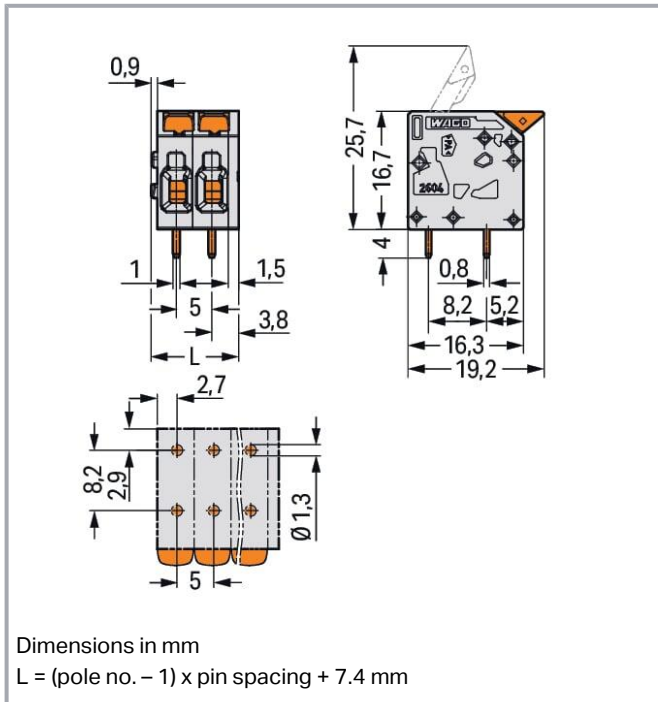

Item description

- PCB terminal blocks with Push-in CAGE CLAMP® connection and levers
- Push-in termination of solid and ferruled conductors
- Intuitive and tool-free operation
- Several clamping units can be held open simultaneously, simplifying the connection of multi-core cables
- Testing can be performed both parallel and perpendicular to conductor entry

Data

Notes

Variants:

Other pole numbers

Direct marking

Other colors

Other versions (or variants) can be requested from WAGO Sales or configured at <https://configurator.wago.com/>.

Electrical data

Ratings per IEC/EN

Ratings per

IEC/EN 60664-1

Subject to changes. Please also observe the further product documentation!

WAGO GmbH & Co. KG

Hansastr. 27

32423 Minden

Phone: +49571 887-0 | Fax: +49571 887-169

Email: info.de@wago.com | Web: www.wago.com

Do you have any questions about our products?

We are always happy to take your call at +49 (571) 887-44222.



Nominal voltage (III/3)	320 V
Rated impulse voltage (III/3)	4 kV
Rated voltage (III/2)	400 V
Rated impulse voltage (III/2)	4 kV
Nominal voltage (II/2)	630 V
Rated surge voltage (II/2)	4 kV
Rated current	32 A
Legend (ratings)	(III / 2) $\hat{=}$ Overvoltage category III / Pollution degree 2

Ratings per UL

Approvals per	UL 1059
Rated voltage UL (Use Group B)	300 V
Rated current UL (Use Group B)	20 A
Rated voltage UL (Use Group D)	300 V
Rated current UL (Use Group D)	10 A

Ratings per CSA

Approvals per	CSA
Rated voltage CSA (Use Group B)	300 V
Rated current CSA (Use Group B)	20 A
Rated voltage CSA (Use Group D)	300 V
Rated current CSA (Use Group D)	5 A

Connection data

Connection points	4
Total number of potentials	4
Number of connection types	1
Number of levels	1

Connection 1

Connection technology	Push-in CAGE CLAMP®
Actuation type	Lever
Solid conductor	0.2 ... 4 mm ² / 24 ... 12 AWG
Fine-stranded conductor	0.2 ... 4 mm ² / 24 ... 12 AWG
Fine-stranded conductor; with insulated ferrule	0.25 ... 2.5 mm ²
Fine-stranded conductor; with uninsulated ferrule	0.25 ... 2.5 mm ²

Subject to changes. Please also observe the further product documentation!



Fine-stranded conductor; with twin ferrule	0.25 ... 1.5 mm ²
Strip length	9 ... 11 mm / 0.35 ... 0.43 inches
Conductor connection direction to PCB	0 °
Pole number	4

Physical data

Pin spacing	5 mm / 0.197 inches
Width	22.4 mm / 0.882 inches
Height	20.7 mm / 0.815 inches
Height from the surface	16.7 mm / 0.657 inches
Depth	19.2 mm / 0.756 inches
Solder pin length	4 mm
Solder pin dimensions	0.8 x 1 mm
Drilled hole diameter with tolerance	1.3 ^(+0.1) mm

PCB contact

PCB contact	THT
Solder pin arrangement	over the entire terminal strip (in-line)
Number of solder pins per potential	2

Material data

Note (material data)	Information on material specifications can be found here
Color	gray
Material group	I
Insulation material	Polyamide (PA66)
Flammability class per UL94	V0
Clamping spring material	Chrome-nickel spring steel (CrNi)
Contact material	Electrolytic copper (E _{Cu})
Contact plating	Tin
Fire load	0.156 MJ
Actuator color	orange
Weight	6.2 g

Subject to changes. Please also observe the further product documentation!

Environmental requirements

Limit temperature range	-60 ... +105 °C
Processing temperature	-35 ... +60 °C
Continuous operating temperature	-60 ... +105 °C

Commercial data



eCl@ss 10.0	27-44-04-01
eCl@ss 9.0	27-44-04-01
ETIM 8.0	EC002643
ETIM 7.0	EC002643
ECCN	NO DATA
PU (SPU)	90 pcs
Packaging type	box
Country of origin	PL
GTIN	4066966389753
Customs tariff number	8536901000

Environmental Product Compliance

RoHS Compliance Status	Compliant, No Exemption
------------------------	-------------------------

Approvals / Certificates







General approvals

Logo	Approval	Additional Approval Text	Certificate name
	CB DEKRA Certification B.V.	IEC 60947-7-4	NL-61583
	CSA DEKRA Certification B.V.	C22.2 No. 158	70117145
	cURus Underwriters Laboratories Inc.	UL 1059	E45172
	KEMA/KEUR DEKRA Certification B.V.	EN 60947-7-4	71-100535

Subject to changes. Please also observe the further product documentation!

Optional accessories

Ferrule

Ferrule		
	Item no.: 216-106 Ferrule; Sleeve for 2.5 mm ² / AWG 14; uninsulated; electro-tin plated; silver-colored	www.wago.com/216-106
	Item no.: 216-241 Ferrule; Sleeve for 0.5 mm ² / 20 AWG; insulated; electro-tin plated; electrolytic copper; gastight crimped; acc. to DIN 46228, Part 4/09.90; white	www.wago.com/216-241
	Item no.: 216-242 Ferrule; Sleeve for 0.75 mm ² / 18 AWG; insulated; electro-tin plated; electrolytic copper; gastight crimped; acc. to DIN 46228, Part 4/09.90; gray	www.wago.com/216-242
	Item no.: 216-243 Ferrule; Sleeve for 1 mm ² / AWG 18; insulated; electro-tin plated; electrolytic copper; gastight crimped; acc. to DIN 46228, Part 4/09.90; red	www.wago.com/216-243
	Item no.: 216-244 Ferrule; Sleeve for 1.5 mm ² / AWG 16; insulated; electro-tin plated; electrolytic copper; gastight crimped; acc. to DIN 46228, Part 4/09.90; black	www.wago.com/216-244
	Item no.: 216-246 Ferrule; Sleeve for 2.5 mm ² / AWG 14; insulated; electro-tin plated; electrolytic copper; gastight crimped; acc. to DIN 46228, Part 4/09.90; blue	www.wago.com/216-246

Downloads

Documentation

Additional Information

Technical Section	2019 Apr 3	pdf	Download
Technical explanations		2.1 MB	

CAD/CAE-Data

CAD data

2D/3D Models 2604-1104	URL	Download
------------------------	-----	----------

PCB Design

Symbol and Footprint via Ultra Librarian 2604-1104	URL	Download
--	-----	----------

CAX data for your PCB design, consisting of "schematic symbols and PCB footprints", allow easy integration of the WAGO component into your development environment.

Supported formats:

Subject to changes. Please also observe the further product documentation!



- Accel EDA 14 & 15
- Altair
- Altium 6 to current version
- Autodesk Fusion 360
- Cadence Allegro
- DesignSpark
- Eagle Libraries
- KiCad
- Mentor Graphics
- BoardStation
- Mentor Graphics Design Architect
- Mentor Graphics Design
- Expedition 99 and 2000
- OrCAD 9.X PCB and Capture
- PADS PowerPCB 3, 3.5, 4.X, and 5.X
- PADS PowerPCB and PowerLogic 3.0
- PCAD 2000, 2001, 2002, 2004, and 2006
- Pulsonix 8.5 or newer
- STL
- 3D STEP
- TARGET 3001!
- View Logic ViewDraw
- Quadcept
- Zuken CadStar 3 and 4
- Zuken CR-5000 and CR-8000
- Zuken eCADSTAR 2020 and 2021Zuken CR-5000 and CR-8000

PCB Component Libraries (EDA), PCB CAD Library Ultra Librarian

Symbol and Footprint via SamacSys 2604-1104

[URL](#)

[Download](#)

CAX data for your PCB design, consisting of "schematic symbols and PCB footprints", allow easy integration of the WAGO component into your development environment.

Supported formats:

- 3D (stp)
- Altium
- CADSTAR

—
Subject to changes. Please also observe the further product documentation!



- Capture
- CircuitStudio
- CR-5000
- CR-8000
- DEHDL
- DesignSpark PCB
- DesignSpark PCB PRO
- DipTrace
- EAGLE
- Easy-PC
- EasyEDA
- eCADSTAR
- KiCad
- OrCAD_Allegro16
- PADS
- Proteus
- Pulsonix
- Quadcept
- SOLIDWORKS PCB
- TARGET 3001!
- xDX Designer
- Xpedition

PCB Component Libraries (EDA), PCB CAD Library SamacSys Electronic Component Search Engine

CAE data

ZUKEN Portal 2604-1104	URL	Download
------------------------	---------------------	--------------------------

Asset Administration Shell

Asset Administration Shell 2604-1104	URL	Download
--------------------------------------	---------------------	--------------------------

Environmental Product Compliance

Compliance Search

Environmental Product Compliance 2604-1104	URL	Download
--	---------------------	--------------------------

Subject to changes. Please also observe the further product documentation!

WAGO GmbH & Co. KG
Hansastr. 27
32423 Minden
Phone: +49571 887-0 | Fax: +49571 887-169
Email: info.de@wago.com | Web: www.wago.com

Do you have any questions about our products?
We are always happy to take your call at +49 (571) 887-44222.

PCB terminal block; lever; 4 mm²; Pin spacing 5 mm; 4-pole; Push-in CAGE CLAMP®;
4,00 mm²; gray

Installation Notes

Conductor termination

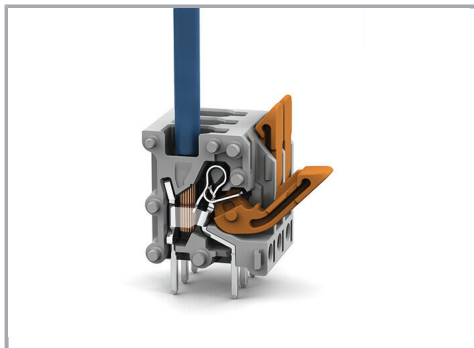

Insert fine-stranded conductors – and remove all conductors – via operating tool.

Conductor termination

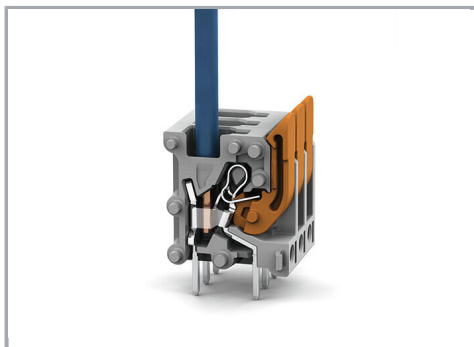

Insert solid conductors via push-in termination.

Subject to changes. Please also observe the further product documentation!

X-ON Electronics

Largest Supplier of Electrical and Electronic Components

Click to view similar products for [Wago manufacturer](#):

Other Similar products are found below :

[733-106](#) [734-190](#) [750-430/025-000](#) [750-460](#) [231-118/026-000](#) [231-620/019-000](#) [250-209](#) [2734-108/037-000](#) [280-438](#) [285-135](#) [231-446/001-000_NR](#) [231-610](#) [232-216/026-000](#) [260-306](#) [264-726](#) [0280-0833](#) [2001-1207](#) [870-901](#) [855-2701/064-001](#) [830-800/000-305](#) [811-421](#) [811-420](#) [2006-1661](#) [750-960](#) [750-504](#) [731-138/048-000](#) [788-515](#) [793-5666](#) [811-317](#) [857-409](#) [857-415](#) [870-917](#) [258-5000](#) [255-406](#) [285-407](#) [713-1108](#) [821-104](#) [2060-473/998-404](#) [787-712](#) [830-1000/000-000](#) [2000-5372](#) [852-1417](#) [231-332/108-000](#) [750-421](#) [750-842](#) [769-615](#) [753-437](#) [2009-145](#) [852-1305/000-001](#) [852-1322](#)