



PCB terminal block; operating lever; 4 mm²; Pin spacing 5 mm; 8-pole; Push-in CAGE CLAMP®

Item No.: 2604-3108



PCB terminal block; operating lever; 4 mm²; Pin spacing 5 mm; 8-pole; Push-in CAGE CLAMP®

Marking

RoHS ✓
Compliant

Business data

Supplier	WAGO
Item no.	2604-3108
GTIN / EAN	4055143564779
Content	1
Order amount	40
Customer item number	

Notes

Item description: PCB terminal blocks with lever-actuated Push-in CAGE CLAMP® connection Push-in termination of solid and ferruled conductors Intuitive and tool-free operation Several clamping units can be held open simultaneously – convenient for terminating multi-core cables Testing can be performed both parallel and perpendicular to conductor entry

Technical data

Miscellaneous

Available upon request (depending on quantity required):	Other pole numbers
Packaging type	BOX

Technical data	
<i>Ratings per</i>	<i>IEC/EN 60664-1</i>
<i>Rated voltage (III / 3) [V]</i>	<i>320 [V]</i>
<i>Rated impulse voltage (III / 3) [kV]</i>	<i>4 [kV]</i>
<i>Rated voltage (III/2) [V]</i>	<i>400 [V]</i>
<i>Rated impulse voltage (III / 2) [kV]</i>	<i>4 [kV]</i>
<i>Rated voltage (II / 2) [V]</i>	<i>630 [V]</i>
<i>Rated impulse voltage (II / 2) [kV]</i>	<i>4 [kV]</i>
<i>Rated current [A]</i>	<i>32 [A]</i>
<i>Legend (ratings)</i>	<i>(III / 2) Overvoltage category III / Pollution degree 2</i>
<i>No. of poles</i>	<i>8</i>
<i>Total number of connection points</i>	<i>8</i>
<i>Total number of potentials</i>	<i>8</i>
<i>Number of connection types</i>	<i>1</i>
<i>Number of levels</i>	<i>1</i>
<i>Connection technology</i>	<i>Push-in CAGE CLAMP®</i>
<i>Actuation type</i>	<i>Operating lever</i>
<i>Solid conductor</i>	<i>0.2 ... 4 mm² / 24 ... 12 AWG</i>
<i>Fine-stranded conductor</i>	<i>0.2 ... 4 mm² / 24 ... 12 AWG</i>
<i>Fine-stranded conductor with ferrule with plastic collar</i>	<i>0.25 ... 2.5 mm²</i>
<i>Fine-stranded conductor with ferrule without plastic collar</i>	<i>0.25 ... 2.5 mm² / ...</i>
<i>Strip length</i>	<i>9 ... 11 mm / 0.35 ... 0.43 Inch</i>
<i>Conductor entry angle to the PCB [°]</i>	<i>90 [°]</i>
<i>Pin spacing</i>	<i>5 mm (0.197 in)</i>
<i>Width</i>	<i>42.4 mm / 1.669 Inch</i>
<i>Height</i>	<i>25.3 mm / 0.996 Inch</i>
<i>Height from the surface</i>	<i>21.3 mm / 0.839 Inch</i>
<i>Depth</i>	<i>16.7 mm / 0.657 Inch</i>
<i>Solder pin length [mm]</i>	<i>4 [mm]</i>
<i>Solder pin dimensions</i>	<i>0.8 x 1 mm</i>
<i>Drilled hole diameter (tolerance) [mm]</i>	<i>1.3(+ 0.1) [mm]</i>
<i>PCB contact</i>	<i>THT</i>
<i>Solder pin arrangement</i>	<i>over the entire terminal strip, in line</i>
<i>Number of solder pins per potential</i>	<i>2</i>
<i>Color</i>	<i>gray</i>

Technical data	
<i>Material group</i>	<i>I</i>
<i>Insulating material</i>	<i>Polyamide 66 (PA 66)</i>
<i>Flammability class per UL94</i>	<i>V0</i>
<i>Clamping spring material</i>	<i>Chrome nickel spring steel (CrNi)</i>
<i>Contact material</i>	<i>Electrolytic copper (Ecu)</i>
<i>Contact plating</i>	<i>tin-plated</i>
<i>Fire load [MJ]</i>	<i>0.187 [MJ]</i>
<i>Actuating element color</i>	<i>orange</i>
<i>Weight [g]</i>	<i>13.4 [g]</i>
<i>Limit temperature range</i>	<i>-60 ... 105 °C</i>
<i>Pin spacing from [mm]</i>	<i>5 [mm]</i>
<i>Main product function</i>	<i>PCB terminal block</i>
<i>Product type</i>	<i>PCB terminal blocks</i>

Images & drawings



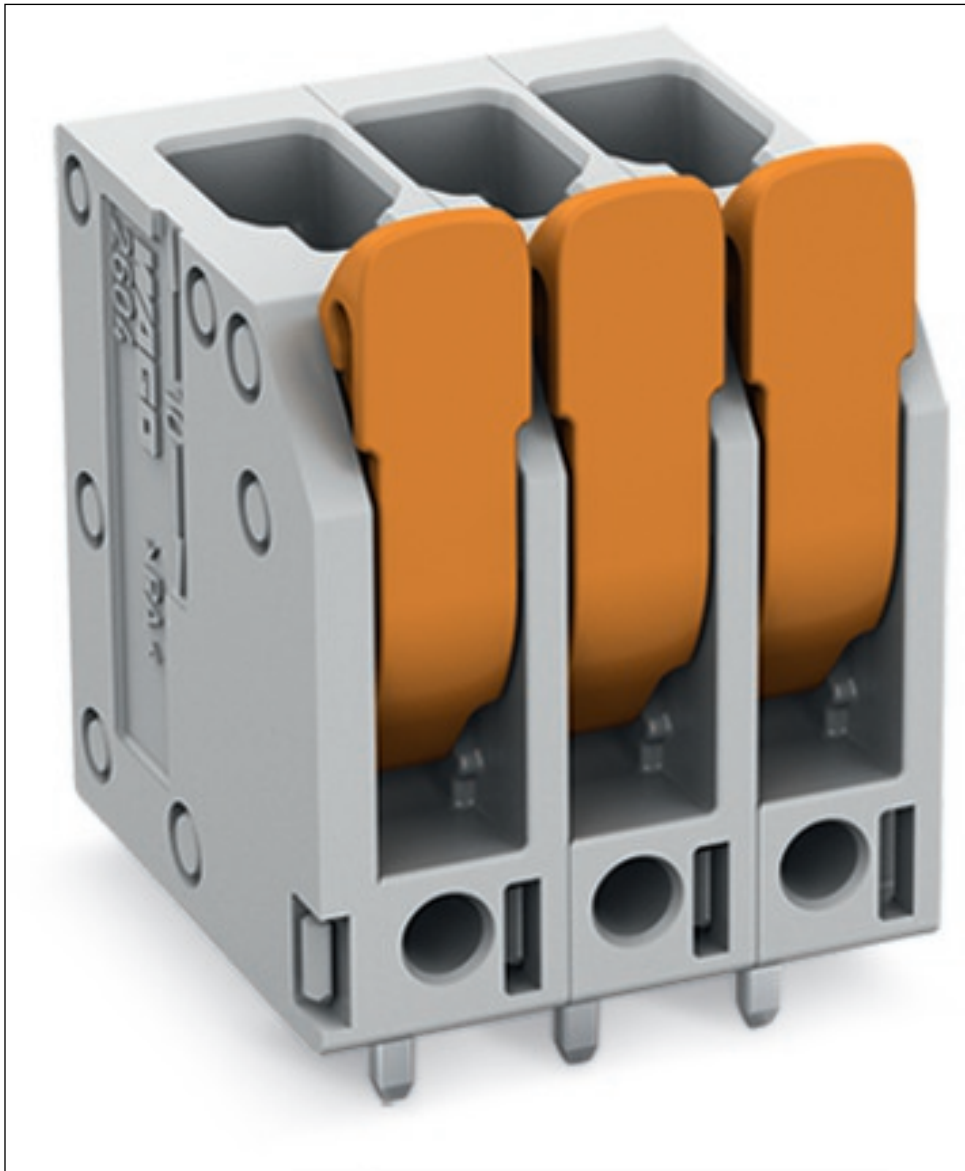

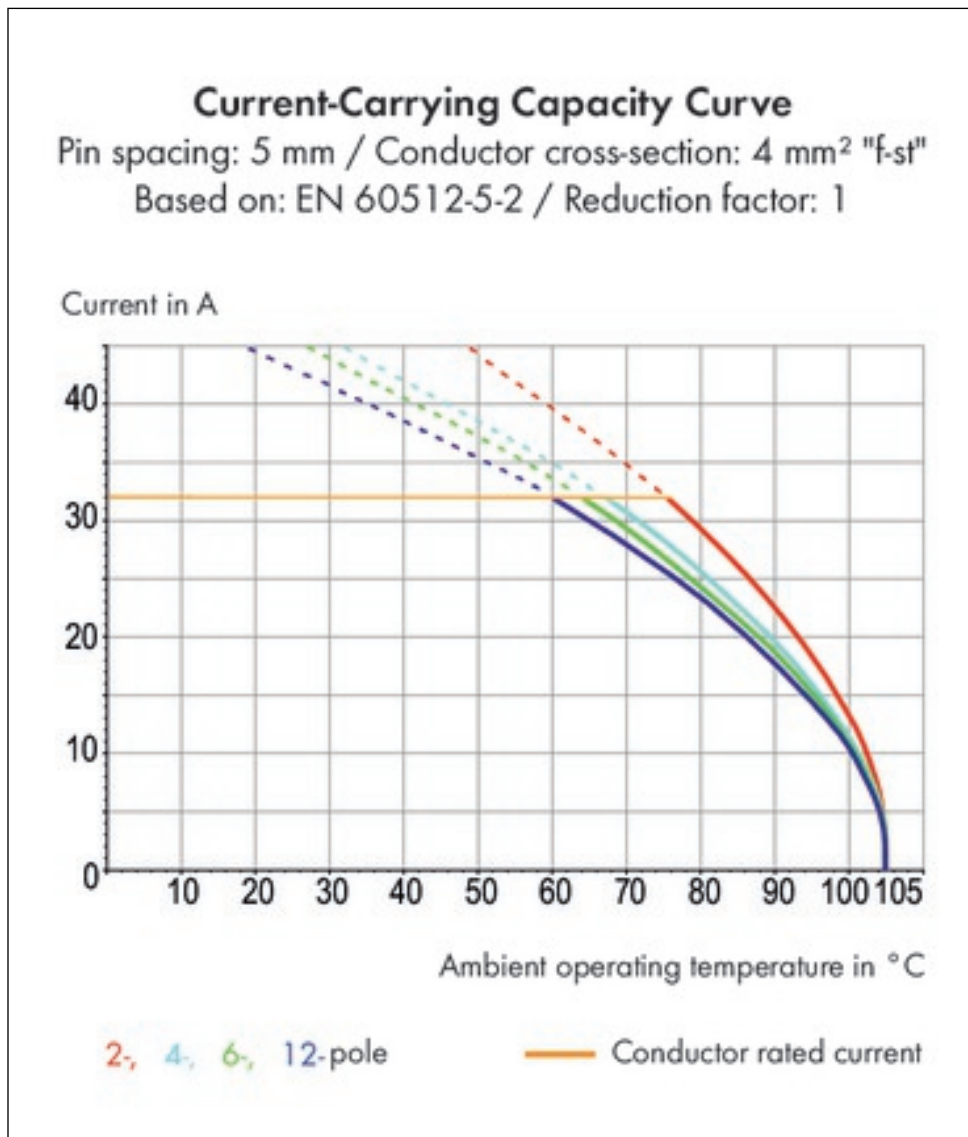

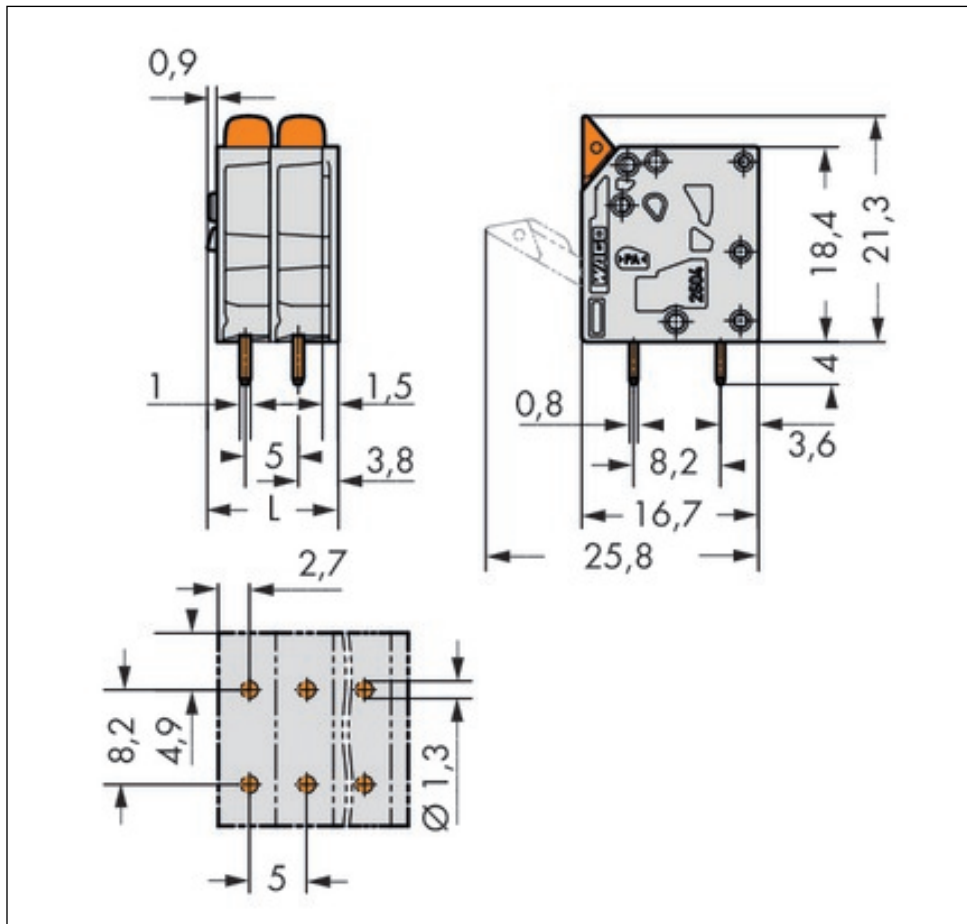

Address

WAGO Kontakttechnik GmbH & Co. KG

Hansastr. 27

32423 Minden

Telefon: 0571/887-0

Fax: 0571/887-169

<http://www.wago.com>

© WAGO Kontakttechnik GmbH & Co. KG

Technische Änderungen und Irrtümer vorbehalten.

X-ON Electronics

Largest Supplier of Electrical and Electronic Components

Click to view similar products for [Wago manufacturer](#):

Other Similar products are found below :

[734-190](#) [750-460](#) [209-574](#) [231-118/026-000](#) [231-620/019-000](#) [250-209](#) [2734-108/037-000](#) [280-438](#) [285-135](#) [231-446/001-000_NR](#) [232-216/026-000](#) [264-726](#) [2010-1207](#) [2001-1207](#) [830-800/000-305](#) [811-421](#) [2006-1661](#) [750-960](#) [210-197](#) [248-504](#) [731-138/048-000](#) [750-604](#) [773-108](#) [793-5666](#) [811-317](#) [811-411](#) [857-415](#) [255-406](#) [280-675](#) [285-407](#) [0745-0302](#) [2060-473/998-404](#) [830-1000/000-000](#) [2000-5372](#) [769-412](#) [221-525](#) [852-1417](#) [2636-3105/020-000](#) [2009-110](#) [231-332/108-000](#) [281-512/281-501](#) [750-421](#) [750-842](#) [769-615](#) [753-437](#) [2009-145](#) [750-463](#) [852-1305/000-001](#) [852-1322](#) [852-1328](#)