

Data sheet | Item number: 733-109/037-000

1-conductor female plug; 100% protected against mismatching; Locking lever;
0.5 mm²; Pin spacing 2.5 mm; 9-pole; 0,50 mm²; light gray

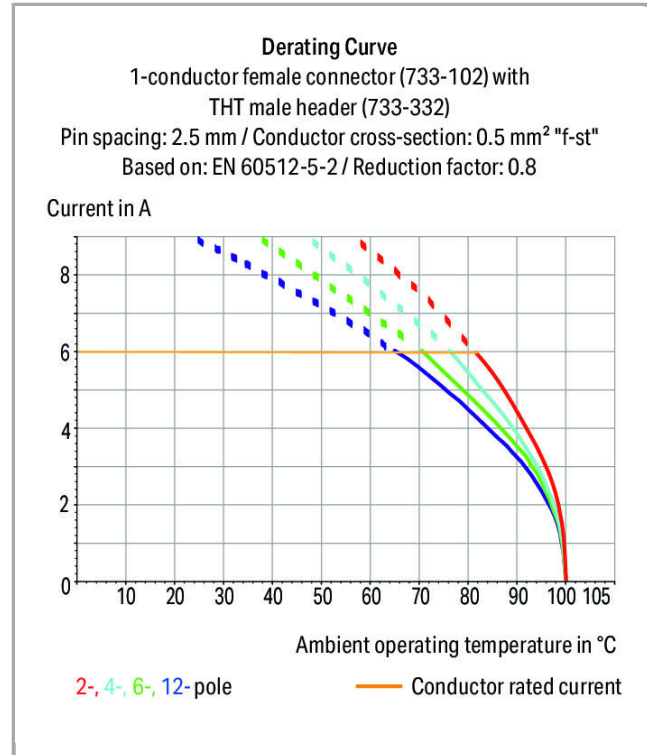

www.wago.com/733-109/037-000



Subject to changes.

WAGO Kontakttechnik GmbH & Co. KG
Hansastr. 27
32423 Minden
Phone: +49571 887-0 | Fax: +49571 887-169
Email: info.de@wago.com | Web: www.wago.com

Do you have any questions about our products?
We are always happy to take your call at +49 (571) 887-44222.

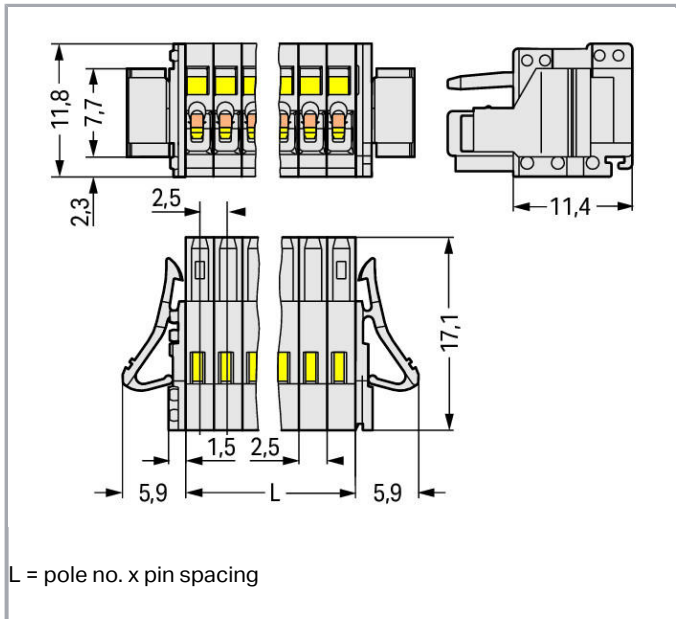

Item description

- Universal connection for all conductor types
- Easy cable pre-assembly and on-unit wiring via vertical and horizontal CAGE CLAMP® actuation
- Strain relief plates for factory and in-the-field assembly
- 100% protected against mismatching
- Coding via coding fingers

Safety information 1:

The *MULTI CONNECTION SYSTEM (MCS)* is designed without breaking capacity for compliance with DIN EN 61984. When used as intended, MCS Connectors shall not be connected/disconnected when live or under load. The circuit design should ensure header pins, which can be touched, are not live when unmated.

Data

Electrical data

Ratings per IEC/EN 60664-1

Rated voltage (III / 3)	100 V
Rated impulse voltage (III / 3)	2.5 kV
Rated voltage (III / 2)	160 V
Rated impulse voltage (III / 2)	2.5 kV
Rated voltage (II / 2)	320 V
Rated impulse voltage (II / 2)	2.5 kV

Subject to changes.

WAGO Kontakttechnik GmbH & Co. KG
 Hansastr. 27
 32423 Minden
 Phone: +49571 887-0 | Fax: +49571 887-169
 Email: info.de@wago.com | Web: www.wago.com

Do you have any questions about our products?
 We are always happy to take your call at +49 (571) 887-44222.



Rated current	6 A
Legend (ratings)	(III / 2) $\hat{=}$ Overvoltage category III / Pollution degree 2

Approvals per UL 1059

Rated voltage UL (Use Group B)	150 V
Rated current UL (Use Group B)	4 A

Approvals per CSA

Rated voltage CSA (Use Group B)	150 V
Rated current CSA (Use Group B)	4 A

Connection data

Connection technology	CAGE CLAMP [®]
Actuation type	Operating tool
Solid conductor	0.08 ... 0.5 mm ² / 28 ... 20 AWG
Fine-stranded conductor	0.08 ... 0.5 mm ² / 28 ... 20 AWG
Fine-stranded conductor with ferrule with plastic collar	0.25 ... 0.34 mm ²
Fine-stranded conductor with ferrule without plastic collar	0.25 ... 0.34 mm ²
Strip length	5 ... 6 mm / 0.2 ... 0.24 inch
No. of poles	9
Total number of connection points	9
Total number of potentials	9
Number of connection types	1
Number of levels	1
Conductor entry direction to mating direction	0°

Geometrical Data

Pin spacing	2.5 mm / 0.098 inch
Width	34.3 mm / 1.35 inch
Height	11.8 mm / 0.465 inch
Depth	17.1 mm / 0.673 inch

Plug connection

Contact type (pluggable connector)	Female connector/socket
Connector connection type	for conductors
Mismating protection	Yes

Subject to changes.

Locking of plug-in connection

locking lever

Material Data

Color	light gray
Material group	I
Insulating material	Polyamide 66 (PA 66)
Flammability class per UL94	V0
Clamping spring material	Chrome nickel spring steel (CrNi)
Contact material	Copper alloy
Contact plating	tin-plated
Fire load	0.081 MJ
Weight	4.3 g

Environmental Requirements

Limit temperature range	-60 ... +100 °C
-------------------------	-----------------

Commercial data

Product Group	3 (Multi Conn. System)
Packaging type	BOX
Country of origin	DE
GTIN	4045454215651
Customs Tariff No.	85366990990

Approvals / Certificates

UL-Approvals

Logo	Approval	Additional Approval Text	Certificate name
	UR Underwriters Laboratories Inc.	UL 1059	20190122- E45172







Compatible products

Subject to changes.

WAGO Kontakttechnik GmbH & Co. KG
 Hansastr. 27
 32423 Minden
 Phone: +49571 887-0 | Fax: +49571 887-169
 Email: info.de@wago.com | Web: www.wago.com

Do you have any questions about our products?
 We are always happy to take your call at +49 (571) 887-44222.







ferrule

	Item no.: 216-131 Ferrule; Sleeve for 0.25 mm ² / AWG 24; uninsulated; electro-tin plated	www.wago.com/216-131
	Item no.: 216-132 Ferrule; Sleeve for 0.34 mm ² / AWG 24; uninsulated; electro-tin plated	www.wago.com/216-132
	Item no.: 216-151 Ferrule; Sleeve for 0.25 mm ² / AWG 24; uninsulated; electro-tin plated	www.wago.com/216-151
	Item no.: 216-152 Ferrule; Sleeve for 0.34 mm ² / AWG 24; uninsulated; electro-tin plated	www.wago.com/216-152
	Item no.: 216-301 Ferrule; Sleeve for 0.25 mm ² / AWG 24; insulated; electro-tin plated; yellow	www.wago.com/216-301
	Item no.: 216-302 Ferrule; Sleeve for 0.34 mm ² / 22 AWG; insulated; electro-tin plated; green	www.wago.com/216-302
	Item no.: 216-321 Ferrule; Sleeve for 0.25 mm ² / AWG 24; insulated; electro-tin plated; yellow	www.wago.com/216-321
	Item no.: 216-322 Ferrule; Sleeve for 0.34 mm ² / 22 AWG; insulated; electro-tin plated; green	www.wago.com/216-322

check

	Item no.: 735-500 Test pin; 1 mm Ø; with solder connection for test wire	www.wago.com/735-500
--	--	--

tools

	Item no.: 210-251 Operating tool; for MCS MICRO & MINI with CAGE CLAMP® connection; yellow	www.wago.com/210-251
	Item no.: 210-719 Operating tool; Blade: 2.5 x 0.4 mm; with a partially insulated shaft	www.wago.com/210-719
	Item no.: 233-331 Operating tool; insulated; yellow	www.wago.com/233-331
	Item no.: 233-332 Operating tool; made of insulating material	www.wago.com/233-332
	Item no.: 233-335 Operating tool	www.wago.com/233-335
	Item no.: 733-130 Operating tool; loose; natural	www.wago.com/733-130
	Item no.: 733-191 Operating tool; loose; yellow	www.wago.com/733-191

Subject to changes.



Strain relief plate



Item no.: 734-128

Strain relief plate; 12.5 mm wide; light gray

www.wago.com/734-128

Marking accessories

Item no.: 210-331/250-202

Marking strips; as a DIN A4 sheet; MARKED; 1-16 (400x); Height of marker strip: 2.3 mm/0.091 in; Strip length 182 mm; Horizontal marking; Self-adhesive; white

www.wago.com/210-331/250-202

Item no.: 210-331/250-204

Marking strips; as a DIN A4 sheet; MARKED; 17-32 (400x); Height of marker strip: 2.3 mm/0.091 in; Strip length 182 mm; Horizontal marking; Self-adhesive; white

www.wago.com/210-331/250-204

Item no.: 210-331/250-206

Marking strips; as a DIN A4 sheet; MARKED; 33-48 (400x); Height of marker strip: 2.3 mm/0.091 in; Strip length 182 mm; Horizontal marking; Self-adhesive; white

www.wago.com/210-331/250-206

Item no.: 210-331/250-207

Marking strips; as a DIN A4 sheet; MARKED; 1-48 (100x); Height of marker strip: 2.3 mm/0.091 in; Strip length 182 mm; Horizontal marking; Self-adhesive; white

www.wago.com/210-331/250-207

Downloads

Documentation

Additional Information

Technical explanations	2019-04-03	pdf 3.6 MB	Download
------------------------	------------	---------------	----------

CAD/CAE-Data

CAD data

2D/3D Models 733-109/037-000	URL	Download
------------------------------	-----	----------

Installation Notes

Protected Against Mismatching

Subject to changes.

WAGO Kontakttechnik GmbH & Co. KG
 Hansastr. 27
 32423 Minden
 Phone: +49571 887-0 | Fax: +49571 887-169
 Email: info.de@wago.com | Web: www.wago.com

Do you have any questions about our products?
 We are always happy to take your call at +49 (571) 887-44222.

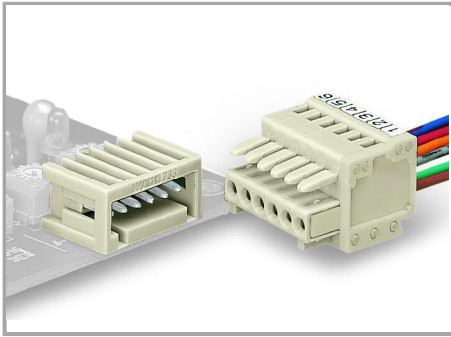

Male headers and female connectors are 100 % protected against mismatching.

Only mating halves with the same pole number can be connected.

Inserting a conductor

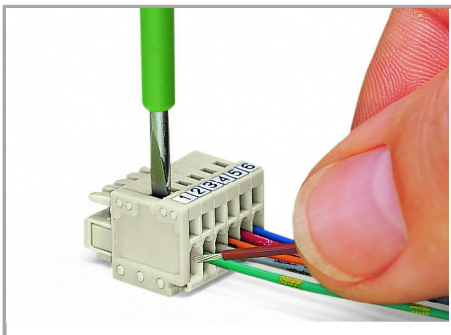

Inserting a conductor via (2.5 x 0.4) mm screwdriver. Operation is performed perpendicular to conductor entry.

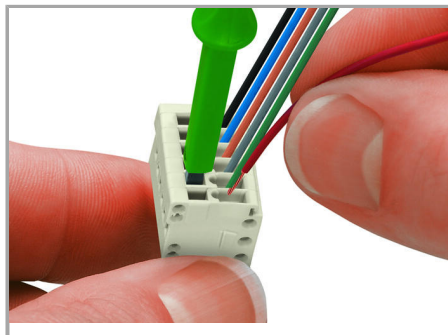

Inserting a conductor via screwdriver (233-335) – CAGE CLAMP® actuation parallel to conductor entry.

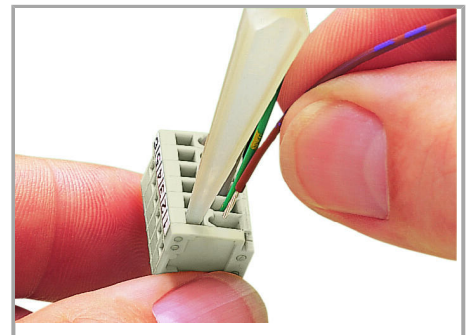

Subject to changes.

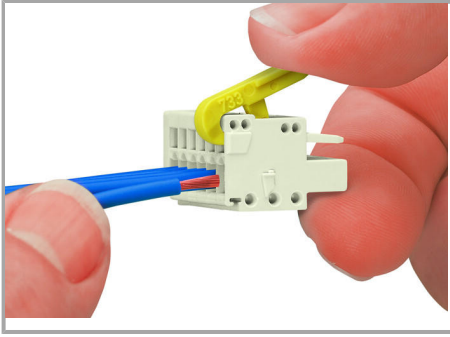

Inserting a conductor via 733-191 Operating Lever.

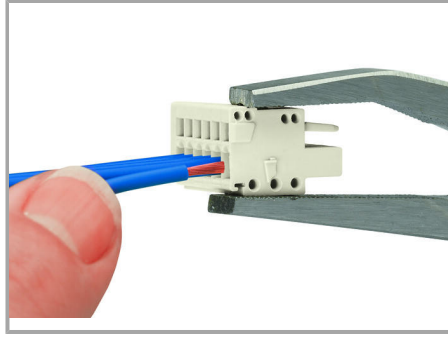

Inserting a conductor via 210-251 Operating Tool.

Coding

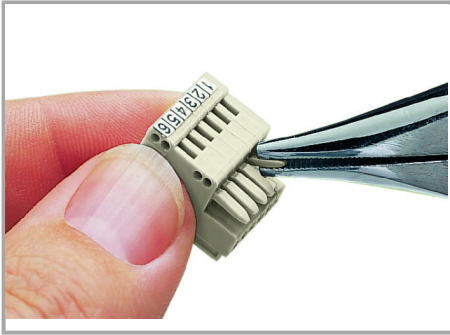

Coding a female connector – removing coding finger(s).

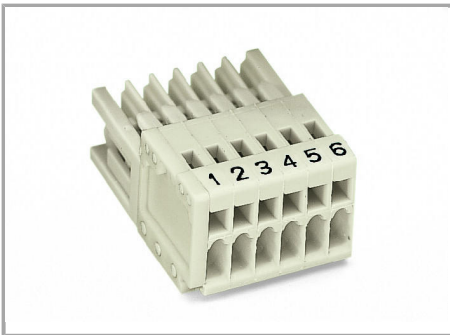

Assembly

Subject to changes.

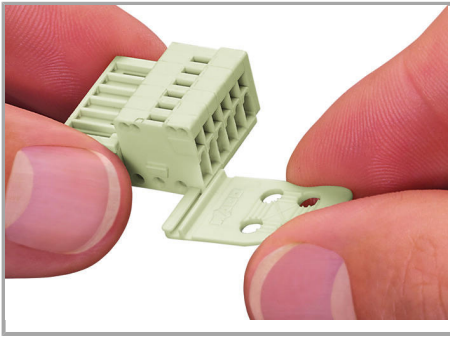

Strain relief plates for factory or in-the-field assembly.

Testing

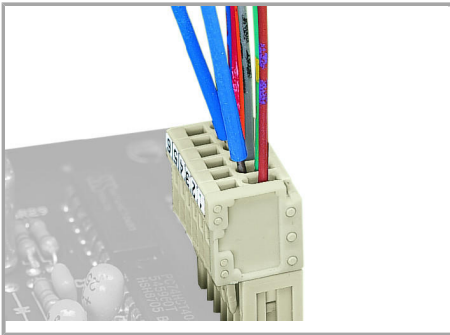

Testing via 1 mm Ø test pin (735-500) – touch contact.

Locking

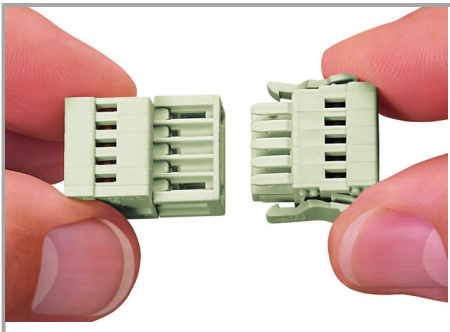

Locking levers prevent accidental disconnection.

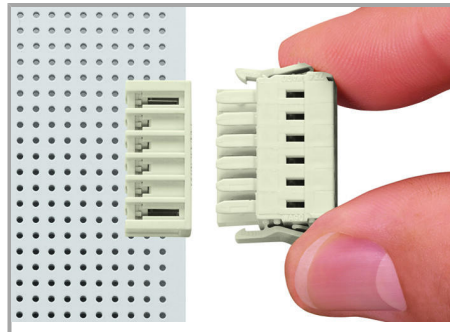

Locking levers prevent accidental disconnection.

Product family

Subject to changes.



<i>MCS</i> MICRO

[Learn more about the product family.](#)

[Show all products from the family](#)

Subject to changes.

WAGO Kontakttechnik GmbH & Co. KG
Hansastr. 27
32423 Minden
Phone: +49571 887-0 | Fax: +49571 887-169
Email: info.de@wago.com | Web: www.wago.com

Do you have any questions about our products?
We are always happy to take your call at +49 (571) 887-44222.

X-ON Electronics

Largest Supplier of Electrical and Electronic Components

Click to view similar products for [Pluggable Terminal Blocks](#) category:

Click to view products by [Wago](#) manufacturer:

Other Similar products are found below :

[57.404.7553](#) [57.504.0053.7](#) [57.510.0053](#) [57.910.6153](#) [01.112.1453](#) [CTB932VE/6](#) [MC 1.5/ 6-ST-3.5 GY AU](#) [ET02015000J0G](#) [734-104](#) [734-302](#) [734-304](#) [8-141-P](#) [FKCT 2.5/ 3-ST KMGY](#) [860505](#) [860508](#) [860516](#) [860810](#) [861908](#) [GBPACX-12](#) [93.731.4953.0](#) [PV05-5,08-K](#) [PVP02-5,00](#) [PVP04-3,50](#) [PVS02-5,00](#) [1-1986160-3](#) [H-10](#) [1546228-5](#) [ELFP03110](#) [ELVP03100](#) [ELXH03100](#) [ELXH071G0E](#) [ELXP041G0](#) [ELXT046G0](#) [1700101](#) [1700410](#) [1700425](#) [1703176](#) [1703243](#) [1705229](#) [1710175](#) [1714537](#) [1717806](#) [1719600](#) [1728941](#) [1729386](#) [1734692](#) [1734795](#) [1736036](#) [1740194](#) [1740291](#)