

# Electronic WAGO Circuit Breaker

1-channel; 24 VDC; 0.5 ... 4 A; NEC Class 2

787-3861/004-1020

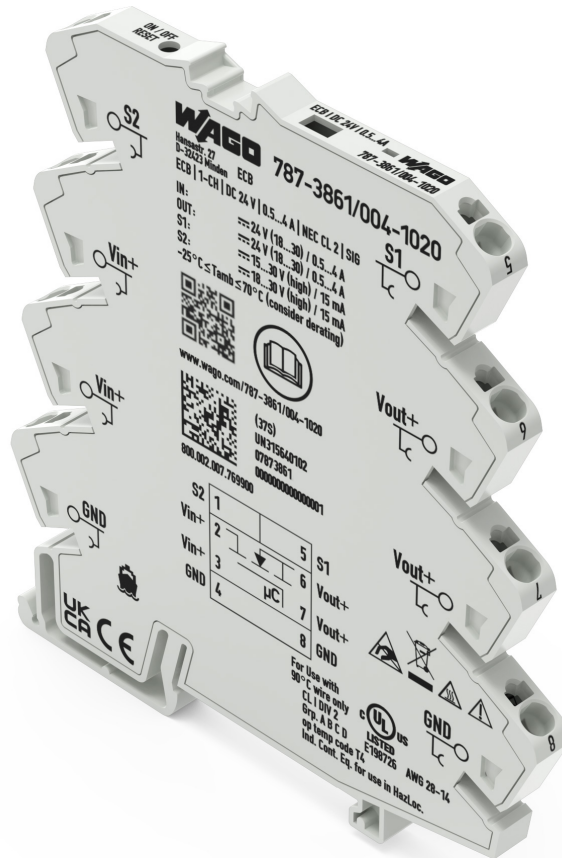

© 2024 WAGO GmbH & Co. KG  
All rights reserved.

**WAGO GmbH & Co. KG**

Hansastraße 27  
D - 32423 Minden

Phone: +49 571/887 – 0  
Fax: +49 571/887 – 844169  
E-Mail: ✉ [info@wago.com](mailto:info@wago.com)  
Internet: 🌐 [www.wago.com](http://www.wago.com)

**Technical Support**

Phone: +49 571/887 – 44555  
Fax: +49 571/887 – 844555  
E-Mail: ✉ [support@wago.com](mailto:support@wago.com)

Every conceivable measure has been taken to ensure the accuracy and completeness of this documentation. However, as errors can never be fully excluded, we always appreciate any information or suggestions for improving the documentation.

E-Mail: ✉ [documentation@wago.com](mailto:documentation@wago.com)

We wish to point out that the software and hardware terms as well as the trademarks of companies used and/or mentioned in the present manual are generally protected by trademark or patent.

**WAGO is a registered trademark of WAGO Verwaltungsgesellschaft mbH.**

# Table of Contents

|  |           |
|--|-----------|
| <b>1 Provisions</b>                              | <b>5</b>  |
| 1.1 Intended Use                                 | 5         |
| 1.2 Typographical Conventions                    | 6         |
| 1.3 Definitions                                  | 7         |
| 1.4 Legal Information                            | 8         |
| <b>2 Safety</b>                                  | <b>9</b>  |
| 2.1 General Safety Regulations                   | 9         |
| 2.2 Electrical Safety                            | 9         |
| 2.3 Mechanical Safety                            | 9         |
| 2.4 Thermal Safety                               | 10        |
| 2.5 Indirect Safety                              | 10        |
| <b>3 Properties</b>                              | <b>11</b> |
| 3.1 View   | 11        |
| 3.2 Connections                                  | 12        |
| 3.3 Indicators                                   | 12        |
| 3.4 Controls                                     | 13        |
| 3.4.1 Current Dial                               | 13        |
| 3.4.2 Button                                     | 13        |
| 3.5 Technical Data                               | 14        |
| 3.5.1 Product                                    | 14        |
| 3.5.2 Input                                      | 14        |
| 3.5.3 Output                                     | 14        |
| 3.5.4 Safety                                     | 15        |
| 3.5.5 Connection Technology                      | 15        |
| 3.5.6 Environmental Requirements                 | 16        |
| 3.6 Guidelines, approvals and standards          | 16        |
| 3.6.1 Regulations and Standards                  | 16        |
| 3.6.2 Approvals                                  | 17        |
| <b>4 Functions</b>                               | <b>18</b> |
| 4.1 Tripping in the Event of Overload            | 18        |
| 4.2 Conditions                                   | 22        |
| 4.3 Undervoltage and Overvoltage Detection       | 23        |
| 4.4 Capacitive Load                              | 24        |
| 4.5 On Delay                                     | 24        |
| 4.6 Control Input S1 and Signal Output S2        | 25        |
| 4.7 Distributing and Multiplying a Potential     | 26        |
| 4.7.1 Commoning                                  | 27        |
| 4.7.2 Potential Distribution Module              | 27        |
| 4.8 Channel lock                                 | 27        |
| <b>5 Planning</b>                                | <b>28</b> |
| 5.1 Safety Measures at the Installation Location | 28        |
| 5.2 EMC Installation                             | 28        |
| 5.3 DIN-Rail Characteristics                     | 28        |
| 5.4 Connection Examples                          | 29        |

---

|           |                                       |           |
|-----------|---------------------------------------|-----------|
| <b>6</b>  | <b>Transport and Storage</b> .....    | <b>32</b> |
| <b>7</b>  | <b>Installation and Removal</b> ..... | <b>33</b> |
| 7.1       | DIN-35 Rail .....                     | 33        |
| <b>8</b>  | <b>Diagnostics</b> .....              | <b>35</b> |
| 8.1       | Diagnostics via Indicators .....      | 35        |
| <b>9</b>  | <b>Configuration</b> .....            | <b>36</b> |
| 9.1       | Configuration via Button .....        | 36        |
| <b>10</b> | <b>Decommissioning</b> .....          | <b>38</b> |
| 10.1      | Disposal and Recycling .....          | 38        |
| <b>11</b> | <b>Appendix</b> .....                 | <b>39</b> |
| 11.1      | Power Supplies .....                  | 39        |
| 11.2      | Protected Rights .....                | 39        |

# 1 Provisions

This document applies to the following product:

787-3861/004-1020 (Electronic Circuit Breaker (ECB))

|                     |   |
|---------------------|---|
| Product detail page | <a href="https://www.wago.com/787-3861/004-1020">www.wago.com/787-3861/004-1020</a> |
|---------------------|---|

The product must only be installed and operated in accordance with the operating instructions. Knowledge of the operating instructions is required for proper use. You can find all documents and information on the detailed product page.

## 1.1 Intended Use

The product reliably protects load circuits against short circuits and overloads.

The product is an open type device and is designed for installation in an additional enclosure.

- The product is designed for use in dry indoor rooms.
- Operation of the products in industrial area is permitted.
- The product meets the EMC requirements for the residential, office and commercial area as well as small business, if the product used complies with the required emissions of interference (emission limits).
- Operation of the product in other application areas is only permitted when corresponding approvals and labeling are present.

### Improper Use

Improper use of the product is not permitted. Improper use occurs especially in the following cases:

- Non-observance of the intended use
- Use without protective measures in an environment in which moisture, salt water, salt spray mist, dust, corrosive fumes, gases, direct sunlight or ionizing radiation can occur
- Use of the product in areas with special risk that require continuous fault-free operation and in which failure of or operation of the product can result in an imminent risk to life, limb or health or cause serious damage to property or the environment (such as the operation of nuclear power plants, weapons systems, aircraft and motor vehicles)

### Warranty and Liability

The provisions of the latest WAGO General Terms and Conditions of Deliveries and Services (GTC) apply as well as the Software License Terms for Standard Software (SW-License) applicable to software products und software embedded in WAGO hardware products, both available at: [www.wago.com](https://www.wago.com).

In particular, the warranty is void if:

- The product is improperly used.
- The deficiency (hardware and software configurations) is due to special instructions.
- Modifications to the hardware or software have been made by the user or third parties that are not described in this documentation and that has contributed to the fault.

Individual agreements always have priority.

## Obligations of Installers/Operators

The installers and operators bear responsibility for the safety of an installation or a system assembled with the product. The installer/operator is responsible for the proper installation and safety of the system. All laws, standards, guidelines, local regulations and accepted technology standards and practices applicable at the time of installation, and the instructions in the the products' Instructions for Use, must be complied with. In addition, the installment requirements for licensing must be observed. In the event of non-compliance, the product may not be operated within the scope of the approval.

## 1.2 Typographical Conventions





### Number Notation

|             |                                   |
|-------------|-----------------------------------|
| 100         | Decimals: Normal notation         |
| 0x64        | Hexadecimals: C-notation          |
| '100'       | Binary: In single quotation marks |
| '0110.0100' | Nibbles separated by a period     |

### Text Formatting

|               |   |
|---------------|---|
| <i>italic</i> | Names of paths or files                         |
| <b>bold</b>   | Menu items, entry or selection fields, emphasis |
| Code          | Sections of program code                        |
| >             | Selection of a menu point from a menu           |
| "Value"       | Value entries                                   |
| [F5]          | Identification of buttons or keys               |

### Cross References / Links

|   |   |
|---|---|
|  | Cross references/links to a topic in a document |
|  | Cross references / links to a separate document |
|  | Cross references / links to a website           |
|  | Cross references / links to an email address    |

### Sequence of Action

- ✓ This symbol identifies a precondition.
- 1. Action step
- 2. Action step
  - ⇒ This symbol identifies an intermediate result.
  - ⇒ This symbol identifies the result of an action.
- Individual action step

### Lists

- Lists, first level
  - Lists, second level

## Figures

Figures in this documentation are for better understanding and may differ from the actual product design.

## Warning Messages

### **DANGER**

#### Type and source of hazard

Indicates an imminently hazardous situation which, if not avoided, will result in death or serious injury.

- Action step to reduce risk

### **WARNING**

#### Type and source of hazard

Indicates a potentially hazardous situation which, if not avoided, could result in death or serious injury.

- Action step to reduce risk

### **CAUTION**

#### Type and source of hazard

Indicates a potentially hazardous situation which, if not avoided, may result in minor or moderate injury.

- Action step to reduce risk

### **NOTICE**

#### Type and source of malfunction (property damage only)

Indicates a potentially hazardous situation which, if not avoided, may result in damage to property.

- Action step to reduce risk

## Information Notices

### **Note**

#### Information

Indicates information, clarifications, recommendations, referrals, etc.

## 1.3 Definitions

This Product Manual uses the terms “switched on,” “switched off” and “triggered.” To clearly distinguish these terms, they are explained below:

Table 1: Definitions

| Item         | Definition  |
|--------------|---|
| Switched on  | The user has manually activated the product via the button or a corresponding signal at the control input. The load circuit is closed; current is flowing.              |
| Switched off | The user has manually deactivated the product via the button or a corresponding signal at the control input. The load circuit is open; the current flow is interrupted. |
| Tripped      | The product's electronics have been triggered by overcurrent, undervoltage or overvoltage. The load circuit is open; the current flow is interrupted.                   |

## 1.4 Legal Information

### Intellectual property

The intellectual property of this document belongs to WAGO GmbH & Co. KG. The reproduction and distribution of its content (in whole or in part) is prohibited, unless otherwise provided by statutory provisions, written agreements or this document. In case of doubt, the written consent of WAGO GmbH & Co. KG must be obtained in advance.

Third-party products are always mentioned without any reference to patent rights. WAGO GmbH & Co. KG, or the manufacturer of third-party products, retains all rights regarding patent, utility model or design registration.

Third-party trademarks are referred to in the product documentation. The “®” and “™” symbols are omitted hereinafter. The trademarks are listed in the Appendix: [🔒 Protected Rights \[► 39\]](#).

### Subject to Change

The instructions, guidelines, standards, etc., in this manual correspond to state of the art at the time the documentation was created and are not subject to updating service. The installer and operator bear sole responsibility to ensure they are complied with in their currently applicable form. WAGO GmbH & Co. KG retains the right to carry out technical changes and improvements of the products and the data, specifications and illustrations of this manual. All claims for change or improvement of products that have already been delivered – excepting change or improvement performed under guarantee agreement – are excluded.



## 2 Safety

### 2.1 General Safety Regulations

- This documentation is part of the product. Therefore, retain the documentation during the entire service life of the product. Pass on the documentation to any subsequent user of the product. In addition, ensure that any supplement to this documentation is included, if necessary.
- The product must only be installed and put into operation by qualified electrical specialists per EN 50110-1/-2 and IEC 60364.
- Comply with the laws, standards, guidelines, local regulations and accepted technology standards and practices applicable at the time of installation.

### 2.2 Electrical Safety

- High voltage can cause electric shock or burns! Disconnect all power sources from the product before performing any installation, repair or maintenance.
- Make sure the product does not carry any voltage before starting work.

#### Power Supply

- For non-hazardous active voltage per EN/UL/IEC 61010-1, SELV/PELV power supplies shall be used.
- Connecting impermissible current or frequency values may destroy the product.
- Provide suitable disconnect and overcurrent protection on the system side. The protection device must be located near the product where it can be operated. The **OFF** position must be clearly marked on the protection device.

#### Cables

- Always design the connection cables for the maximum anticipated current load.
- High currents and the inherent heat generated by the product can cause additional heat generation at the clamping point. Plan for a correspondingly higher temperature range for the connecting cables, or reduce inherent heat by selecting larger conductor cross-sections.
- Only one conductor may be connected to each connection point (e.g., CAGE CLAMP® connection).

#### Grounding/Protection/Fuses

- When handling the product, please ensure that environmental factors (personnel, work space and packaging) are properly equalized. Do not touch any conducting parts.

### 2.3 Mechanical Safety

- Before startup, please check the product for any damage that may have occurred during shipping. Do not put the product into operation in the event of mechanical damage.
- Do not open the product housing.
- Avoid conductive contamination.

## 2.4 Thermal Safety

- The surface of the housing heats up during operation. Under special conditions (e.g., in the event of a fault or increased surrounding air temperature), touching the product may cause burns. Allow the product to cool down before touching it.
- The temperature inside the additional enclosure must not exceed the ambient temperature permitted for the mounted product.
- Cooling of the product must not be impaired. Ensure that the air circulation is unobstructed.

## 2.5 Indirect Safety

- Only use a dry or cloth or a clothed dampened with water to clean the product. Do not use cleaning agents, e.g., abrasive cleaners, alcohols or acetone.
- Do not allow the product to come into contact with ketones (e.g., acetone) or chlorinated hydrocarbons (e.g., dichloromethane) under any circumstances.
- Do not use hard objects that could cause scratches for cleaning.
- Clean tools and materials are imperative for handling the product.
- The products are not resistant to materials having seeping and insulating properties such as aerosols, silicones and triglycerides (found in some hand creams). If these substances occur in the environment of the products, install the products in an additional housing that is also resistant to these substances.
- Replace any defective or damaged devices.
- Observe possible different technical specifications for mounting that does not correspond to the nominal mounting position.
- Only use accessories authorized by WAGO.

## 3 Properties

The product reliably protects load circuits against short circuits and overloads. The 24 VDC input voltage can be variably protected by current values from 0.5 ... 4 A.

| Version           | Fuse protection |
|-------------------|-----------------|
| 787-3861/004-1020 | 0.5 ... 4 A     |

The electronics can accommodate brief current peaks.

In the event of a short circuit or overloading, the individual channel is de-energized after a defined tripping time.

The product has a control input and signal output.

- **Control input (S1):** This can be used to switch the channel on and off.
- **Signal output (S2):** This can be used to read out the operating statuses.

### 3.1 View

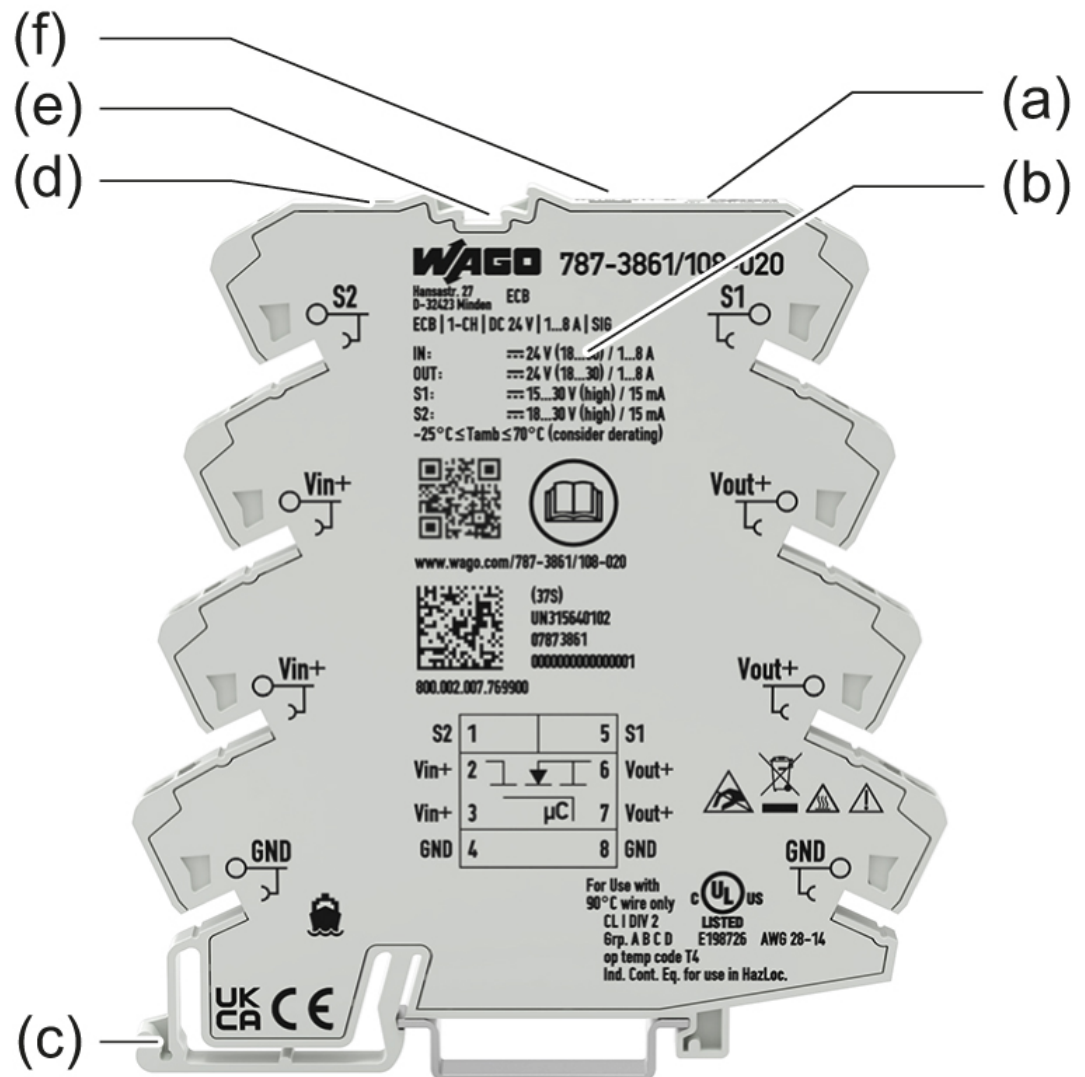

Figure 1: Example View

|   |                       |
|---|-----------------------|
| a | Status LED            |
| b | Technical Data        |
| c | Snap-in mounting foot |
| d | Button                |
| e | Marking Field         |
| f | Current dial          |

### 3.2 Connections

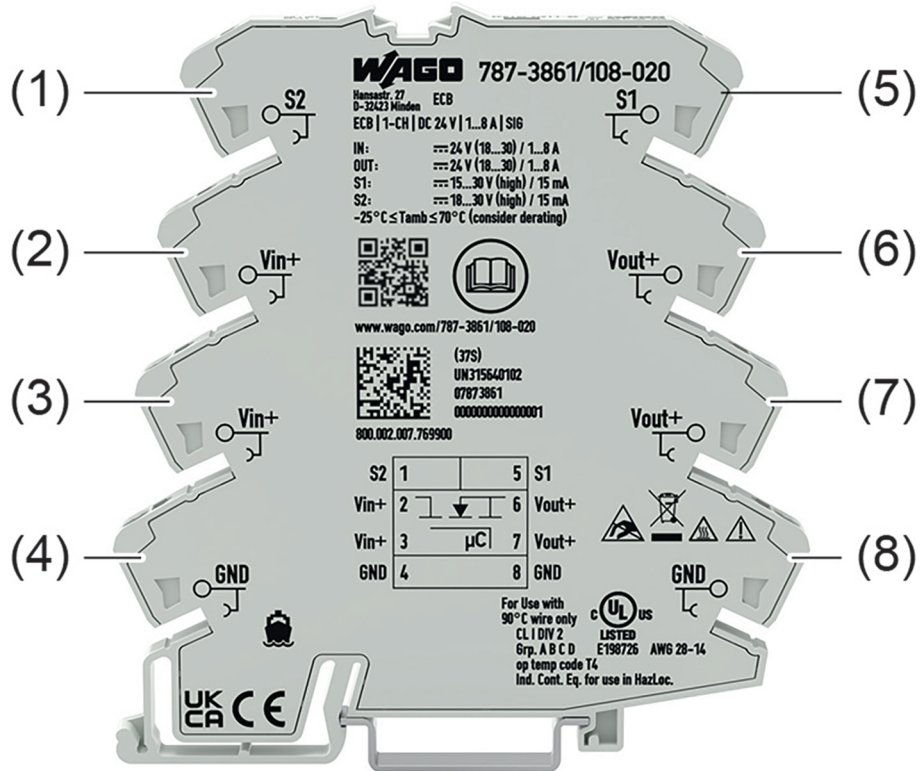

Figure 2: Connections (Example View)

|   |                    |
|---|--------------------|
| 1 | S2 (signal output) |
| 2 | Vin+               |
| 3 | Vin+               |
| 4 | GND                |
| 5 | S1 (control input) |
| 6 | Vout+              |
| 7 | Vout+              |
| 8 | GND                |

### 3.3 Indicators

The electronic circuit breaker has a status LED (a).

- **Status LED:** The LED indicates the current operating status of the channel (see [Diagnosics via Indicators \[▶ 35\]](#)) and the current configuration status (see [Configuration via Button \[▶ 36\]](#)).

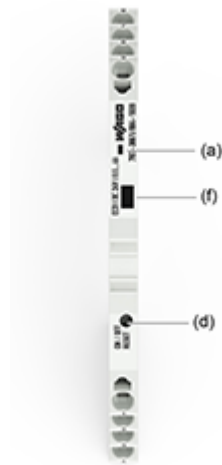

Figure 3: Indicators

|     |              |
|-----|--------------|
| (a) | Status LED   |
| (f) | Current dial |
| (d) | Button       |

## 3.4 Controls

### 3.4.1 Current Dial

The current dial is used to set the current value:

- Turning it upward increases the current value.
- Turning it downward decreases the current value.

The current value can be read off the current dial scale.

| Settings Option | Description   |
|-----------------|---|
| 0.5 ... 4 A     | Adjustable current value (step sequence: 0.5)             |
| L               | channel lock (see <a href="#">🔗 Channel lock [▶ 27]</a> ) |
| C               | channel lock (see <a href="#">🔗 Channel lock [▶ 27]</a> ) |

### 3.4.2 Button

Table 2: Basic Functions of the Button

| Button                    | Description  |
|---------------------------|--|
| Press                     | During operation:<br>Switches channel on and off   |
|                           | In the event of error:<br>Resets channel   |
| Hold down for > 3 seconds | Requirement: The channel is switched off.<br>The product switches to configuration mode. |

For more information on configuration mode, see [🔗 Configuration via Button \[▶ 36\]](#).

## 3.5 Technical Data

### 3.5.1 Product

Table 3: Technical Data – Product

| Property   | Value  |
|--|--|
| Dimensions<br>Width x Depth x Height from upper-edge of DIN-rail | 6 mm x 94 mm x 97,8 mm;<br>0,236 in x 3,701 in x 3,85 in |
| Weight   | 53,6 g   |
| Degree of protection   | IP20   |

### 3.5.2 Input

Table 4: Technical Data – Input

| Property  | Value  |
|---|--|
| Nominal input voltage   | 24 VDC   |
| Input voltage range   | 18 ... 30 VDC  |
| Required input voltage at which the channel is switched on (activation threshold) | 20 VDC   |
| Input voltage at which the channel is tripped (trip level)                        | 18 VDC (a possible undervoltage is allowed for approx. 10 ms.) |
| Maximum continuous current for the device   | 0.5 ... 4 A  |
| Overvoltage protection  | 33 V (suppressor diode at input)                               |
| Closed current for open-circuit operation at 24 V <sup>1)</sup>                   | < 15 mA  |
| Power loss for open-circuit operation at 24 V <sup>1)</sup>                       | < 400 mW   |

<sup>1)</sup> Default setting triggered and switched off; see [🔗 Configuration via Button \[▶ 36\]](#).

Table 5: Technical Data – Control Input

| Property      | Voltage Level | Value  |
|---------------|---------------|--|
| Control Input |               | Non-isolated 24 VDC input (relative to the device GND input) |
|               | High level    | Minimum 15 VDC, maximum 30 VDC                               |
|               | Low level     | Minimum 0 VDC, maximum 5 VDC                                 |

### 3.5.3 Output

Table 6: Technical Data – Output

| Property  | Value  |
|---|--|
| Nominal output voltage  | 24 VDC   |
| Trip current  | 0.5 A; 1 A; 1.5 A; 2 A; 2.5 A; 3 A; 3.5 A; 4 A   |
| Voltage drop between input and output                                 | ≤ 40 mV (0.5 A); ≤ 80 mV (1 A); ≤ 120 mV (1.5 A); ≤ 160 mV (2 A); ≤ 200 mV (2.5 A); ≤ 240 mV (3 A); ≤ 280 mV (3.5 A); ≤ 320 mV (4 A) |
| Wait time after a channel has tripped (temperature returns to normal) | At least 5 s (depending on the trip current)   |
| Efficiency, typ.  | 98 % (at IN ≥ 0.5 A constant current)  |
| Switch-on capacity  | < 7000 μF <sup>1) 2)</sup>   |
| Integrated fuse   | T 4 A  |
| On delay  | Minimum 0 ms, maximum 500 ms   |
| Maximum feedback voltage  | Maximum 33 VDC   |
| Parallel connection   | Prohibited   |

| Property       | Value      |
|----------------|------------|
| Series circuit | Prohibited |

<sup>1)</sup> The power supply must be able to deliver the maximum required power without the voltage falling below 20 VDC.

<sup>2)</sup> Verified connectable load capacities depend on the power supply used; see [Power Supplies \[▶ 39\]](#).

Table 7: Technical Data – Signal Output

| Property      | Voltage Level | Value  |
|---------------|---------------|--|
| Signal output |               | Non-isolated 24 VDC output, short-circuit-protected, can be commoned across max. 10 devices (relative to the device GND input) |
|               | High level    | 18 ... 30 V at maximum current load 15 mA  |

### See also

[Power Supplies \[▶ 39\]](#)

### 3.5.4 Safety

Table 8: Technical Data – Safety

| Property                          | Value                                  |
|-----------------------------------|--|
| Rated voltage                     | 300 V                                  |
| Protection type                   | IP20                                   |
| <b>Insulation coordination UL</b> |  |
| Overvoltage category              | II                                     |
| Pollution degree                  | 2                                      |
| Type pf insulation <sup>1)</sup>  | Functional insulation                  |
| Dielectric strength               | 1.5 kVDC (1 min.)                      |
| <b>Insulation coordination</b>    |  |
| Overvoltage category              | II                                     |
| Pollution degree                  | 2                                      |
| Type pf insulation <sup>1)</sup>  | Reinforced insulation (safe isolation) |
| Dielectric strength               | 3 kVDC (1 min.)                        |

<sup>1)</sup> Between adjacent products of the same type.

### 3.5.5 Connection Technology

Table 9: Technical Data – Connection Technology

| Parameters                      | Value  |
|---------------------------------|--|
| Connection Technology           | Push-in CAGE CLAMP®                          |
| Solid "s" <sup>1)</sup>         | 0.08 ... 2.5 mm <sup>2</sup> / 26 ... 14 AWG |
| Fine-stranded "F" <sup>1)</sup> | 0.34 ... 2.5 mm <sup>2</sup> / 22 ... 14 AWG |
| Strip length                    | 9 ... 10 mm / 0.35 ... 0.39 in               |

<sup>1)</sup> The conductor temperature can be up to 90 °C. Use only conductors that can withstand the anticipated temperature.

### 3.5.6 Environmental Requirements

#### **i Note**

**At nominal current  $\leq 4$  A there is no ambient temperature restriction!**

For products with nominal current  $\leq 4$  A, there is no restriction of the ambient temperature range in the form of derating. The devices in the specified range  $-25 \dots +70$  °C can be fully used.

- Restrictions in the form of derating must be taken into account in accordance with the following tables for nominal current of 4 A or more.

Table 10: Technical Data – Environmental Conditions

| Parameter                      | Value   |
|--------------------------------|---|
| Ambient temperature, operation | $-25 \dots +70$ °C                            |
| Ambient temperature, storage   | $-40$ °C $\dots$ $+85$ °C                     |
| Relative humidity              | 10 $\dots$ 95 % (no condensation permissible) |
| Elevation above sea level      | 2000 m  |

Table 11: Technical Data – Mounting Positions and Ambient Temperatures in the Control Cabinet

| Mounting Position in Control Cabinet            | Ambient Temperatures |                    |                    |
|---|----------------------|--------------------|--------------------|
|   | 0.5 ... 4 A          | 5 ... 6 A          | 7 ... 8 A          |
| Stand-alone                                     | $-25 \dots +70$ °C   | $-25 \dots +70$ °C | $-25 \dots +70$ °C |
| Arranged in series (series of 5 <sup>1)</sup> ) | $-25 \dots +70$ °C   | $-25 \dots +60$ °C | $-25 \dots +35$ °C |

Table 12: Technical Data – Horizontal Mounting Positions and Ambient Temperatures <sup>2)</sup>

| Mounting Position horizontal             | Ambient Temperatures 7 ... 8 A |
|--|--------------------------------|
| Horizontal stand-alone                   | $-25 \dots +70$ °C             |
| Horizontal (series of 3 <sup>1)</sup> )  | $-25 \dots +40$ °C             |
| Horizontal (series of 5 <sup>1)</sup> )  | $-25 \dots +35$ °C             |
| Horizontal (series of 9 <sup>1)</sup> )  | $-25 \dots +15$ °C             |
| Horizontal (series of 13 <sup>1)</sup> ) | $-25 \dots +10$ °C             |
| Horizontal (series of 15 <sup>1)</sup> ) | $-25 \dots +5$ °C              |

<sup>1)</sup> Series: Same devices with the same load.

<sup>2)</sup> Determined by simulation.

## 3.6 Guidelines, approvals and standards

### 3.6.1 Regulations and Standards

Table 13: Standards and Regulations

| Name   | Standard       |
|--|----------------|
| EU EMV Directive   | 2014/30/EU     |
| Safety requirements for electrical equipment for measurement, control, and laboratory use<br>Part 2-201: Particular requirements for control equipment | EN 61010-2-201 |



| Name   | Standard         |
|--|------------------|
| Electromagnetic compatibility (EMC)<br>Part 6-2: Generic standards<br>Immunity for industrial environments   | DIN EN 61000-6-2 |
| Electromagnetic compatibility (EMC) –<br>Part 6-3: Generic standards –<br>Emission standard for residential, commercial and<br>light-industrial environments | DIN EN 61000-6-3 |

For additional information, visit [www.wago.com](https://www.wago.com).

### 3.6.2 Approvals

The applicable guidelines, approvals and standards for the product can be found on the product detail page at: [www.wago.com/787-3861/004-1020](https://www.wago.com/787-3861/004-1020).

# 4 Functions

## 4.1 Tripping in the Event of Overload

**Note**

**Wait for temperature to return to normal!**

If a channel has tripped due to a short circuit or overload, it is necessary to wait until the temperature returns to its normal range before switching the channel back on.

The product checks whether the output current is greater than the nominal current setting. As soon as the output current exceeds this nominal current, the channel is switched off. The tripping time depends on the magnitude of the overcurrent. The following figures show the corresponding tripping times:

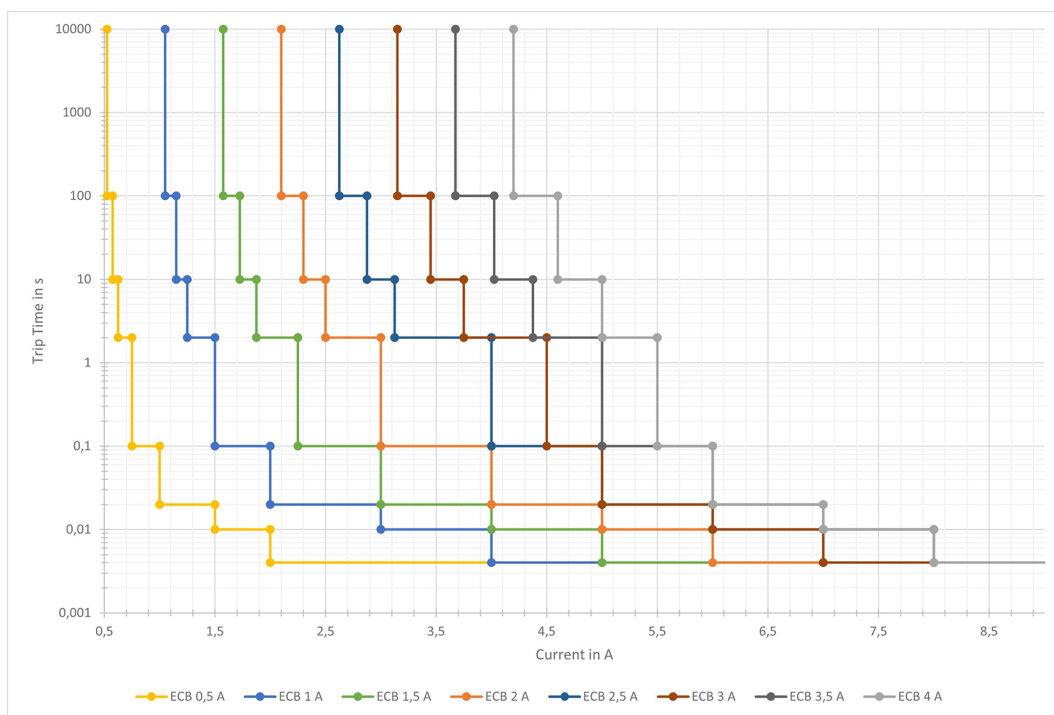

Figure 4: Trip Characteristic – Complete Overview

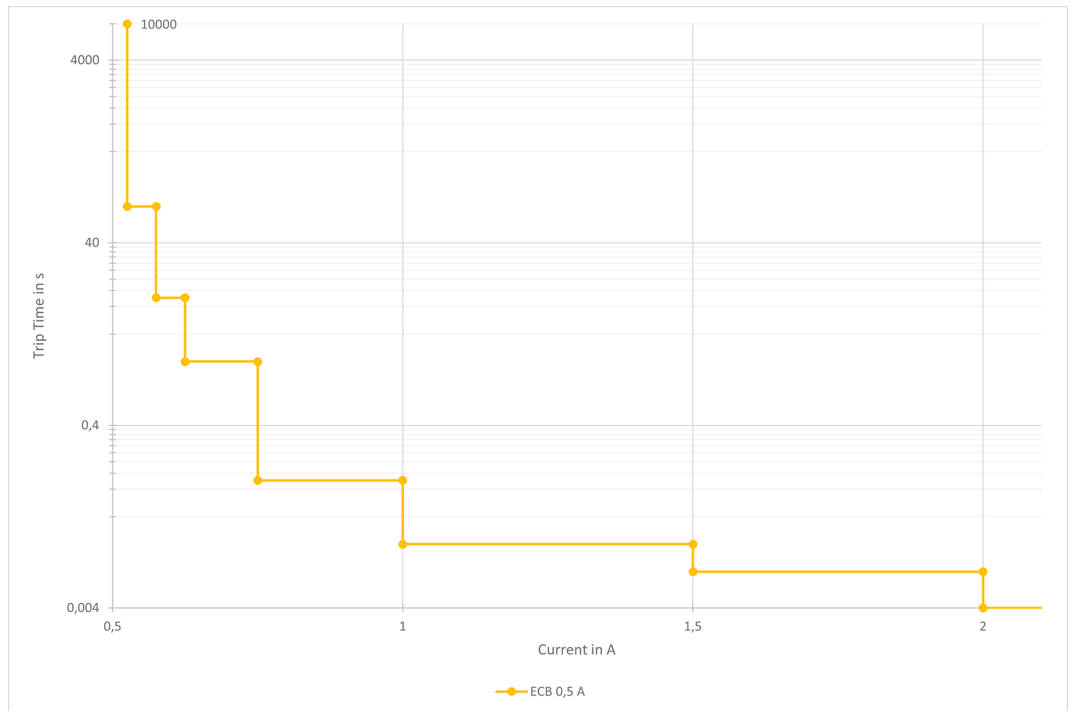

Figure 5: Trip Characteristic – 0.5 A

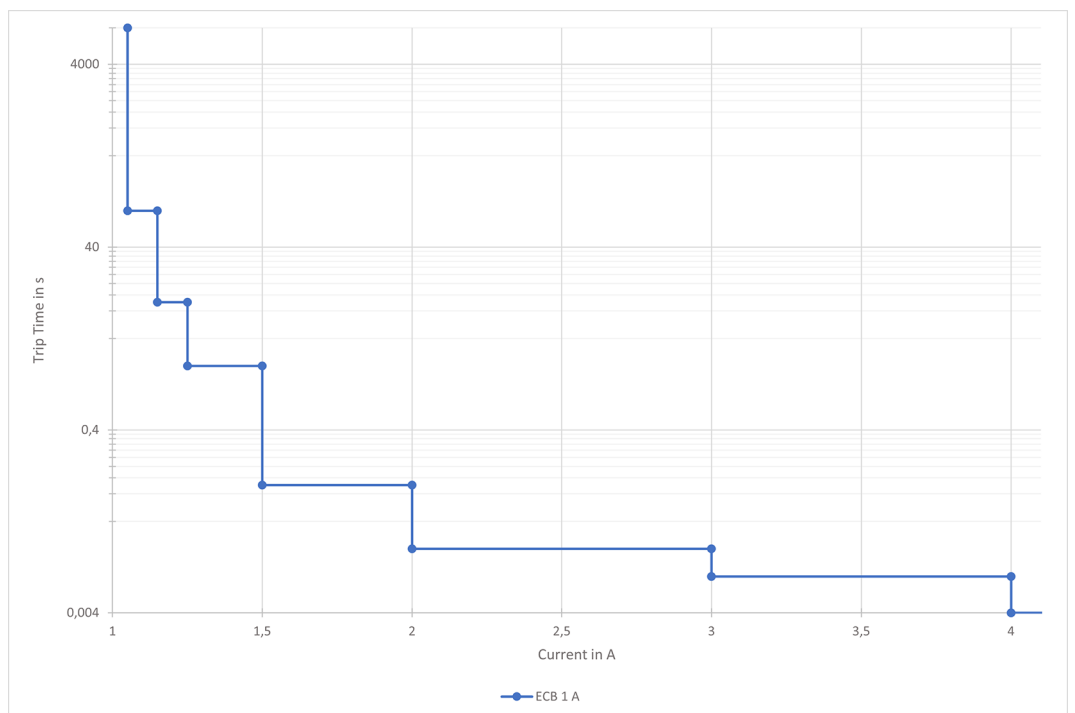

Figure 6: Trip Characteristic – 1 A

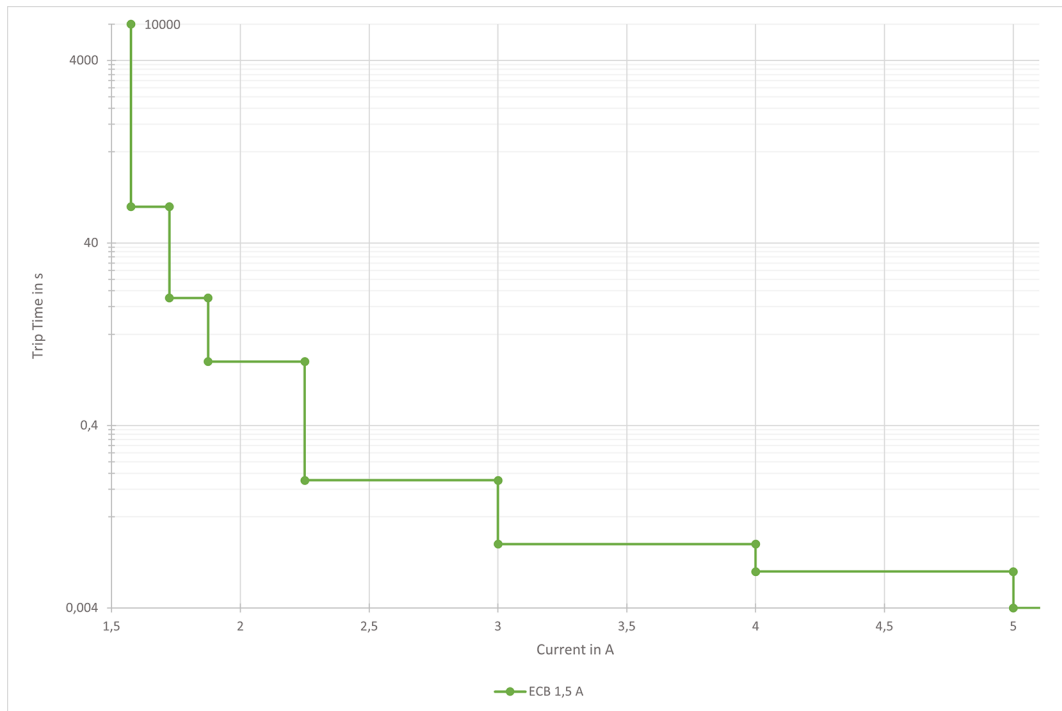

Figure 7: Trip Characteristic – 1.5 A

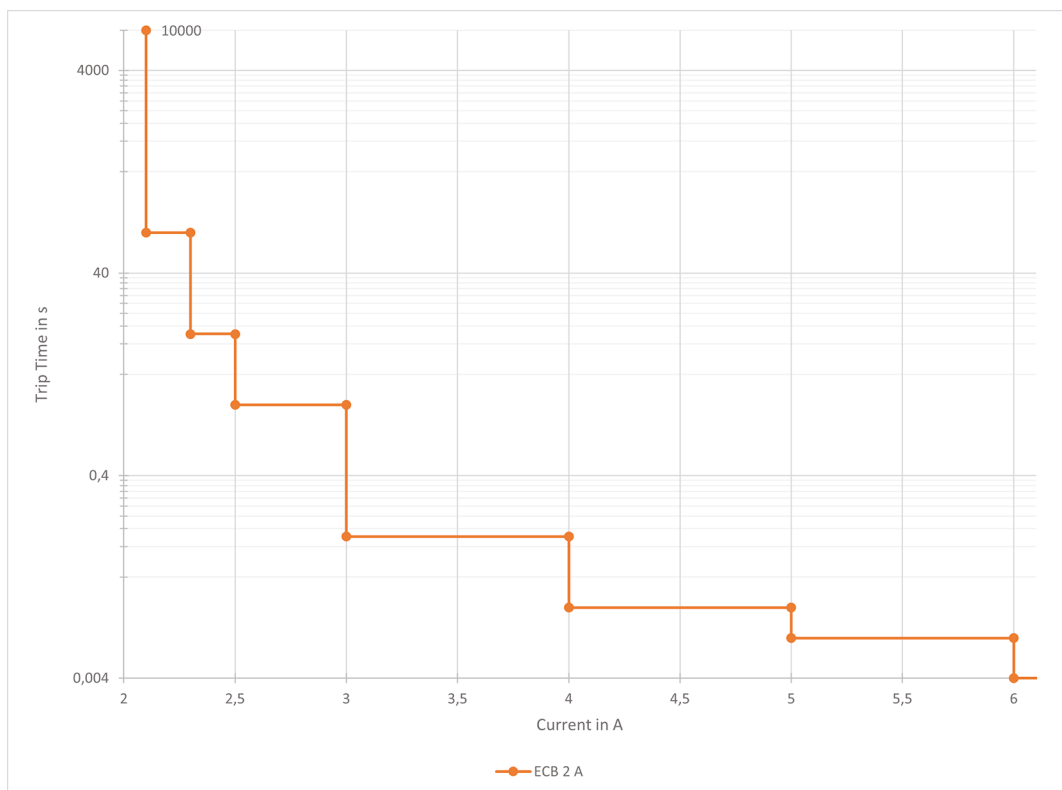

Figure 8: Trip Characteristic – 2 A

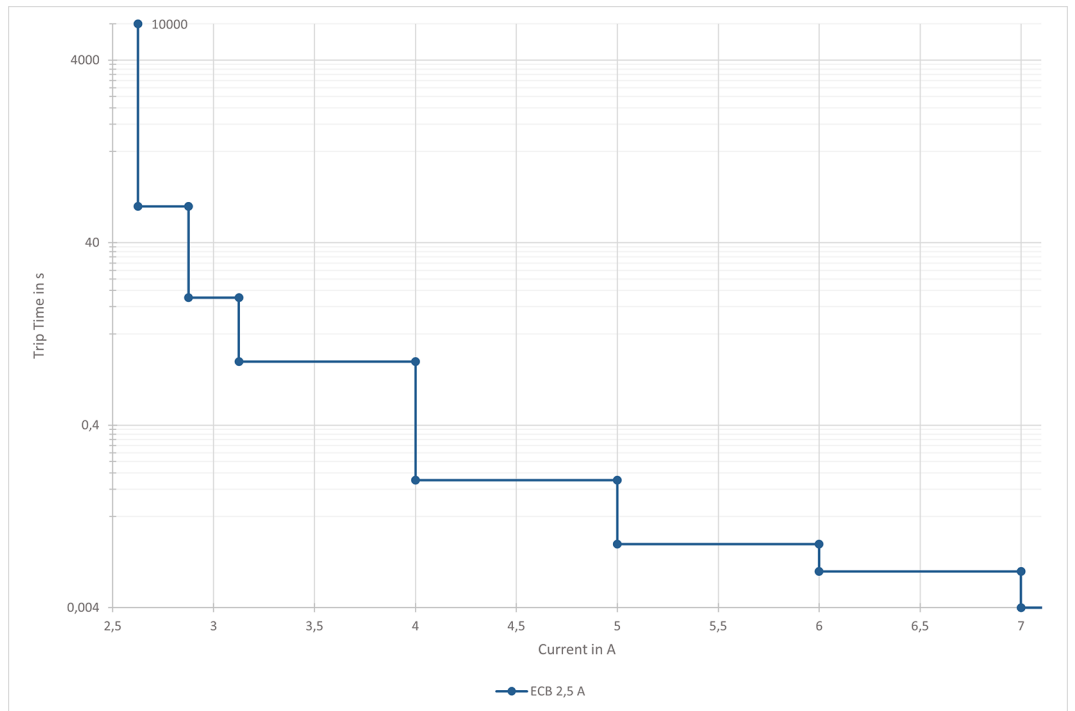

Figure 9: Trip Characteristic – 2.5 A

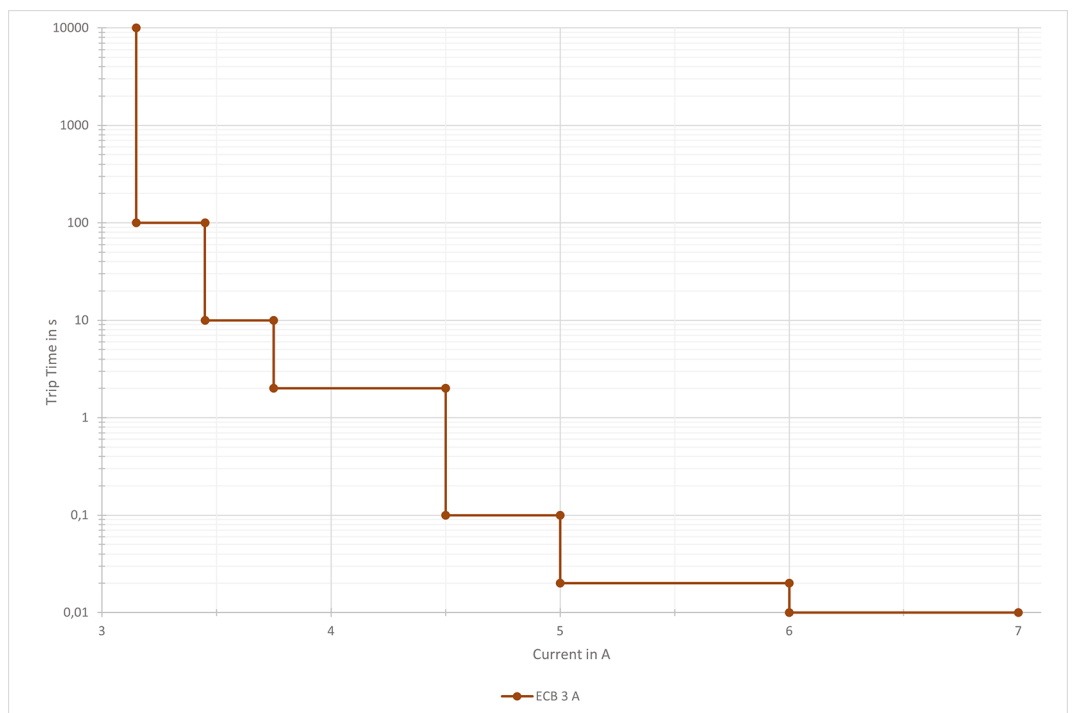

Figure 10: Trip Characteristic – 3 A

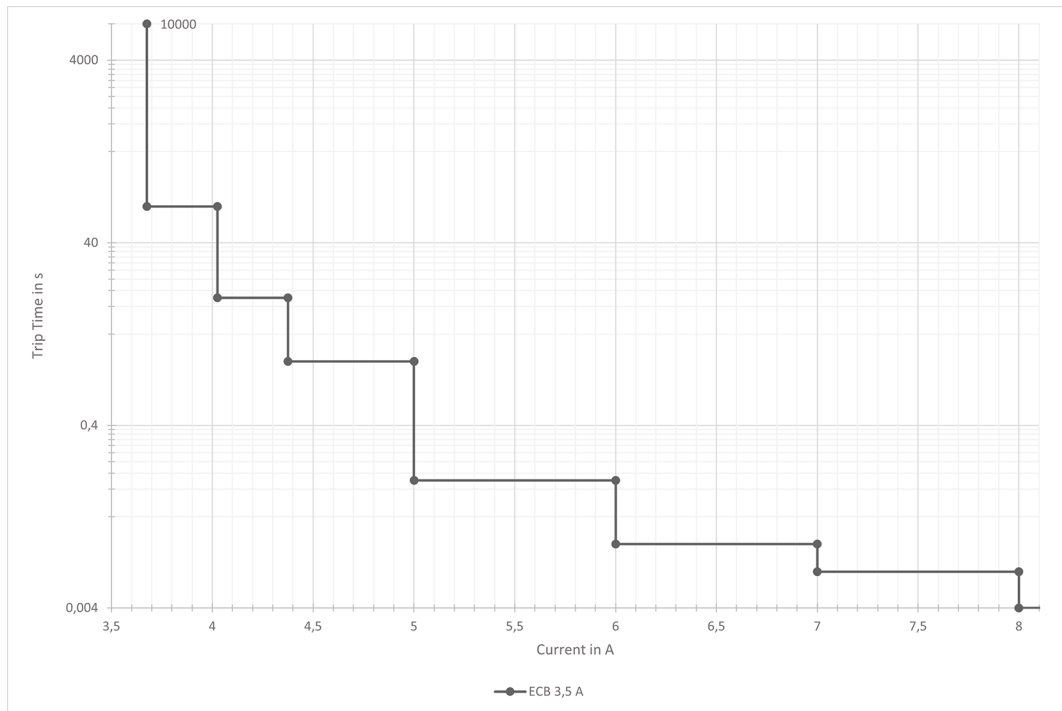

Figure 11: Trip Characteristic – 3.5 A

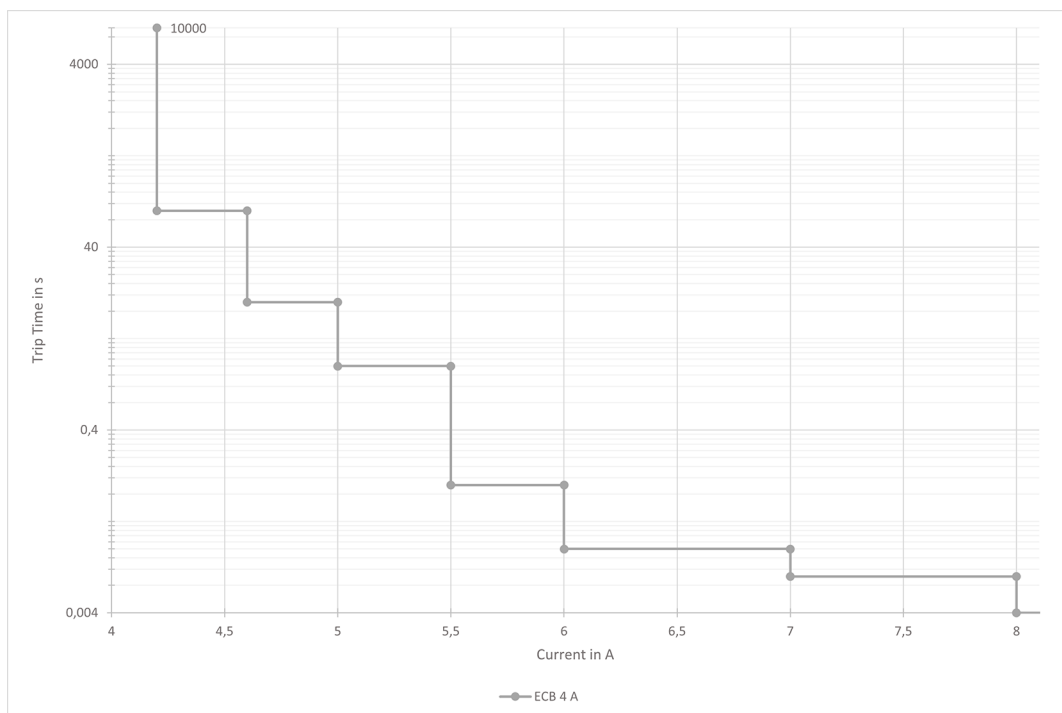

Figure 12: Trip Characteristic – 4 A

## 4.2 Conditions

Table 14: Channel Statuses

| State    | Channel      | LED State | Explanation                            |
|----------|--------------|-----------|--|
| Status 0 | Switched off | Off       | Product initialization (boot process)  |
| Status 1 | Switched on  | Green     | Load current < 90 % of nominal current |

| State     | Channel      | LED State                                    | Explanation  |
|-----------|--------------|--|--|
| Status 2  | Switched on  | Green, flashing (1 Hz)                       | Load current > 90 % of nominal current                           |
| Status 3  | Switched on  | Green, flashing (5 Hz)                       | Load current > 100 % of nominal current                          |
| Status 4  | Switched off | Red  | Channel switched off manually or through control input S1.       |
| Status 5  | Tripped      | Red, flashing (1 Hz)                         | Wait for temperature to return to normal.                        |
| Status 6  | Tripped      | Yellow, flashing (1 Hz)                      | Temperature returned to normal. Channel can be switched back on. |
| Status 7  | Switched off | Red  | Current dial to switch setting "L" and "C"                       |
| Status 8  | Tripped      | Red/yellow (1 Hz)                            | Undervoltage   |
| Status 9  | Tripped      | Red/yellow (5 Hz)                            | Overvoltage  |
| Status 10 | Tripped      | Red/yellow/green, one after the other (1 Hz) | Product error; wiring error; feedback voltage                    |

### 4.3 Undervoltage and Overvoltage Detection

The product only operates in a voltage range of 18 ... 30 VDC. Switching the channel on requires a minimum voltage of 20 VDC.

**Undervoltage detection:** If the voltage falls below 18 V during operation, the status LED flashes red/yellow at 1 Hz, and the channel trips to protect the downstream load. If the voltage returns to the nominal range (20 ... 30 VDC) within 60 seconds, the channel is switched back on, and the status LED lights up green.

If the voltage drops below 18 VDC for more than 60 seconds, the channel is not switched on after the voltage returns to the nominal range, and the status LED lights up red.

The product is protected against brief voltage dips that may occur in the supply network. For this purpose, a dead time of a few milliseconds is implemented, which ensures that the product does not trip inadvertently in such a situation.

**Overvoltage detection:** If the input voltage of the product rises above 30 VDC, the status LED flashes red/yellow at 5 Hz, and the channel trips to protect the downstream load. If the voltage returns to the nominal range, the channel is automatically switched back on, and the status LED lights up green.

The following table refers to the  **Conditions [▶ 22]** from the status table.

Table 15: Undervoltage and Overvoltage Detection

| Output Status | Product Behavior in the Event of |             | Product Behavior When Voltage Returns to Normal |  |
|---------------|----------------------------------|-------------|---|--|
|               | Undervoltage                     | Overvoltage | Undervoltage                                    | Overvoltage                                  |
| Status 1      | Status 8                         | Status 9    | Status 1, 2 or 3 (depending on load current)    | Status 1, 2 or 3 (depending on load current) |
| Status 2      | Status 8                         | Status 9    | Status 1, 2 or 3 (depending on load current)    | Status 1, 2 or 3 (depending on load current) |

| Output Status | Product Behavior in the Event of |             | Product Behavior When Voltage Returns to Normal |  |
|---------------|----------------------------------|-------------|---|--|
|               | Undervoltage                     | Overvoltage | Undervoltage                                    | Overvoltage                                  |
| Status 3      | Status 7                         | Status 9    | Status 7  | Status 1, 2 or 3 (depending on load current) |
| Status 4      | Status 8                         | Status 9    | Status 4  | Status 4                                     |
| Status 6      | Status 8                         | Status 9    | Status 6  | Status 6                                     |

#### 4.4 Capacitive Load

The product can be used to switch on high capacitive loads. The resulting high inrush currents put a strain on the power supply. The power supply must be able to deliver the maximum required power without the voltage falling below 20 VDC.

The capacity value to be reached depends on fundamental factors, such as the power supply already mentioned, the cable length and the conductor cross-section, as well as the properties of the load that is to be powered.

For some WAGO power supply units, possible load capacities have been determined empirically (see [🔗 Power Supplies \[▶ 39\]](#)).

#### **i** Note

##### Measures for capacitive loads without protection against reverse discharge

Faulty tripping of channels that are connected in parallel may occur on the supply side with capacitive loads that are not protected against reverse discharge.

- In this case, WAGO recommends taking suitable measures (e.g., a diode or MOS-FET) to decouple the capacitive load.

#### 4.5 On Delay

As soon as a minimum input voltage is present, the channel is activated with a time delay. This requires the channel to be switched on before the input voltage is switched off.

#### **i** Note

##### Note the behavior when the input voltage is restored!

The circuit breaker channel switches to the status it had before the input voltage was switched off. A channel that was manually switched off tripped is not automatically switched on.

The channel is randomly activated within 0 ... 500 ms with a time delay. If multiple electronic circuit breakers are connected to one power supply, this avoids larger current spikes at switch-on.



## 4.6 Control Input S1 and Signal Output S2

### Control Input S1

A signal (15 ... 30 V) between the control input and GND allows the status of the electronic circuit breaker to be changed. Which status is produced depends on the signal duration and previous status of the ECB.

Table 16: Control Input S1

| Signal                                  | Duration           | State  | Previous Status  |
|---|--------------------|--|--|
| <b>Signal 1:</b><br>Reset channel.      | 500 ms ... 1500 ms | <b>Status 1, 2 or 3 (depending on load current):</b><br>Channel switched on. | <b>Status 6 or 7:</b><br>Channel tripped.                                    |
| <b>Signal 2:</b><br>Switch channel on.  | 2000 ... 4000 ms   | <b>Status 1, 2 or 3 (depending on load current):</b><br>Channel switched on. | <b>Status 4:</b><br>Channel switched off.                                    |
| <b>Signal 3:</b><br>Switch channel off. | 5000 ... 7000 ms   | <b>Status 4:</b><br>Channel switched off.                                    | <b>Status 1, 2 or 2 (depending on load current):</b><br>Channel switched on. |

For more detailed information on individual signals and statuses, see the “General Operating Statuses” diagram in [🔗 Diagnostics via Indicators \[▶ 35\]](#).

### Signal Output S2

The channel status can be queried at the signal output. The signal output is short-circuit-proof and has a common potential with the power supply ground. The High signal output is not tripped.

The signal output can be configured in the default settings.

If the product has tripped, the signal output indicates this with a low signal (0 V). The signal outputs of up to 10 devices can be connected in parallel and serve as a common signal.

#### Note

#### Use signal output on a PLC!

When using the signal output on a PLC, connect the product's power supply ground to the PLC's ground!

Table 17: Signal output S2 – Signaling

| Channel      | State   | LED   | Signal Output S2 |                         |                       |                       |                       |                        |                                   |
|--------------|---|-------|------------------|-------------------------|-----------------------|-----------------------|-----------------------|------------------------|-----------------------------------|
|              |   |       | Tripped          | Current Flow Monitoring | Early Monitoring 90 % | Early Monitoring 80 % | Early Monitoring 70 % | External relay control | Tripped and Manually Switched Off |
| Switched off | <b>Status 0</b>                                   | Off   | 0 V              | 0 V                     | 0 V                   | 0 V                   | 0 V                   | 0 V                    | 0 V                               |
|              | <b>Status 4</b>                                   | Red   | 24 V             | 0 V                     | 24 V                  | 24 V                  | 24 V                  | 24 V                   | 0 V                               |
|              | <b>Status 7</b>                                   | Red   | 24 V             | 0 V                     | 24 V                  | 24 V                  | 24 V                  | 24 V                   | 0 V                               |
| Switched on  | <b>Status 1:</b><br>Load current < approx. 100 mA | Green | 24 V             | 0 V                     | 24 V                  | 24 V                  | 24 V                  | 0 V                    | 24 V                              |

| Channel | State   | LED  | Signal Output S2 |                         |                       |                       |                       |                        |                                   |
|---------|---|--|------------------|-------------------------|-----------------------|-----------------------|-----------------------|------------------------|-----------------------------------|
|         |   |  | Tripped          | Current Flow Monitoring | Early Monitoring 90 % | Early Monitoring 80 % | Early Monitoring 70 % | External relay control | Tripped and Manually Switched Off |
|         | <b>Status 1:</b><br>Load current > approx. 100 mA       | Green  | 24 V             | 24 V                    | 24 V                  | 24 V                  | 24 V                  | 0 V                    | 24 V                              |
|         | <b>Status 1:</b><br>Load current > 70 % nominal current | Green  | 24 V             | 24 V                    | 24 V                  | 24 V                  | 0 V                   | 0 V                    | 24 V                              |
|         | <b>Status 1:</b><br>Load current > 80 % nominal current | Green  | 24 V             | 24 V                    | 24 V                  | 0 V                   | 0 V                   | 0 V                    | 24 V                              |
|         | <b>Status 2</b>   | Green, flashing (1 Hz)                       | 24 V             | 24 V                    | 0 V                   | 0 V                   | 0 V                   | 0 V                    | 24 V                              |
|         | <b>Status 3</b>   | Green, flashing (5 Hz)                       | 24 V             | 0 V                     | 0 V                   | 0 V                   | 0 V                   | 0 V                    | 24 V                              |
| Tripped | <b>Status 5</b>   | Red, flashing (1 Hz)                         | 0 V              | 0 V                     | 0 V                   | 0 V                   | 0 V                   | 24 V                   | 0 V                               |
|         | <b>Status 6</b>   | Yellow, flashing (1 Hz)                      | 0 V              | 0 V                     | 0 V                   | 0 V                   | 0 V                   | 24 V                   | 0 V                               |
|         | <b>Status 8</b>   | Red/yellow (1 Hz)                            | 0 V              | 0 V                     | 0 V                   | 0 V                   | 0 V                   | 24 V                   | 0 V                               |
|         | <b>Status 9</b>   | Red/yellow (5 Hz)                            | 0 V              | 0 V                     | 0 V                   | 0 V                   | 0 V                   | 24 V                   | 0 V                               |
|         | <b>Status 10</b>  | Red/yellow/green, one after the other (1 Hz) | 0 V              | 0 V                     | 0 V                   | 0 V                   | 0 V                   | 0 V                    | 0 V                               |

### 4.7 Distributing and Multiplying a Potential

The product has two connection points for the positive output (connections 6 and 7) and two connection points for the negative input/output (connections 4 and 8).

Once the device is powered by a push-in type jumper bar, two load circuits can be connected directly to the device ( $V_{OUT+}/GND$ ). Additional terminal blocks can be omitted.

Observe the following note if you would like to common potentials with relays:

**! NOTICE****Connected relays: Only common equal potentials!**

Damage to the device may occur if different potentials are commoned!

If you use the relay with item no. 857-304, the potentials must only be commoned via connections  $V_{IN+}$  (connection 3) and GND (connection 8)!

You can find a connection example in [🔗 Connection Examples \[▶ 29\]](#).

**4.7.1 Commoning**

Push-in type jumper bars can be used to distribute an applied voltage or signal to multiple electronic circuit breakers.

- Commoning the power supply:  
The maximum supply current per connection point is 20 A. A current of 40 A can be distributed across multiple ECBs if the potential is fed in and commoned in parallel via two connection points.
- Commoning signal output S2:  
The signal outputs of up to 10 devices can be commoned and then serve as a common signal.

The respective products can be found as "related products" under [🌐 www.wago.com/787-3861/004-1020](http://www.wago.com/787-3861/004-1020).

**4.7.2 Potential Distribution Module**

WAGO's Power Distribution Modules (PDM) allow parallel connection with multiple lines to the fused supply voltage and GND potential by expanding product connections  $V_{out+}$  or GND ([🔗 Connections \[▶ 12\]](#)).

The housing contours and dimensions are based on the electronic circuit breakers. This allows the connection from PDM to push-in type jumper bars to be made directly; see also [🔗 Commoning \[▶ 27\]](#). The respective products can be found as "related products" under [🌐 www.wago.com/787-3861/004-1020](http://www.wago.com/787-3861/004-1020).

**4.8 Channel lock**

The current dial can be used to set the channel lock. This setting switches off the output of the product and the LED lights up red (see [🔗 Conditions \[▶ 22\]](#), "Status 7").

In this state, the output cannot be switched on manually with a button or via the control input.

# 5 Planning

## 5.1 Safety Measures at the Installation Location

### Additional Enclosure

The product is an open type device. It must only be installed within appropriate enclosures, cabinets or electrical operation rooms that fulfill at least the following requirements:

- Offer adequate protection against direct or indirect contact.
- Offer adequate protection against UV irradiation.
- Restrict access to authorized personnel and may only be opened with tools.
- Ensure the required pollution degree in the vicinity of the system.
- Prevent fire from spreading outside of the enclosure.
- Guarantee mechanical stability.

## 5.2 EMC Installation

### • Compliance with EMC interference emission standards







To comply with EMC interference standards, the cable length of the DC output must not exceed 30 m.

## 5.3 DIN-Rail Characteristics

- The material must have high corrosion resistance.
- The DIN-rail geometry must not be altered.
- Prevent bending and twisting (torsion) e.g., by using sufficient attachment points.
- Use countersink-head screws, blind rivets, etc., to countersink the attachment points beneath the node structure.
- The component DIN-rail contact (CuSn6) must not form a galvanic element with the DIN-rail that is capable of generating a differential voltage of more than 0.5 V (saline solution of 0.3% at 20°C/68°F).

WAGO DIN-rails meet the electrical and mechanical requirements.

Table 18: WAGO DIN-Rails

| Item No.  | Description   |
|---|---|
|  210-112 /  210-113 | 35 × 7.5; 1 mm steel, blue, chromated; slotted/unslotted  |
|  210-197 /  210-114 | 35 × 15; 1.5 mm steel, blue, chromated; slotted/unslotted |
|  210-118   | 35 × 15; 2.3 mm steel, blue; chromated; unslotted         |
|  210-198   | 35 × 15; 2.3 mm copper; unslotted                         |
|  210-196   | 35 × 8.2; 1.6 mm aluminum; unslotted                      |

## 5.4 Connection Examples

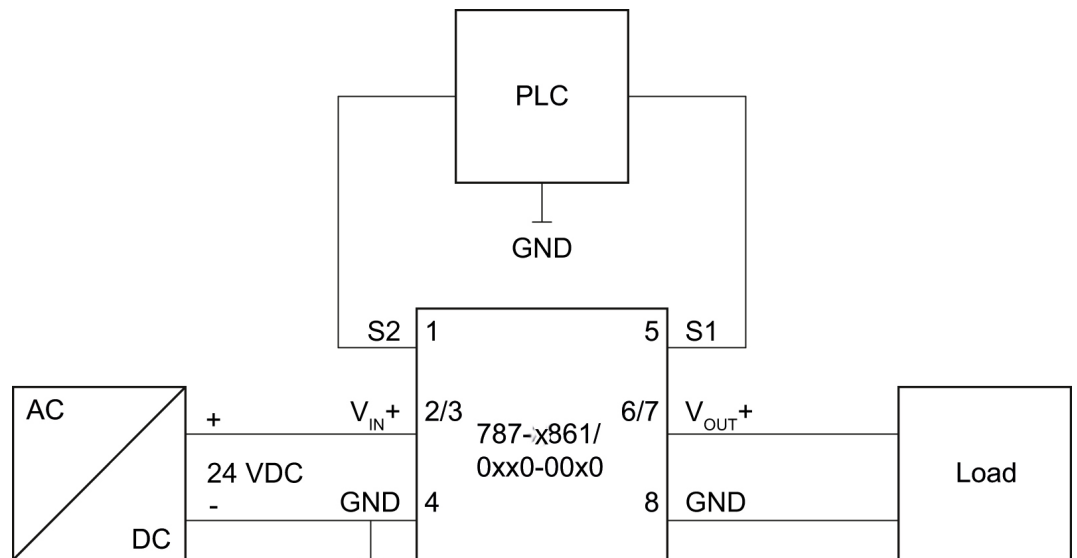

Figure 13: Connection Example

In the connection examples given below, additional relays are connected via signal output S2. To control a relay, signal output S2 must be set to the “External Relay Control” setting (see [🔗 Configuration via Button \[▶ 36\]](#)).

The resulting behavior of signal output S2 can be found in table “Signal Output S2 – Signaling,” column “External Relay Control” (see Signal Output S2).

WAGO offers the following relays for both variants (connection example: relay and all-pole fuse):

Table 19: Relay

| Item no. | Designation  |
|----------|--|
| 857-304  | Socket with miniature switching relay for DIN-35 rails |
| 788-304  | Socket with miniature switching relay for DIN-35 rails |

### Switching Off a Connected Load Circuit When Product Trips

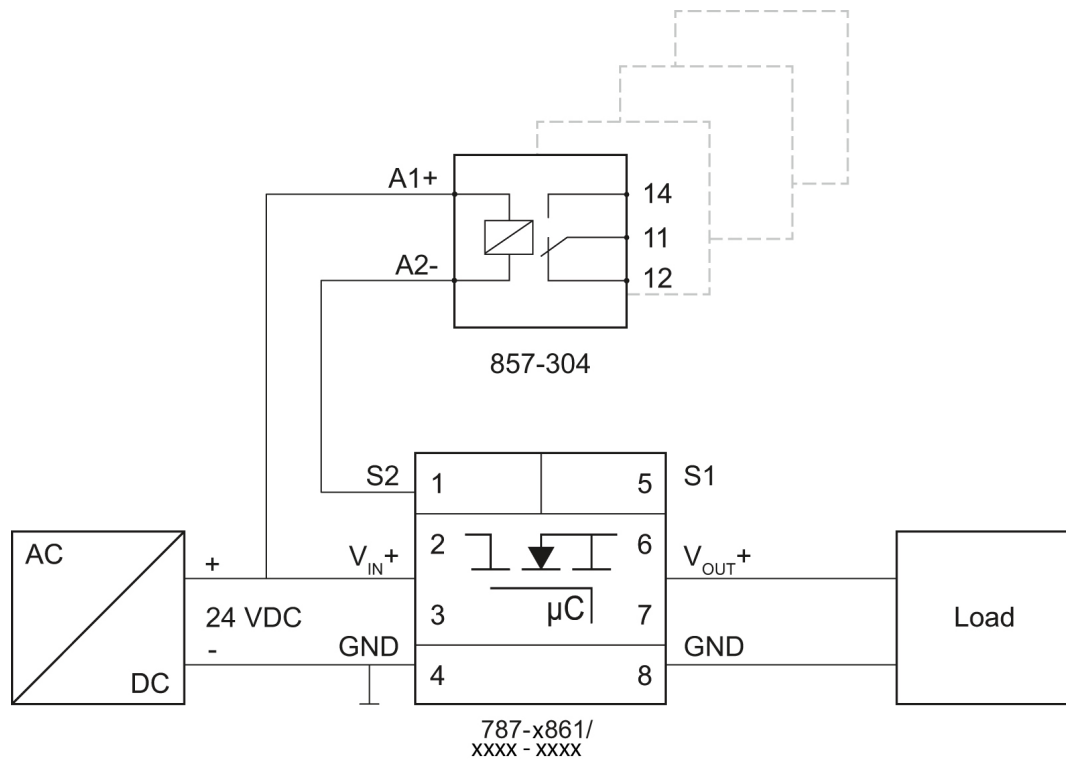

Figure 14: Connection Example: Relay Variant

In this variant, the relay also switches off additional load circuits when the product has tripped.

### Galvanic Isolation between Load Circuit and Input Potentials

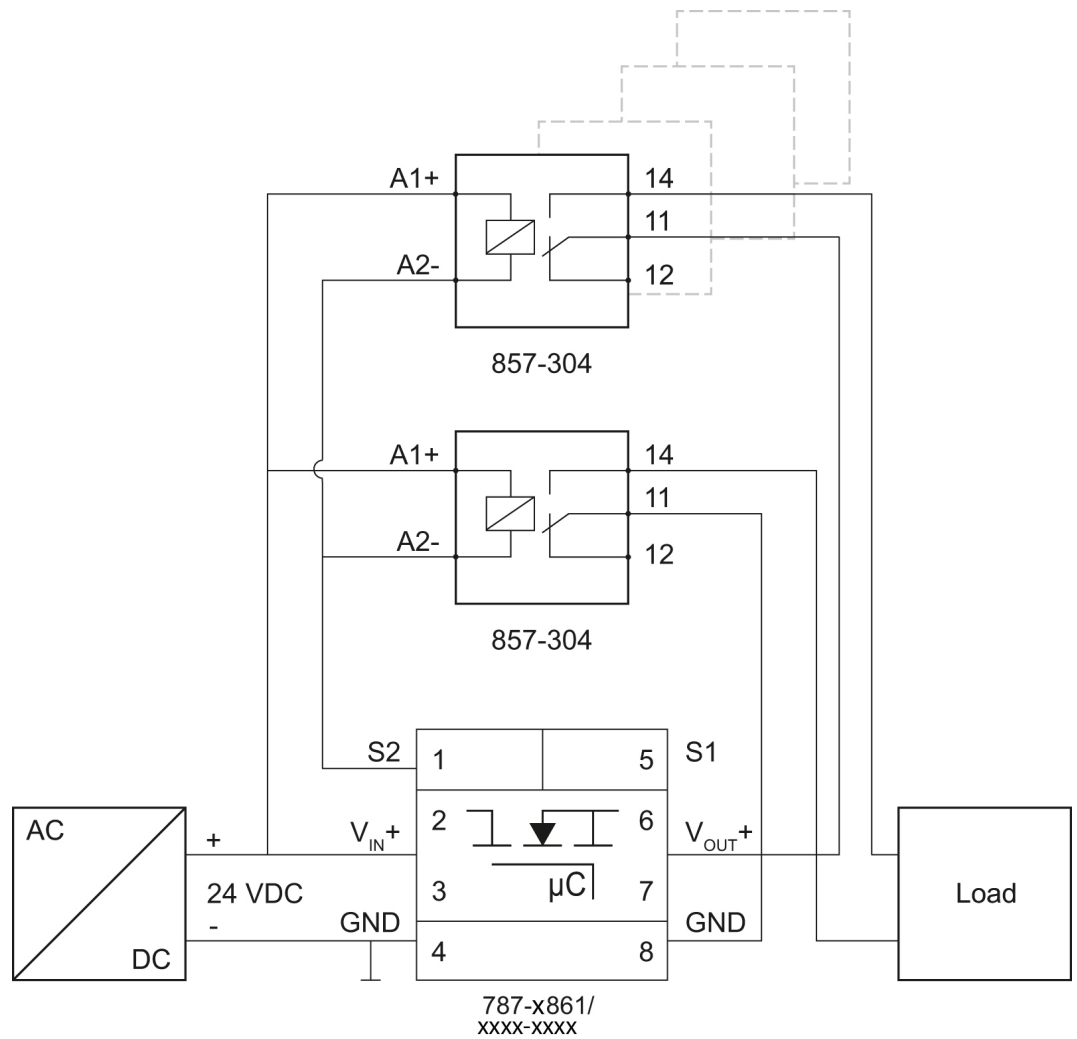

Figure 15: Connection Example: All-Pole Fuse Variant

In this variant, two relays ensure that the load circuit is electrically isolated from the input potentials if the product has tripped.

## 6 Transport and Storage

The original packaging offers optimal protection during transport and storage.

- Store the product in suitable packaging, preferably the original packaging.
- Only transport the product in suitable containers/packaging.
- Make sure the product contacts are not contaminated or damaged during packing or unpacking.
- Observe the specified ambient climatic conditions for transport and storage.



# 7 Installation and Removal

## ! NOTICE

### Avoid electrostatic discharge!

The products are equipped with electronic components that you may destroy by electrostatic discharge when you touch. Please observe the safety precautions against electrostatic discharge in accordance with EN 61340-5-1/-3. Pay attention while handling the products to good grounding of the environment (persons, job and packing).

## 7.1 DIN-35 Rail

The product is designed for mounting on a DIN-35 rail.

The DIN-rail is centered on the product depth (see [Product \[▶ 14\]](#)).

### Mounting on the DIN-Rail

Mount the product per EN 60715 by snapping it onto the DIN-rail without tools:

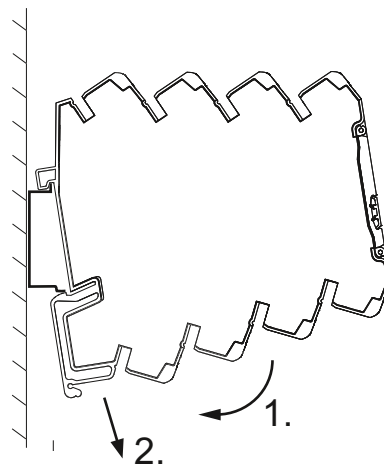
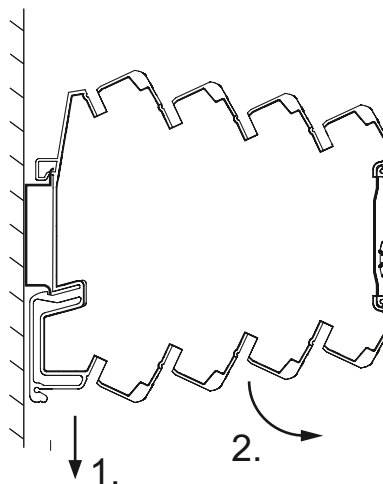

Figure 16: Assembly

1. Place the product, with the DIN-rail guide, on the top edge of the DIN-rail.
2. Press the product onto the DIN-rail [1] and simultaneously snap the product onto the snap-in mounting foot (c) [2].
3. To ensure secure mounting on the DIN-rail, install an end stop (e.g., Item No. **249-116**) in front of and behind the product (with a block arrangement: on either side of the products).

If products are snapped on alternately, place separator plates (Item No. **209-191**) between two adjacent clamping units for safe separation.

**Removal from the DIN-Rail***Figure 17: Disassembly*

1. To remove (see figure “Removal”), pull down the snap-in mounting foot (c) [1]. Use a screwdriver or an operating tool.
2. Tilt the product forward [2] and unhook it from the DIN-rail.

# 8 Diagnostics

## 8.1 Diagnostics via Indicators

Table 20: General Operating Statuses

| Operating Status   | LED State  | Level At Signal Output S2 <sup>1</sup> | Button Pushed | Signal at Control Input S1 |
|--|--|--|---------------|----------------------------|
| <b>Status 0:</b><br>Initialization of the product (boot process). <sup>2</sup>   | Off  | 0 V                                    |               |                            |
| <b>Status 1:</b><br>Channel switched on.   | Green  | 24 V                                   | Status 4      | Signal 3 →<br>Status 4     |
| <b>Status 2:</b><br>Channel switched on.<br>Load current > 90 % of nominal current   | Green, flashing<br>(1 Hz)                                | 24 V                                   | Status 4      | Signal 3 →<br>Status 4     |
| <b>Status 3:</b><br>Channel switched on.<br>Load current > 100 % nominal current <sup>3</sup>                                | Green, flashing<br>(5 Hz)                                | 24 V                                   | Status 4      | Signal 3 →<br>Status 4     |
| <b>Status 4:</b><br>Channel switched off manually or by control input S1. <sup>4</sup>                                       | Red  | 24 V                                   | Status 1      | Signal 2 →<br>Status 1     |
| <b>Status 5:</b><br>Channel tripped.<br>Wait for temperature to return to normal. <sup>5</sup>                               | Red, flashing<br>(1 Hz)                                  | 0 V                                    |               |                            |
| <b>Status 6:</b><br>Channel tripped.<br>Temperature has returned to normal.<br>Channel can be switched back on. <sup>6</sup> | Flashing yellow  | 0 V                                    | Status 4      | Signal 1 →<br>Status 1     |
| <b>Status 8:</b><br>Channel tripped.<br>Undervoltage   | Red/yellow,<br>flashing<br>(1 Hz)                        | 0 V                                    |               |                            |
| <b>Status 9:</b><br>Channel tripped.<br>Overvoltage  | Red/yellow,<br>flashing<br>(5 Hz)                        | 0 V                                    |               |                            |
| <b>Status 10:</b><br>Product error, wiring error, feedback voltage   | Red/yellow/<br>green<br>One after the<br>other<br>(1 Hz) | 0 V                                    |               |                            |

<sup>1</sup> This status may differ after configuration. More information can be found in table "Signal Output S2 – Signaling" (see [Control Input S1 and Signal Output S2 \[▶ 25\]](#)).

<sup>2</sup> The channel is switched back on with a time delay (0 ... 500 ms).

<sup>3</sup> The channel is automatically switched off according to the tripping characteristic given. The product then switches to status 5.

<sup>4</sup> The status is saved when the input voltage is switched off.

<sup>5</sup> After a waiting time (temperature returns to normal), the channel switches to status 6.

<sup>6</sup> The channel can be switched back on as follows:

- Pushing the button twice, or

- Applying a pulse (signal 1) to the control input (see [Control Input S1 and Signal Output S2 \[▶ 25\]](#)).

The product then switches to status 1.

# 9 Configuration

## 9.1 Configuration via Button

The button can be used to configure signal output S2:

1. Switch off the channel.
  - ⇒ The status LED lights up red.
2. Press and hold the button for at least 3 seconds.
  - ⇒ You are in configuration mode.
  - ⇒ The status LED lights up red and flashes green cyclically (according to the following table).
3. Press the button once.
  - The status LED lights up red and flashes green cyclically (according to the following table).
  - ⇒ You are in the next configuration status.
4. To save the selected configuration status, press and hold the button for at least 3 seconds.
  - The configuration status is saved.
  - The status LED lights up red

If the button is not pressed in configuration mode for > 30 seconds, the configuration is discarded, and the last saved configuration status is retained.

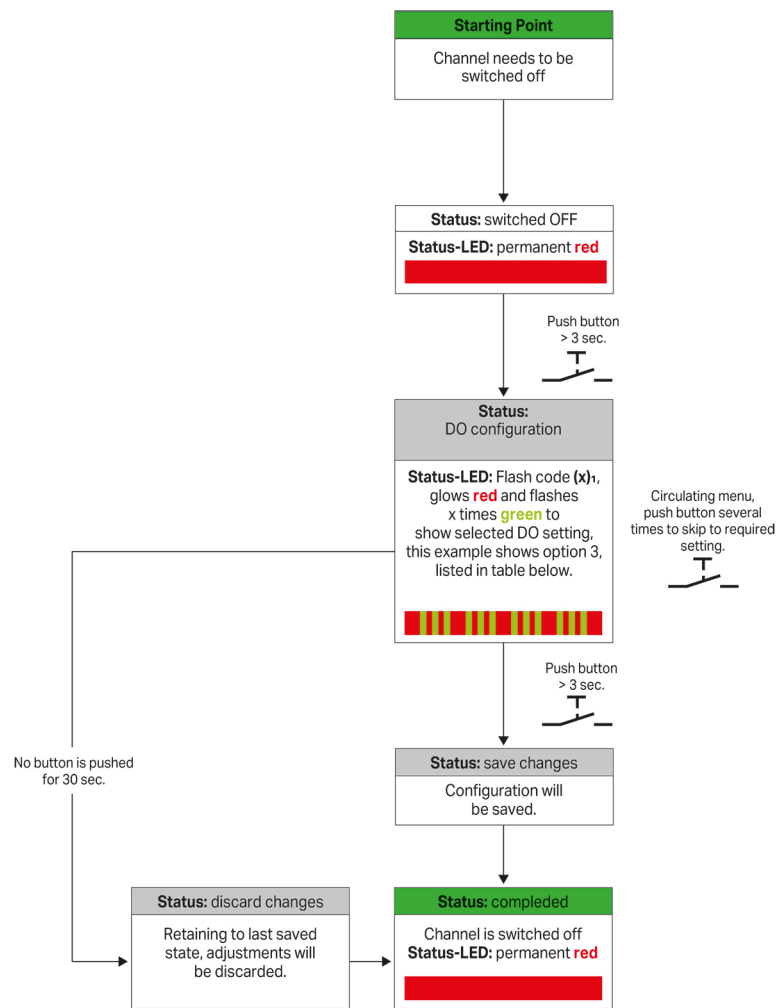

Figure 18: Configuration routine

Table 21: Flash Codes for Configuration via Button

| Flash Code (x) <sup>1)</sup> | Signal Output S2                 |
|------------------------------|----------------------------------|
| Status LED                   | Description                      |
| 1                            | Tripped                          |
| 2                            | Current flow monitoring          |
| 3                            | Early warning 90 %               |
| 4                            | Early warning 80 %               |
| 5                            | Early warning 70 %               |
| 6                            | Option: external relay control   |
| 7                            | Tripped or manually switched off |

<sup>1)</sup> The blink code is put out cyclically: x pulses (LED green), followed by a break time of 1.5 s. During the break time and between the pulses, the LED lights up red.

# 10 Decommissioning

## 10.1 Disposal and Recycling



### WEEE Mark

Electrical and electronic equipment may not be disposed of with household waste. This also applies to products without this mark.

Electrical and electronic equipment contain materials and substances that can be harmful to the environment and health. Electrical and electronic equipment must be disposed of properly after use. Environmentally friendly disposal benefits health, protects the environment from harmful substances in electrical and electronic equipment and enables sustainable and efficient use of resources.

- Observe the national and local regulations for the disposal of electrical and electronic equipment, lithium-ion batteries, lead–acid batteries and packaging.
- Clear any data stored on electrical and electronic equipment.
- Remove lithium-ion batteries, lead–acid batteries or memory cards that are added to the electrical and electronic equipment.
- Wear appropriate personal protective equipment when removing the lithium-ion batteries/lead–acid batteries.
- Dispose of the removed lithium-ion batteries/lead–acid batteries according to your local waste regulations (e. g. collection boxes at the retail or local collection points).
- Have electrical and electronic equipment sent to a local collection point.
- Dispose of all types of packaging to ensure a high level of recovery, reuse and recycling.
- Transport packages from the B2B area can be taken back free of charge via a return system in accordance with the Packaging Act. Please contact our service provider Interseroh directly. The corresponding certificate can be found at: [🌐 corporate-certificates](#)
- Throughout Europe, Directives 2006/66/EC, 94/62/EC and 2012/19/EU (WEEE) apply. National directives and laws may differ.

# 11 Appendix

## 11.1 Power Supplies

Table 22: Power Supplies

| Power Supply                                    |                 | 10 mF |         | 20 mF |         | 30 mF |         | 40 mF |         | 50 mF |         | Tested Base Load | Comment                                       |
|---|-----------------|-------|---------|-------|---------|-------|---------|-------|---------|-------|---------|------------------|---|
|   |                 | DC In | But-ton | DC In | But-ton | DC In | But-ton | DC In | But-ton | DC In | But-ton |                  |   |
| 2787-2144                                       | 5 A (Pro 2)     | √     | √       | √     | √       | √     | √       | √     | √       | √     | √       | 4.4 A            |   |
| 2787-2147                                       | 20 A (Pro 2)    | √     | √       | √     | √       | √     | √       | √     | √       | √     | √       | 4.4 A            |   |
| 2787-2448                                       | 40 A (Pro 2)    | √     | √       | √     | √       | √     | √       | √     | √       | √     | √       | 4.4 A            |   |
| 0787-1022                                       | 4 A (Classic)   | √     | √       | √     | √       | √     | √       | √     | √       | √     | √       | Approx. 1.2 A    |   |
| 0787-0722                                       | 5 A (Eco)       | √     | √       | √     | √       | √     | √       | √     | √       | √     | √       | 4.4 A            |   |
| 0787-1212                                       | 2.5 A (Classic) | O     | O       | X     | X       | X     | X       | X     | X       | X     | X       | Approx. 1.2 A    | 10 mF, partially loadable                     |
| 0787-0734                                       | 20 A (Eco)      | √     | √       | √     | √       | √     | √       | √     | √       | √     | √       | 4.4 A            | Old version of the power supply does not work |
| 0787-0736                                       | 40 A (Eco)      | X     | X       | X     | X       | X     | X       | X     | X       | X     | X       | 4.4 A            |   |
| 0787-0832                                       | 10 A (Pro)      | √     | √       | √     | √       | √     | √       | √     | √       | √     | √       | 4.4 A            |   |
| 0787-0834                                       | 20 A (Pro)      | √     | √       | √     | √       | √     | √       | √     | √       | √     | √       | 4.4 A            |   |
| 0787-0732                                       | 10 A (Eco)      | √     | √       | √     | √       | √     | √       | √     | √       | √     | √       | 4.4 A            |   |
| √: works  |                 |       |         |       |         |       |         |       |         |       |         |                  |   |
| O: works partially (depending on test patterns) |                 |       |         |       |         |       |         |       |         |       |         |                  |   |
| X: does not work                                |                 |       |         |       |         |       |         |       |         |       |         |                  |   |

### **i** Note

**For particularly powerful power supplies, especially with TopBoost and Power-Boost overload behavior, as well as buffering via any UPS modules (battery packs, etc.):**

The circuit breaker's integrated (device protection) fuse may trip in the event of a short circuit or when capacitive loads are charging due to the excessive overcurrent.

## 11.2 Protected Rights

- Adobe® and Acrobat® are registered trademarks of Adobe Systems Inc.
- Android™ is a trademark of Google LLC.
- Apple, the Apple logo, iPhone, iPad and iPod touch are registered trademarks of Apple Inc. registered in the USA and other countries. "App Store" is a service mark of Apple Inc.
- AS-Interface® is a registered trademark of the AS-International Association e.V.
- BACnet® is a registered trademark of the American Society of Heating, Refrigerating and Air Conditioning Engineers, Inc. (ASHRAE).
- Bluetooth® is a registered trademark of Bluetooth SIG, Inc.
- CiA® and CANopen® are registered trademarks of CAN in AUTOMATION – International Users and Manufacturers Group e.V.

- CODESYS is a registered trademark of CODESYS Development GmbH.
- DALI is a registered trademark of the Digital Illumination Interface Alliance (DiiA).
- Docker® and the Docker® logo are trademarks or registered trademarks of Docker, Inc. in the USA and/or other countries. Docker, Inc. and other parties may also have trademark rights to other terms used herein.
- EtherCAT® is a registered trademark and patented technology licensed by Beckhoff Automation GmbH, Germany.
- ETHERNET/IP™ is a registered trademark of the Open DeviceNet Vendor Association, Inc (ODVA).
- EnOcean® is a registered trademark of EnOcean GmbH.
- **flex**ROOM® is a registered trademark of WAGO Verwaltungsgesellschaft mbH.
- Google Play™ is a registered trademark of Google Inc.
- IO-Link is a registered trademark of PROFIBUS Nutzerorganisation e.V.
- KNX® is a registered trademark of the KNX Association cvba.
- Linux® is a registered trademark of Linus Torvalds.
- LON® is a registered trademark of the Echelon Corporation.
- Modbus® is a registered trademark of Schneider Electric, licensed for Modbus Organization, Inc.
- OPC UA is a registered trademark of the OPC Foundation.
- PROFIBUS® is a registered trademark of the PROFIBUS Nutzerorganisation e.V. (PNO).
- PROFINET® is a registered trademark of the PROFIBUS Nutzerorganisation e.V. (PNO).
- QR Code is a registered trademark of DENSO WAVE INCORPORATED.
- Subversion® is a trademark of the Apache Software Foundation.
- Windows® is a registered trademark of Microsoft Corporation.



# List of Tables

|          |   |    |
|----------|---|----|
| Table 1  | Definitions .....   | 8  |
| Table 2  | Basic Functions of the Button .....   | 13 |
| Table 3  | Technical Data – Product.....   | 14 |
| Table 4  | Technical Data – Input .....  | 14 |
| Table 5  | Technical Data – Control Input .....  | 14 |
| Table 6  | Technical Data – Output .....   | 14 |
| Table 7  | Technical Data – Signal Output .....  | 15 |
| Table 8  | Technical Data – Safety .....   | 15 |
| Table 9  | Technical Data – Connection Technology .....  | 15 |
| Table 10 | Technical Data – Environmental Conditions .....   | 16 |
| Table 11 | Technical Data – Mounting Positions and Ambient Temperatures in the Control Cabinet         | 16 |
| Table 12 | Technical Data – Horizontal Mounting Positions and Ambient Temperatures <sup>2)</sup> ..... | 16 |
| Table 13 | Standards and Regulations.....  | 16 |
| Table 14 | Channel Statuses.....   | 22 |
| Table 15 | Undervoltage and Overvoltage Detection .....  | 23 |
| Table 16 | Control Input S1 .....  | 25 |
| Table 17 | Signal output S2 – Signaling.....   | 25 |
| Table 18 | WAGO DIN-Rails .....  | 28 |
| Table 19 | Relay .....   | 29 |
| Table 20 | General Operating Statuses .....  | 35 |
| Table 21 | Flash Codes for Configuration via Button .....  | 37 |
| Table 22 | Power Supplies .....  | 39 |

# List of Figures

|           |  |    |
|-----------|--|----|
| Figure 1  | Example View .....                             | 11 |
| Figure 2  | <i>Connections (Example View)</i> .....        | 12 |
| Figure 3  | Indicators .....                               | 13 |
| Figure 4  | Trip Characteristic – Complete Overview .....  | 18 |
| Figure 5  | Trip Characteristic – 0.5 A .....              | 19 |
| Figure 6  | Trip Characteristic – 1 A .....                | 19 |
| Figure 7  | Trip Characteristic – 1.5 A .....              | 20 |
| Figure 8  | Trip Characteristic – 2 A .....                | 20 |
| Figure 9  | Trip Characteristic – 2.5 A .....              | 21 |
| Figure 10 | Trip Characteristic – 3 A .....                | 21 |
| Figure 11 | Trip Characteristic – 3.5 A .....              | 22 |
| Figure 12 | Trip Characteristic – 4 A .....                | 22 |
| Figure 13 | Connection Example.....                        | 29 |
| Figure 14 | Connection Example: Relay Variant.....         | 30 |
| Figure 15 | Connection Example: All-Pole Fuse Variant..... | 31 |
| Figure 16 | Assembly .....                                 | 33 |
| Figure 17 | Disassembly .....                              | 34 |
| Figure 18 | Configuration routine .....                    | 37 |



**WAGO GmbH & Co. KG**

Postfach 2880 · D - 32385 Minden  
Hansastraße 27 · D - 32423 Minden

✉ [info@wago.com](mailto:info@wago.com)  
🌐 [www.wago.com](http://www.wago.com)

|               |                          |
|---------------|--------------------------|
| Headquarters  | +49 571/887 – 0          |
| Sales         | +49 (0) 571/887 – 44 222 |
| Order Service | +49 (0) 571/887 – 44 333 |
| Fax           | +49 571/887 – 844169     |

## X-ON Electronics

Largest Supplier of Electrical and Electronic Components

*Click to view similar products for [Circuit Breakers](#) category:*

*Click to view products by [Wago](#) manufacturer:*

Other Similar products are found below :

[LUGZX66-1-61-20.0-44](#) [M39019/01-201](#) [M39019/01-221](#) [M39019/04-249S](#) [M39019/04-313S](#) [M55629/1-016](#) [M55629/1-018](#) [M55629/1-021](#)  
[M55629/1-033](#) [M55629/1-046](#) [M55629/1-048](#) [M55629/1-058](#) [M55629/1-067](#) [M55629/1-070](#) [M55629/1-079](#) [M55629/1-084](#) [M55629/1-085](#)  
[M55629/1-109](#) [M55629/11-102](#) [M55629/12-045](#) [M55629/12-046](#) [M55629/1-330](#) [M55629/1-366](#) [M55629/1-387](#) [M55629/1-401](#) [M55629/2-](#)  
[022](#) [M55629/2-030](#) [M55629/2-072](#) [M55629/2-082](#) [M55629/2-099](#) [M55629/2-101](#) [M55629/2-102](#) [M55629/21-BM-BM](#) [M55629/21-HM-HM](#)  
[M55629/21-NS-NS](#) [M55629/22-NR-NR-NR](#) [M55629/22-RS-RS-RS](#) [M55629/2-347](#) [M55629/2-401](#) [M55629/2-413](#) [M55629/3-030](#)  
[M55629/3-050](#) [M55629/3-102](#) [M55629/3-103](#) [M55629/3-128](#) [M55629/3-130](#) [M55629/3-238](#) [M55629/3-386](#) [M55629/3-LBZB](#) [M55629/4-](#)  
[115](#)