

WAGO Energy Meters (MID) with Push-in CAGE CLAMP® and Lever



879-3000 4PU



879-3040 2PU CT



879-3020 4PS

Operating Instructions

Version: 082022V1.6

Table of Contents

1 Safety information	3
2 Introduction	5
3 Certificates	6
3.1 MID Declaration of Conformity: 4PU and 4PS	6
3.2 CE Declaration of Conformity: 4PU und 4PS	7
3.3 MID Declaration of Conformity: 2PU CT	8
3.4 CE-Declaration of Conformity: 2PU CT	9
4 Specifications	10
4.1 Performance Criteria	10
4.2 Measurement Deviations	11
4.3 Software Version Checksum	11
4.4 Bluetooth® Specifications	11
4.5 M-Bus Communication Specifications	11
4.6 Modbus®/RS485 Communication Specifications	11
4.7 Enclosure Dimensions	12
4.8 Connection Technology	12
4.9 Connection Diagram	13
4.9.1 Connection Diagram 879-3000 (4PU)	13
4.9.2 Connection Diagram 879-3020 (4PS)	14
4.9.3 Connection Diagram 879-3040 (2PU CT)	15
5 Installation	16
6 Operation	17
6.1 Display Part 1 (MID-relevant)	17
6.2 Display Part 2 (MID-relevant)	17
6.3 Display Part 3 (non-MID-relevant)	17
6.4 Process Diagram 4PU/4PS & 2PU CT	18
6.5 Settings	19
6.6 Bluetooth®	19
6.7 Settings via Buttons	20
6.7.1 Password	20
6.7.2 Tariff	20
6.7.3 S0 Pulse Output	21
6.7.4 Pulse Type Setting	21
6.7.5 S0 Pulse Length	21
6.7.6 Modbus® ID	22
6.7.7 Modbus®-Baudrate	22
6.7.8 Modbus® Parity	22
6.7.9 M-Bus-ID	22
6.7.10 M-Bus Baud Rate	23
6.7.11 Backlight	23
6.7.12 Power-down Counter	23
6.7.13 Trip Counter	23
6.7.14 OBIS Codes	24
6.8 OBIS-Codes - Tables	24
6.9 Set Transformer Ratio (2PU CT only)	26
7 Troubleshooting	28
7.1 Error / Diagnostic Indication	28
7.2 Technical Support	28
Appendix 1 – Multi-Tariff Function	29
A1.1 Switching Tariffs between T1 and T2	29
A1.2 Switching Tariffs to T3 and T4	29
Appendix 2 – M-Bus	30
A2.1 Communication via the M-Bus Interface	30
A2.2 M-Bus Register Map	31
A2.3 M-Bus Write Register	32
Appendix 3 – Modbus®	33
A3.1 Communication via the Modbus® Interface	33
A3.2 Modbus® Register Map	34
A3.3 Modbus® Write Register	38

1 Safety information

Information on your own safety

This manual does not contain all of the safety measures for operating this meter, as particular operating conditions, local codes or ordinances may require additional measures. However, it contains information that must be observed for your personal safety and to avoid damage to property. This information highlighted by a warning triangle with an exclamation mark or a lightning bolt, depending on the degree of actual or potential hazard:



Warning

This means that failure to heed the notice could result in death, serious injury or significant property damage.



Caution

This means there is a risk of electric shock and failure to heed the notice will result in death, serious injury or significant property damage.

Qualified Personnel

The installation and operation of the device described in this manual must only be carried out by qualified personnel. Only qualified electricians according to EN 50110-1/-2 and IEC 60364 are qualified personnel in the sense of this manual.

Intended Use

This device may only be used for the applications specified in the catalog and in the user manual and only in connection with devices and components recommended and approved by WAGO. The device is an open system. Install the device in lockable enclosures, cabinets or electrical operation rooms only. Access must be limited to authorized, qualified staff having the appropriate key or tool.

Proper Handling

Requirements for the trouble-free, safe operation of the product are proper transport, storage, installation and connection as well as careful operation and maintenance. During operation, certain parts of the meter can carry dangerous voltages.

- During assembly, startup, operation, maintenance and troubleshooting, adhere to the specific accident prevention provisions applicable to your machine/system, such as DGUV Regulation 3 "Electrical installations and equipment".
- To minimize any hazardous situations resulting in personal injury or to avoid failures in your system, the data and power supply lines shall be installed according to standards, with careful attention given to ensuring the correct terminal assignment.
- Always adhere to the EMC directives applicable to your application.
- The meter is intended for installation in an "M1" mechanical environment, with minor shocks and vibrations and an "E2" electromagnetic environment, according to Directive 2014/32/EC. The meter is intended for indoor use. The meter must be installed in a suitable IP-rated enclosure, in accordance with local regulations. The devices have been developed for use in an environment that meets the criterion of the IP20 protection type. There is protection against finger injury and protection against the ingress of solid foreign objects greater than or equal to 12.5 mm, but no protection against water. Unless otherwise specified, operation of the devices in wet and dusty environments is prohibited.

- Ensure that the conductors used are suitable for the maximum current of this meter and the prevailing environmental conditions.
- Make sure all leads are properly connected before applying power to the meter.
- Make sure that protection against accidental contact is in place after installing the energy meter. If this cannot be guaranteed on site for operational reasons and bare conductors can be seen, attachment of the terminal cover is required.
- For each individual application, the devices are supplied from the factory with a dedicated hardware and software configuration. These modules contain no parts that can be serviced or repaired by the user.
The following actions will result in the exclusion of liability on the part of WAGO GmbH & Co. KG:
 - Repairs
 - Changes to the hardware or software that are not described in the operating instructions
 - Improper use of the component.
 Further details are given in the contractual agreements.
Please send your suggestions for modifications to modified or new hardware or software configurations directly to WAGO GmbH & Co. KG.
- Never break any seals (if provided on this meter) to open the front cover as this will affect the functionality or accuracy of the meter and will void any warranty.
- Do not drop the meter or subject it to physical shock as it contains high-precision components. The components could break and negatively affect the measurement.
- Only use conductor cross-sections approved for the terminal blocks with appropriately stripped ends.

Exclusion of Liability



We have reviewed the contents of this manual and have made every effort to ensure that the descriptions are as accurate as possible. Nevertheless, deviations from the description cannot be completely ruled out, so that no liability can be accepted for any errors or omissions in the information. The information in this manual is reviewed regularly and any necessary corrections incorporated into subsequent editions. Should you have any suggestions, please do not hesitate to contact us.

2 Introduction

Although we produce the energy meters according to international standards and our quality control is very strict, it is still possible that this meter has a defect or failure, for which we apologize. Under normal conditions, your product should provide you with years of trouble-free service. If there is a problem with the energy meter, you should contact your dealer immediately. The enclosures of the energy meters are sealed and must not be opened. Opening the enclosure or damaging the seal will void the warranty.

3 Certificates



3.1 MID Declaration of Conformity: 4PU and 4PS

	<h3>EU-type examination certificate</h3> <p>Number T12050 revision 6 Project number 3545379 Page 1 of 1</p>
Issued by	NMi Certin B.V., designated and notified by the Netherlands to perform tasks with respect to conformity modules mentioned in article 17 of Directive 2014/32/EU, after having established that the Measuring instrument meets the applicable requirements of Directive 2014/32/EU, to:
Manufacturer	Inepro Metering BV Pondweg 7 2153 PK Nieuw Vennepe The Netherlands
Measuring instrument	A static Active Electrical Energy Meter Type : 4PS, 4PU Manufacturer's mark or name : Inepro Reference voltage : 230V; 3x230/400 V Reference current : 5 A Destined for the measurement of : electrical energy, in a - three-phase four-wire network - three-phase three-wire network - two-phase three-wire network - single-phase two-wire network Accuracy class : A or B Environment classes : M1 / E2 Temperature range : -40 °C / +70 °C
Valid until	22 February 2031
Remark	This revision replaces the earlier versions, including its documentation folder.
Issuing Authority	NMi Certin B.V., Notified Body number 0122 26 July 2022
	Certification Board
NMi Certin B.V. Thijssseweg 11 2629 JA Delft The Netherlands T +31 88 636 2332 certin@nmi.nl www.nmi.nl	This document is issued under the provision that no liability is accepted and that the manufacturer shall indemnify third-party liability. The designation of NMi Certin B.V. as Notified Body can be verified at http://ec.europa.eu/growth/tools-databases/nando/
	Reproduction of the complete document only is permitted. This document is digitally signed and sealed. The digital signature can be verified in the blue ribbon at the top of the electronic version of this certificate.
	

3.2 CE Declaration of Conformity: 4PU und 4PS

	<p>We,</p> <p style="text-align: center;">Inepro Metering BV</p> <p>(supplier's name)</p> <hr/>						
	<p>Pondweg 7 2153 PK Nieuw-Vennep The Netherlands</p> <p>(supplier's address)</p> <hr/>						
	<p>declare under our sole responsibility that the product:</p> <p>4PU and 4PS</p> <p>Three phase DIN rail Watt Hour meter</p> <p>(Name, type or model, batch or serial number, possibly source and number of items)</p> <hr/>						
	<p>to which this declaration relates in conformity with the following European harmonized and published standards at date of this declaration:</p> <p style="text-align: center;">EN 50470-1:2006 EN 50470-3:2006</p> <p>(Title and or number and date of issue of the applied standard(s))</p> <hr/>						
<p>This declaration of Conformity is suitable to the European Standard EN 45014 <i>General Criteria for Supplier's Declaration of Conformity</i>. The basis for the criteria has been found in international documentation, particularly in ISO / IEC, Guide 22, 1982, <i>Information on manufacturer's Declaration of Conformity with standards or other technical specifications</i></p>	<p>Following the provisions of the Directives (if applicable):</p> <table><tr><td><input checked="" type="checkbox"/></td><td>2014/32/EU (MID)</td></tr><tr><td><input checked="" type="checkbox"/></td><td>2011/65/EU (RoHS)</td></tr><tr><td><input checked="" type="checkbox"/></td><td>1907/2006 (REACH)</td></tr></table> <hr/>	<input checked="" type="checkbox"/>	2014/32/EU (MID)	<input checked="" type="checkbox"/>	2011/65/EU (RoHS)	<input checked="" type="checkbox"/>	1907/2006 (REACH)
	<input checked="" type="checkbox"/>	2014/32/EU (MID)					
<input checked="" type="checkbox"/>	2011/65/EU (RoHS)						
<input checked="" type="checkbox"/>	1907/2006 (REACH)						
	<p>Nieuw-Vennep, 23-02-2021</p> <p>Place and date of issue</p> <hr/>						
	<p>D. van der Vaart</p> <p>Name of responsible for CE-marking</p> <hr/>						

3.3 MID Declaration of Conformity: 2PU CT

	<h2>EU-type examination certificate</h2> <p>Number T12229 revision 4 Project number 3499794 Page 1 of 1</p>
Issued by	NMi Certin B.V., designated and notified by the Netherlands to perform tasks with respect to conformity modules mentioned in article 17 of Directive 2014/32/EU, after having established that the Measuring instrument meets the applicable requirements of Directive 2014/32/EU, to:
Manufacturer	Inepro Metering BV Pondweg 7 2153 PK Nieuw Vennep The Netherlands
Measuring instrument	A static Active Electrical Energy Meter Type : 2PU CT Manufacturer's mark or name : Inepro Reference voltage : 230V; 3x230/400 V Reference current : 1 A Destined for the measurement of : electrical energy, in a - three-phase four-wire network - three-phase three-wire network - two-phase three-wire network - single-phase two-wire network Accuracy class : A or B Environment classes : M1 / E2 Temperature range : -40 °C / +70 °C
Valid until	15 October 2031
Remark	This revision replaces previous revisions, except for its documentation folder.
Issuing Authority	NMi Certin B.V., Notified Body number 0122 18 March 2022
	Certification Board
	<p>This document is issued under the provision that no liability is accepted and that the manufacturer shall indemnify third-party liability.</p> <p>The designation of NMI Certin B.V. as Notified Body can be verified at http://ec.europa.eu/growth/tools-databases/nando/</p>
	<p>Reproduction of the complete document only is permitted.</p> <p>This document is digitally signed and sealed. The digital signature can be verified in the blue ribbon at the top of the electronic version of this certificate.</p> 

3.4 CE-Declaration of Conformity: 2PU CT



We,

Inepro Metering BV
Pondweg 7
2153 PK Nieuw-Vennep
The Netherlands



Declare under our sole responsibility that the product;
2PU CT

Static Active Electrical Energy Meter with the measurement range of;

Three phase DIN rail Watt Hour meter

To which this declaration relates in conformity with the following European harmonized and published standards at date of this declaration

EN 50470-1-2006

EN 50470-3-2006

EN IEC 61326-1:2021

ETSI EN 301 489-1: V2.2.3 (2019-11)

ETSI EN 301 489-17: V3.2.4 (2020-09)

ETSI EN 300 328: V2.2.2 (2019-07)

EN 62311:2020

Following the provisions of the Directives (If applicable)

2014/32/EU (MID)

2011/65/EU (RoHS)

1907/2006 (REACH)

2014/53/EU (RED)

Nieuw-Vennep, 08-03-2021

Name of responsible for CE-Marking

D. van der Vaart

This declaration of Conformity is suitable to the European Standard EN 45014 *General Criteria for Supplier's Declaration of Conformity*. The basis for the criteria has been found in international documentation, particularly in

ISO / IEC, Guide 22, 1982, *Information on manufacturer's Declaration of Conformity with standards or other technical specifications*

4 Spezifikationen

Material	Polycarbonate (PC 940A)						
Nominal voltage (U _n)	AC 230 / 400 V (3~)						
Operating voltage	3 x 230 / 400 V ±20 %						
Insulation capacity:							
- AC voltage resistance	4 kV für 1 Minute						
- Pulse volate resistance	6 kV ... 1,2µS waveform						
	<table border="1" style="margin-left: auto; margin-right: auto;"> <thead> <tr> <th style="text-align: center;">4PU und 4PS</th> <th style="text-align: center;">2PU CT</th> </tr> </thead> <tbody> <tr> <td style="text-align: center;">5 A</td> <td style="text-align: center;">1 A</td> </tr> <tr> <td style="text-align: center;">65 A</td> <td style="text-align: center;">5 A</td> </tr> </tbody> </table>	4PU und 4PS	2PU CT	5 A	1 A	65 A	5 A
4PU und 4PS	2PU CT						
5 A	1 A						
65 A	5 A						
Base current (I _b)							
Maximum nominal current (I _{max})	0,4%I _b ... I _{max}						
Operating current range	30 I _{max} für 0,01s						
Overcurrent resistance	45 ... 60Hz						
Operating frequency	≤2 W/Phase - ≤10 VA/Phase (active - reactive)						
Internal consumption	10.000 imp/kWh						
Pulse output red LED on the front	10.000 (2PU CT)/2.000/1.000 (4PU und 4PS)/100/10/1/0,1/0,01						
50 pulse output rate (imp/kWh)	(default = bold)						
Pulse width	Selectable 2 ... 99 ms (depending on pulse output rate)						
Memory	The data is stored for up to 10 years, even without a power supply.						

4.1 Performance Criteria

Humidity during operation	≤ 75 %
Humidity during storage	≤ 95 %
International storage	EN50470-1/3
Accuracy class	B (=1 % accuracy)
Protection against	
Dust and water	IP51 (front side); IP20 (connection)
Protection class	II
Ambient temperature (operation)	-40 ... +70°C

Item/ Product	Conductor cross-section/ Conductor cross-section	Rated current/ Rated current	Ambient temperature/ Ambient temperature		
			40 °C	55 °C	70 °C
879-3000 879-3020	25 mm ² (fine-stranded conductor)	65 A		X	
		45 A			X
	16 mm ² (fine-stranded conductor with insulated ferrule)	65 A	X		
		55 A		X	
		35 A			X
	16 mm ² (fine-stranded conductor)	65 A	X		
		50 A		X	
		35 A			X
	10 mm ² (fine-stranded conductor with insulated ferrule)	55 A	X		
		45 A		X	
		30 A			X
	10 mm ² (feindrähtige Leiter/fine-stranded conductor)	55 A	X		
		40 A		X	
		30 A			X
	6 mm ² (fine-stranded conductor with insulated ferrule)	41 A	X		
		39 A		X	
		27 A			X
	6 mm ² (fine-stranded conductor)	41 A	X		
		37 A		X	
		25 A			X
4 mm ² (fine-stranded conductor with insulated ferrule)	32 A	X			
	27 A		X		
	17 A			X	
4 mm ² (fine-stranded conductor)	30 A	X			
	25 A		X		
	15 A			X	

4.2 Measurement Deviations

0,05 I _b	Cosφ = 1	±1,5%
0,1 I _b	Cosφ = 0,5L	±1,5%
	Cosφ = 0,8C	±1,5%
0,1 I _b ... I _{max}	Cosφ = 1	±1,0%
0,2 I _b ... I _{max}	Cosφ = 0,5L	±1,0%
	Cosφ = 0,8C	±1,0%

4.3 Software Version Checksum

The checksum is used to control the meter's software. You can use the checksum to check whether the software is fully functional or whether it contains errors.

For 4PU/4PS:

Software Version	Checksum
V1.18	27325923
V1.21	27327238
V1.26	59269903
V1.28	59268366
V1.34	59268366

For 2PU CT:

Software Version	Checksum
V1.02	59629173
V1.03	59607739
V1.04	59811839

If you have found a discrepancy in the checksum, contact technical support immediately at tel. +49 (0) 571/887 - 44555 or by email at support@wago.com.

4.4 Bluetooth® Specifications

Protocol	BLE 4.2
Frequency range	Bluetooth® 4.0: 2402 ... 2480 MHz (40 CH)

4.5 M-Bus Communication Specifications

Bus type	2-wire (M-Bus)
Baud rate	300, 600, 1200, 2400 (standard) , 4800 and 9600
Parity	Even (even; unchangeable, fixed by default)
Range	≤1000m
Downlink signal	Master to slave. Voltage Modulation
Uplink signal	Slave to master. Current Modulation
Cable (recommended)	JYSTY (nx2x0.8)
Protocol	EN13757-3
Unit loads/standard load	1
Max. number of bus subscribers	64 per bus*

4.6 Modbus®/RS485 Communication Specifications

Bus type	RS-485
Protocol	Modbus RTU with 16-bit CRC
Baud rate	1200, 2400, 4800, 9600 (standard) , 19200, 38400, 57600 and 115200
Parity	Even/ none (standard) /odd
Address range	1-247 adjustable
Maximum bus load	60 meters per bus*
Range	≤1000 m

- Note that the maximum number of meters depends on the converter, the baud rate (the higher the baud rate, the smaller the number of meters that can be used) and the circumstances under which the meters are installed.

4.7 Enclosure Dimensions

4PU / 4PS

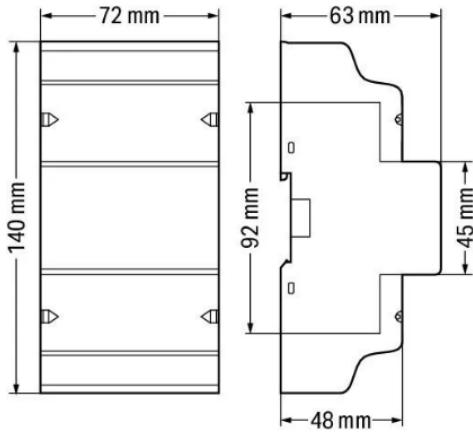

Height without cover
Height with cover
Width
Depth
Weight

4PU / 4PS	2PU CT
92 mm	97 mm
140 mm	140 mm
72 mm	36 mm
63 mm	63 mm
0.34 kg (net)	0.2 kg (net)

2PU CT

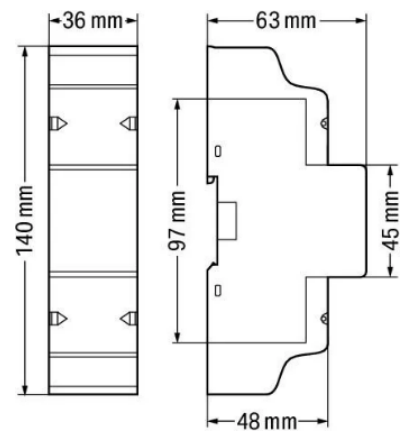

4.8 Connection Technology

Clamp technology
Actuation type

Push-in CAGE CLAMP®
Lever

WAGO 2616 Series

Solid conductors
Fine-stranded conductors
Fine-stranded conductors with ferrule and plastic collar

0.75 ... 16 mm² / 18 ... 4 AWG
0.75 ... 25 mm² / 18 ... 4 AWG
0.75 ... 16 mm²

WAGO 2604 Series

Solid conductors
Fine-stranded conductors
Fine-stranded conductors with ferrule and plastic collar

0.2 ... 4 mm² / 24 ... 12 AWG
0.2 ... 4 mm² / 24 ... 12 AWG
0.25 ... 2.5 mm²

Push-in technology can be used for solid conductors, fine-stranded conductors and fine-stranded conductors with ferrules. In the case of fine-stranded conductors, the levers must be opened for connection.

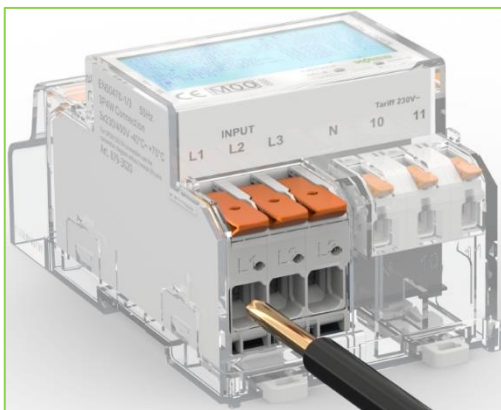

Circuit diagram: Solid conductors

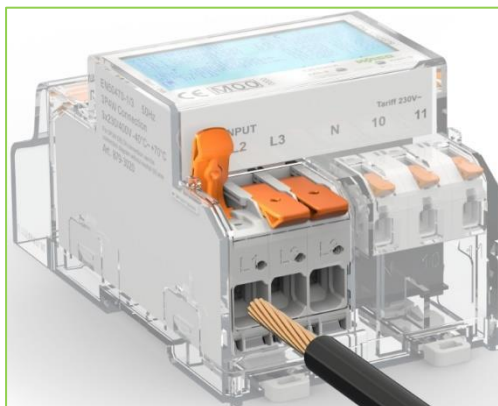

Circuit diagram: Fine-stranded conductors

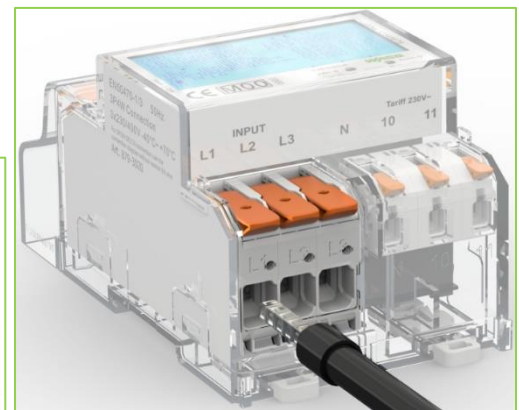

Circuit diagram: Fine-stranded conductors with ferrule

4.9 Connection Diagram

4.9.1 Connection Diagram 879-3000 (4PU)

<p>4PU – 3P4W</p>	<p>IN L1: Input Phase L1 – OUT L1: Output Phase L1 IN L2: Input Phase L2 – OUT L2: Output Phase L2 IN L3: Input Phase L3 – OUT L3: Output Phase L3 N: Neutral conductor 4: S0 output 1 (+) 5: Ground for S0 (-) 6: S0 output 2 (+) 7: Modbus® (A) 8: Ground for Modbus® (B) / M-Bus (-) 9: M-Bus (+) 10, 11: Tariff (230 VAC)</p>
<p>4PU – 3P3W Open Delta (Aron; for IT networks only!)</p> <p>Please put a bridge between N and U2 - IN!</p>	<p>IN L1: Input Phase L1 – OUT L1: Output Phase L1 IN L2: Input Phase L2 – OUT L2: Output Phase L2 IN L3: Input Phase L3 – OUT L3: Output Phase L3 N: External bridge on terminal point IN L2 4: S0 output 1 (+) 5: Ground for S0 (-) 6: S0 output 2 (+) 7: Modbus® (A) 8: Ground for Modbus (B) / M-Bus (-) 9: M-Bus (+) 10, 11: Tariff (230 VAC)</p>
<p>4PU – 3P3W Delta</p>	<p>IN L1: Input Phase L1 – OUT L1: Output Phase L1 IN L2: Input Phase L2 – OUT L2: Output Phase L2 IN L3: Input Phase L3 – OUT L3: Output Phase L3 N: Not used 4: S0 output 1 (+) 5: Ground for S0 (-) 6: S0 output 2 (+) 7: Modbus® (A) 8: Ground for Modbus® (B) / M-Bus (-) 9: M-Bus (+) 10, 11: Tariff (230 VAC)</p>
<p>4PU – 1P2W 1-phasig</p>	<p>IN L1: Input Phase L1 – OUT L1: Output Phase L1 IN L2: not used – OUT L2: not used IN L3: not used – OUT L3: not used N: Neutral conductor 4: S0 output 1 (+) 5: Ground for S0 (-) 6: S0 output 2 (+) 7: Modbus® (A) 8: Ground for Modbus® (B) / M-Bus (-) 9: M-Bus (+) 10, 11: Tariff (230 VAC)</p>

4.9.2 Connection Diagram 879-3020 (4PS)

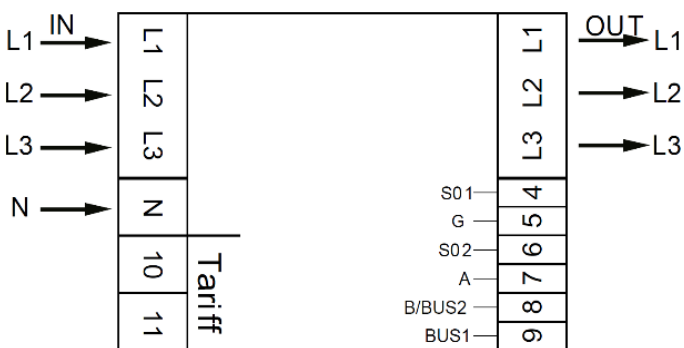
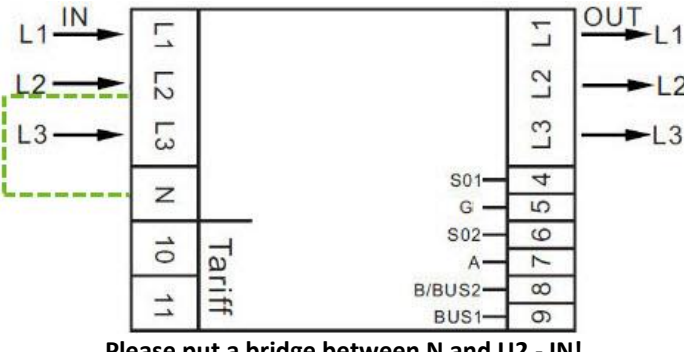
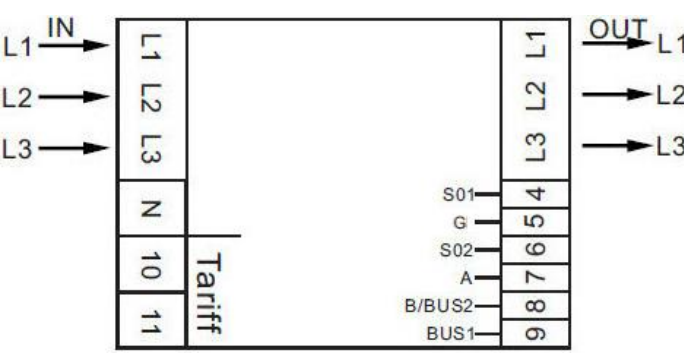
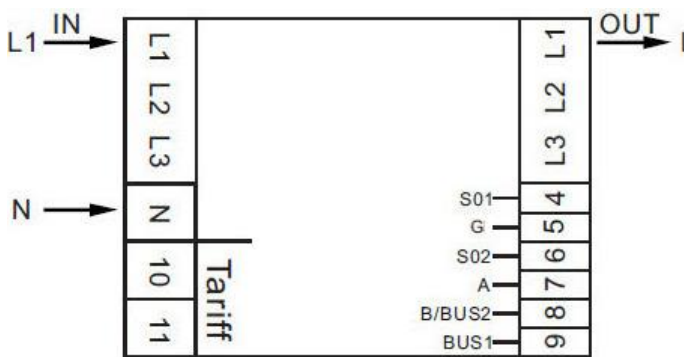
<p>4PS – 3P4W</p> 	<p>IN L1: Input Phase L1 – OUT L1: Output Phase L1 IN L2: Input Phase L2 – OUT L2: Output Phase L2 IN L3: Input Phase L3 – OUT L3: Output Phase L3 N: Neutral conductor 4: S0 output 1 (+) 5: Ground for S0 (-) 6: S0 output 2 (+) 7: Modbus® (A) 8: Ground for Modbus® (B) / M-Bus (-) 9: M-Bus (+) 10, 11: Tariff (230 VAC)</p>
<p>4PS – 3P3W Open Delta (Aron; for IT networks only!)</p>  <p>Please put a bridge between N and U2 - IN!</p>	<p>IN L1: Input Phase L1 – OUT L1: Output Phase L1 IN L2: Input Phase L2 – OUT L2: Output Phase L2 IN L3: Input Phase L3 – OUT L3: Output Phase L3 N: External bridge on terminal point IN L2 4: S0 output 1 (+) 5: Ground for S0 (-) 6: S0 output 2 (+) 7: Modbus® (A) 8: Ground for Modbus® (B)/M-Bus (-) 9: M-Bus (+) 10, 11: Tariff (230 VAC)</p>
<p>4PS – 3P3W Delta</p> 	<p>IN L1: Input Phase L1 – OUT L1: Output Phase L1 IN L2: Input Phase L2 – OUT L2: Output Phase L2 IN L3: Input Phase L3 – OUT L3: Output Phase L3 N: Not used 4: S0 output 1 (+) 5: Ground for S0 (-) 6: S0 output 2 (+) 7: Modbus® (A) 8: Ground for Modbus® (B)/M-Bus (-) 9: M-Bus (+) 10, 11: Tariff (230 VAC)</p>
<p>4PS – 1P2W 1-phasig</p> 	<p>IN L1: Input Phase L1 – OUT L1: Output Phase L1 IN L2: not used – OUT L2: not used IN L3: not used – OUT L3: not used N: Neutral conductor 4: S0 output 1 (+) 5: Ground for S0 (-) 6: S0 output 2 (+) 7: Modbus® (A) 8: Ground for Modbus® (B) / M-Bus (-) 9: M-Bus (+) 10, 11: Tariff (230 VAC)</p>

4.9.3 Connection Diagram 879-3040 (2PU CT)

<p>2PU CT – 3P4W</p>	<p>IN CT1: Input CT1 – OUT CT1: Output CT1 IN CT2: Input CT2 – OUT CT2: Output CT2 IN CT3: Input CT3 – OUT CT3: Output CT3 U1 ; U2 ; U3: Voltage L1 ; L2 ; L3 N: Neutral conductor 4: S0 output 1 (+) 5: Ground for S0 (-) 6: S0 output 2 (+) 7: Modbus® (A) 8: Ground for Modbus® (B) / M-Bus (-) 9: M-Bus (+) 10, 11: Tariff (230 VAC)</p>
<p>2PU CT – 3P3W Open Delta (Aron; for IT networks only!)</p> <p>Please put a bridge between N and U2 - IN!</p>	<p>IN CT1: Input CT1 - OUT CT1: Output CT1 IN CT2: not used - OUT CT2: not used IN CT3: Input CT3 - OUT CT3: Output CT3 U1 ; U2 ; U3: Voltage L1 ; L2 ; L3 N: External bridge on terminal block IN U2 4: S0 output 1 (+) 5: Ground for S0 (-) 6: S0 output 2 (+) 7: Modbus® (A) 8: Ground for Modbus® (B) / M-Bus (-) 9: M-Bus (+) 10, 11: Tariff (230 VAC)</p>
<p>2PU CT – 3P3W Delta</p>	<p>IN CT1: Input CT1 – OUT CT1: Output CT1 IN CT2: Input CT2 – OUT CT2: Output CT2 IN CT3: Input CT3 – OUT CT3: Output CT3 U1 ; U2 ; U3: Voltage L1 ; L2 ; L3 N: Not used 4: S0 output 1 (+) 5: Ground for S0 (-) 6: S0 output 2 (+) 7: Modbus® (A) 8: Ground for Modbus® (B) / M-Bus (-) 9: M-Bus (+) 10, 11: Tariff (230 VAC)</p>
<p>2PU CT – 1P2W 1-phasig</p>	<p>IN CT1: Input CT1 – OUT CT1: Output CT1 IN CT2: not used – OUT CT2: not used IN CT3: not used – OUT CT3: not used U1 ; U2 ; U3: Voltage L1 ; L2 ; L3 N: Neutral conductor 4: S0 output 1 (+) 5: Ground for S0 (-) 6: S0 output 2 (+) 7: Modbus® (A) 8: Ground for Modbus® (B) / M-Bus (-) 9: M-Bus (+) 10, 11: Tariff (230 VAC)</p>

5 Installation

- Switch off all supply sources of the energy meter and the devices connected to it and secure them against being switched on again before working on the system.



- Check the voltage with a meter to ensure the system is de-energized.

- Installation must only be carried out by qualified personnel who are familiar with the applicable rules and regulations.



- Use insulated tools to install the device.

- A fuse, thermal isolator or single pole circuit breaker should be placed on the supply line and not on the neutral line.

- The connection cable connecting the equipment to the external circuit should be rated for the maximum current of the fuse or other overcurrent protection device used in the circuit in accordance with local regulations.

- An external fuse or circuit breaker should be installed on the supply lines to isolate the meter and power supply devices. It is recommended to place this fuse or circuit breaker near the meter as it is more convenient for the operator. Both the fuse and circuit breaker must meet the specifications of the building's electrical design and all local codes.

- An external fuse or thermal shutdown used as an overcurrent protection device for the meter must be installed on the supply-side wiring. It is recommended to place this protection also near the meter to facilitate the work of the operator. The circuit breaker must conform to the specifications of the building's electrical design and all local codes.

- To prevent tampering, an enclosure may be protected with a lock or similar device. Furthermore, the cover caps of the terminal points can be sealed using seals.

- The meter must be installed on a fireproof wall.

- The meter must be installed in a well-ventilated and dry place.

- The meter must be installed in a protective box if the meter is exposed to dust or other contaminants.

- The meter has been developed for mounting on DIN rails in accordance with EN 60715.

- If the meter is installed in an area with frequent overvoltages, e.g., due to thunderstorms, welding machines, inverters, etc., the meter must be protected by a surge protection device.

- The device should be sealed immediately after installation to prevent tampering.

6 Operation

6.1 Display Part 1 (MID-relevant)

Part 1 of the display shows the MID-relevant values such as software version number, meter serial number, CRC code, current tariff and unit of the MID-relevant measurement units (kWh). The meter serial number and CRC code are displayed alternately every 10 seconds. If *Bluetooth* communication is enabled, the *Bluetooth* icon is displayed. If Modbus or M-Bus communication is enabled, square brackets are displayed.

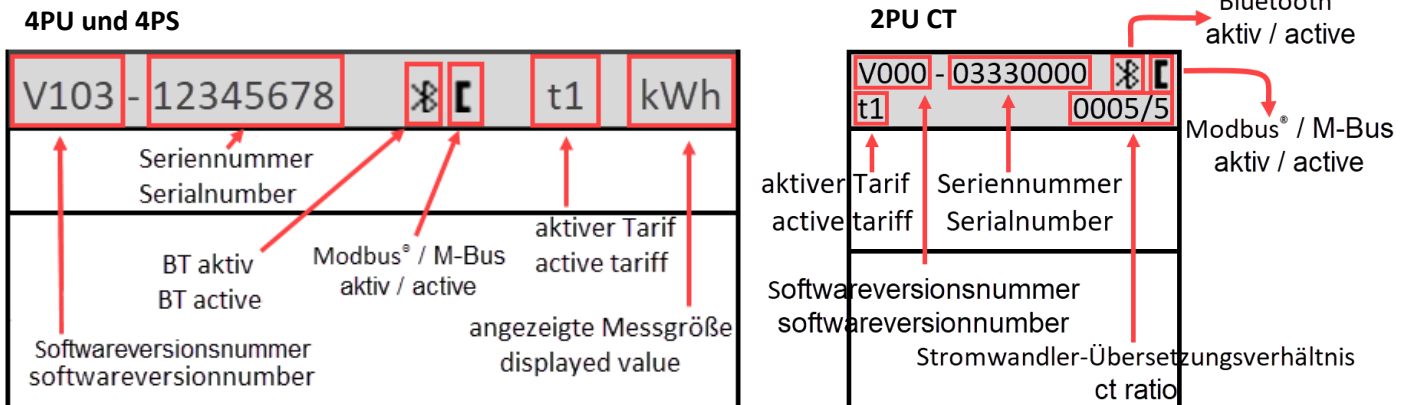

6.2 Display Part 2 (MID-relevant)

Part 2 of the display shows the MID-relevant measured values. The OBIS codes are used to identify the corresponding measured values:
Forward direction:

- 1.8.1: Positive Active Energy in Tariff 1
- 1.8.2: Positive Active Energy in Tariff 2
- 1.8.3: Positive Active Energy in Tariff 3
- 1.8.4: Positive Active Energy in Tariff 4

Reverse direction:

- 2.8.1: Negative Active Energy in Tariff 1
- 2.8.2: Negative Active Energy in Tariff 2
- 2.8.3: Negative Active Energy in Tariff 3
- 2.8.4: Negative Active Energy in Tariff 4

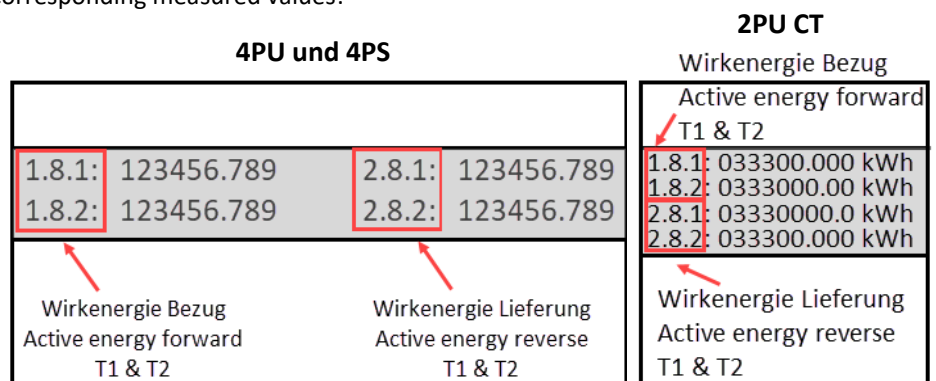

The tariff values are displayed alternately so that T1 and T2 are displayed together, T3 and T4 together.

The meter has a 6+3-digit kWh display. When it reaches 999999.999, this value goes back to 000000.000.

6.3 Display Part 3 (non-MID-relevant)

Part 3 of the display shows the non-MID-relevant data such as current direction, day counter, reactive energy, power factor, current quadrant, frequency, active power, apparent power, reactive power, voltage and current.

The display pages can be changed using the capacitive touch keys on the front of the measuring device. (Total - L1 - L2 - L3). Furthermore, the OBIS codes and units change as soon as the meter detects a different current flow direction or when the meter changes to a different quadrant. A list of all OBIS codes can be found on page 24.

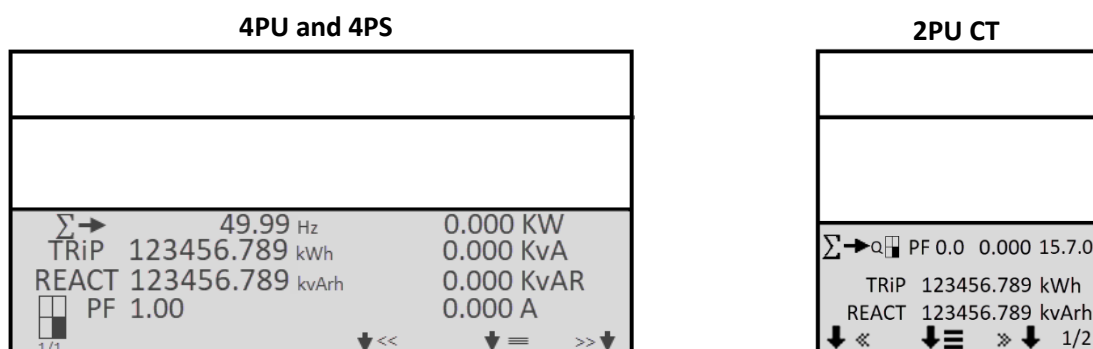

6.4 Process Diagram 4PU/4PS & 2PU CT

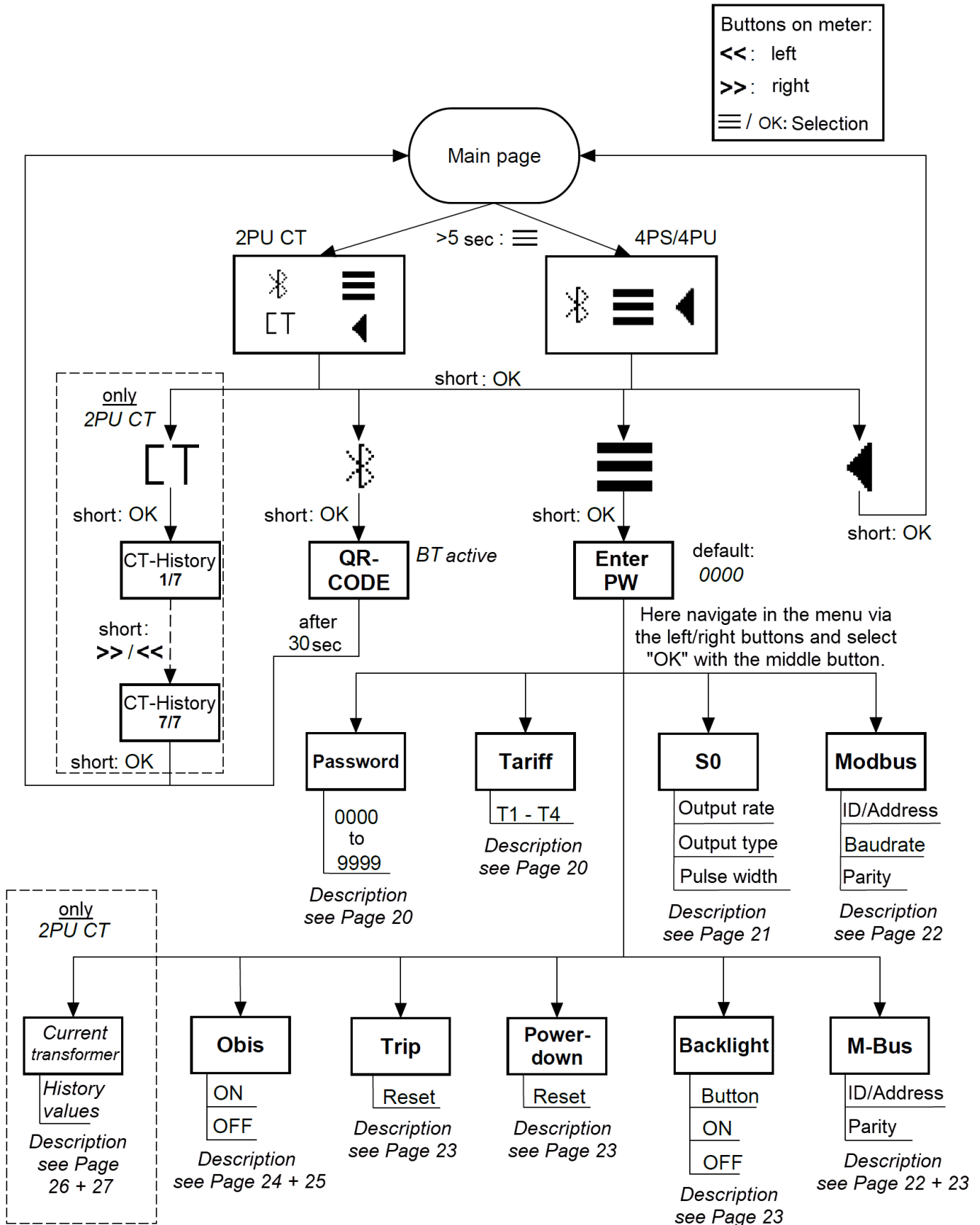

6.5 Settings

There are three buttons on the front of the meters, marked with a green line. To enter settings mode, press and hold the center button for > 3 seconds.

4PU and 4PS

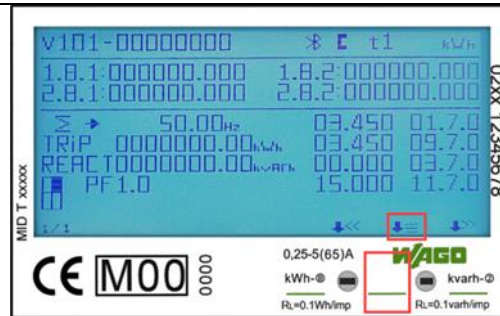

2PU CT

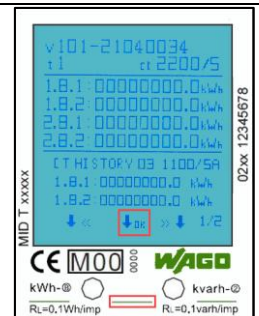

The following is displayed:

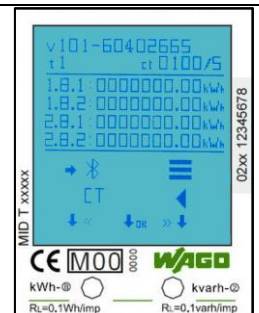
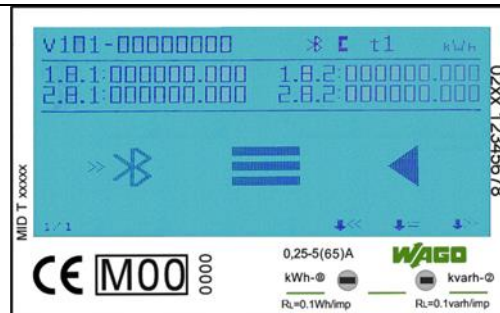

6.6 Bluetooth®

If the arrows >> point to the *Bluetooth*® icon, press the middle button:

4PU and 4PS

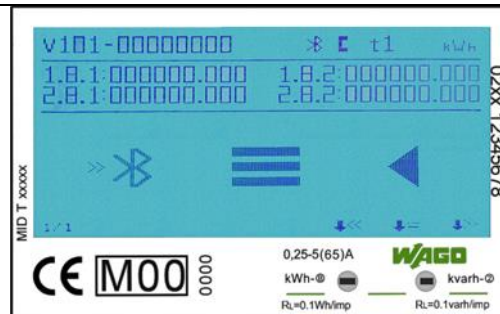

2PU CT

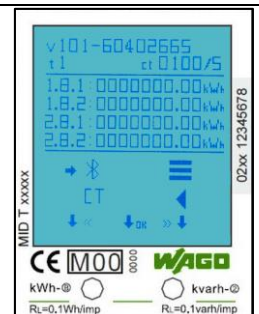

The *Bluetooth*® interface of the meter is now enabled and ready for communication with the WAGO Energy Meter Configurator app. To connect to the meter, scan the QR code with the app or browse the *Bluetooth*® environment by selecting the appropriate menu item in the app.

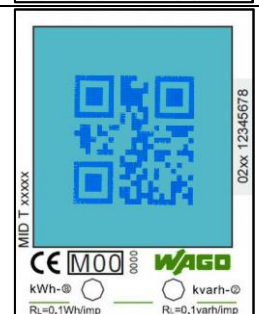
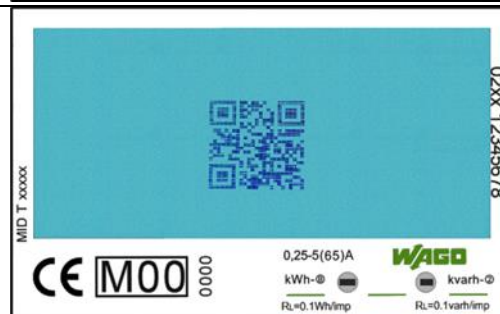

If a *Bluetooth*® connection is established, the *Bluetooth*® icon is shown on the display: (Description of the WAGO app in Appendix 4 – *Bluetooth*®)

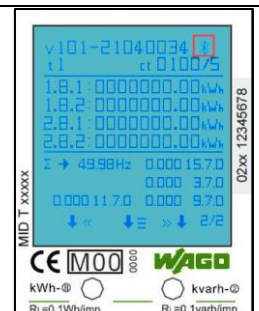
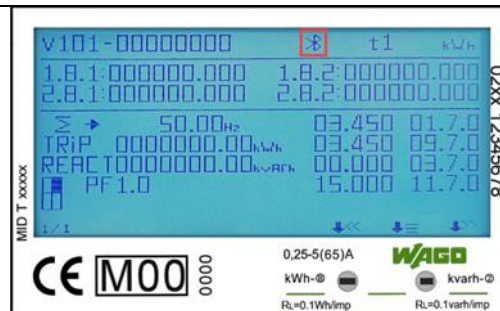

6.7 Settings via Buttons

Settings can also be made using the capacitive touch buttons on the front of the meter. Use the left and right buttons to cycle through the options. Press the middle button to confirm the settings. Select the menu icon (3 horizontal lines) to enter the settings menu:

4PU and 4PS

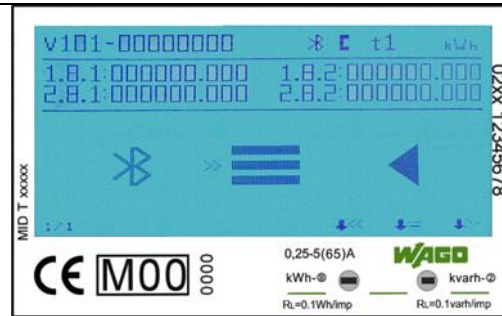

2PU CT

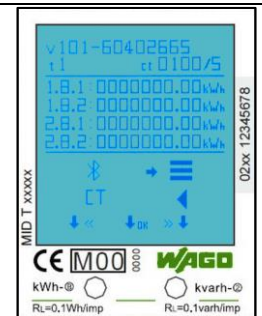

To access the settings menu, enter the 4-digit password (default 0000). Confirm each digit (0-9) by pressing the middle button:

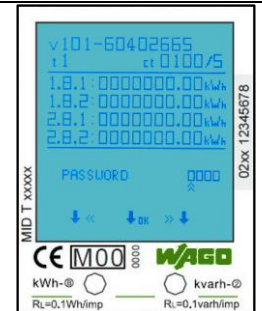
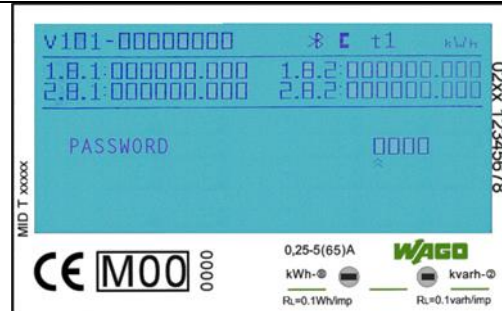

After entering the correct password, the settings menu appears:

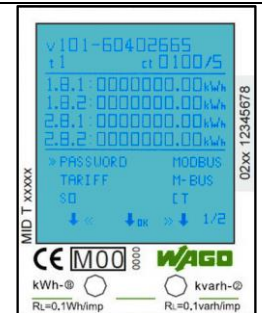
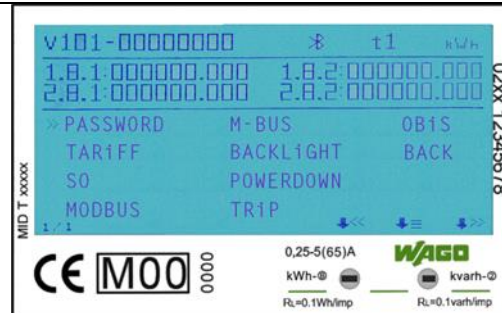

6.7.1 Password

The settings via the buttons are protected by a password. This password is also relevant for the settings via *Bluetooth*[®]. The password is 0000 by default. The password can only be changed using the buttons.

4PU and 4PS

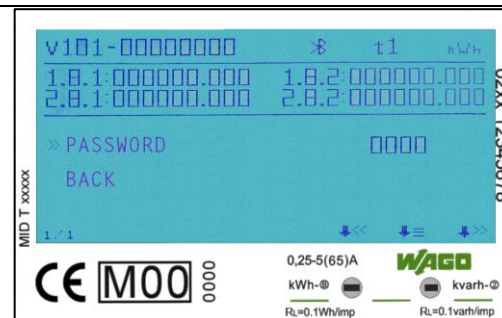

2PU CT

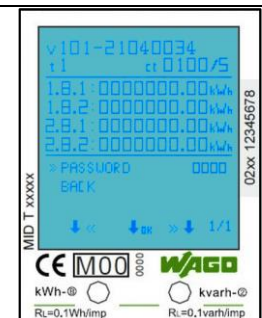

6.7.2 Tariff

When delivered, Tariff 1 is selected. The tariff to be used is selected via the WAGO Energy Configurator app or the settings menu. Tariff 2 can also be selected by applying a voltage (230 VAC) between terminal points 10 and 11. The energy values of all tariffs are shown in the middle area of the display. Tariffs 1 and 2 and Tariffs 3 and 4 are shown here in alternation.

4PU and 4PS

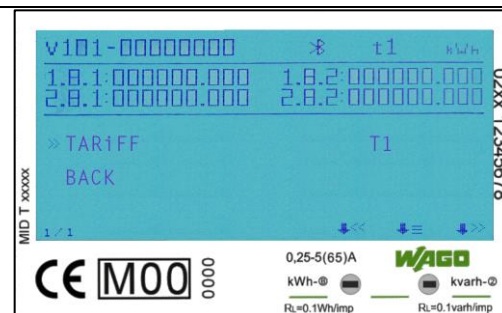

2PU CT

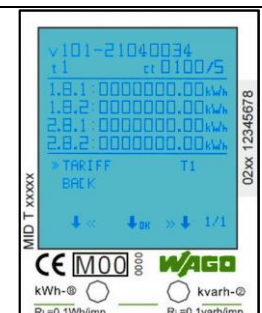

6.7.3 S0 Pulse Output

The energy meter is equipped with two configurable pulse outputs (forward and reverse; active and reactive) that are isolated from the internal circuit. The meter generates pulses based on the measured energies, which are used for remote reading or accuracy testing. The pulse outputs are polarity-dependent open-collector transistor outputs, which must each be supplied with an external voltage/pulse logger in order to function correctly. The applied voltage of the external voltage source (U_i) must not exceed 27 VDC. The maximum permissible switching current (I_{max}) is 100 mA. To evaluate the generated pulses with the WAGO I/O System 750, we recommend using the 4-channel digital input module (Item No. 750-409).

The meters have a pulse value of 1,000 pulses/kWh by default. The value setting can be changed to the following values both via the app and directly on the meter:

10,000 / 2,000 / 1,000 (standard) / 100 / 10 / 1 / 0.1 / 0.01 pulse/kWh.

4PU and 4PS

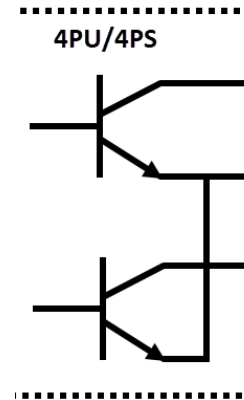

2PU CT

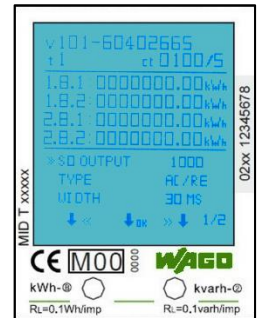
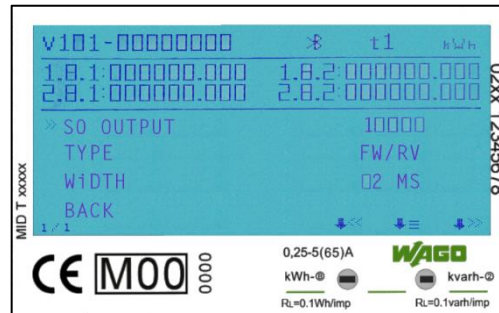
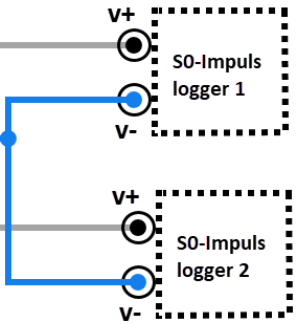

6.7.4 Pulse Type Setting

By default, the two interfaces pulsate based on the measured active and reactive energy. Optionally, this can be based on the forward and reverse active energy. This means that the two pulse outputs pulsate based on the active and reactive energy. The pulse type can be set to "Forward" and "Reverse", which means that the pulse outputs are generated based on the forward and reverse active energy.

4PU and 4PS

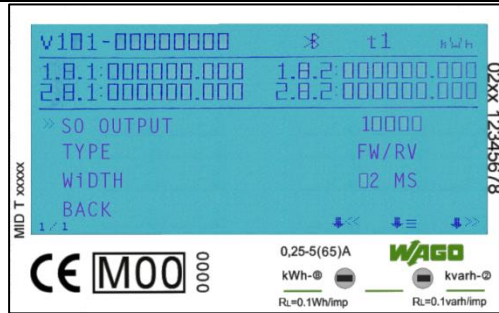

2PU CT

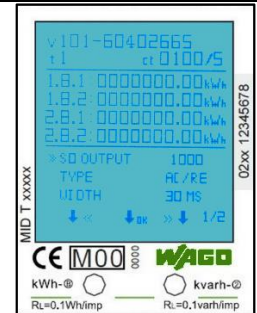

6.7.5 S0 Pulse Length

The default S0 pulse length is 30 ms. The setting for the pulse length can be changed to 2 ... 99 ms (depending on the set pulse value).

4PU and 4PS

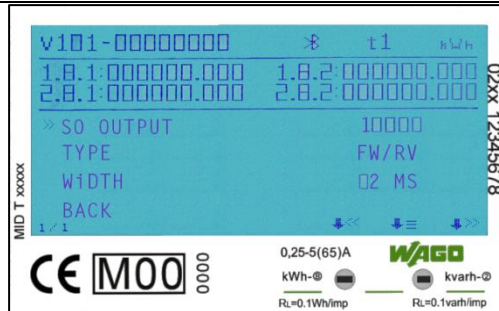

2PU CT

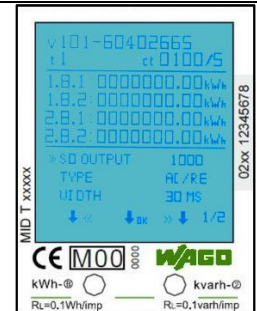

6.7.6 Modbus® ID

The Modbus® ID can be set from 1 to 247; the default Modbus® ID is set to 1.

4PU and 4PS

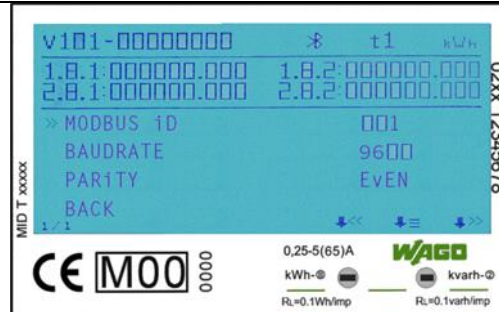

2PU CT

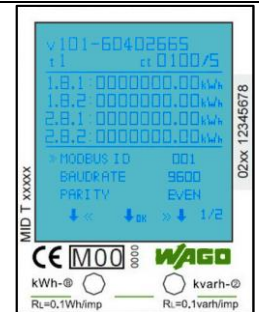

6.7.7 Modbus®-Baudrate

The default Modbus® baud rate is 9600 Bd. This can be changed to the following values:
115,200 / 56,700 / 38,400 / 19,200 / 9600 / 4800 / 2400 / 1200 / 600 / 300 Bd.

4PU and 4PS

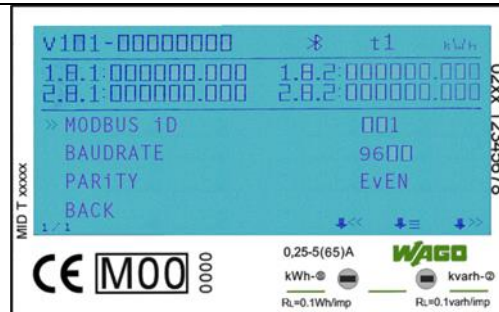

2PU CT

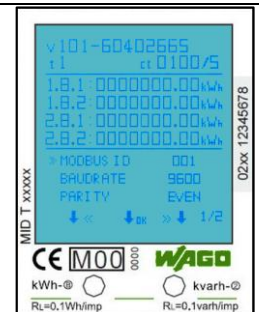

6.7.8 Modbus® Parity

The default Modbus® parity is even. This can be changed to the following values:
None / Odd / Even

4PU and 4PS



2PU CT

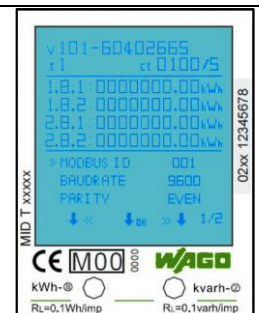

6.7.9 M-Bus-ID

The M-Bus ID can be freely set from 0 to 250; M-Bus ID 0 is configured by default.

4PU and 4PS

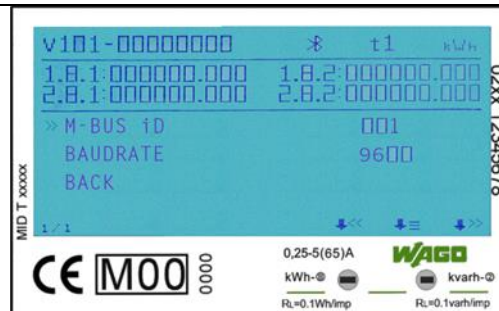

2PU CT

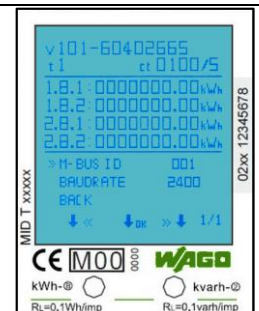

6.7.10 M-Bus Baud Rate

The default M-Bus baud rate is 2400 Bd. This can be changed to the following values:
9600 / 4800 / 2400 / 1200 / 600 / 300 Bd.

4PU and 4PS

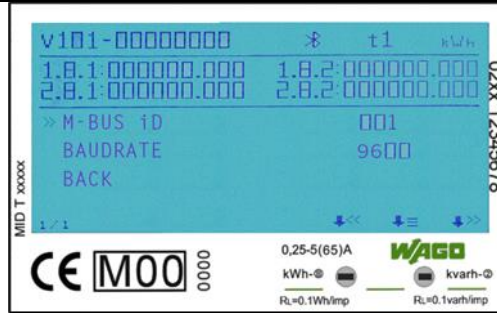

2PU CT

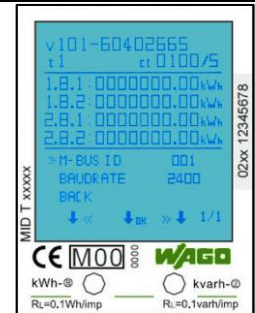

6.7.11 Backlight

The meter is equipped with a blue backlight. If desired, this can be switched to: permanently "on", permanently "off" or "on" when a button is pressed.

4PU and 4PS

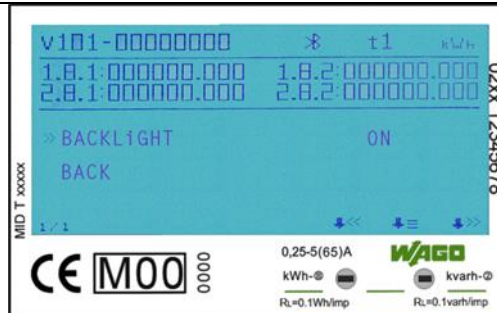

2PU CT

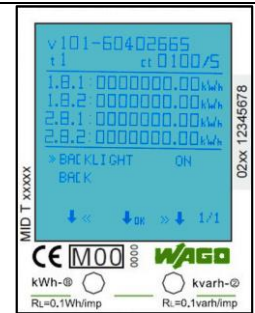

6.7.12 Power-down Counter

The power-down counter registers how many times the meter has been switched off.

4PU and 4PS

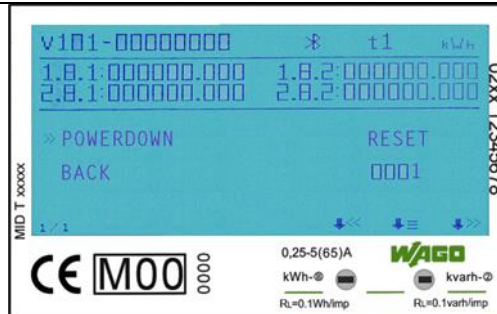

2PU CT

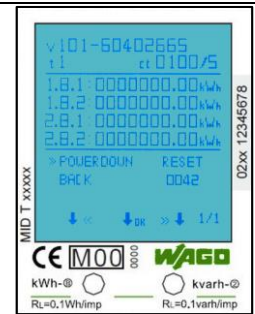

6.7.13 Trip Counter

The meter is equipped with a trip counter that can be reset to 0 at any time. This register runs parallel to the total energy register.

4PU and 4PS

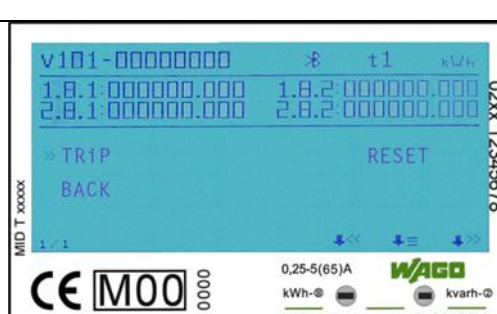

2PU CT

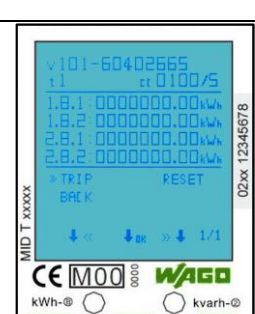

6.7.14 OBIS Codes

4PU und 4PS

2PU CT

OBIS codes can be used to identify the corresponding measured values. The OBIS codes are switched on by default.

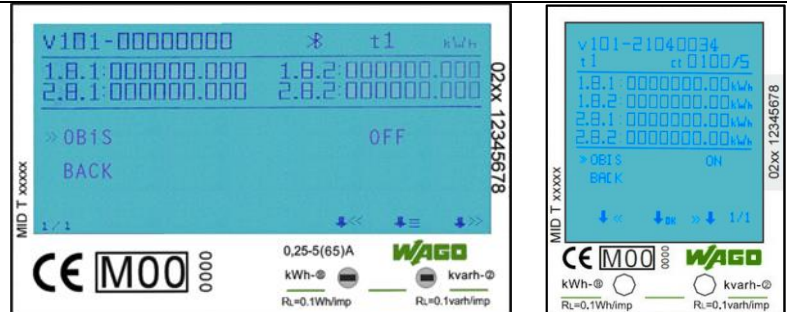

6.8 OBIS-Codes - Tables

All OBIS codes for all meter variants (4PU, 4PS, 2PU CT) are listed below. Additional values can also be read out via Bluetooth®. Below the tables (see also next page):

Values and OBIS codes shown in the display:				
OBIS-Code	Content		OBIS-Code	Content
Active Energy [kWh]			Active Power [kW]	
1.8.1	Forward Active Energy Tariff 1		15.7.0	Total Active Power*
1.8.2	Forward Active Energy Tariff 2		35.7.0	Total Active Power L1*
1.8.3	Forward Active Energy Tariff 3		55.7.0	Total Active Power L2*
1.8.4	Forward Active Energy Tariff 4		75.7.0	Total Active Power L3*
2.8.1	Reverse Active Energy Tariff 1		1.7.0	Total Active Power Forward
2.8.2	Reverse Active Energy Tariff 2		21.7.0	Forward Active Power L1
2.8.3	Reverse Active Energy Tariff 3		41.7.0	Forward Active Power L2
2.8.4	Reverse Active Energy Tariff 4		61.7.0	Forward Active Power L3
Reactive Energy [kvarh]			2.7.0	Total Active Power Reverse
-	Total Reactive Energy		22.7.0	Reverse Active Power L1
-	Total Reactive Energy L1		42.7.0	Reverse Active Power L2
-	Total Reactive Energy L2		62.7.0	Reverse Active Power L3
-	Total Reactive Energy L3		Reactive Power [kvar]	
Current [A]			3.7.0	Total Forward Reactive Power
11.7.0	Current		23.7.0	Forward Reactive Power L1
31.7.0	Current L1		43.7.0	Forward Reactive Power L2
51.7.0	Current L2		63.7.0	Forward Reactive Power L3
71.7.0	Current L3		4.7.0	Total Reverse Reactive Power
Voltage [V]			24.7.0	Reverse Reactive Power L1
32.7.0	Voltage L1		44.7.0	Reverse Reactive Power L2
52.7.0	Voltage L2		64.7.0	Reverse Reactive Power L3
72.7.0	Voltage L3		Apparent Power [kVA]	
Daily-Counter (resettable register) [kWh]			9.7.0	Total Apparent Power
-	Total Daily-Counter		29.7.0	Apparent Power L1
-	Daily-Counter L1		49.7.0	Apparent Power L2
-	Daily-Counter L2		69.7.0	Apparent Power L3
-	Daily-Counter L3			

* These values are displayed only on the 2PU CT (current transformer) meter.

Additional values and OBIS codes displayed in the Bluetooth® readout:

OBIS-Code	Content	OBIS-Code	Content
Active Energy [kWh]		Reactive Energy in quadrant 1 and 2 (Forward)	
1.8.0	Forward Active Energy	5.8.0	Inductive Forward Reactive Energy Q1 (Total)
15.8.0	Total Active Energy	5.8.1	Inductive Forward Reactive Energy Q1 (T1)
15.8.1	Total Active Energy T1	5.8.2	Inductive Forward Reactive Energy Q1 (T2)
15.8.2	Total Active Energy T2	5.8.3	Inductive Forward Reactive Energy Q1 (T3)
15.8.3	Total Active Energy T3	5.8.4	Inductive Forward Reactive Energy Q1 (T4)
15.8.4	Total Active Energy T4	6.8.0	Capacitive Forward Reactive Energy Q2 (Total)
35.8.0	Total Active Energy L1	6.8.1	Capacitive Forward Reactive Energy Q2 (T1)
55.8.0	Total Active Energy L2	6.8.2	Capacitive Forward Reactive Energy Q2 (T2)
75.8.0	Total Active Energy L3	6.8.3	Capacitive Forward Reactive Energy Q2 (T3)
21.8.0	Forward Active Energy L1	6.8.4	Capacitive Forward Reactive Energy Q2 (T4)
41.8.0	Forward Active Energy L2	Reactive Energy in quadrant 3 and 4 (Reverse)	
61.8.0	Forward Active Energy L3	7.8.0	Inductive Reverse Reactive Energy Q3 (Total)
2.8.0	Reverse Active Energy	7.8.1	Inductive Reverse Reactive Energy Q3 (T1)
22.8.0	Reverse Active Energy L1	7.8.2	Inductive Reverse Reactive Energy Q3 (T2)
42.8.0	Reverse Active Energy L2	7.8.3	Inductive Reverse Reactive Energy Q3 (T3)
62.8.0	Reverse Active Energy L3	7.8.4	Inductive Reverse Reactive Energy Q3 (T4)
Reactive Energy [kvarh]		8.8.0	Capacitive Reverse Reactive Energy Q4 (Total)
-	Total Reactive Energy T1	8.8.1	Capacitive Reverse Reactive Energy Q4 (T1)
-	Total Reactive Energy T2	8.8.2	Capacitive Reverse Reactive Energy Q4 (T2)
-	Total Reactive Energy T3	8.8.3	Capacitive Reverse Reactive Energy Q4 (T3)
-	Total Reactive Energy T4	8.8.4	Capacitive Reverse Reactive Energy Q4 (T4)
3.8.0	Forward Reactive Energy	Power Factor [cosφ]	
3.8.1	Forward Reactive Energy T1	13.7.0	Power Factor
3.8.2	Forward Reactive Energy T2	33.7.0	Power Factor L1
23.8.0	Forward Reactive Energy L1	53.7.0	Power Factor L2
43.8.0	Forward Reactive Energy L2	73.7.0	Power Factor L3
63.8.0	Forward Reactive Energy L3		
4.8.0	Reverse Reactive Energy	12.7.0	Voltage [V]
4.8.1	Reverse Reactive Energy T1	14.7.0	Frequency [Hz]
4.8.2	Reverse Reactive Energy T2	C.87.0	Active Tariff
24.8.0	Reverse Reactive Energy L1		
44.8.0	Reverse Reactive Energy L2		
64.8.0	Reverse Reactive Energy L3		

6.9 Set Transformer Ratio (2PU CT only)

The primary current can be set to 0001 ... 9999 A (with a secondary current of 1 A) or 0005 ... 9995 A (with a secondary current of 5 A). The secondary current can be set to /1 A or /5 A. A transformer ratio of CT=5/5 A is preset at the factory. The meter offers the option of adjusting the converter ratio up to 7 times in the password-protected settings menu (see 6.6.1). A CT history register is created to record all changes in the CT ratio. For each CT history, there is a specific register that stores the last transformer ratio and energy readings.



The image below shows that the transformer ratio (called RESETS) has already been changed three times. Three CT ratio changes require three CT HISTORY REGISTERS. So CT HISTORY -01 0005/5 A; -02 0100/5 A and -03 1100/5 A.

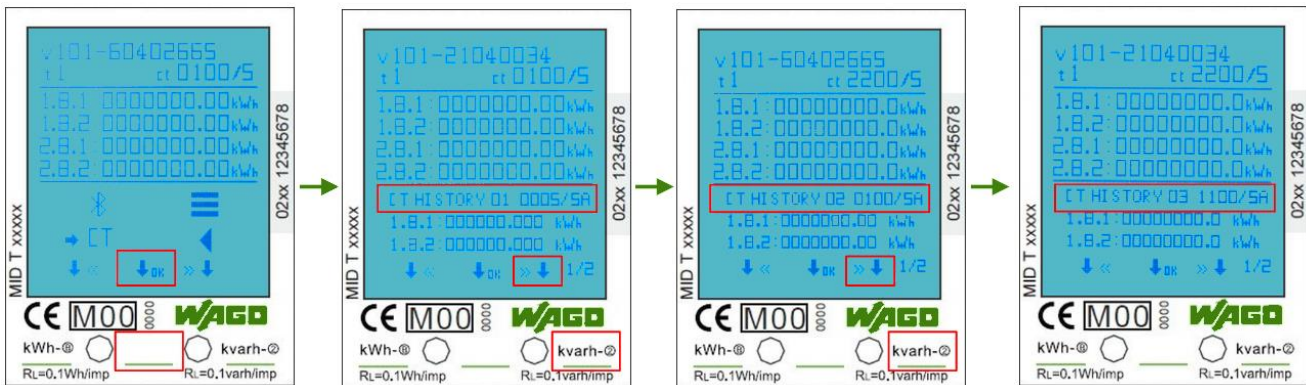

In the first image, entry into the submenu is confirmed with OK in the menu. In the following figures, the entries CT HISTORY 01 - CT HISTORY 03 are displayed by pressing the marked buttons. If other CT_HISTORY REGISTERS are written, they can be accessed by pressing the right button again.

Note:

CT DEFAULT: CT 0005/5

After the 1st SETTING (RESET), from CT 0005/5 to e.g., CT 0100/5, the 0005/5 ratio is stored in CT HISTORY 01: CT 0005/5. However, the meter continues to count with the setting CT 0005/5 in the Modbus® and display and the values are also shown in the display under CT HISTORY 01: CT 0005/5. The CT history register is available in Modbus® register 6100-619E. In addition, the last values of the energy values (OBIS codes 1.8.1, 1.8.2 and 2.8.1, 2.8.2) are shown with each CT change in the DISPLAY of the respective CT ratio. The 7th RESET is retained as the last CT setting.

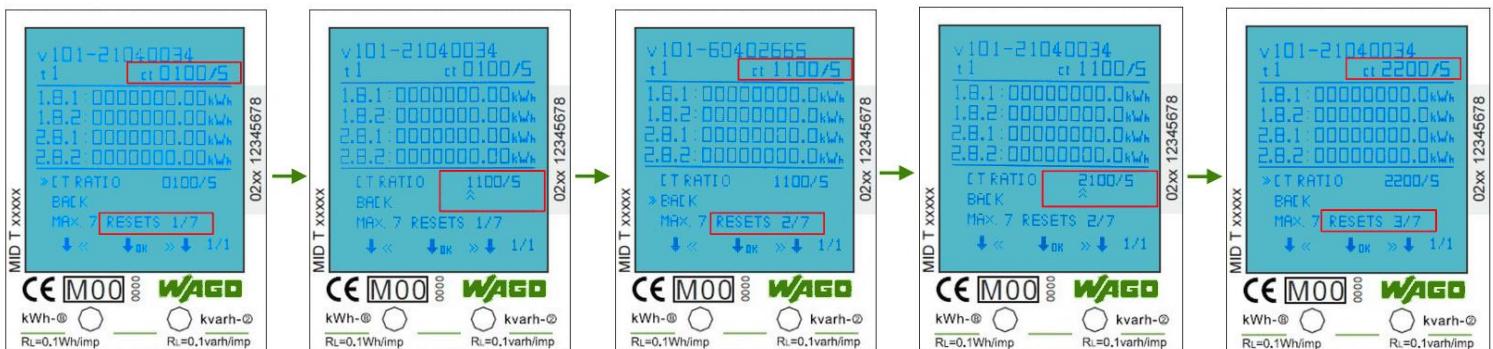

For the other example, the CT settings are shown in the table below.

Ex-factory transformer ratio CT=5/5				
Set CT number	CT active	CT new	Meter reading	History entry
0	CT _{5/5} =5/5A		0kWh	Hist. _{5/5} = continuous
1	CT _{5/5} =5/5A	CT ₁ =100/5A	1,111kWh	Hist._{CT1}=1,111kWh → fixed and unchangeable, then continuous with the new CT ratio to the next CT setting
2	CT ₁ =100/5A	CT ₂ =200/5A	2,222kWh	Hist._{CT2}=2,222kWh → fixed and unchangeable, then continuous with the new CT ratio to the next CT setting
3	CT ₂ =200/5A	CT ₃ =300/5A	3,333kWh	Hist._{CT3}=3,333kWh → fixed and unchangeable, then continuous with the new CT ratio to the next CT setting
4	CT ₃ =300/5A	CT ₄ =400/5A	4,444kWh	Hist._{CT4}=4,444kWh → fixed and unchangeable, then continuous with the new CT ratio to the next CT setting
5	CT ₄ =400/5A	CT ₅ =500/5A	5,555kWh	Hist._{CT4}=5,555kWh → fixed and unchangeable, then continuous with the new CT ratio to the next CT setting
6	CT ₅ =500/5A	CT ₆ =600/5A	6,666kWh	Hist._{CT4}=6,666kWh → fixed and unchangeable, then continuous with the new CT ratio to the next CT setting
7	CT ₆ =600/5A	CT ₇ =700/5A	7,777kWh	Hist._{CT7}=7,777kWh → fixed and unchangeable, then continuous with the new CT ratio but no further CT adjustment is possible

Summary of transformer ratio:

- Max. 7 CT-RESETS possible
- After the first RESET (here SET), the 5/5 ratio is saved in CT History 1 and continues to count.
- The next RESETS are stored in CT History 2-7 and do not count further.
- CT History registers are available in Modbus® register 6100-619E.

7 Troubleshooting

Notice

- When servicing, do not touch meter connectors directly with bare hands, metal, bare wires or other conductive material; it could cause an electric shock and result in serious injury or death.
- Before opening the protective cover, switch off all power sources of the energy meter and the devices connected to it and, if possible, lock them.

Warning

- Work on the devices may only be carried out by qualified specialist personnel who are familiar with the applicable rules and regulations.
- Use insulated tools when servicing or repairing the meter.
- Be sure to put the protective cover back on after maintenance or repair.
- The enclosure is sealed and must not be opened; failure to follow this instruction may result in damage to the meter.

Problem	Possible Cause	Testing / Solution
The red consumption LED on the front does not flash.	There is no load connected to the meter. The load on the line is very small.	Connect a load to the meter. Use an ohmmeter to check if the load reading is very low.
The counter does not count.	There is no load connected to the meter.	Check that the red consumption LED is flashing.
No pulse output	The pulse output is not supplied with DC voltage. The pulse output is not correctly connected.	Use a voltmeter to check whether the external voltage source (U_i) is 5 ... 27 VDC. Check whether the connection is correct: see Section 6.6.3 S0 Pulse Output
If none of the above works, please contact technical support.		

7.1 Error / Diagnostic Indication

All measured values are stored twice with the associated checksums. If the checksum fails, the backup data is used.

If both normal storage and backup fail, the meter will stop working and display error XX:

XX is the hexadecimal data; convert the data to binary values to analyze the data.

bit0: Data in the main memory and in the backup area of the accumulator is incorrect and cannot be used.

bit1: The mantissa area of the accumulator cannot be operated.

bit2: The backup area of the accumulator cannot be operated.

bit3: The main memory area of the accumulator cannot be operated.

bit4: Data error in the mantissa area of the accumulator

bit5: Data error in the battery backup area (integer bit)

bit6: Data error in accumulator main memory area (integer bit)

bit7: EEPROM cannot be fully initialized.

7.2 Technical Support

If you have any questions about our energy meter, please contact technical support:

Phone: +49 (0) 571/887 – 44555

Fax: +49 (0) 571/887 – 844555

Email: support@wago.com

Website: www.wago.com/support



Appendix 1 – Multi-Tariff Function

A1.1 Switching Tariffs between T1 and T2

The energy meter can optionally assign the measured values to different tariffs. Tariffs T1 and T2 can be controlled via an external tariff switch.

Once there is a voltage of 230 VAC at terminal blocks 10 and 11, the meter switches to Tariff 2 and writes the measured values to the register provided for T2.

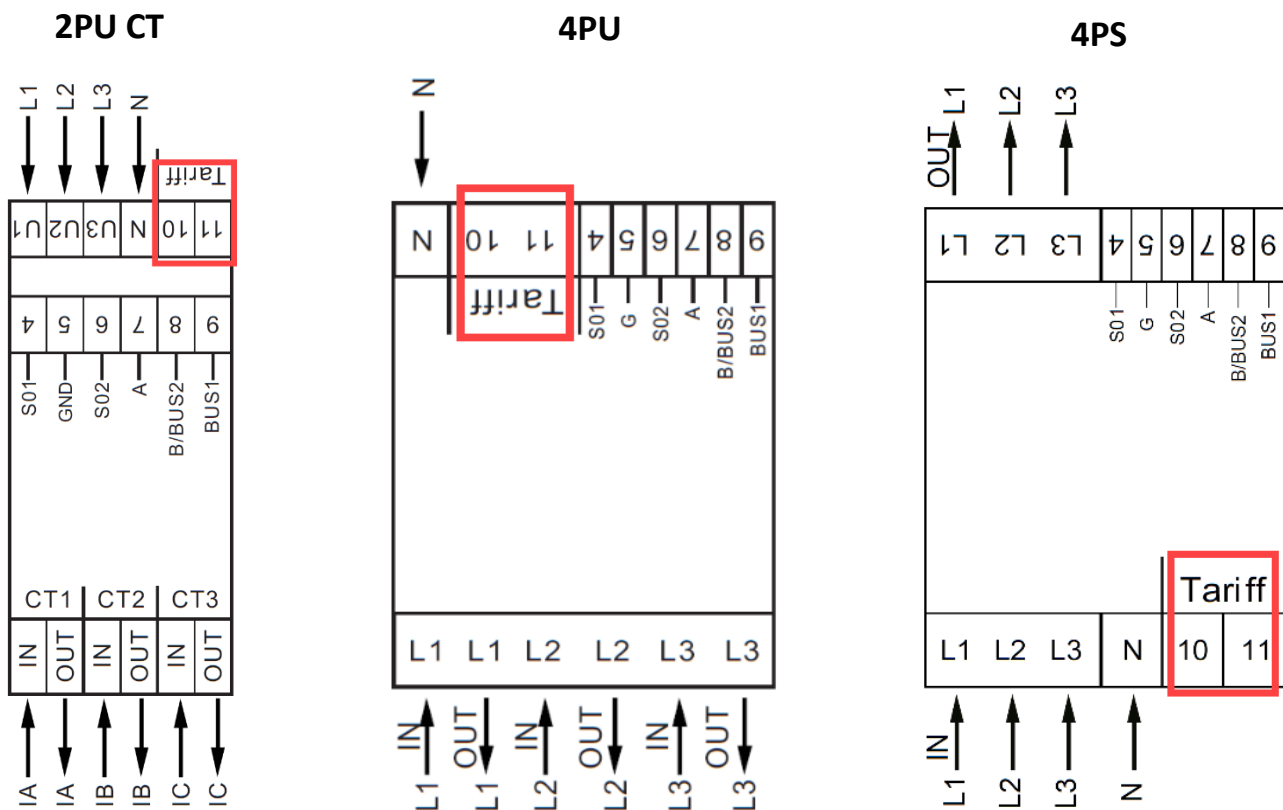

A1.2 Switching Tariffs to T3 and T4

Tariffs 3 and 4 can be enabled directly on the meter using the sensitive buttons or via the *Bluetooth*[®], Modbus[®] or M-Bus communication channels. Values that are included in these registers can also be found in area 2 (MID-relevant area) of the display. All values that are included in this area can no longer be removed or reset.

Appendix 2 – M-Bus

A2.1 Communication via the M-Bus Interface

The meters are equipped with an M-Bus connection via which the data can be read out. The communication protocol conforms to the EN13757-3 standard.

The meter can communicate with an M-Bus master. Use terminal points 8 and 9 to connect to the M-Bus network. The default communication address of the meter is 000.

The factory settings for the M-Bus are as follows:

- Baud rate 2400
- 8 data bits
- Parity: Even
- 1 stop bit

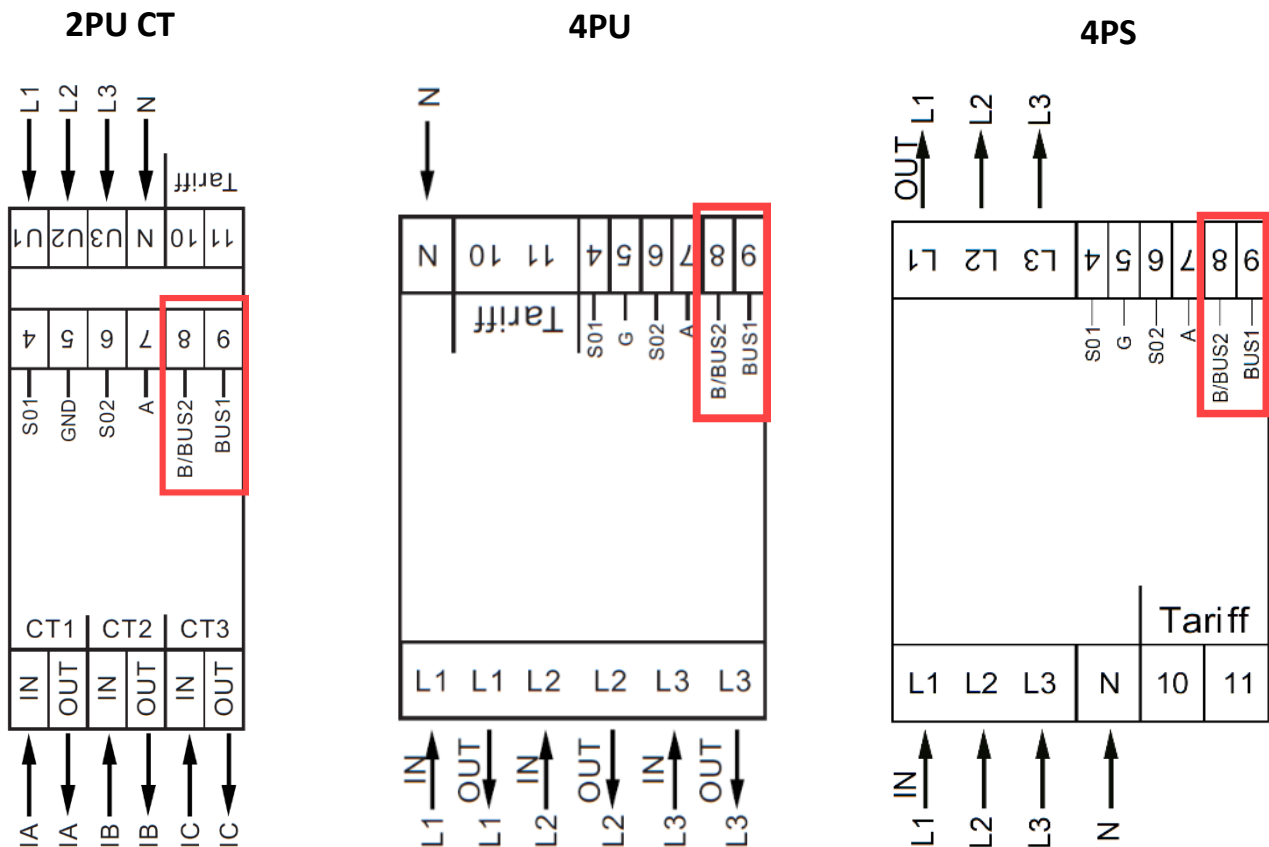

The secondary address (253/FD) is preset to the last 8 digits of the serial number. You will also find this printed vertically on the right-hand side of the front of the meter. This address can be changed to a desired address.

The baud rate can be changed to 9600, 4800, 2400, 1200, 600 and 300 baud.

Data, parity and stop bit cannot be changed.

The M-Bus register map on the next page shows which registers are used in the meter and how the data is to be interpreted.

More information on M-Bus is available here: www.m-bus.com

A2.2 M-Bus Register Map

M-Bus Befehl	Content	M-Bus register header DIF	M-Bus register VIF	Answer/example	Comment
1. REQ UD2: 10 5B xx					68 [data length] 68 08 [address] 72 [header] [datablocks] [checksum] 16
				68 xx xx 68 08 xx 72	
	Serial number			46 02 02 19	
	Manufacturer ID			CD 25	
	Version			01	As with the major version of the software
	Medium			02	Electricity
	No. of hits			04	Each time the meter is read, this number increases by 1 to 255, after which it returns to 0.
	Status			00	00 = OK 02 = Error
	Signature			00 00	Immer 00 00
	Total active energy import	04	03	15 CD 5B 07	123456789 Wh
	Active energy import T1	84 10	03	15 CD 5B 07	123456789 Wh
	Active energy import T2	84 20	03	15 CD 5B 07	123456789 Wh
	Active energy import T3	84 30	03	15 CD 5B 07	123456789 Wh
	Active energy import T4	84 80 10	03	15 CD 5B 07	123456789 Wh
	Total active energy export	04	83 3C	15 CD 5B 07	123456789 Wh
	Active energy export T1	84 10	83 3C	15 CD 5B 07	123456789 Wh
	Active energy export T2	84 20	83 3C	15 CD 5B 07	123456789 Wh
	Active energy export T3	84 30	83 3C	15 CD 5B 07	123456789 Wh
	Active energy export T4	84 80 10	83 3C	15 CD 5B 07	123456789 Wh
	Total kWh (resettable)	04	83 FC 10	15 CD 5B 07	123456789 Wh
	Reactive energy import	04	FB 82 73	15 CD 5B 07	123456.789 kVARh
	Reactive energy export	04	FB 82 F3 3C	15 CD 5B 07	123456.789 kVARh
	L1 voltage	02	FD C7 FC 01	E4 59	230.12 V
	L2 voltage	02	FD C7 FC 02	E4 59	230.12 V
	L3 voltage	02	FD C7 FC 03	E4 59	230.12 V
	L1 current	03	FD D9 FC 01	1B 87 01	100123 mA
	L2 current	03	FD D9 FC 02	1B 87 01	100123 mA
	L3 current	03	FD D9 FC 03	1B 87 01	100123 mA
	Total active power	03	2B	87 D6 12	1234567 W
	L1 active power	03	AB FC 01	87 D6 12	1234567 W
	L2 active power	03	AB FC 02	87 D6 12	1234567 W
	L3 active power	03	AB FC 03	79 29 ED	-1234567 W
	Total reactive power	03	FB 14	87 D6 12	1234.567 kVAR
	L1 reactive power	03	FB 94 FC 01	87 D6 12	1234.567 kVAR
	L2 reactive power	03	FB 94 FC 02	87 D6 12	1234.567 kVAR
	L3 reactive power	03	FB 94 FC 03	87 D6 12	1234.567 kVAR
	Total apparent power	03	FB 34	87 D6 12	1234.567 kVA
	Total power factor	0A	FD 3A	00 01	1.00
	Frequency	03	FB 2C	37 C7 00	50.999 Hz
	Tariff	09	7C 01 54	01	T1
	CT rate (for CT version only)	0A	FD 3A	05 95 99	9995/5
	Checksum			xx xx	xx 16

Data block

A2.3 M-Bus Write Register

Contents	Command part 1	Address	Command part 2	New value	Response	Remarks
Baud rate	68 03 03 68 53	01	-	BB	E5 (new baud rate 2400)	B8 = 300; B9 = 600; BA = 1200; BB = 2400; BC = 4800; BD = 9600
Primary address	68 06 06 68 53	01	51 01 7A	01	E5 (new ID 01)	000 - 250 HEX format
Secondary address	68 09 09 68 53	01	51 0C 79	15 01 23 45	E5 (new address 1501 2345)	4 bytes BCD format
Tariff	68 08 08 68 53	01	51 09 7C 01 54	02	E5 (Tariff 2)	T1 = 01 ; T2 = 02 ; T3 = 03 ; T = 04
Combinations Code	68 07 07 68 53	01	51 09 FD 3A	05	E5 (Combinations Code 05)	01, 02, 03, 04 and 05
S0 Rate	68 0A 0A 68 53	01	51 0C FD 3A	00 00 01 00	E5 (S0 Rate 100)	10,000 / 2,000 / 1,000 / 100 / 10 / 1 / 0.1 / 0.01
Resettable register (kWh)	68 09 09 68 53	01	51 0C 04	00 00 00 00	E5	Value is ignored, always reset to 0.
Reset power-down counter	68 08 08 68 53	01	51 0A FD 60	00 00	E5	Value is ignored, always reset to 0.

SND NKE	10 40	01	-	-	E5	Can be sent to the primary or secondary address and resets all communication values.
----------------	-------	----	---	---	----	--

Select slave via secondary addressing	Serial number	Manufacturer ID	Generation version	Medium
68 0B 0B 68 53 FD 52	aa aa aa aa	bb bb	cc	dd
Input	01 00 07 13	CD 25	01	02
Remarks	13070001	-	Major version of the software	Electricity

Appendix 3 – Modbus®

A3.1 Communication via the Modbus® Interface

The energy meter can communicate with Modbus® master devices on an RS-485 network. Use terminal points 7 and 8 to connect to the RS-485 network.

The factory-set Modbus® parameters are as follows:

- Modbus® address 001
- Baud rate 9600
- 8 data bits
- Parity: Even
- 1 stop bit

The baud rate can be changed to 115200, 56700, 38400, 19200, 9600, 4800, 2400, 1200, 600 and 300 baud. Parity can be set to even, odd and none. Data and stop bits cannot be changed.

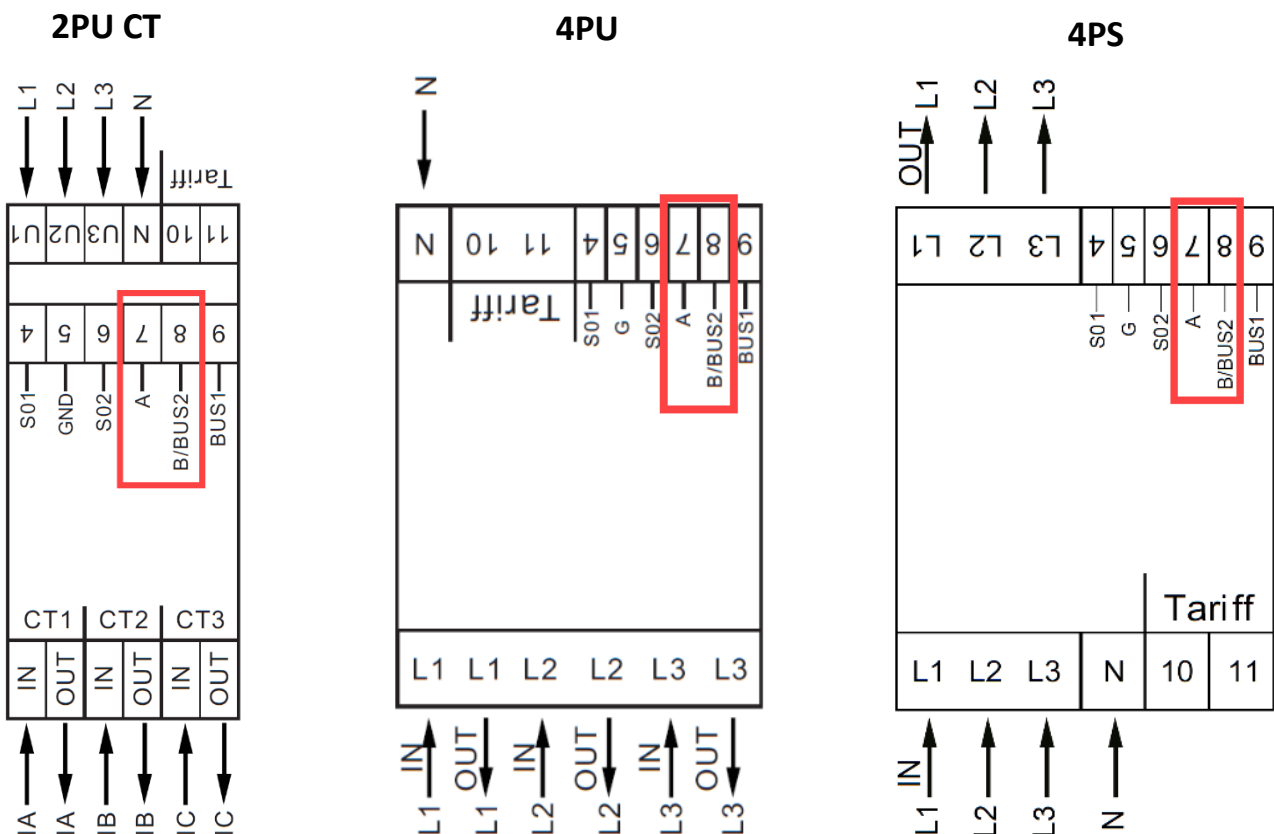

If you connect the meter via a serial converter (RS-485) for test purposes, please note that due to the incomplete implementation of the Modbus® infrastructure, an additional resistance (120 ohms / 0.25 watts) between terminal points (7 and 8) must be placed on the meter side.

Please see the Modbus® register map on the following pages for information on which registers are used in the meter and how the data is to be interpreted.

More information on Modbus® is available here:

Physical: http://www.modbus.org/docs/Modbus over serial line V1_02.pdf

Protocol: http://www.modbus.org/docs/Modbus Application Protocol V1_1b3.pdf

A3.2 Modbus Register Map

Reg. address	Content	Function code	Length	Unit	Data type
4000	Serial number	03	2	-	HEX
4002	Meter code <i>4PU: 1111 - 4PS: 1112 - 2PUCT: 1113</i>	03	1	-	HEX
4003	Modbus ID	03	1	-	Signed
4004	Baud rate <i>1: 300 - 2: 600 - 3: 1200 - 4: 2400 5: 4800 - 6: 9600 - 7: 19200 - 8: 38400 9: 57600 - 10: 115200</i>	03	1	-	Signed
4005	Protocol version	03	2	-	Float ABCD
4007	Software Version	03	2	-	Float ABCD
4009	Hardware version	03	2	-	Float ABCD
400B	Meter amp	03	1	A	Signed
400C	CT ratio	03	1	A	HEX
400D	S0 pulse rate	03	2	pulse/kWh	Float ABCD
400F	Combinations code <i>1: import only - 2: export only 3: import + export - 4: import - export 5: import - export (10)</i>	03	1	-	Signed
4010	LCD rolling time	03	1	sec.	HEX
4011	Parity <i>1: even - 2: none - 3: odd</i>	03	1	-	Signed
4012	L1 current direction <i>F: import - R: export</i>	03	1	-	ASCII
4013	L2 current direction <i>F: import - R: export</i>	03	1	-	ASCII
4014	L3 current direction <i>F: import - R: export</i>	03	1	-	ASCII
4016	Power-down counter	03	1	-	Signed
4017	Current quadrant	03	1	-	Signed
4018	L1 quadrant	03	1	-	Signed
4019	L2 quadrant	03	1	-	Signed
401A	L3 quadrant	03	1	-	Signed
401B	Checksum	03	2	-	HEX
401D	Active status word	03	2	-	HEX
401F	CT ratio <i>9995 005 = 9995/5</i>	03	2	A	Signed
4021	S0 pulse width <i>Value between 2-99 ms</i>	03	2	ms	Signed
4022	S0 pulse type <i>1: Active energy and reactive energy 2: import & export</i>	03	1	-	HEX
4023	Checksum 2 (not relevant)	03	2	-	HEX
4025	Reserved for later adjustments	-	1	-	-
4026	Data type <i>1: Standard - 2: Integer</i>	03	1	-	Signed

4027	Reserved for later adjustments	-	4	-	-
4032	Screen direction <i>0: Standard – 1: rotated 180°</i>	03	1	-	Signed
4033	OBIS code ON/OFF <i>0: OFF – 1: ON</i>	03	1	-	Signed

Reg. address	Content	Function code	Length	Unit	Data type
5000	Voltage*	03	2	V	Float ABCD
5002	L1 voltage	03	2	V	Float ABCD
5004	L2 voltage	03	2	V	Float ABCD
5006	L3 voltage	03	2	V	Float ABCD
5008	Frequency	03	2	Hz	Float ABCD
500A	Current*	03	2	A	Float ABCD
500C	L1 current	03	2	A	Float ABCD
500E	L2 current	03	2	A	Float ABCD
5010	L3 current	03	2	A	Float ABCD
5012	Total active power	03	2	kW	Float ABCD
5014	L1 active power	03	2	kW	Float ABCD
5016	L2 active power	03	2	kW	Float ABCD
5018	L3 active power	03	2	kW	Float ABCD
501A	Total reactive power	03	2	kvar	Float ABCD
501C	L1 reactive power	03	2	kvar	Float ABCD
501E	L2 reactive power	03	2	kvar	Float ABCD
5020	L3 reactive power	03	2	kvar	Float ABCD
5022	Total apparent power	03	2	kVA	Float ABCD
5024	L1 apparent power	03	2	kVA	Float ABCD
5026	L2 apparent power	03	2	kVA	Float ABCD
5028	L3 apparent power	03	2	kVA	Float ABCD
502A	Power factor	03	2	-	Float ABCD
502C	L1 power factor	03	2	-	Float ABCD
502E	L2 power factor	03	2	-	Float ABCD
5030	L3 power factor	03	2	-	Float ABCD
5032	L1-L2 voltage	03	2	V	Float ABCD
5034	L1-L3 voltage	03	2	V	Float ABCD
5036	L2-L3 voltage	03	2	V	Float ABCD

Reg. address	Content	Function code	Length	Unit	Data type
6000	Total active energy	03	2	kWh	Float ABCD
6002	T1 Total active energy	03	2	kWh	Float ABCD
6004	T2 Total active energy	03	2	kWh	Float ABCD
6006	L1 Total active energy	03	2	kWh	Float ABCD
6008	L2 Total active energy	03	2	kWh	Float ABCD
600A	L3 Total active energy	03	2	kWh	Float ABCD
600C	Active energy import	03	2	kWh	Float ABCD
600E	T1 Active energy import	03	2	kWh	Float ABCD
6010	T2 Active energy import	03	2	kWh	Float ABCD
6012	L1 Active energy import	03	2	kWh	Float ABCD
6014	L2 Active energy import	03	2	kWh	Float ABCD
6016	L3 Active energy import	03	2	kWh	Float ABCD
6018	Active energy export	03	2	kWh	Float ABCD
601A	T1 Active energy export	03	2	kWh	Float ABCD
601C	T2 Active energy export	03	2	kWh	Float ABCD
601E	L1 Active energy export	03	2	kWh	Float ABCD
6020	L2 Active energy export	03	2	kWh	Float ABCD
6022	L3 Active energy export	03	2	kWh	Float ABCD
6024	Total reactive energy	03	2	kvarh	Float ABCD
6026	T1 Total reactive energy	03	2	kvarh	Float ABCD
6028	T2 Total reactive energy	03	2	kvarh	Float ABCD
602A	L1 Total reactive energy	03	2	kvarh	Float ABCD
602C	L2 Total reactive energy	03	2	kvarh	Float ABCD
602E	L3 Total reactive energy	03	2	kvarh	Float ABCD
6030	Reactive energy import	03	2	kvarh	Float ABCD
6032	T1 Reactive energy import	03	2	kvarh	Float ABCD
6034	T2 Reactive energy import	03	2	kvarh	Float ABCD
6036	L1 Reactive energy import	03	2	kvarh	Float ABCD
6038	L2 Reactive energy import	03	2	kvarh	Float ABCD
603A	L3 Reactive energy import	03	2	kvarh	Float ABCD
603C	Reactive energy export	03	2	kvarh	Float ABCD
603E	T1 Reactive energy export	03	2	kvarh	Float ABCD
6040	T2 Reactive energy export	03	2	kvarh	Float ABCD

6042	L1 Reactive energy export	03	2	kvarh	Float ABCD
6044	L2 Reactive energy export	03	2	kvarh	Float ABCD
6046	L3 Reactive energy export	03	2	kvarh	Float ABCD
6048	Tariff	03	1	-	Signed
6049	Resettable day register	03	2	kWh	Float ABCD
604B	T3 Total active energy	03	2	kWh	Float ABCD
604D	T4 Total active energy	03	2	kWh	Float ABCD
604F	T3 Import active energy	03	2	kWh	Float ABCD
6051	T4 Import active energy	03	2	kWh	Float ABCD
6053	T3 Export active energy	03	2	kWh	Float ABCD
6055	T4 Export active energy	03	2	kWh	Float ABCD
6057	T3 Total reactive energy	03	2	kvarh	Float ABCD
6059	T4 Total reactive energy	03	2	kvarh	Float ABCD
605B	T3 Import reactive energy	03	2	kvarh	Float ABCD
605D	T4 Import reactive energy	03	2	kvarh	Float ABCD
605F	T3 Export reactive energy	03	2	kvarh	Float ABCD
6061	T4 Export reactive energy	03	2	kvarh	Float ABCD
6063	Import inductive reactive energy in Q1 (total)	03	2	kvarh	Float ABCD
6065	Import inductive reactive energy in Q1 (T1)	03	2	kvarh	Float ABCD
6067	Import inductive reactive energy in Q1 (T2)	03	2	kvarh	Float ABCD
6069	Import inductive reactive energy in Q1 (T3)	03	2	kvarh	Float ABCD
606B	Import inductive reactive energy in Q1 (T4)	03	2	kvarh	Float ABCD
606D	Import capacitive reactive energy in Q2 (total)	03	2	kvarh	Float ABCD
606F	Import capacitive reactive energy in Q2 (T1)	03	2	kvarh	Float ABCD
6071	Import capacitive reactive energy in Q2 (T2)	03	2	kvarh	Float ABCD
6073	Import capacitive reactive energy in Q2 (T3)	03	2	kvarh	Float ABCD
6075	Import capacitive reactive energy in Q2 (T4)	03	2	kvarh	Float ABCD
6077	Export inductive reactive energy in Q3 (total)	03	2	kvarh	Float ABCD
6079	Export inductive reactive energy in Q3 (T1)	03	2	kvarh	Float ABCD
607B	Export inductive reactive energy in Q3 (T2)	03	2	kvarh	Float ABCD
607D	Export inductive reactive energy in Q3 (T3)	03	2	kvarh	Float ABCD
607F	Export inductive reactive energy in Q3 (T4)	03	2	kvarh	Float ABCD
6081	Export capacitive reactive energy in Q4 (total)	03	2	kvarh	Float ABCD
6083	Export capacitive reactive energy in Q4 (T1)	03	2	kvarh	Float ABCD

6085	Export capacitive reactive energy in Q4 (T2)	03	2	kvarh	Float ABCD
6087	Export capacitive reactive energy in Q4 (T3)	03	2	kvarh	Float ABCD
6089	Export capacitive reactive energy in Q4 (T4)	03	2	kvarh	Float ABCD
608B	Resettable day register L1	03	2	kWh	Float ABCD
608D	Resettable day register L2	03	2	kWh	Float ABCD
608F	Resettable day register L3	03	2	kWh	Float ABCD

A3.3 Modbus® Write Register

Reg. address	Content	Function code	Length	Unit	Data type
4003	Modbus® ID	06	1	-	Signed
Command:	01 06 4003 000A (new ID: 10)		01~247 - 01 standard - 00 broadcast		
4004	Baud rate	06	1	-	Signed
Command:	01 06 4004 00 06 (new baud rate: 9600)		1: 300 - 2: 600 - 3: 1200 - 4: 2400 5: 4800 - 6: 9600 - 7: 19200 8: 38400 - 9: 57600 - 10: 115200		
400D	S0 pulse rate	10	2	pulse/kWh	Float ABCD
Command:	01 10 400D 0002 04 41 20 00 00 (new S0: 10)		10,000 - 2,000 - 1,000 - 100 - 10 - 1 0.1 - 0.01		
400F	Combinations code	06	1	-	Signed
Command:	01 06 400F 0004 (new code: 4 F-R)		1: import only - 2: export only 3: import + export; 4: import - export 5: import - export (10)		
4010	LCD rolling time	06	1	Seconds	HEX
Command:	01 06 4010 0025 (new time: 25 sec.)		01~30		
4011	Parity	06	1	-	Signed
Command:	01 06 4011 0002 (new parity: none)		01: even - 02: none - 03: odd		
4016	Power-down counter	06	1	-	Signed
Command:	01 06 4016 0000		Reset to 0		
6048	Tariff	06	1	-	Signed
Command:	01 06 6048 0002 (new tariff: 2)		1: T1 - 2: T2 - 3: T3 - 4: T4		
6049	Resettable day register	10	1	kWh	Float ABCD
Command:	01 10 6049 0002 04 0000 0000		Reset to 0		
401F	CT ratio	06	2	-	Signed
Command:	01 10 401F 0002 04 9995 0005		Set to 9995/5		
4021	Pulse width	06	1	ms	4021
Command:	01 06 4021 0030 (new width: 30ms)		2~99 ms		
4022	Pulse type	06	1	-	4022
Command:	01 06 4022 0002 (new setting: import and export)		2 = forward & reverse		
4026	Data type	06	1	-	4026
Command:	01 06 4026 0002 (new setting: integer)		1 = standard, 2 = integer		
4032	Screen direction	06	1	-	4032
Command:	01 06 4032 0001 (new setting: rotate 180°)		0: standard - 1: rotated 180°		
4033	OBIS code ON/OFF	06	1	0 =	Signed
Command:	01 06 4033 0001 (new setting: OBIS ON)		0: OFF - 1: ON		

WAGO GmbH & Co. KG

Postfach 2880 – 32385 Minden
Hansastraße 27 – 32423 Minden
info@wago.com
www.wago.com

HQ	+49 571/887 - 0
Sales	+49 571/887 - 44 222
Order Service	+49 571/887 - 44 333
Fax	+49 571/887 - 844 169

WAGO is a registered trademark of WAGO Verwaltungsgesellschaft mbH.

“Copyright – WAGO GmbH & Co. KG – All rights reserved. The content and structure of the WAGO websites, catalogs, videos and other WAGO media are subject to copyright. Distribution or modification of the contents of these pages and videos is prohibited. Furthermore, the content may not be copied or made available to third parties for commercial purposes. Also subject to copyright are the images and videos that were made available to WAGO GmbH & Co. KG by third parties.”

X-ON Electronics

Largest Supplier of Electrical and Electronic Components

Click to view similar products for [Specialist Controllers](#) category:

Click to view products by [Wago](#) manufacturer:

Other Similar products are found below :

[CV500SLK21](#) [81550401](#) [H2CRSAC110B](#) [R88ARR080100S](#) [E53E01](#) [E53E8C](#) [E5GNQ03PFLKACDC24](#) [B300LKL21](#) [NSCXDC1V3](#)
[NT20SST122BV1](#) [C40PEDRA](#) [K31S5](#) [K31S6](#) [K3TX-AD31A](#) [L595020](#) [26546803](#) [26546805](#) [H7HP-C8D](#) [PWRA440A](#) [CPM1AETL03CH](#)
[3G2A5BI081](#) [3G2A5IA122](#) [3G2A5OD211](#) [3G2A5RM001EV1](#) [3G2A5RT002EV1](#) [3G2A6-ID217](#) [3G2A6LK202EV1](#) [3G2A9AL004E](#)
[C200HETL01E](#) [C200PCPD024](#) [3G2A5AD001](#) [3G2A5BI051](#) [3G2A5IA121](#) [3G2A5ID112](#) [3G2A5ID213](#) [3G2A5ID219](#) [3G2A5MR431](#)
[3G2A5OC221](#) [3G2A5PS222E](#) [3G2A6IM213](#) [3G2A6-OD412](#) [3G2A9AL001](#) [3G2C7LK202EV1](#) [3G5A2OC221E](#) [LDP2TA2B115](#)
[3G3DV130B4294](#) [E53E04](#) [E53Q4Q4](#) [E54E8CT](#) [C200HWCOM06EV1](#)