

Board Level Heat Sinks

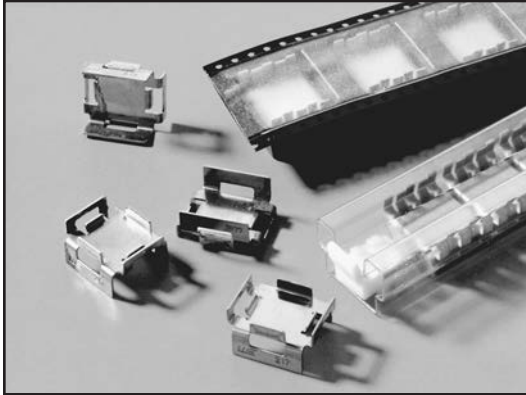

BOARD LEVEL POWER SEMICONDUCTOR HEAT SINKS



217 SERIES Surface Mount Heat Sinks

D²PAK, TO-220, SOT-223, SOL-20

Compatible with surface mount technology (SMT) automated production techniques for ease of assembly and a variety of soldering methods, these heat sinks allow greater packaging densities and reduction in PC-board area, increasing the power dissipation of surface mount devices (SMDs) while maintaining and improving manufacturers' component thermal specifications.

FEATURES AND BENEFITS:

- No interface material is needed
- Copper with matte tin plating for improved solderability and assembly
- Both the component and the heat sink are installed on the PC-board utilizing standard SMT assembly equipment for "Tape & Reel" and "Tube" formats
- EIA standards and ESD protection are specified
- Can be used with water soluble or no clean SMT solder creams or other pastes

Standard P/N	Height Above PC Board in. (mm)	Footprint Dimensions in. (mm)	Package Format	Package Quantity	Thermal Performance at Typical Load	
					Natural Convection	Forced Convection
217-36CTE6	.360 (9.1)	.600 (15.2) x .740 (18.8)	Bulk	1	55°C @ 1W	16.0°C/W @ 200 LFM
217-36CTTE6	.360 (9.1)	.600 (15.2) x .740 (18.8)	Tube	20	55°C @ 1W	16.0°C/W @ 200 LFM
217-36CTRE6	.360 (9.1)	.600 (15.2) x .740 (18.8)	Tape & Reel	250	55°C @ 1W	16.0°C/W @ 200 LFM

Material: Copper, Matte Tin Plated

MECHANICAL DIMENSIONS

217 HEAT SINK WITH D²PAK DEVICE

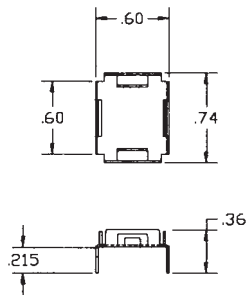

217-36CT6

THERMAL PERFORMANCE 6 LAYER BOARD, D²PAK 125°C LEAD, 40°C AMBIENT

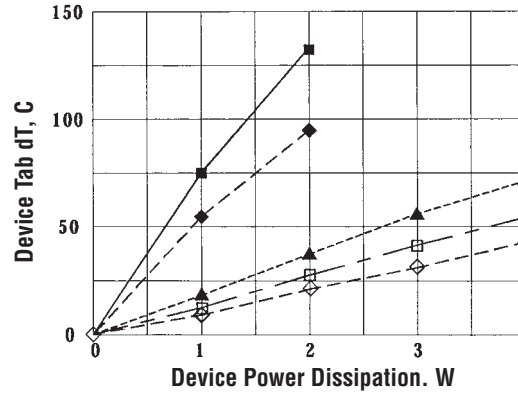

KEY: ■ Device only, NC ◆ Device + HS, NC ▲ Device + HS, 100 lfm □ Device + HS, 200 lfm ◇ Device + HS, 300 lfm

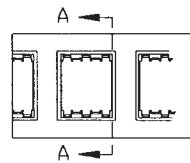

SECTION A-A

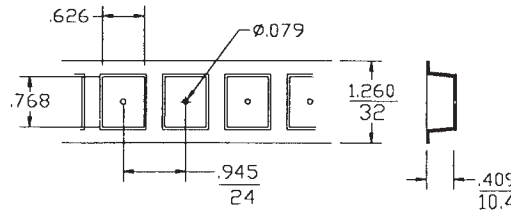

TAPE DETAILS

- NOTES**
1. Material to be "ESD"
 2. Approximately 6 Meters per Reel
 3. 250 Pieces per Reel.

217-36CTR6

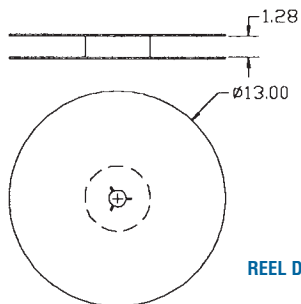

REEL DETAILS

Dimensions: in.

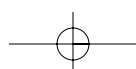

BOARD LEVEL POWER SEMICONDUCTOR HEAT SINKS

217 SERIES Surface Mount Heat Sinks

D²PAK, TO-220, SOL-20

MECHANICAL DIMENSIONS

217 SERIES

TUBE DETAILS

TUBE: 16.25 Inches Long,
Min. ESD Material with Nail
Stops
20 Pieces per Tube

217-36CTT6

BOARD LAYOUT RECOMMENDATIONS

USE MAX COPPER TO ALLOW MAX CONDUCTION TO HEAT SINK

REF: JEDEC TO-220AB
SOLDER MASK OPENING

REF: JEDEC TO-263 (DD PAK)
REF: JEDEC MO-169 (DD PAK)

COPPER FOOTPRINT FOR HEATSINK

MIN COPPER FOR HEATSINK

SOL 20

217-36CT6

Dimensions: in.

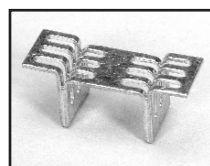

218 SERIES Surface Mount Heat Sink

SMT Devices

Standard P/N	Height Above PC Board in. (mm)	Maximum Footprint in. (mm)	Thermal Performance at Typical Load	
			Natural Convection	Forced Convection
218-40CTE3	.40 (10.2)	.90 (22.9) x .315 (8.0)	62°C rise @ 2W	21°C/W @ 200LFM
218-40CTE5	.40 (10.2)	1.03 (26.2) x .50 (12.7)	62°C rise @ 2W	21°C/W @ 200LFM

Material: Copper, Matte Tin Plated

MECHANICAL DIMENSIONS

RECOMMENDED Cu HEAT SPREADER DRAIN PAD

RECOMMENDED HEAT SINK SOLDER MASK OPENING

218-40CT3

218-40CT5

NATURAL AND FORCED CONVECTION CHARACTERISTICS

Solid line = 218-40CT5 Dashed Line = 218-40CT3

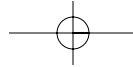

Board Level Heat Sinks



BOARD LEVEL POWER SEMICONDUCTOR HEAT SINKS

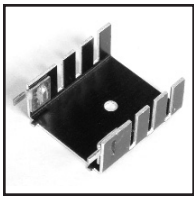

206 SERIES Vertical Mount Heat Sink

TO-220

Standard P/N	Height Above PC Board in. (mm)	Maximum Footprint in. (mm)	Thermal Performance at Typical Load	
			Natural Convection	Forced Convection
206-1PABEH	1.18 (30.0)	1.00 (25.4) x .50 (12.7)	56°C rise @ 4W	7.3°C/W @ 200LFM

Material: Aluminum, Black Anodized

MECHANICAL DIMENSIONS

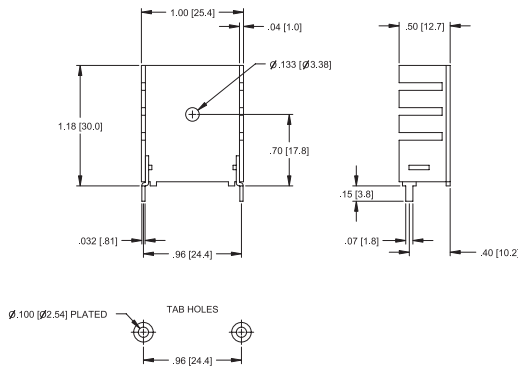

NATURAL AND FORCED CONVECTION CHARACTERISTICS

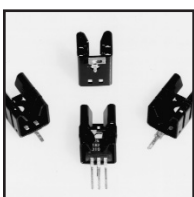
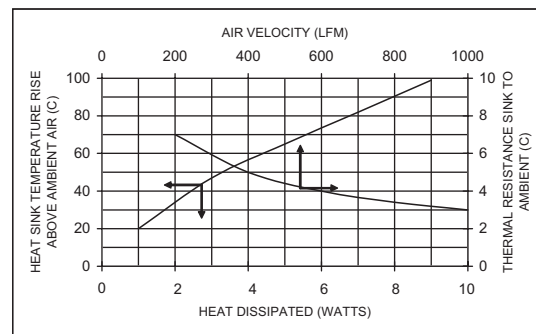

230 & 234 SERIES Compact, Wavesolderable Low-Profile Self-Locking Heat Sinks

TO-220

PATENT PENDING

Standard P/N	Height Above PC Board in. (mm)	Footprint Dimensions in. (mm)	Mounting Configuration	Solderable Tab Option	Mounting Style	Thermal Performance at Typical Load	
						Natural Convection	Forced Convection
230-75AB	.750 (19.1)	.570 (14.5) x .500 (12.7)	Vert./Horiz.	No Tab	Clip/Mtg Hole	57°C @ 2W	7.5°C/W @ 400 LFM
230-75ABE-01	.750 (19.1)	.570 (14.5) x .500 (12.7)	Vertical	01	Clip/Mtg Hole	57°C @ 2W	7.5°C/W @ 400 LFM
230-75ABE-05	.500 (12.7)	.750 (19.1) x .570 (14.5)	Horizontal	05	Clip/Mtg Hole	57°C @ 2W	7.5°C/W @ 400 LFM
230-75ABE-10	.875 (22.2)	.570 (14.5) x .500 (12.7)	Vertical	10	Clip/Mtg Hole	57°C @ 2W	7.5°C/W @ 400 LFM
234-75AB	.790 (20.0)	.570 (14.5) x .500 (12.7)	Vert./Horiz.	No Tab	Clip/Mtg Hole	57°C @ 2W	7.5°C/W @ 400 LFM
234-75ABE-01	.790 (20.0)	.570 (14.5) x .500 (12.7)	Vertical	01	Clip/Mtg Hole	57°C @ 2W	7.5°C/W @ 400 LFM
234-75ABE-05	.500 (12.7)	.790 (20.0) x .570 (14.5)	Horizontal	05	Clip/Mtg Hole	57°C @ 2W	7.5°C/W @ 400 LFM

Material: Aluminum, Black Anodized

MECHANICAL DIMENSIONS

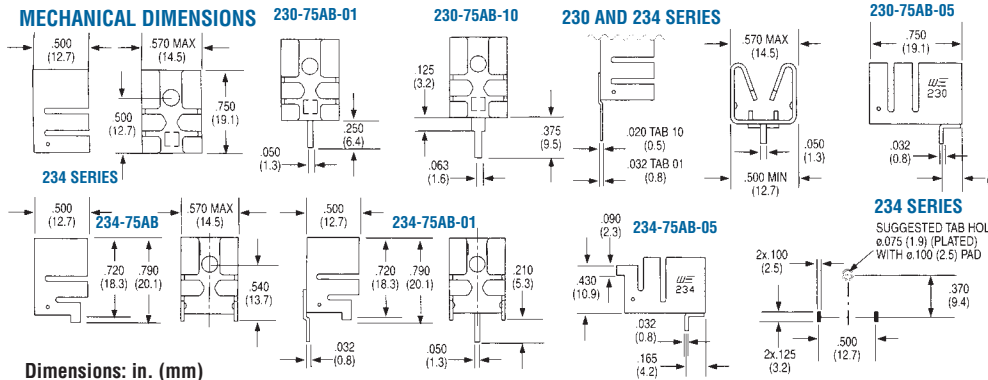

230 SERIES

SUGGESTED TAB HOLE= ø.075 (1.9) (PLATED) WITH ø.100 (2.5) PAD

NATURAL AND FORCED CONVECTION CHARACTERISTICS

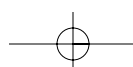
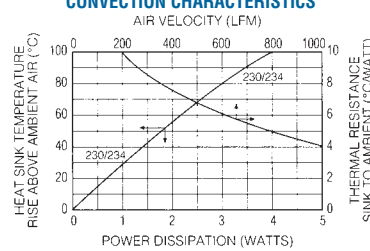



BOARD LEVEL POWER SEMICONDUCTOR HEAT SINKS

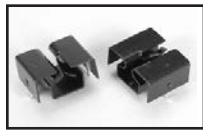

241 SERIES *Horizontal Mount Heat Sink*

TO-220

Standard P/N	Height Above PC Board in. (mm)	Maximum Footprint in. (mm)	Thermal Performance at Typical Load	
			Natural Convection	Forced Convection
241-69ABE-03	.39 (9.9)	.86 (21.8) x .69 (17.5)	77°C rise @ 4W	12°C/W @ 200LFM

Material: Aluminum, Black Anodized

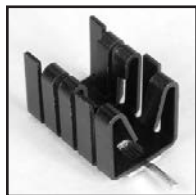
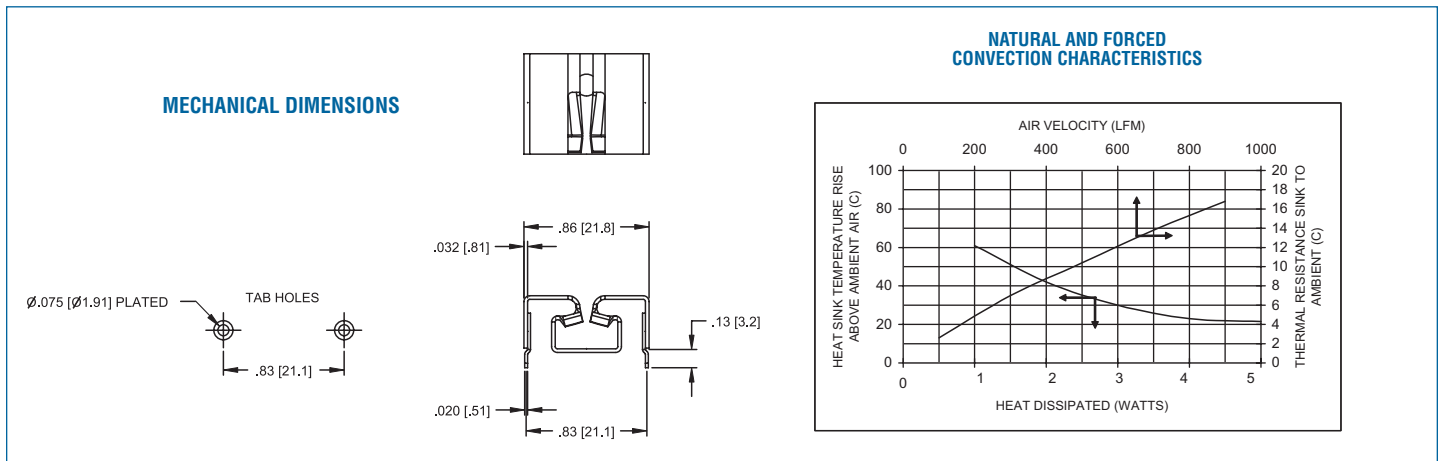

262 SERIES *Horizontal and Vertical Mount Heat Sink*

TO-220

Standard P/N	Height Above PC Board in. (mm)	Maximum Footprint in. (mm)	Thermal Performance at Typical Load	
			Natural Convection	Forced Convection
262-75ABE-05	.53 (13.4)	.75 (19.1) x .50 (12.78)	80°C rise @ 2W	10°C/W @ 200LFM
262-75ABE-01	.75 (19.1)	.53 (13.4) x .50 (12.7)	80°C rise @ 2W	10°C/W @ 200LFM

Material: Aluminum, Black Anodized

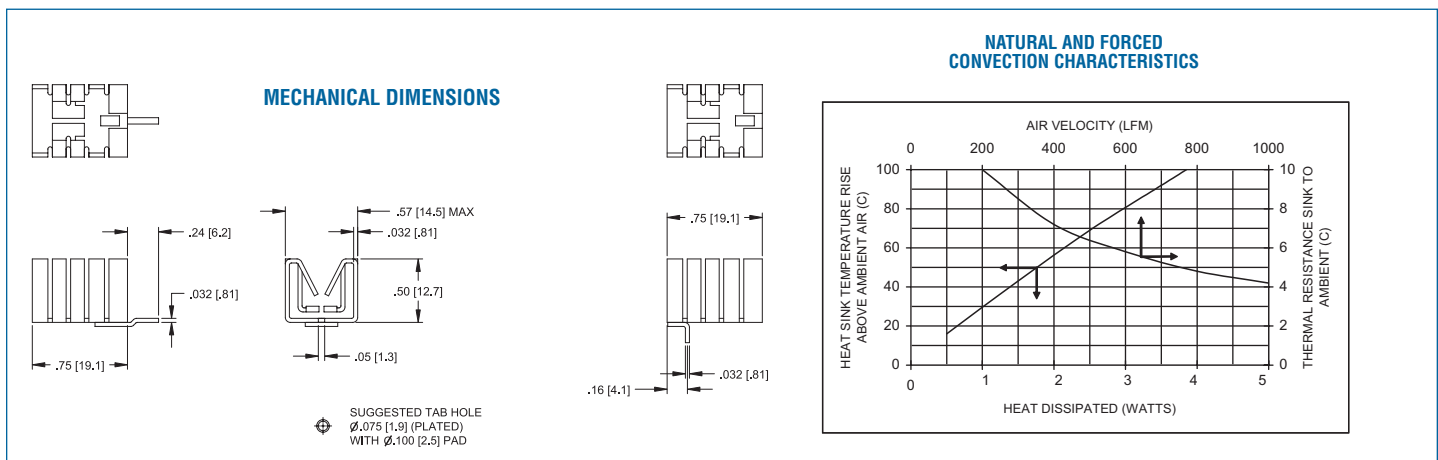

Board Level Heat Sinks



BOARD LEVEL POWER SEMICONDUCTOR HEAT SINKS

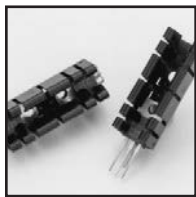

PATENT PENDING

233 & 236 SERIES

Self-Locking Wavesolderable Heat Sinks

TO-220

Standard P/N	Height Above PC Board in. (mm)	Footprint Dimensions in. (mm)	Mounting Configuration	Solderable Tab Options	Mounting Style	Thermal Performance at Typical Load	
						Natural Convection	Forced Load Convection
233-60AB	.600 (15.2)	.570 (14.5) x .500 (12.7)	Vert./Horiz.	No Tab	Clip/Mtg Hole	58°C @ 2W	11.0°C/W @ 400 LFM
233-60ABE-01	.600 (15.2)	.570 (14.5) x .500 (12.7)	Vertical	01	Clip/Mtg Hole	58°C @ 2W	11.0°C/W @ 400 LFM
233-60ABE-05	.500 (12.7)	.600 (15.2) x .570 (14.5)	Horizontal	05	Clip/Mtg Hole	58°C @ 2W	11.0°C/W @ 400 LFM
233-60ABE-10	.725 (18.4)	.570 (14.5) x .500 (12.7)	Vertical	10	Clip/Mtg Hole	58°C @ 2W	11.0°C/W @ 400 LFM
236-150AB	1.500 (38.1)	.570 (14.5) x .500 (12.7)	Vert./Horiz.	No Tab	Clip/Mtg Hole	40°C @ 2W	4.80°C/W @ 400 LFM
236-150ABE-01	1.500 (38.1)	.570 (14.5) x .500 (12.7)	Vertical	01	Clip/Mtg Hole	40°C @ 2W	4.80°C/W @ 400 LFM
236-150ABE-05	.500 (12.7)	1.500 (38.1) x .570 (14.5)	Horizontal	05	Clip/Mtg Hole	40°C @ 2W	4.80°C/W @ 400 LFM
236-150ABE-10	1.625 (41.3)	.570 (14.5) x .570 (12.7)	Vertical	10	Clip/Mtg Hole	40°C @ 2W	4.80°C/W @ 400 LFM

Material: Aluminum, Black Anodized

MECHANICAL DIMENSIONS 233 AND 236 SERIES

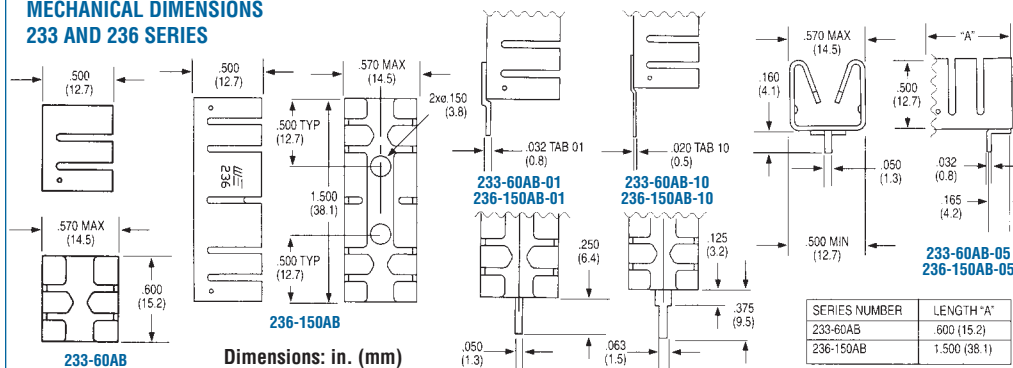

NATURAL AND FORCED CONVECTION CHARACTERISTICS

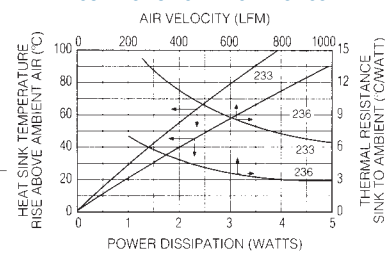

SUGGESTED TAB HOLE = 0.075 (1.9) (PLATED) WITH Ø 100 (2.5) PAD

275 & 231 SERIES

Compact, Stress-Free Labor-Saving Locking-Tab Heat Sinks

TO-220

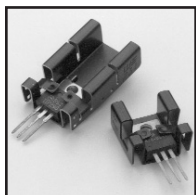

PATENT 5381041

Standard P/N	Height Above PC Board in. (mm)	Footprint Dimensions in. (mm)	Mounting Configuration	Solderable Tab Options	Mounting Style	Thermal Performance at Typical Load	
						Natural Convection	Forced Load Convection
275-75AB	.750 (19.1)	.835 (21.2) x .400 (12.7)	Vert./Horiz.	No Tab	Clip/Mtg Hole	44 C @ 2W	7.9°C/W @ 400 LFM
275-75ABE-01	.750 (19.1)	.835 (21.2) x .400 (12.7)	Vertical	01	Clip/Mtg Hole	44°C @ 2W	7.9°C/W @ 400 LFM
275-75ABE-10	.875 (12.7)	.835 (21.2) x .400 (14.5)	Vertical	10	Clip/Mtg Hole	44°C @ 2W	7.9°C/W @ 400 LFM
231-69PAB	.690 (18.4)	.835 (21.2) x .400 (12.7)	Vert./Horiz.	No Tab	Clip/Mtg Hole	45°C @ 2W	8°C/W @ 400 LFM
231-69PABE	.400 (10.1)	.690 (17.5) x .835 (12.7)	Horizontal	13H	Clip/Mtg Hole	45°C @ 2W	8°C/W @ 400 LFM
231-69PABE-XXX	.690 (17.5)	.835 (21.2) x .400 (12.7)	Vertical	13V, 14V, 15V	Clip/Mtg Hole	45°C @ 2W	8°C/W @ 400 LFM
231-75PAB	.750 (19.1)	.835 (21.2) x .400 (14.5)	Vert./Horiz.	No Tab	Clip/Mtg Hole	43°C @ 2W	7.9°C/W @ 400 LFM
231-75PABE	.400 (10.1)	.750 (19.1) x .835 (12.7)	Horizontal	13H	Clip/Mtg Hole	43°C @ 2W	7.9°C/W @ 400 LFM
231-75PABE-XXX	.750 (19.1)	.835 (21.2) x .400 (12.7)	Vertical	13V, 14V, 15V	Clip/Mtg Hole	43°C @ 2W	7.9°C/W @ 400 LFM
231-137PAB	1.375 (35)	.835 (21.2) x .400 (12.7)	Vert./Horiz.	No Tab	Clip/Mtg Hole	32°C @ 2W	5.9°C/W @ 400 LFM
231-137PABE	.400 (10.2)	1.375 (34.9) x .835 (12.7)	Horizontal	13H	Clip/Mtg Hole	32°C @ 2W	5.9°C/W @ 400 LFM
231-137PABE-XXX	1.375 (35)	.835 (21.2) x .400 (12.7)	Vertical	13V, 14V, 15V	Clip/Mtg Hole	32°C @ 2W	5.9°C/W @ 400 LFM

Material: Aluminum, Pre-anodized Black (PAB), Anodized Black (AB)

MECHANICAL DIMENSIONS

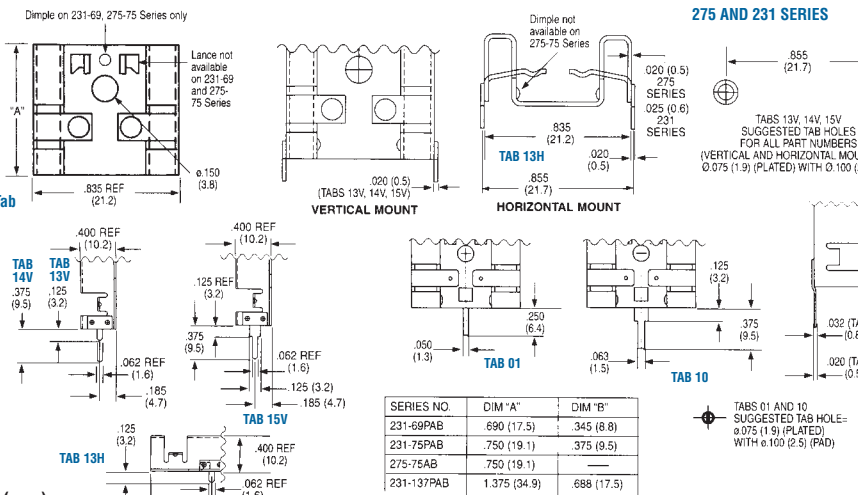

NATURAL AND FORCED CONVECTION CHARACTERISTICS

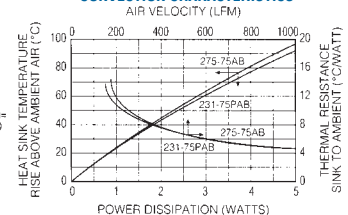

NATURAL AND FORCED CONVECTION CHARACTERISTICS

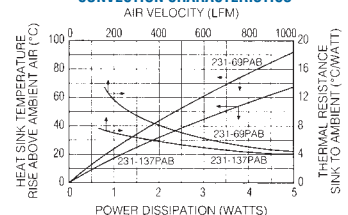

Dimensions: in. (mm)



BOARD LEVEL POWER SEMICONDUCTOR HEAT SINKS

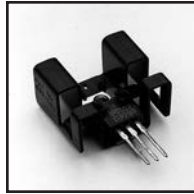

PATENT 5381041

235 SERIES

Compact, Stress-Free Labor-Saving Locking-Tab Heat Sinks

TO-220

Standard P/N	Height Above PC Board in. (mm)	Footprint Dimensions in. (mm)	Mounting Configuration	Solderable Tab Options	Mounting Style	Thermal Performance at Typical Load	
						Natural Convection	Forced Convection
235-85AB	.850 (21.6)	1.000 (25.4) x .500 (12.7)	Vert./Horiz.	No Tab	Clip/Mtg Hole	40°C @ 2W	6.8°C/W @ 400 LFM
235-85ABE-01	.850 (21.6)	1.000 (25.4) x .500 (12.7)	Vertical	01	Clip/Mtg Hole	40°C @ 2W	6.8°C/W @ 400 LFM
235-85ABE-05	.500 (12.7)	.850 (21.6) x 1.000 (25.4)	Horizontal	05	Clip/Mtg Hole	40°C @ 2W	6.8°C/W @ 400 LFM
235-85ABE-10	.975 (24.8)	1.000 (25.4) x .500 (12.7)	Vertical	10	Clip/Mtg Hole	40°C @ 2W	6.8°C/W @ 400 LFM

Material: Aluminum, Black Anodized

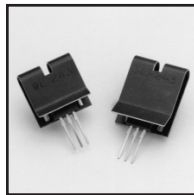
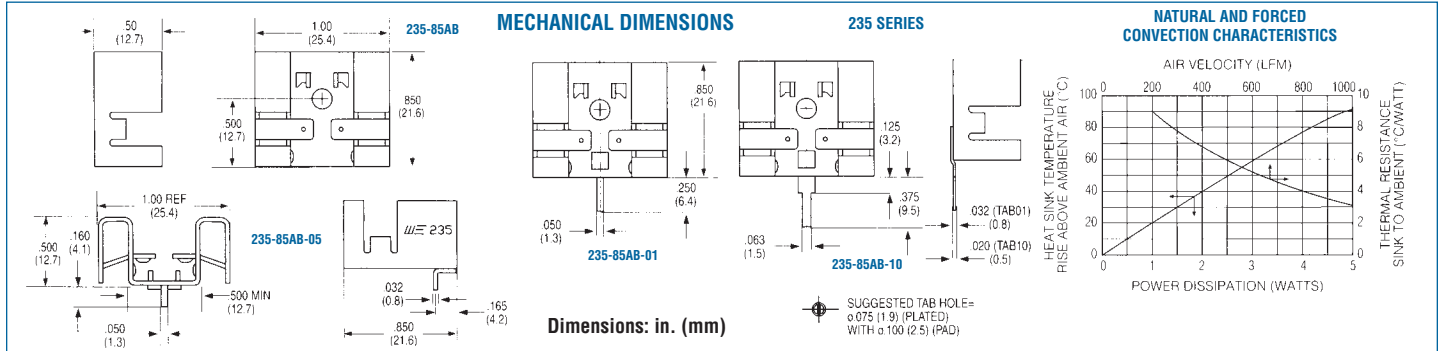

243 SERIES

Labor-Saving Clip-On Heat Sinks

TO-220

Standard P/N	Height Above PC Board in. (mm)	Footprint Dimensions in. (mm)	Mounting Configuration	Solderable Tab Options	Mounting Style	Thermal Performance at Typical Load	
						Natural Convection	Forced Convection
243-1PAB	1.000 (25.4)	.800 (20.3) x .270 (6.9)	Vert./Horiz.	No Tab	Clip	50°C @ 2W	4.5°C/W @ 400 LFM
243-3PAB	.800 (20.3)	.800 (20.3) x .270 (6.9)	Vert./Horiz.	No Tab	Clip	78°C @ 2W	8.2°C/W @ 400 LFM

Material: Aluminum, Pre-anodized Black

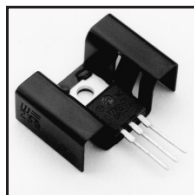
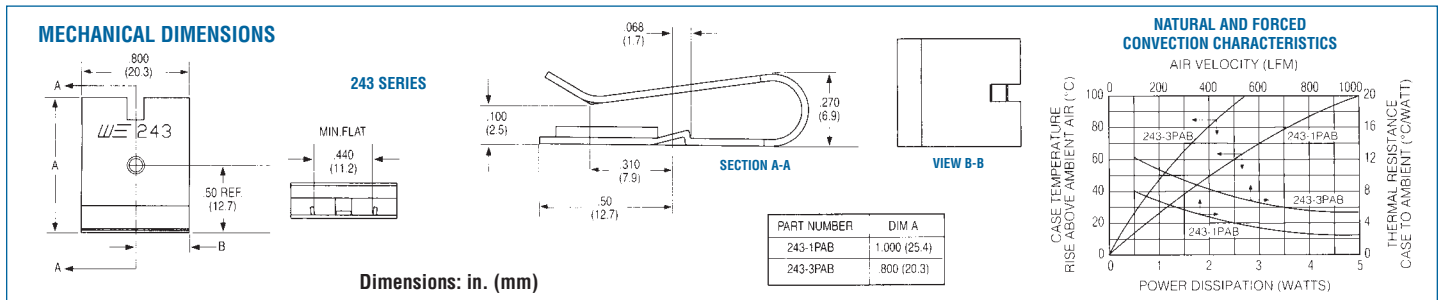

PATENT PENDING

239 SERIES

Snap-Down Self-Locking Heat Sinks

TO-220

Standard P/N	Height Above PC Board in. (mm)	Footprint Dimensions in. (mm)	Mounting Configuration	Solderable Tab Options	Mounting Style	Thermal Performance at Typical Load	
						Natural Convection	Forced Convection
239-75AB	.750 (19.1)	1.120 (28.4) x .435 (11.0)	Vert./Horiz	No Tab	Clip/Mtg Hole	38°C @ 2W	6°C/W @ 400 LFM
239-75ABE-03	.750 (19.1)	1.120 (28.4) x .435 (11.0)	Vertical	03	Clip/Mtg Hole	38°C @ 2W	6°C/W @ 400 LFM
239-75ABE-04	.750 (19.1)	1.120 (28.4) x .435 (11.0)	Vertical	04	Clip/Mtg Hole	38°C @ 2W	6°C/W @ 400 LFM

Material: Aluminum, Black Anodized

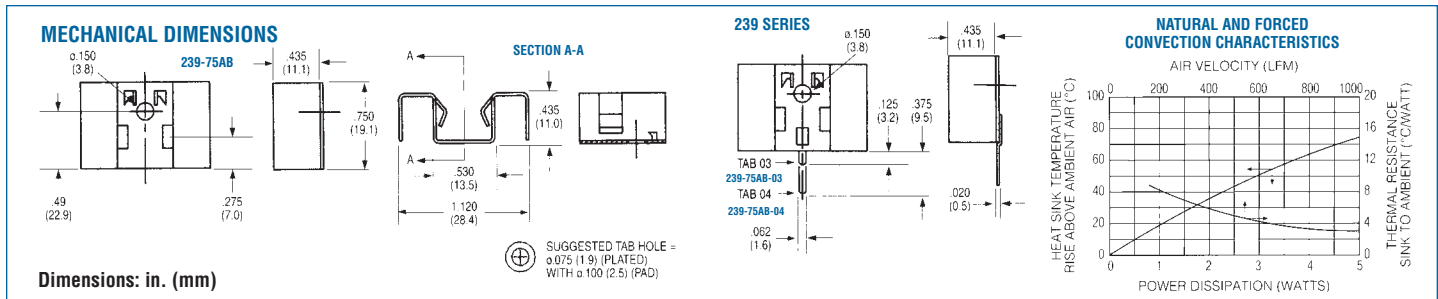

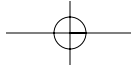

**Board Level
Heat Sinks**



BOARD LEVEL POWER SEMICONDUCTOR HEAT SINKS

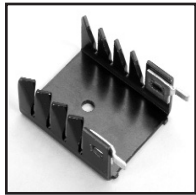

265 SERIES

Vertical Mount Heat Sink

TO-220

Standard P/N	Height Above PC Board in. (mm)	Maximum Footprint in. (mm)	Thermal Performance at Typical Load	
			Natural Convection	Forced Convection
265-118ABHE-22	1.18 (30.0)	1.00 (25.4) x .50 (12.7)	56°C rise @ 4W	7.0°C/W @ 200LFM

Material: Aluminum, Black Anodized

MECHANICAL DIMENSIONS

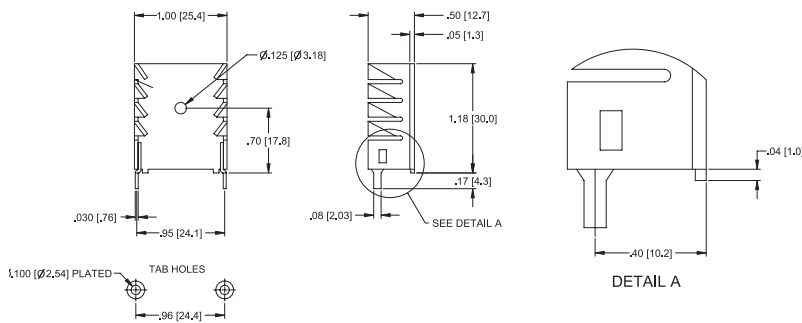

NATURAL AND FORCED CONVECTION CHARACTERISTICS

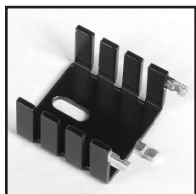
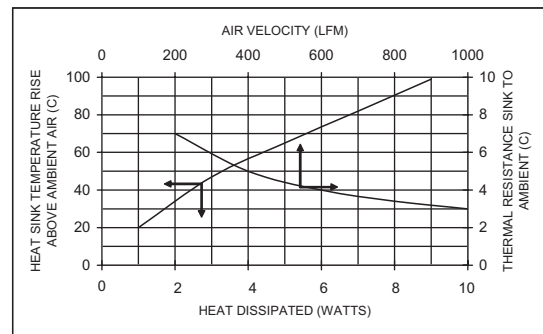

286DB SERIES

Vertical Mount Heat Sink

TO-220

Standard P/N	Height Above PC Board in. (mm)	Maximum Footprint in. (mm)	Thermal Performance at Typical Load	
			Natural Convection	Forced Convection
286DBE	.95 (24.1)	1.00 (25.4) x .50 (12.7)	65°C rise @ 4W	9.0°C/W @ 200LFM

Material: Aluminum, Black Anodized

MECHANICAL DIMENSIONS

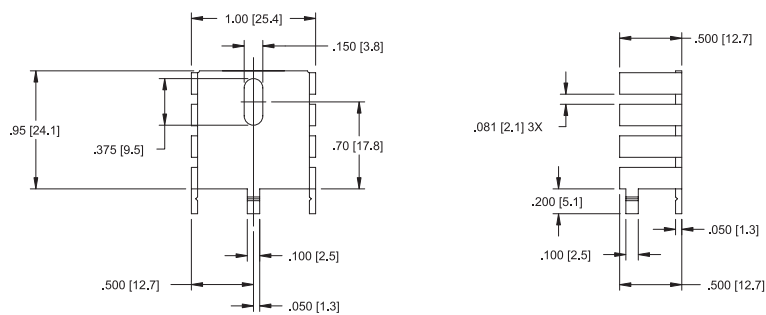

NATURAL AND FORCED CONVECTION CHARACTERISTICS

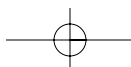
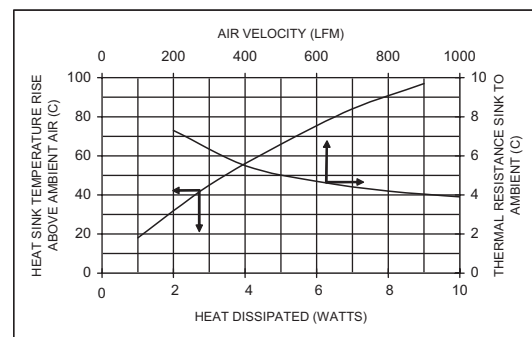



BOARD LEVEL POWER SEMICONDUCTOR HEAT SINKS

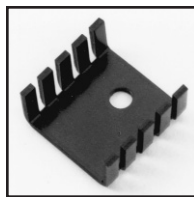

273 SERIES Low-Cost, Low-Height Wavesolderable Heat Sinks

TO-218, TO-220

Standard P/N	Height Above PC Board in. (mm)	Footprint Dimensions in. (mm)	Mounting Configuration	Solderable Tab Options	Mounting Style	Thermal Performance at Typical Load	
						Natural Convection	Forced Convection
273-AB	.375 (9.5)	.750 (19.1) x .750 (19.1)	Vert./Horiz.	No Tab	Mtg Hole	49°C @ 2W	7.2°C/W @ 400 LFM
273-ABE-01	.375 (9.5)	.750 (19.1) x .750 (19.1)	Vertical	01	Mtg Hole	49°C @ 2W	7.2°C/W @ 400 LFM
273-ABE-02	.375 (9.5)	.750 (19.1) x .750 (19.1)	Vertical	02	Mtg Hole	49°C @ 2W	7.2°C/W @ 400 LFM

Material: Aluminum, Black Anodized

MECHANICAL DIMENSIONS

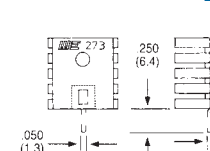
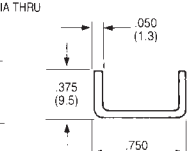
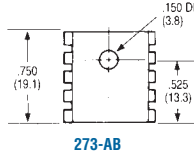

273 SERIES

Dimensions: in. (mm)

Note:
1. Suggested Tab Hole = ϕ 0.075 (1.9) (Plated) with ϕ 0.100 (2.5) pad

NATURAL AND FORCED CONVECTION CHARACTERISTICS

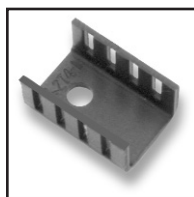
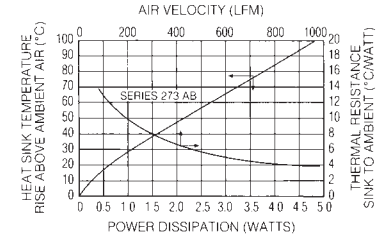

274 & 281 SERIES Low-Cost, Low-Height Wavesolderable Heat Sinks

TO-220

Standard P/N	Height Above PC Board in. (mm)	Footprint Dimensions in. (mm)	Mounting Configuration	Solderable Tab Options	Mounting Style	Thermal Performance at Typical Load	
						Natural Convection	Forced Convection
274-1AB	.375 (9.5)	.520 (13.2) x .750 (19.1)	Vert./Horiz.	No Tab	Mtg Hole	56°C @ 2W	8.0°C/W @ 400 LFM
274-1ABE-01	.375 (9.5)	.520 (13.2) x .750 (19.1)	Vertical	01	Mtg Hole	56°C @ 2W	8.0°C/W @ 400 LFM
274-1ABE-02	.375 (9.5)	.520 (13.2) x .750 (19.1)	Vertical	02	Mtg Hole	56°C @ 2W	8.0°C/W @ 400 LFM
274-2AB	.500 (12.7)	.520 (13.2) x .750 (19.1)	Vert./Horiz.	No Tab	Mtg Hole	50°C @ 2W	7.0°C/W @ 400 LFM
274-2ABE-01	.500 (12.7)	.520 (13.2) x .750 (19.1)	Vertical	01	Mtg Hole	50°C @ 2W	7.0°C/W @ 400 LFM
274-2ABE-02	.500 (12.7)	.520 (13.2) x .750 (19.1)	Vertical	02	Mtg Hole	50°C @ 2W	7.0°C/W @ 400 LFM
274-3AB	.250 (6.4)	.520 (13.2) x .750 (19.1)	Vert./Horiz.	No Tab	Mtg Hole	62°C @ 2W	9.0°C/W @ 400 LFM
274-3ABE-01	.250 (6.4)	.520 (13.2) x .750 (19.1)	Vertical	01	Mtg Hole	62°C @ 2W	9.0°C/W @ 400 LFM
274-3ABE-02	.250 (6.4)	.520 (13.2) x .750 (19.1)	Vertical	02	Mtg Hole	62°C @ 2W	9.0°C/W @ 400 LFM
281-1AB	.375 (9.5)	.520 (13.2) x .750 (19.1)	Vertical	No Tab	Mtg Hole	56°C @ 2W	8.0°C/W @ 400 LFM
281-2AB	.500 (12.7)	.520 (13.2) x .750 (19.1)	Vertical	No Tab	Mtg Hole	50°C @ 2W	7.0°C/W @ 400 LFM

Material: Aluminum, Black Anodized

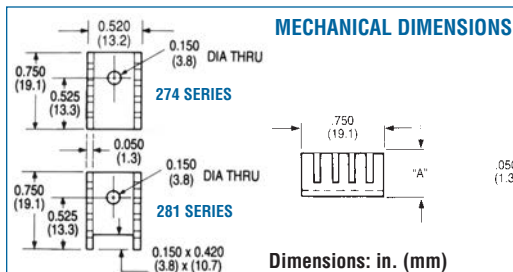

274 SERIES

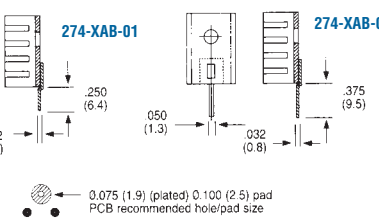

Dimensions: in. (mm)

0.075 (1.9) (plated) 0.100 (2.5) pad
PCB recommended hole/pad size

NATURAL AND FORCED CONVECTION CHARACTERISTICS

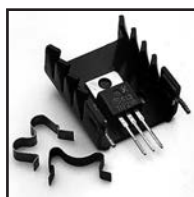
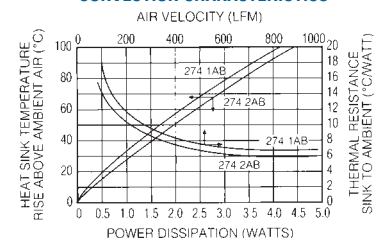

240 SERIES Labor-Saving Twisted Fin Heat Sinks

TO-220

Standard P/N	Height Above PC Board in. (mm)	Footprint Dimensions in. (mm)	Mounting Configuration	Solderable Tab Options	Mounting Style	Thermal Performance at Typical Load	
						Natural Convection	Forced Convection
240-118ABEH-22	1.180 (30.0)	1.000 (25.4) x .500 (12.7)	Vertical	22	Clip/Mtg Hole	55°C @ 4W	5.3°C/W @ 400 LFM
240-118ABES-22	1.180 (30.0)	1.000 (25.4) x .500 (12.7)	Vertical	22	Clip/Mtg Slot	55°C @ 4W	5.3°C/W @ 400 LFM

Material: Aluminum, Black Anodized

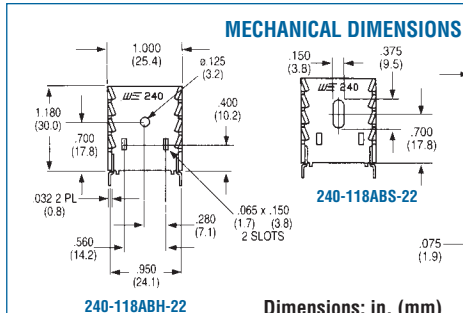

240 SERIES

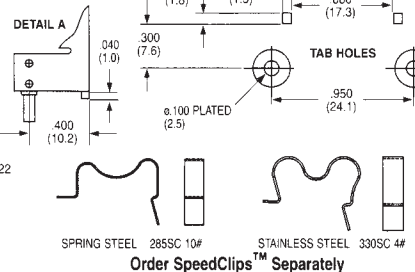

Dimensions: in. (mm)

Order SpeedClips™ Separately

NATURAL AND FORCED CONVECTION CHARACTERISTICS

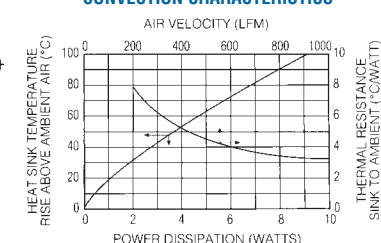

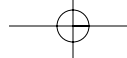

Board Level Heat Sinks



BOARD LEVEL POWER SEMICONDUCTOR HEAT SINKS

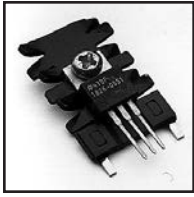

242 SERIES Low-Height, Low-Profile Twisted Fin Heat Sinks

TO-220

Standard P/N	Height Above PC Board in. (mm)	Footprint Dimensions in. (mm)	Mounting Configuration	Solderable Tab Options	Mounting Style	Thermal Performance at Typical Load	
						Natural Convection	Forced Convection
242-125ABE-22	1.285 (32.6)	.875 (22.2) x .250 (6.4)	Vertical	22	Mtg Hole	48°C @ 2W	6.2°C/W @ 400 LFM

Material: Aluminum, Black Anodized

242-125AB-22

MECHANICAL DIMENSIONS

Dimensions: in. (mm)

242 SERIES

TAB HOLES

NATURAL AND FORCED CONVECTION CHARACTERISTICS



232 & 238 SERIES Staggered Fin Heat Sinks for Vertical Mounting

TO-202, TO-220

Standard P/N	Height Above PC Board in. (mm)	Footprint Dimensions in. (mm)	Mounting Configuration	Solderable Tab Options	Mounting Style	Thermal Performance at Typical Load	
						Natural Convection	Forced Convection
232-200AB	2.000 (50.8)	1.380 (35.1) x .500 (12.7)	Vertical	2, Twisted	Clip/Mtg Hole	48°C @ 4W	3.3°C/W @ 400 LFM
232-200ABE-23	2.000 (50.8)	1.380 (35.1) x .500 (12.7)	Vertical	2, Solderable	Clip/Mtg Hole	48°C @ 4W	3.3°C/W @ 400 LFM
238-200AB	2.000 (50.8)	1.380 (35.1) x .500 (12.7)	Vertical	2, Twisted	Mtg Slot	48°C @ 4W	3.3°C/W @ 400 LFM
238-200ABE-23	2.000 (50.8)	1.380 (35.1) x .500 (12.7)	Vertical	2, Solderable	Mtg Slot	48°C @ 4W	3.3°C/W @ 400 LFM

Material: Aluminum, Black Anodized

MECHANICAL DIMENSIONS

232-200AB-23

238-200AB

NATURAL AND FORCED CONVECTION CHARACTERISTICS

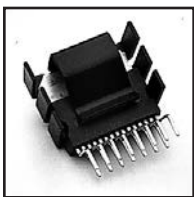

251 SERIES Slim-Profile Heat Sinks With Integral Clips

15 Lead Multiwatt

Standard P/N	Height Above PC Board in. (mm)	Footprint Dimensions in. (mm)	Mounting Configuration	Solderable Tab Options	Mounting Style	Thermal Performance at Typical Load	
						Natural Convection	Forced Convection
251-62AB	.620 (15.7)	.910 (23.1) x .380 (9.7)	Vert./Horiz.	No Tab	Clip	66°C @ 3W	66°C/W @ 400 LFM
251-80AB	.845 (21.5)	.910 (23.1) x .380 (9.7)	Vert./Horiz.	No Tab	Clip	64°C @ 3W	66°C/W @ 400 LFM
251-80ABE-19	.875 (22.2)	.910 (23.1) x .380 (9.7)	Vertical	19	Clip	64°C @ 3W	66°C/W @ 400 LFM

Material: Aluminum, Black Anodized

MECHANICAL DIMENSIONS

251-80AB

251-80AB-19

NATURAL AND FORCED CONVECTION CHARACTERISTICS

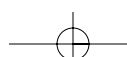



BOARD LEVEL HEAT SINKS FOR TO-220, TO-218 AND MULTIWATT™ COMPONENTS

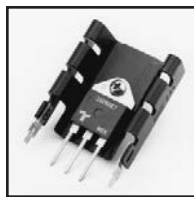

244 SERIES

Low Height, Slim Profile Wavesolderable Folded Fin Heat Sinks

MULTIWATT

Standard P/N	Height Above PC Board in. (mm)	Footprint Dimensions in. (mm)	Mounting Configuration	Solderable Tab Options	Thermal Performance at Typical Load		Weight lbs. (grams)
					Natural Convection	Forced Convection	
244-145AB	1.450 (36.8)	1.300 (33.0) x 480 (12.1)	Vert./Horiz.	No Tab	44°C @ 4W	4.4°C/W @ 400 LFM	.0160 (7.25)
244-145ABE-50	1.650 (41.9)	1.300 (33.0) x 480 (12.1)	Vertical	50	44°C @ 4W	4.4°C/W @ 400 LFM	.0170 (7.20)

Material: Aluminum, Black Anodized

MECHANICAL DIMENSIONS

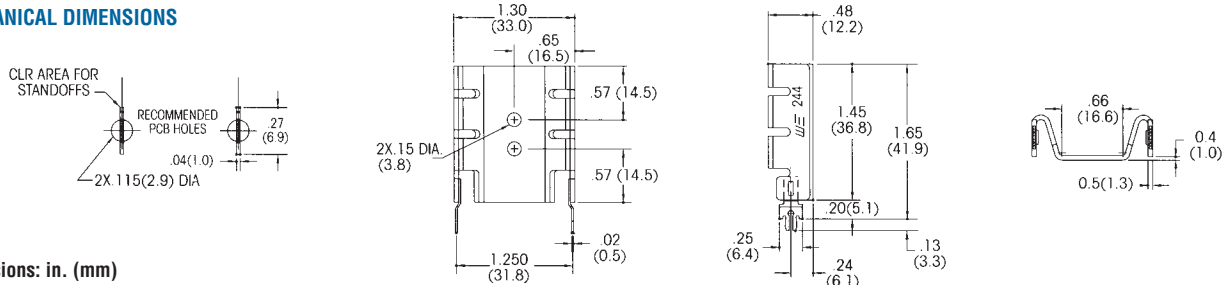

Dimensions: in. (mm)



245 SERIES

Low Height, Slim Profile Wavesolderable Folded Fin Heat Sinks

MULTIWATT

Standard P/N	Height Above PC Board in. (mm)	Footprint Dimensions in. (mm)	Mounting Configuration	Solderable Tab Options	Thermal Performance at Typical Load		Weight lbs. (grams)
					Natural Convection	Forced Convection	
245-145AB	1.450 (36.8)	1.750 (44.5) x .380 (9.7)	Vert./Horiz.	No Tab	38°C @ 4W	3.2°C/W @ 400 LFM	.0160 (7.25)
245-145ABE-50	1.650 (41.9)	1.750 (44.5) x .380 (9.7)	Vertical	50	38°C @ 4W	3.2°C/W @ 400 LFM	.0170 (7.20)

Material: Aluminum, Black Anodized

MECHANICAL DIMENSIONS

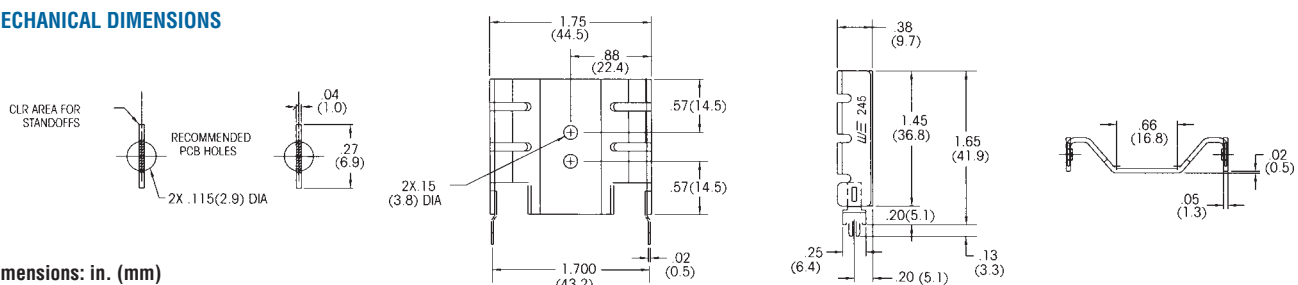

Dimensions: in. (mm)



246 SERIES

Medium Height, Slim Profile Wavesolderable Folded Fin Heat Sinks

MULTIWATT

Standard P/N	Height Above PC Board in. (mm)	Footprint Dimensions in. (mm)	Mounting Configuration	Solderable Tab Options	Thermal Performance at Typical Load		Weight lbs. (grams)
					Natural Convection	Forced Convection	
246-197AB	1.968 (50.0)	1.986 (50.4) x 3.75 (9.5)	Vert./Horiz.	No Tab	35°C @ 4W	2.8°C/W @ 400 LFM	.0240 (10.90)
246-197ABE-50	2.168 (55.1)	1.986 (50.4) x 3.75 (9.5)	Vertical	50	35°C @ 4W	2.8°C/W @ 400 LFM	.0250 (11.40)

Order SpeedClip™ 285SC or 330SC separately. (See 248 Series section).

Material: Aluminum, Black Anodized

MECHANICAL DIMENSIONS

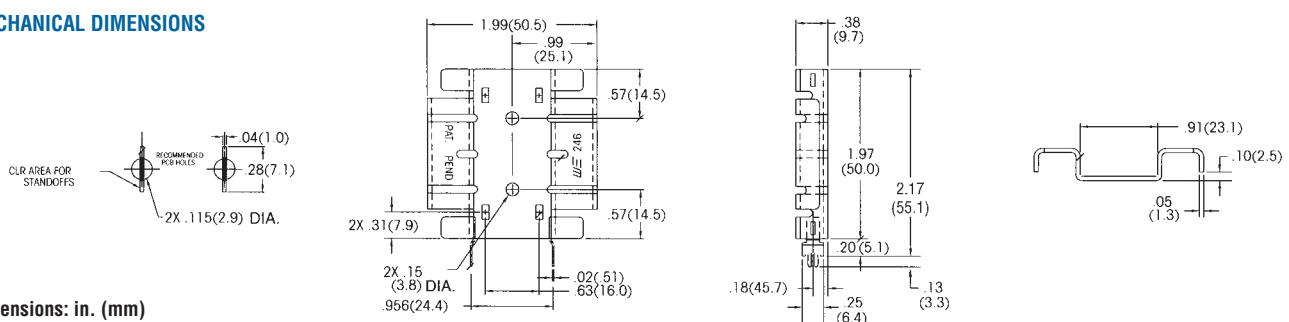

Dimensions: in. (mm)

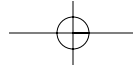

Board Level Heat Sinks



BOARD LEVEL HEAT SINKS FOR TO-220, TO-218 AND MULTIWATT™ COMPONENTS

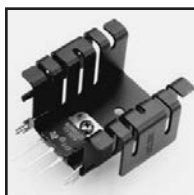

247 SERIES		<i>Medium Height, Deep Profile Wavesolderable Folded Fin Heat Sinks</i>					MULTIWATT	
Standard P/N	Height Above PC Board in. (mm)	Footprint Dimensions in. (mm)	Mounting Configuration	Solderable Tab Options	Thermal Performance at Typical Load Natural Convection	Thermal Performance at Typical Load Forced Convection	Weight lbs. (grams)	
247-195AB	1.950 (49.5)	1.900 (48.3) x .950 (24.1)	Vert./Horiz.	No Tab	25°C@ 4W	2.4°C/W @ 400 LFM	.0330 (15.10)	
247-195ABE-50	1.950 (49.5)	1.900 (48.3) x .950 (24.1)	Vertical	50	25°C@ 4W	2.4°C/W @ 400 LFM	.0340 (15.60)	

Order SpeedClip™ 285SC or 330SC separately. (See 248 Series section).
Material: Aluminum, Black Anodized

MECHANICAL DIMENSIONS

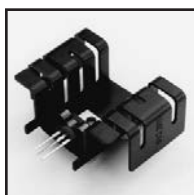
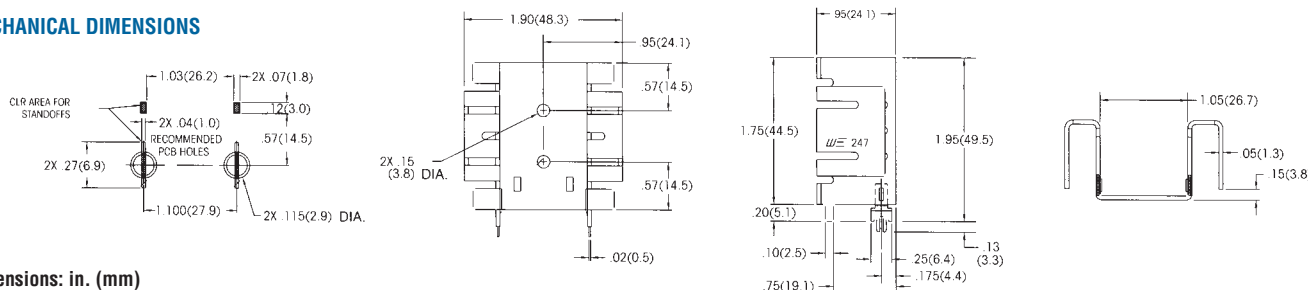

248 SERIES		<i>Low Height, Medium Profile Wavesolderable Folded Fin Heat Sinks</i>					MULTIWATT	
Standard P/N	Height Above PC Board in. (mm)	Footprint Dimensions in. (mm)	Mounting Configuration	Solderable Tab Options	Thermal Performance at Typical Load Natural Convection	Thermal Performance at Typical Load Forced Convection	Weight lbs. (grams)	
248-162AB	1.620 (41.1)	2.000 (50.8) x .750 (19.1)	Vert./Horiz.	No Tab	35°C @ 4W	2.5°C/W @ 400 LFM	.026 (11.60)	
248-162ABE-50	1.620 (41.1)	2.000 (50.8) x .750 (19.1)	Vertical	50	35°C @ 4W	2.5°C/W @ 400 LFM	.027 (12.20)	

Order SpeedClip™ 285SC or 330SC separately.
Material: Aluminum, Black Anodized

MECHANICAL DIMENSIONS

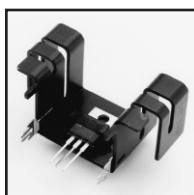
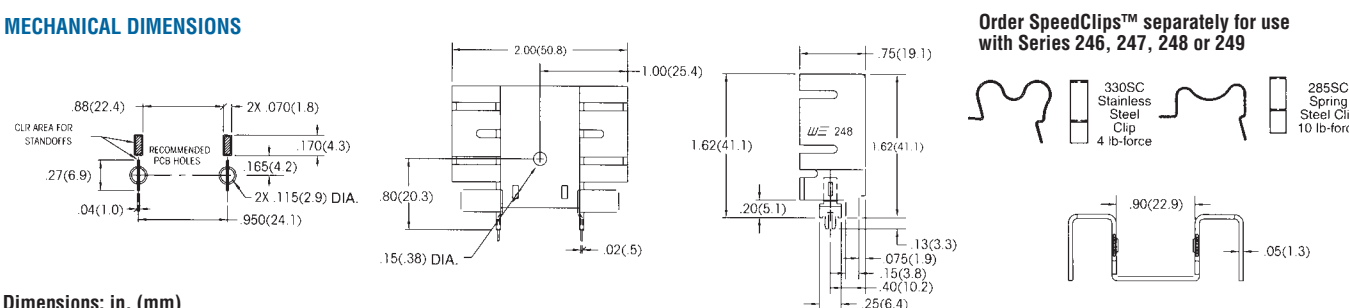

249 SERIES		<i>Medium Height, Deep Profile Wavesolderable Folded Fin Heat Sinks</i>					MULTIWATT	
Standard P/N	Height Above PC Board in. (mm)	Footprint Dimensions in. (mm)	Mounting Configuration	Solderable Tab Options	Thermal Performance at Typical Load Natural Convection	Thermal Performance at Typical Load Forced Convection	Weight lbs. (grams)	
249-113AB	1.130 (28.7)	1.900 (48.3) x .950 (24.1)	Vert./Horiz.	No Tab	35°C@ 4W	3.29°C/W @ 400 LFM	.020 (8.90)	
249-113ABE-50	1.130 (28.7)	1.900 (48.3) x .950 (24.1)	Vertical	50	35°C@ 4W	3.29°C/W @ 400 LFM	.021 (9.40)	

Order SpeedClip™ 285SC or 330SC separately. (See 248 Series section).
Material: Aluminum, Black Anodized

MECHANICAL DIMENSIONS

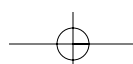
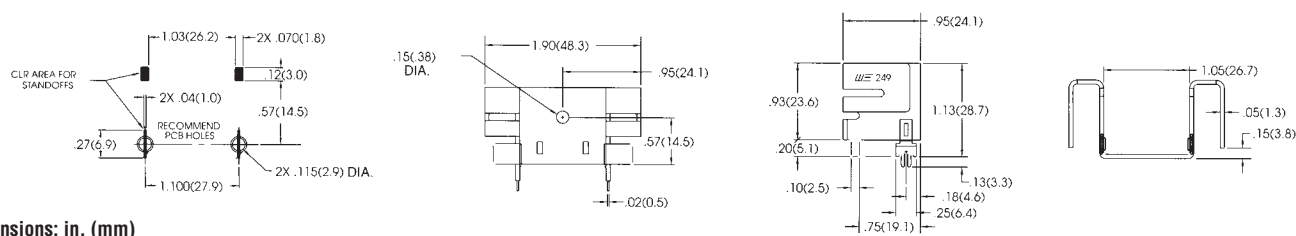



BOARD LEVEL POWER SEMICONDUCTOR HEAT SINKS

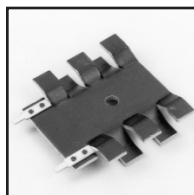

288 SERIES

Compact Wave-Solderable Low-Cost Heat Sinks

TO-220, TO-202

Standard P/N	Height Above PC Board in. (mm)	Maximum Footprint in. (mm)	Thermal Performance at Typical Load		Weight lbs. (grams)
			Natural Convection	Forced Convection	
288-1ABE	1.250 (31.8)	0.875 (22.2) x 0.215 (5.5)	85°C @ 4W	12°C/W @ 200 LFM	0.0057 (2.59)

Mounting tabs are pre-tinned to ensure excellent wave-solder bond and good electrical connections for vertical mounting of TO-220 and TO-202 semiconductor packages. These heat sinks are designed for use where minimum PC board

space is available. The 288-1AB is a stamped aluminum heat sink, black anodized, designed for applications requiring good heat dissipation from a heat sink occupying minimum space, available at minimum cost.

MECHANICAL DIMENSIONS

288 SERIES

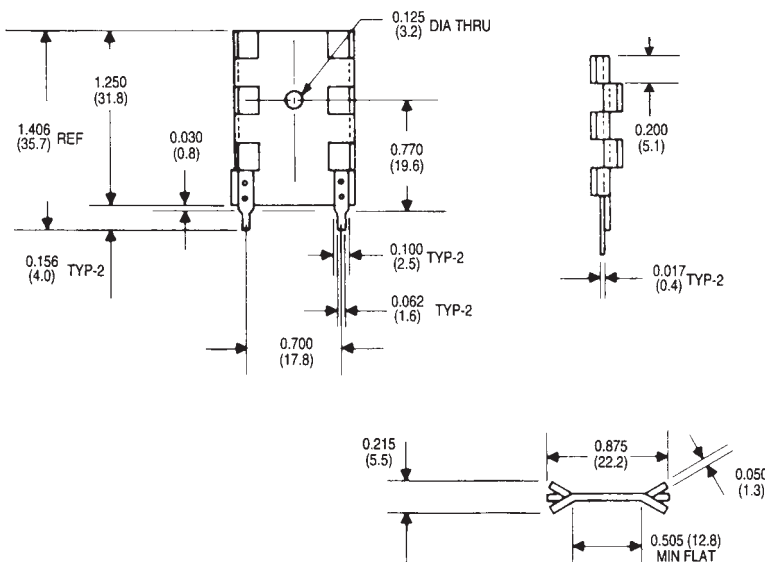

Dimensions: in. (mm)

NATURAL AND FORCED CONVECTION CHARACTERISTICS

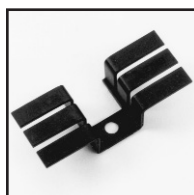
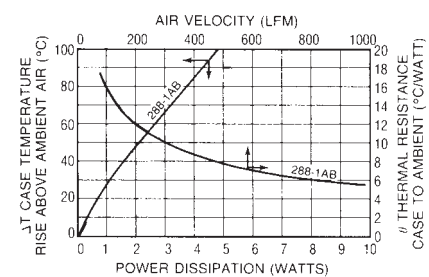

271 SERIES

Top-Mount Booster Heat Sinks for Use with 270/272/280 Series

TO-220

Standard P/N	Height Above Semiconductor Case in. (mm)	Horizontal Mounting Footprint Dimensions in. (mm)	Thermal Performance at Typical Load		Weight lbs. (grams)
			Natural Convection	Forced Convection	
271-AB	0.500 (12.7)	1.750 (44.5) x 0.700 (17.8)	62°C @ 4W (NOTE A) 31 °C @ 4W (NOTE B)	5.1°C/W @ 400 LFM 1.8°C/W 400 LFM (NOTE B)	0.0052 (2.36)

Material: Aluminum, Black Anodized

This top-hat style booster heat sink can be added to any of the 270, 272, or 280 Series for improved performance.

NOTE A: Thermal resistance with one 271-AB. NOTE B: Thermal resistance (total) as shown with (2) 271-AB types added to (1) 272-AB type.

MECHANICAL DIMENSIONS

271 SERIES

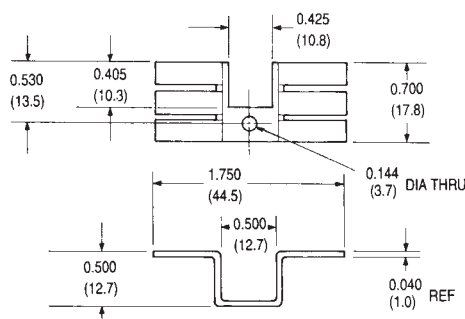

Dimensions: in. (mm)

NATURAL AND FORCED CONVECTION CHARACTERISTICS

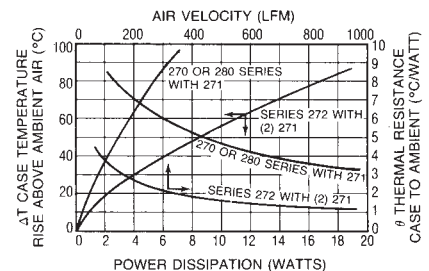



Board Level Heat Sinks



BOARD LEVEL POWER SEMICONDUCTOR HEAT SINKS

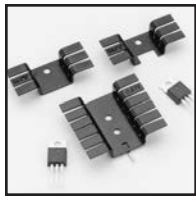

270/272/280 SERIES

Small Footprint Low-Cost Heat Sinks

TO-220, TO-202

Standard P/N	Height Above PC Board in. (mm)	Horizontal Mounting Maximum Footing in. (mm)	Solderable Tab Options	Thermal Performance at Typical Load		Weight lbs. (grams)
				Natural Convection	Forced Convection	
270-AB	0.375 (9.4)	1.750 (44.5) x 0.700 (17.8)	—	70°C @ 4W	6.0°C/W @ 400 LFM	0.0052 (2.36)
272-AB	0.375 (9.4)	1.750 (44.5) x 1.450 (36.8)	01,02	42°C @ 4W	3.6°C/W @ 400 LFM	0.0105 (5.72)
280-AB	0.375 (9.4)	1.750 (44.5) x 0.700 (17.8)	—	70°C @ 4W	6.0°C/W @ 400 LFM	0.0048 (2.18)

Material: Aluminum, Black Anodized

These exceptionally low-cost heat sinks can be mounted horizontally under a TO-220 or TO-202 case style with a maximum height of only 0.375 in. (9.4). For added performance, a 271 Series heat sink can also be used for double-sided heat dissipation.

The 270-AB and 280-AB accept one power semiconductor; the 272-AB is designed for two power semiconductors. Specify solderable tab options for the 272 Series by the addition of suffix "01" or "02" to the standard part number (i.e. 272-AB01 or 272-AB02).

MECHANICAL DIMENSIONS

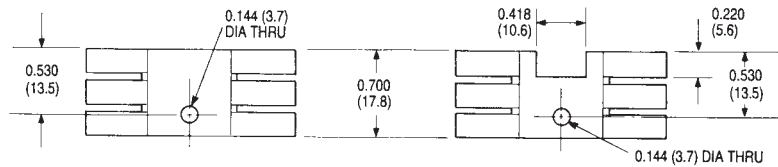

270 SERIES

280 SERIES

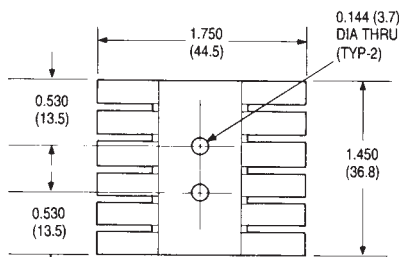

272 SERIES

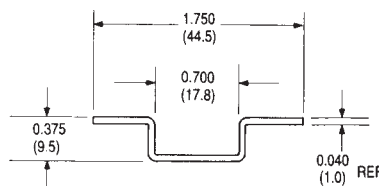

NATURAL AND FORCED CONVECTION CHARACTERISTICS

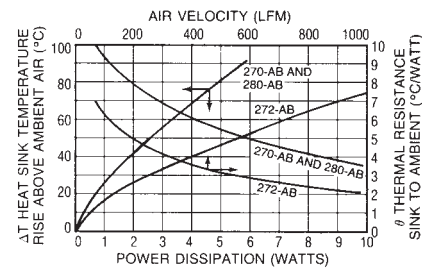

Dimensions: in. (mm)

Note: 1. Suggested Tab Hole = 0.075 ±0.003 plated with 0.100 pad

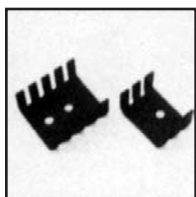

289 & 290 SERIES

Low-Cost Single or Dual Package Heat Sinks

TO-218, TO-202, TO-220

Standard P/N	Height Above PC Board in. (mm)	Horizontal Mounting Maximum Footing in. (mm)	Thermal Performance at Typical Load		Weight lbs. (grams)
			Natural Convection	Forced Convection	
289-AB	0.500 (12.7)	1.000 (25.4) x 0.710 (18.1)	50°C @ 2W	9.0 C/W @ 400 LFM	0.0055 (2.49)
289-AP	0.500 (12.7)	1.000 (25.4) x 0.710 (18.1)	50°C @ 2W	9.0 C/W @ 400 LFM	0.0055 (2.49)
290-1AB	0.500 (12.7)	1.000 (25.4) x 1.180 (30.0)	44°C @ 2W	7.0 C/W @ 400 LFM	0.0082 (3.72)
290-2AB	0.500 (12.7)	1.000 (25.4) x 1.180 (30.0)	44°C @ 2W	7.0 C/W @ 400 LFM	0.0081 (3.67)

Material: Aluminum, Black Anodized

Low in cost and compact in overall dimensions, one 289 Series heat sink can accommodate one semiconductor; the 289 Series is available with a black an-

odized finish (289-AB) or with no finish (289-AP). Two semiconductors can be mounted to the 290-2AB style.

289 SERIES

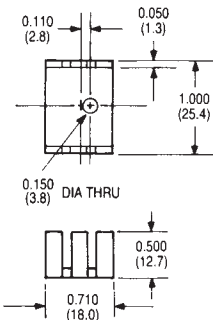

MECHANICAL DIMENSIONS

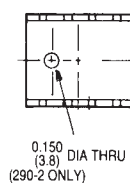

290 SERIES

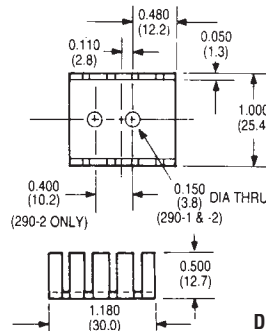

Dimensions: in. (mm)

NATURAL AND FORCED CONVECTION CHARACTERISTICS

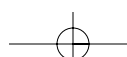
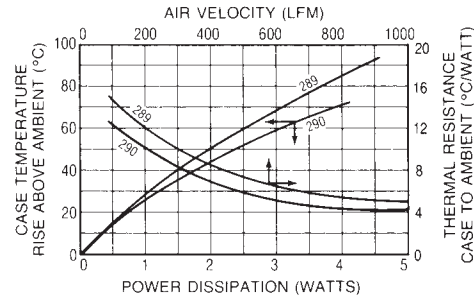



BOARD LEVEL POWER SEMICONDUCTOR HEAT SINKS

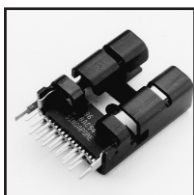

250 SERIES

High-Performance Slim Profile Heat Sinks With Integral Clips

MULTIWATT

Standard P/N	Height Above PC Board in. (mm)	Footprint Dimensions in. (mm)	Mounting Configuration	Solderable Tab Options	Mounting Style	Thermal Performance at Typical Load	
						Natural Convection	Forced Convection
250-122AB	1.220 (31.0)	1.000 (25.4) x .500 (12.7)	Vert./Horiz.	No Tab	Clip	50°C @ 4W	3.7°C/W @ 400 LFM
250-122ABE-09	1.220 (31.0)	1.000 (25.4) x .500 (12.7)	Vertical	09	Clip	50°C @ 4W	3.7°C/W @ 400 LFM
250-122ABE-25	1.380 (35.1)	1.000 (25.4) x .500 (12.7)	Vertical	25	Clip	50°C @ 4W	3.7°C/W @ 400 LFM

Material: Aluminum, Black Anodized

MECHANICAL DIMENSIONS

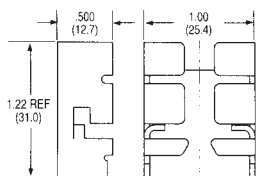

250-122AB
Dimensions: in. (mm)

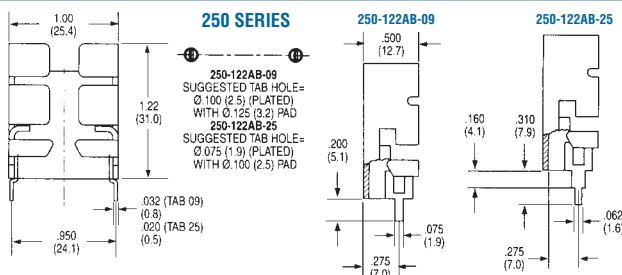

NATURAL AND FORCED CONVECTION CHARACTERISTICS

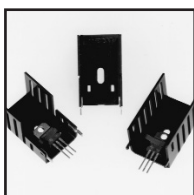
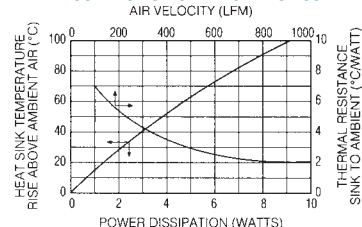

237 & 252 SERIES

High-Performance, High-Power Vertical Mount Heat Sinks

TO-220

Standard P/N	Height Above PC Board in. (mm)	Footprint Dimensions in. (mm)	Mounting Configuration	Solderable Tab Options	Mounting Style	Thermal Performance at Typical Load	
						Natural Convection	Forced Convection
237-167AB2	1.675 (42.5)	1.000 (25.4) x 1.000 (25.4)	Vertical	2, Twisted	Clip/Mtg Slot	46°C @ 4W	4.5°C/W @ 200 LFM
237-167AB3	1.675 (42.5)	1.000 (25.4) x 1.000 (25.4)	Vertical	3, Twisted	Clip/Mtg Slot	46°C @ 4W	4.5°C/W @ 200 LFM
237-167ABE2-24	1.675 (42.5)	1.000 (25.4) x 1.000 (25.4)	Vertical	2, Solderable	Clip/Mtg Slot	46°C @ 4W	4.5°C/W @ 200 LFM
252-167AB2	1.675 (42.5)	1.000 (25.4) x 1.000 (25.4)	Vertical	2, Twisted	Clip/Mtg Slot	40°C @ 4W	4.5°C/W @ 200 LFM
252-167AB3	1.675 (42.5)	1.000 (25.4) x 1.000 (25.4)	Vertical	3, Twisted	Clip/Mtg Slot	40°C @ 4W	4.5°C/W @ 200 LFM
252-167ABE2-24	1.675 (42.5)	1.000 (25.4) x 1.000 (25.4)	Vertical	2, Solderable	Clip/Mtg Slot	40°C @ 4W	4.5°C/W @ 200 LFM

Order SpeedClips™ 285SC or 330SC separately for rapid component installation, lowering manufacturing costs. Material: Aluminum, Black Anodized

MECHANICAL DIMENSIONS

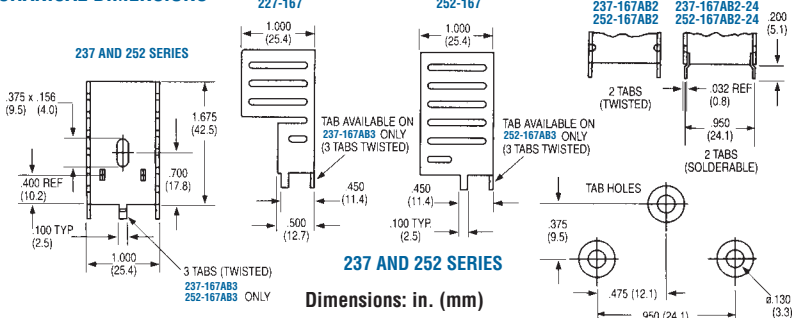

237 AND 252 SERIES
Dimensions: in. (mm)

NATURAL AND FORCED CONVECTION CHARACTERISTICS

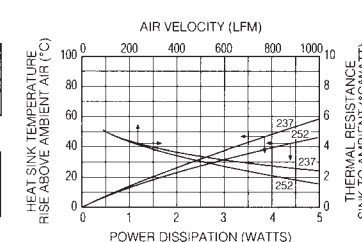

291 SERIES

Labor-Saving Clip-on Heat Sinks

TO-220

Standard P/N	Height Above PC Board in. (mm)	Mounting Footprint Dimensions in. (mm)	Mounting Style	Thermal Performance at Typical Load		Weight lbs. (grams)
				Natural Convection	Forced Convection	
291-C236AB	0.860 (21.9)	1.100 (27.0) x 0.360 (9.1)	TO-220 (Clip)	80°C @ 2W	24°C/W @ 600 LFM	0.0026 (1.18)
291-H36AB	0.860 (21.9)	1.100 (27.0) x 0.360 (9.1)	TO-220 (Mtg. Hole)	68°C @ 2W	16°C/W @ 600 LFM	0.0026 (1.18)

Material: Aluminum, Black Anodized

Designed for mounting horizontally or vertically on a circuit board, 291 Series heat sinks employ a unique clip for attachment of TO-220 case styles.

One type is available with a locking clip and one with a 0.140 in. (3.6) diameter mounting hole only.

MECHANICAL DIMENSIONS

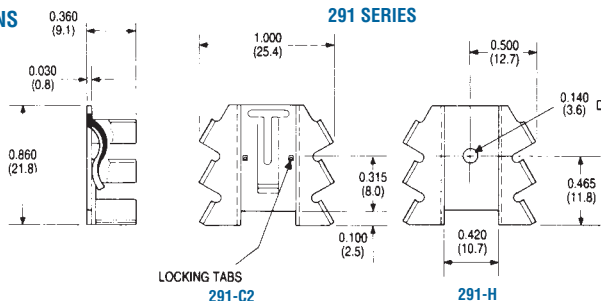

Dimensions: in. (mm)

NATURAL AND FORCED CONVECTION CHARACTERISTICS

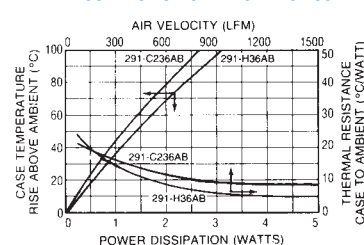

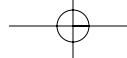

Board Level Heat Sinks



BOARD LEVEL POWER SEMICONDUCTOR HEAT SINKS



286 SERIES

Aluminum and Copper Low-Cost Wave-Solderable Heat Sinks

See also 286DB Series on Page 7.

TO-220

Standard P/N	Height Above PC Board in. (mm)	Maximum Footprint in. (mm)	Material	Thermal Performance at Typical Load		Weight lbs. (grams)
				Natural Convection	Forced Convection	
286-AB	1.190 (30.2)	1.000 (25.4) x 0.500 (12.7)	Aluminum, Anodized	58°C @ 4W	7.4°CW @ 200 LFM	0.0085 (3.86)
286-CBTE	1.190 (30.2)	1.000 (25.4) x 0.500 (12.7)	Copper, Black	58°C @ 4W	7.4°CW @ 200 LFM	0.0250 (11.34)
286-CTE	1.190 (30.2)	1.000 (25.4) x 0.500 (12.7)	Copper, Tinned	58°C @ 4W	7.4°CW @ 200 LFM	0.0250 (11.34)

Efficient heat removal at low cost can be achieved by inserting the 286 Series directly into pre-drilled circuit boards; scored mounting tabs may be bent after insertion to provide added stability. The 286 Series can be wavesoldered directly to

the board. Material: 286-AB style (aluminum, black anodized), 286-CBT style (copper, black paint tin tabs), and 286-CT style (copper, tinned).

MECHANICAL DIMENSIONS

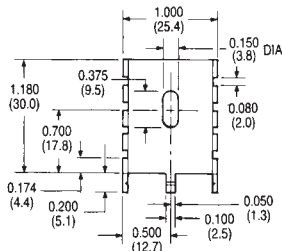

Dimensions: in. (mm)

286 SERIES

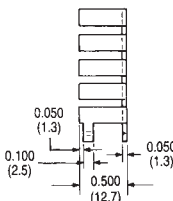

NATURAL AND FORCED CONVECTION CHARACTERISTICS

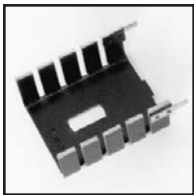
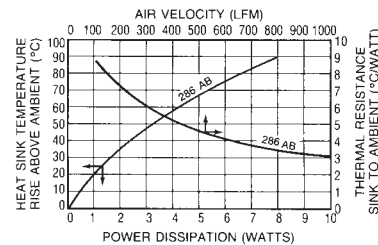

287 SERIES

Wave-Solderable Low-Cost Heat Sinks

TO-220

Standard P/N	Mounting Slot	Mounting Hole	Height Above PC Board in. (mm)	Maximum Footprint "A" in. (mm)	Thermal Performance at Typical Load		Weight lbs. (grams)
					Natural Convection	Forced Convection	
287-1ABE	287-1ABH	287-1ABH	1.180 (30.0)	1.000 (25.4) x 0.500 (12.7)	65°C @ 4W	7.8°CW @ 200 LFM	0.0090 (4.08)
287-2ABE	287-2ABH	287-2ABH	1.180 (30.0)	1.000 (25.4) x 1.000 (25.4)	55°C @ 4W	6.4°CW @ 200 LFM	0.0140 (6.35)

Material: Aluminum, Black Anodized

Mount these cost-effective TO-220 heat sinks vertically into pre-drilled printed circuit boards. Soldered, pre-tinned tabs can be wavesoldered directly to the

board. A 0.375 in. (9.5 mm) mounting slot allows for correct positioning of TO-220 and similar semiconductor packages.

MECHANICAL DIMENSIONS

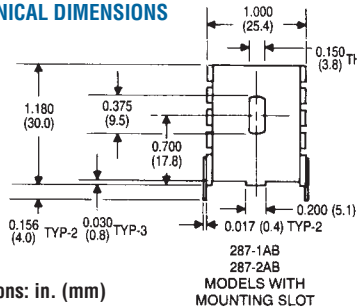

Dimensions: in. (mm)

287 SERIES

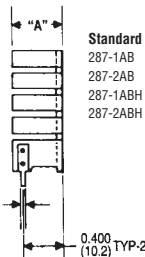
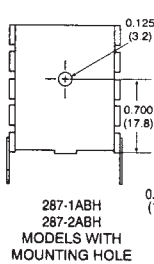

Standard P/N	Dim. "A"
287-1AB	0.500 (12.7)
287-2AB	1.000 (25.4)
287-1ABH	0.500 (12.7)
287-2ABH	1.000 (25.4)

NATURAL AND FORCED CONVECTION CHARACTERISTICS

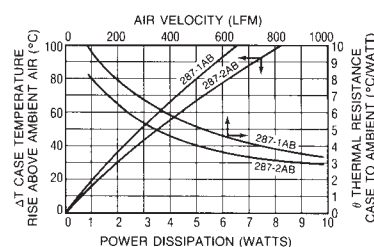

285 & 330 SERIES

285 SC and 330 SC SpeedClips™

Standard P/N	Nominal Installed Loading Force	For Use With Series	Material	Weight lbs. (grams)
285 SC	10 lbs	232, 237, 240, 252, 667	Carbon Steel	0.00053 (0.24)
330 SC	4 lbs	232, 237, 240, 252, 667	Stainless Steel	0.00074 (0.34)

SpeedClips™ employ a locking safety tab for mounting. Must be ordered separately for these heat sink series. Use these SpeedClips™ with our 237, 240, and 252 Series heat sinks for the lowest production assembly time and cost. Order

one SpeedClip™ for each heat sink purchased. Must be purchased with heat sinks.

MECHANICAL DIMENSIONS

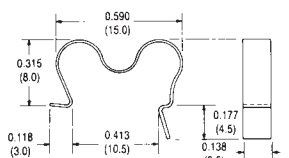

Dimensions: in. (mm)

Speed Clip 330 SC
4 lb (17.8N) Nominal Force Installed

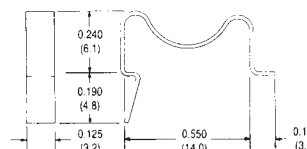

Speed Clip 285 SC
10 lb (44.5N) Nominal Force Installed

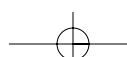



BOARD LEVEL POWER SEMICONDUCTOR HEAT SINKS



695 SERIES

Space-Saving Heat Sinks for Small Stud-Mounted Diodes

STUD-MOUNT

Standard P/N	Maximum Width in. (mm)	Height in. (mm)	Thermal Performance at Typical Load		Weight lbs. (grams)
			Natural Convection	Forced Convection	
695-1B	1.330 (33.8)	0.530 (13.7)	72°C @ 4.0W	5.2°C/W @ 400 LFM	0.008 (4.0)

Mount and effectively heat sink small stud-mounted diodes with the 695 Series space-saving heat sink type. Each unit is black anodized aluminum with an 0.200 in. (5.1) dia. mounting hole centered in the base. The folded fin design

provides good heat dissipation for use where height is limited above the printed circuit board or base plate.

MECHANICAL DIMENSIONS

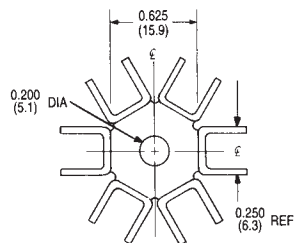

Dimensions: in. (mm)

695 SERIES

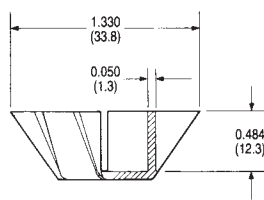

NATURAL AND FORCED CONVECTION CHARACTERISTICS

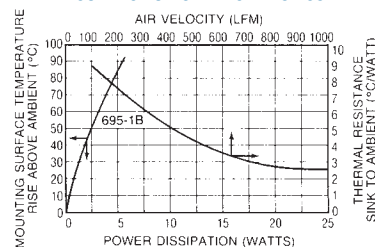

260 SERIES

Cup Clips for TO-5 Case Style Semiconductors

TO-5

Characteristics	TO-5
Thermal Resistance – Epoxy Insulated	14° C/W
Breakdown Voltage – Epoxy Type (VAC), 60 Hz	500
Recommended Operating Voltage, AC or DC	
Clean Conditions: % Hipot Rating	50
Dusty Conditions: % Hipot Rating	30
Dirty Conditions: % Hipot Rating	10 to 20
Temperature Range — Continuous (C°)	-73/+149

Model	Depth of Tapped Base
260-4T5E	0.093 (2.36)
260-4TH5E	0.125 (3.18)

Thread Size:
4 = #4-40 UNC
6 = #6-32 UNC

Mounting Style:
T = tapped
S = stud
P = plain

Base Style: H = hex
Semiconductor Case Style: 5 = TO-5
Insulation: E = epoxy



TO-5 CASE STYLE CUP CLIPS — ORDERING GUIDE

Standard P/N	Insulation Type	Outline Dimension L x W x I.D. in. (mm)	Weight lbs. (grams)	Case Style
260-4T5E	Epoxy Insulated	0.370 (9.4) x 0.380 (9.7) dia. x 0.290 (7.4)	0.0024 (1.09)	TO-5
260-4TH5E	Epoxy Insulated	0.400 (10.2) x 0.370 (9.4) hex. x 0.290 (7.4)	0.0031 (1.41)	TO-5
260-6SH5E	Epoxy Insulated	0.557 (14.1) x 0.370 (9.4) hex. x 0.290 (7.4)	0.0037 (1.68)	TO-5

Materials and Finish: Cups – beryllium copper, black ebonol “C”; Bases – brass, black ebonol “C”

Base Mounting Configurations — TO-5

Plain Type — Epoxy bonded, or used with #4 pan head screws.

Tapped Base — #4-40 UNC screw (not supplied) fits tapped hole. Care should be taken not to use too long a screw, which could short against the semiconductor case. For correct screw lengths:

Correct Screw Length (L) = Depth of Base + Panel Thickness + Washer Thickness

Stud Mounting Base. #6-32 UNC. Nuts and washers not supplied. Stud hole must be slightly countersunk to ensure flat mounting.

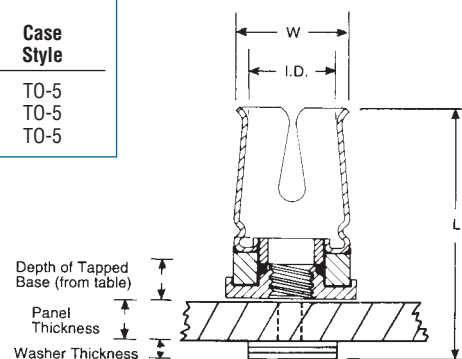
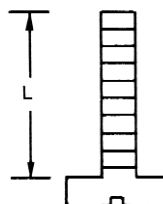

To determine the correct mounting screw lengths, add dimensions as follows:

Correct Screw Length (L) = Depth of Base + Panel Thickness + Washer Thickness

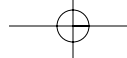

Board Level Heat Sinks



BOARD LEVEL POWER SEMICONDUCTOR HEAT SINKS

260 SERIES

Epoxy Insulated For TO-5

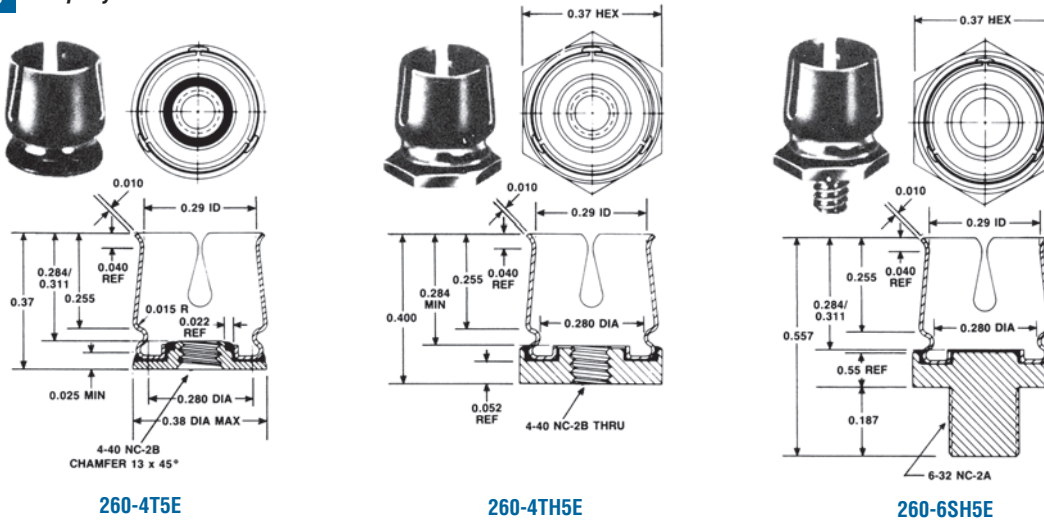

260-4T5E

260-4TH5E

260-6SH5E



258 SERIES

Thermal Links for Fused Glass Diodes

DIODES

Standard P/N	Dimensions in. (mm)	Material	Finish	Weight lbs. (grams)
258	0.500 (12.7) x 0.250 (6.4) x 0.340 (8.6)	Aluminum	DeltaCoate™ 151 on all surfaces except solder pads and base	0.0018 (0.82)

The thermal resistance from diode leads to chassis or heat sink is 12°C/watt, when unit is mounted with TYPE 120 Joint Compound. If a 10°C/watt chassis or

sink to ambient impedance is available, the thermal resistance from the diode leads to ambient is reduced from about 150°C/watt to 22°C/watt.

MECHANICAL DIMENSIONS

258 SERIES

Dimensions: in. (mm)

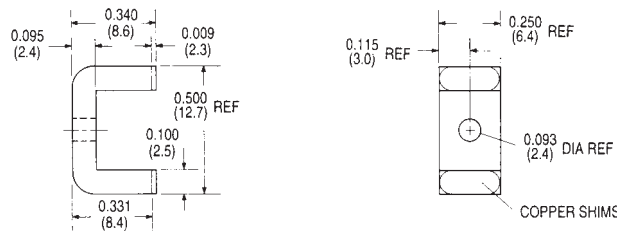

292 SERIES

Heat Sink for Single TO-92

TO-92

Standard P/N	Height Above PC Board in. (mm)	Overall Fin Width in. (mm)	Thermal Performance Natural Convection	Finish	Weight lbs. (grams)
292-AB	0.750 (19.1)	0.600 (15.3)	0.225°C/W @ 0.250 W	Black Anodized	0.00049 (0.22)

Power semiconductors packaged in a TO-92 style plastic case can be cooled effectively at little additional cost with the addition of the 292-AB heat sink. The

292-AB is effective over the typical power range of such devices. Material: Aluminum, Black Anodized

MECHANICAL DIMENSIONS

Dimensions: in. (mm)

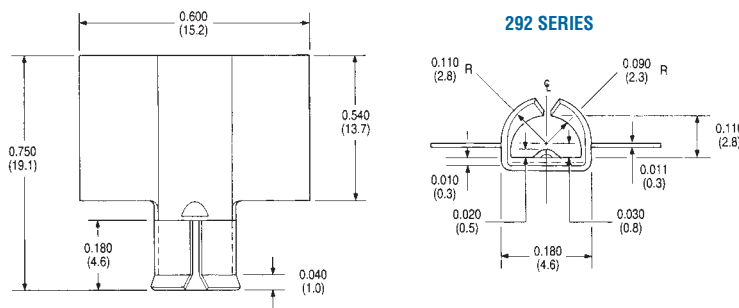

292 SERIES

NATURAL AND FORCED CONVECTION CHARACTERISTICS

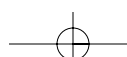
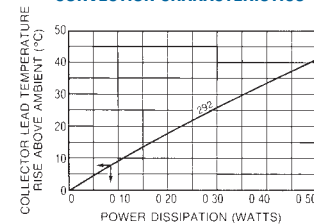



BOARD LEVEL POWER SEMICONDUCTOR HEAT SINKS

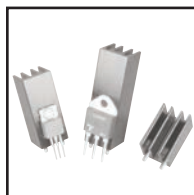

634 SERIES Slim Profile Unidirectional Fin Vertical Mount Heat Sink

TO-220 and TO-218

Plain Pin	Standard P/N		Height Above PC Board in. (mm)	Footprint Dimensions in. (mm)	Weight lbs. (grams)
	Without Pin	With Pin			
634-10ABEP	634-10AB		1.000 (25.4)	0.640 (16.26) x 0.640 (16.26)	0.016 (7.48)
634-15ABEP	634-15AB		1.500 (38.1)	0.640 (16.26) x 0.640 (16.26)	0.025 (11.21)
634-20ABEP	634-20AB		2.000 (50.8)	0.640 (16.26) x 0.640 (16.26)	0.033 (14.95)

Material: Aluminum, Black Anodized.

These slim profile unidirectional fin heat sinks offer users two assembly alternatives for vertically mounting TO-220 and TO-218 components. Models are available with or without wave-

solderable pins on 0.40 in. (10.2) centers, making them ideal for a variety of applications where quick assembly is needed and space is at a premium.

MECHANICAL DIMENSIONS

634 SERIES

Notes:

1. Thermal compound is assumed between device and heat sink.
2. Tab temp with longer heat sink (634-20ABP) will typically be about 15% cooler. Tab temp with shorter heat sink (634-10ABP) will typically be about 25% higher.

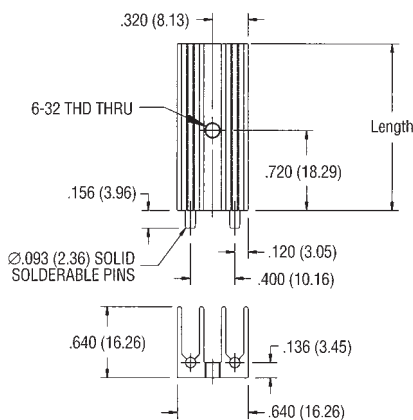

Dimensions: in. (mm)

TYPICAL THERMAL PERFORMANCE FOR 634-15ABP

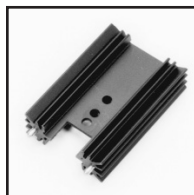
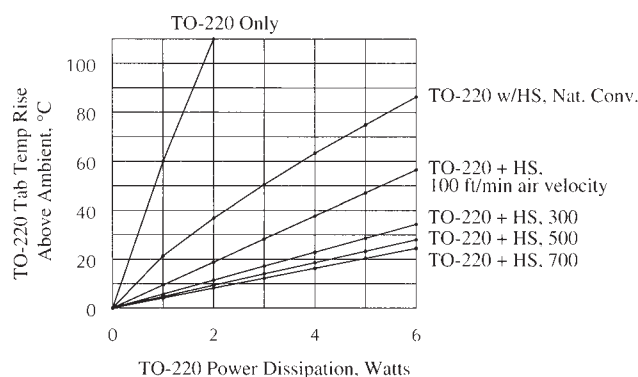

637 SERIES High-Efficiency Heat Sinks For Vertical Board Mounting

TO-220

Standard P/N	Height Above PC Board "A" in. (mm)	Maximum Footprint in. (mm)	Thermal Performance at Typical Load		Weight lbs. (grams)
			Natural Convection	Forced Convection	
637-10ABEP	1.000 (25.4)	1.375 (34.9) x 0.500 (12.7)	76°C @ 6W	5.8°C/W @ 200 LFM	0.023 (10.43)
637-15ABEP	1.500 (38.1)	1.375 (34.9) x 0.500 (12.7)	65°C @ 6w	5.5°C/W @ 200 LFM	0.035 (15.88)
637-20ABEP	2.000 (50.8)	1.375 (34.9) x 0.500 (12.7)	55°C @ 6W	4.7°C/W @ 200 LFM	0.050 (22.68)
637-25ABEP	2.500 (63.5)	1.375 (34.9) x 0.500 (12.7)	48°C @ 6W	4.2°C/W @ 200 LFM	0.062 (28.12)

Material: Aluminum, Black Anodized

Wave-solderable pins on 1 in. centers for vertical mounting on printed circuit boards. Maximum semiconductor package width 0.625 in. (15.9). Use this heat sink where weight and

board space occupied must be minimized. Refer to the Accessory products section for thermal interface materials, thermal compounds, and other accessories products.

MECHANICAL DIMENSIONS

637 SERIES (EXTRUSION PROFILE 5183)

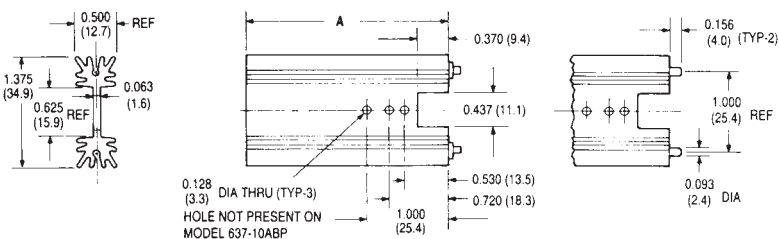

Dimensions: in. (mm)

NATURAL AND FORCED CONVECTION CHARACTERISTICS

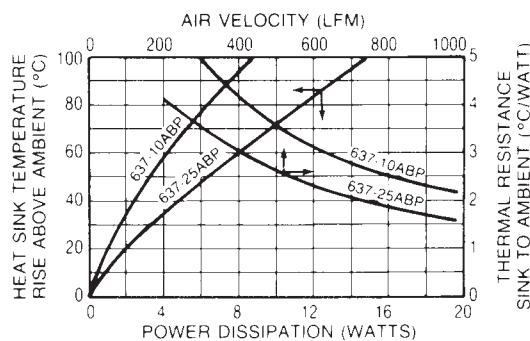

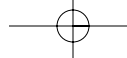

Board Level Heat Sinks



BOARD LEVEL POWER SEMICONDUCTOR HEAT SINKS

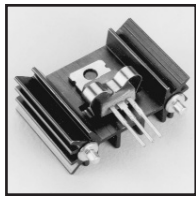

667 SERIES Labor-Saving SpeedClip™ Heat Sinks for Vertical Board Mounting

TO-220

Standard P/N Standoff Pin	Standard P/N Plain Pin	Height Above PC Board "A" in. (mm)	Maximum Footprint in. (mm)	Thermal Performance at Typical Load		Weight lbs (grams)
				Natural Convection	Forced Convection	
667-10ABESP	667-10ABPP	1.000 (25.4)	1.375 (34.9) x 0.500 (12.7)	76°C @ 6W	5.8°C/W @ 200 LFM	0.0240 (11.0)
667-15ABESP	667-15ABPP	1.500 (38.1)	1.375 (34.9) x 0.500 (12.7)	66°C @ 6W	5.5°C/W @ 200 LFM	0.0340 (15.6)
667-20ABESP	667-20ABPP	2.000 (50.8)	1.375 (34.9) x 0.500 (12.7)	58°C @ 6W	4.7°C/W @ 200 LFM	0.0460 (21.0)
667-25ABESP	667-25ABPP	2.500 (63.5)	1.375 (34.9) x 0.500 (12.7)	48°C @ 6W	4.2°C/W @ 200 LFM	0.0580 (26.2)

Wave-solderable pins. Material: Aluminum, Black Anodized

Excellent performance, choice of wave-solderable plain pins (PP-Type) or wave-solderable hex-shaped standoff pins (SP-Type), and reduced assembly cost.
Note: Order 330 SC or 285 SC SpeedClip™ separately.

MECHANICAL DIMENSIONS

Dimensions: in. (mm)

667 SERIES
(EXTRUSION PROFILE 8073)

STANDOFF PINS "SP"
PLAIN PINS "PP"

NATURAL AND FORCED CONVECTION CHARACTERISTICS

AIR VELOCITY (FPM)

HEAT SINK TEMPERATURE RISE ABOVE AMBIENT (°C)

THERMAL RESISTANCE SINK TO AMBIENT (°C/WATT)

POWER DISSIPATION (WATTS)

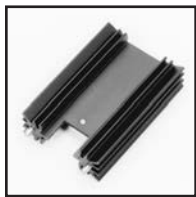

626 & 627 SERIES High-Efficiency Heat Sinks for Vertical Board Mounting

TO-218, TO-220

Standard P/N	Standard P/N	Height Above PC Board "A" in. (mm)	Maximum Footprint in. (mm)	Thermal Performance at Typical Load	
				Natural Convection	Forced Convection
626-10ABEP	627-10ABP	1.000 (25.4)	1.375 (34.9) x .500 (12.7)	76°C @ 6W	5.8°C/W @ 200 LFM
626-15ABEP	627-15ABP	1.500 (38.1)	1.375 (34.9) x .500 (12.7)	65°C @ 6W	5.5°C/W @ 200 LFM
626-20ABEP	627-20ABP	2.000 (50.8)	1.375 (34.9) x .500 (12.7)	55°C @ 6W	4.7°C/W @ 200 LFM
626-25ABEP	627-25ABP	2.500 (63.5)	1.375 (34.9) x .500 (12.7)	48°C @ 6W	4.2°C/M @ 200 LFM

Wave-solderable pins. Material: Aluminum, Black Anodized

MECHANICAL DIMENSIONS

Dimensions: in. (mm)

626 AND 627 SERIES

NATURAL AND FORCED CONVECTION CHARACTERISTICS

AIR VELOCITY (LFM)

HEAT SINK TEMPERATURE RISE ABOVE AMBIENT AIR (°C)

THERMAL RESISTANCE SINK TO AMBIENT (°C/WATT)

POWER DISSIPATION (WATTS)

Series	Type Device	Hole Diameter "B"	Hole Height "C"	Webb Width "D"	Notch Width "E"	Extrusion Profile
626	TO-218	.144 (3.7)	.850 (21.6)	.660 (16.8)	.540 (13.7)	8420
627	TO-220	.128 (3.3)	.720 (18.3)	.625 (15.9)	.437 (11.1)	5183

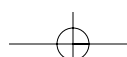



BOARD LEVEL POWER SEMICONDUCTOR HEAT SINKS

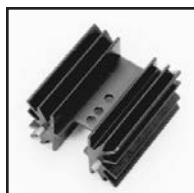

647 SERIES High-Performance Heat Sinks for Vertical Board Mounting

TO-220

Standard P/N	Height Above PC Board "A" in. (mm)	Maximum Footprint in. (mm)	Thermal Performance at Typical Load		Weight lbs. (grams)
			Natural Convection	Forced Convection	
647-10ABEP	1.000 (25.4)	1.650 (41.9) x 1.000 (25.4)	42°C @ 6W	3.8°C/W @ 200 LFM	0.055 (24.95)
647-15ABEP	1.500 (38.1)	1.650 (41.9) x 1.000 (25.4)	37°C @ 6W	3.5°C/W @ 200 LFM	0.075 (34.02)
647-175ABEP	1.750 (44.5)	1.650 (41.9) x 1.000 (25.4)	34°C @ 6W	3.3°C/W @ 200 LFM	0.090 (40.82)
647-20ABEP	2.000 (50.8)	1.650 (41.9) x 1.000 (25.4)	31°C @ 6W	3.1°C/W @ 200 LFM	0.104 (47.17)
647-25ABEP	2.500 (63.5)	1.650 (41.9) x 1.000 (25.4)	25°C @ 6W	2.8°C/W @ 200 LFM	0.125 (56.70)

Material: Aluminum, Black Anodized

Wave-solderable pins on 1 in. centers for vertical mounting of larger devices on printed circuit boards. Maximum semiconductor package width: 0.625 (15.9). Refer to the Accessory

Products section for thermal interface materials, 126 Series silicone-free thermal compounds, and other accessories products.

MECHANICAL DIMENSIONS

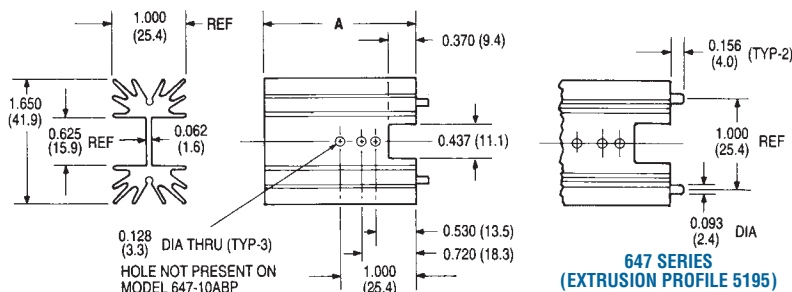

Dimensions: in. (mm)

NATURAL AND FORCED CONVECTION CHARACTERISTICS

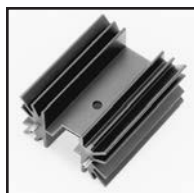
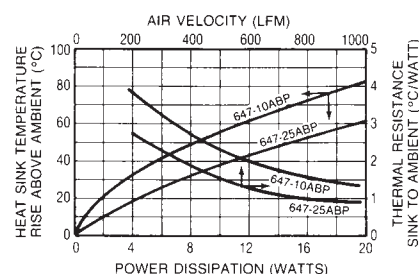

657 SERIES High-Performance Heat Sinks for Vertical Board Mounting

TO-220, TO-247, TO-218

Standard P/N	Height Above PC Board "A" in. (mm)	Maximum Footprint in. (mm)	Thermal Performance at Typical Load		Weight lbs. (grams)
			Natural Convection	Forced Convection	
657-10ABEP	1.000 (25.4)	1.650 (41.9) x 1.000 (25.4)	41°C @ 6W	3.7°C/W @ 200 LFM	0.0515 (23.36)
657-15ABEP	1.500 (38.1)	1.650 (41.9) x 1.000 (25.4)	38°C @ 6W	3.3°C/W @ 200 LFM	0.0760 (34.60)
657-20ABEP	2.000 (50.8)	1.650 (41.9) x 1.000 (25.4)	32°C @ 6W	2.9°C/W @ 200 LFM	0.1030 (47.00)
657-25ABEP	2.500 (63.5)	1.650 (41.9) x 1.000 (25.4)	25°C @ 6W	2.7°C/W @ 200 LFM	0.1250 (57.00)

Wave-solderable pins. Material: Aluminum, Black Anodized

MECHANICAL DIMENSIONS

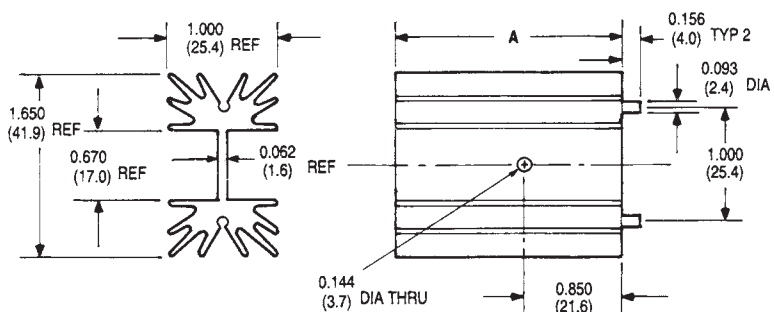

Dimensions: in. (mm)

NATURAL AND FORCED CONVECTION CHARACTERISTICS

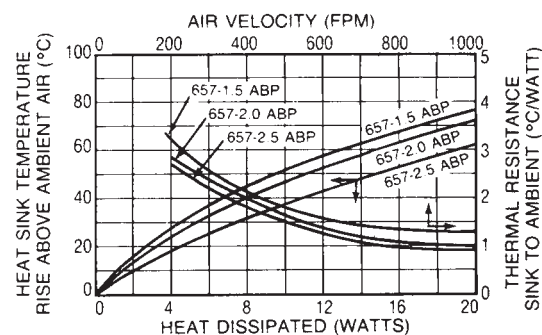



Board Level Heat Sinks



BOARD LEVEL POWER SEMICONDUCTOR HEAT SINKS

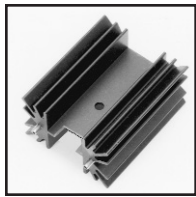

657 SERIES High-Performance Notched Heat Sinks for Vertical Board Mounting

TO-220, TO-247, TO-218

Standard P/N	Height Above PC Board "A" in. (mm)	Maximum Footprint in. (mm)	Thermal Performance at Typical Load Natural Convection	Thermal Performance at Typical Load Forced Convection
657-10ABEPN	1.000 (25.4)	1.650 (41.9) x 1.000 (25.4)	41°C @ 6W	3.7°C/W @ 200 LFM
657-15ABEPN	1.500 (38.1)	1.650 (41.9) x 1.000 (25.4)	38°C @ 6W	3.3°C/W @ 200 LFM
657-20ABEPN	2.000 (50.8)	1.650 (41.9) x 1.000 (25.4)	32°C @ 6W	2.9°C/W @ 200 LFM
657-25ABEPN	2.500 (63.5)	1.650 (41.9) x 1.000 (25.4)	25°C @ 6W	2.7°C/W @ 200 LFM

Wave-solderable pins. Material: Aluminum, Black Anodized

MECHANICAL DIMENSIONS

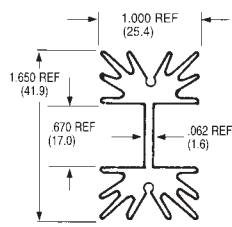

Dimensions: in. (mm)

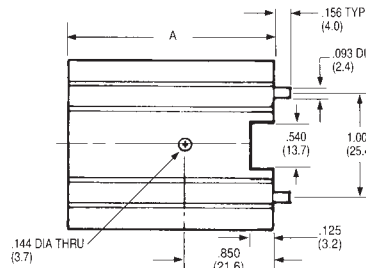

657 SERIES

657 SERIES (EXTRUSION PROFILE 6533)

NATURAL AND FORCED CONVECTION CHARACTERISTICS

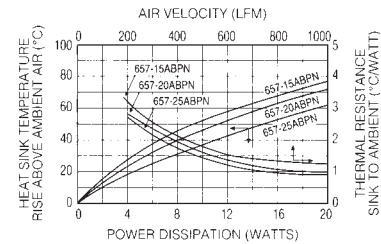

657 SERIES High-Performance Heat Sinks with SpeedClips™ for Vertical Board Mounting

TO-220, TO-247, TO-218

Standard P/N	Height Above PC Board "A" in. (mm)	Maximum Footprint in. (mm)	Thermal Performance at Typical Load Natural Convection	Thermal Performance at Typical Load Forced Convection
657-10ABEPSC	1.000 (25.4)	1.650 (41.9) x 1.000 (25.4)	41°C @ 6W	3.7°C/W @ 200 LFM
657-15ABEPSC	1.500 (38.1)	1.650 (41.9) x 1.000 (25.4)	38°C @ 6W	3.3°C/W @ 200 LFM
657-20ABEPSC	2.000 (50.8)	1.650 (41.9) x 1.000 (25.4)	32°C @ 6W	2.9°C/W @ 200 LFM
657-25ABEPSC	2.500 (63.5)	1.650 (41.9) x 1.000 (25.4)	25°C @ 6W	2.7°C/W @ 200 LFM

Wave-solderable pins. Material: Aluminum, Black Anodized

MECHANICAL DIMENSIONS

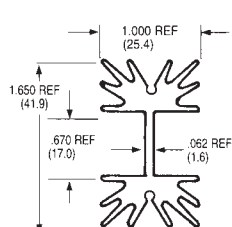

Dimensions: in. (mm)

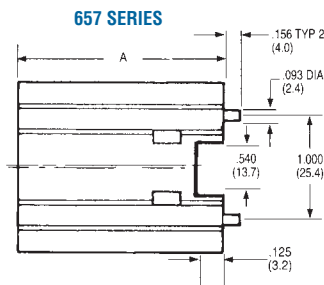

SPEEDCLIP™ INCLUDED IN ORDER

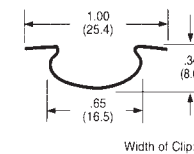

657 SERIES (EXTRUSION PROFILE 6533)

NATURAL AND FORCED CONVECTION CHARACTERISTICS

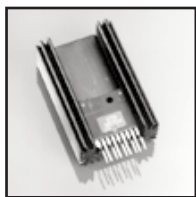
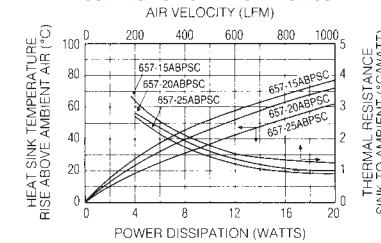

677 SERIES High-Performance, High-Power Heat Sinks for Vertical Board Mounting

TO-218, TO-220, TO-247 15-LEAD Multiwatt

Standard P/N	Height Above PC Board "A" in. (mm)	Maximum Footprint in. (mm)	Thermal Performance at Typical Load Natural Convection	Thermal Performance at Typical Load Forced Convection
677-10ABEP	1.000 (25.4)	1.650 (41.9) x 1.000 (25.4)	52°C @ 6W	3.1°C/W @ 200 LFM
677-15ABEP	1.500 (38.1)	1.650 (41.9) x 1.000 (25.4)	46°C @ 6W	2.8°C/W @ 200 LFM
677-20ABEP	2.000 (50.8)	1.650 (41.9) x 1.000 (25.4)	40°C @ 6W	2.5°C/W @ 200 LFM
677-25ABEP	2.500 (63.5)	1.650 (41.9) x 1.000 (25.4)	35°C @ 6W	2.2°C/W @ 200 LFM

Wave-solderable pins. Material: Aluminum, Black Anodized

MECHANICAL DIMENSIONS

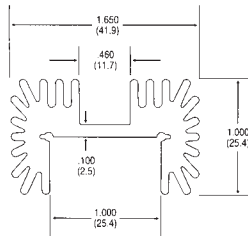

Dimensions: in. (mm)

677 SERIES

677 SERIES (EXTRUSION PROFILE 8719)

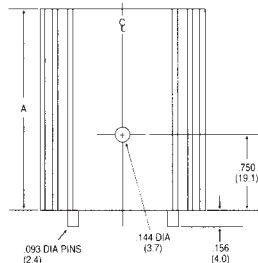

NATURAL AND FORCED CONVECTION CHARACTERISTICS

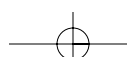
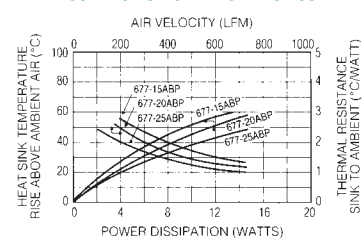



BOARD LEVEL POWER SEMICONDUCTOR HEAT SINKS



690 SERIES Highest Efficiency/Lowest Unit Cost Heat Sinks

TO-3, TO-66, TO-220

Standard P/N	Height Above PC Board in. (mm)	Outline Dimensions in. (mm)	Thermal Performance at Typical Load Natural Convection	Thermal Performance at Typical Load Forced Convection	Semiconductor Mounting Hole Pattern	Weight lbs. (grams)
690-3B	1.310 (33.3)	1.860 (47.2)-sq	44°C @ 7.5W	2.0°C/W @ 400 LFM	(1) TO-3	0.0700 (31.75)
690-66B	1.310 (33.3)	1.860 (47.2)-sq	44°C @ 7.5W	2.0°C/W @ 400 LFM	(1) TO-66	0.0700 (31.75)
690-220B	1.310 (33.3)	1.860 (47.2)-sq	44°C @ 7.5W	2.0°C/W @ 400 LFM	(2) TO-220	0.0700 (31.75)

Material: Aluminum, Black Anodized

These low-cost heat sinks provide the most power dissipation at the lowest unit cost and are available in three standard types to mount and cool one TO-3 or TO-66 metal power semiconductor type or two plastic package TO-220 power semiconductor types. For higher power

semiconductors, the 690 Series can dissipate up to 20 watts while maintaining a mounting surface temperature rise above ambient air temperature of no more than 91°C.

MECHANICAL DIMENSIONS

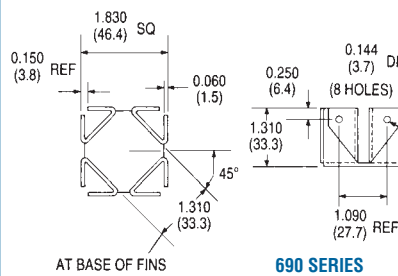

Dimensions: in. (mm)

SEMICONDUCTOR MOUNTING HOLES

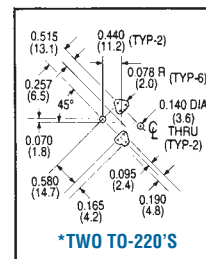
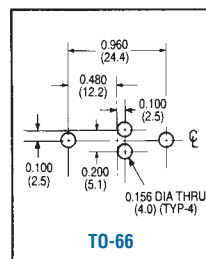
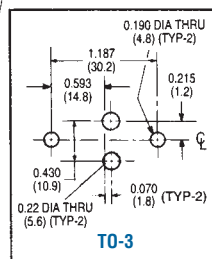

NATURAL AND FORCED CONVECTION CHARACTERISTICS

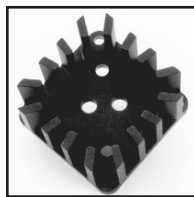
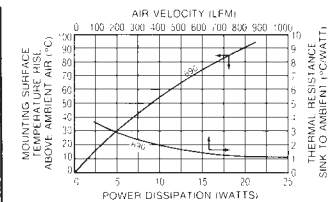

680 SERIES Maximum Efficiency Omnidirectional Heat Sinks

TO-3, TO-220

Standard P/N	Height Above PC Board "A" in. (mm)	Horizontal Mounting Footprint Dimensions in. (mm)	Thermal Performance at Typical Load Natural Convection	Thermal Performance at Typical Load Forced Convection	Semiconductor Mounting Hole Pattern	Weight lbs. (grams)
680-5A	0.500 (12.7)	1.810 (46.0)-sq	70°C @ 7.5W	3.0°C/W @ 400 LFM	(1) TO-3	0.0700 (31.75)
680-75A	0.750 (19.1)	1.810 (46.0)-sq	58°C @ 7.5W	2.4°C/W @ 400 LFM	(1) TO-3	0.0900 (40.82)
680-10A	1.000 (25.4)	1.810 (46.0)-sq	52°C @ 7.5W	2.0°C/W @ 400 LFM	(1) TO-3	0.0980 (44.45)
680-125A	1.250 (31.8)	1.810 (46.0)-sq	45°C @ 7.5W	1.5°C/W @ 400 LFM	(1) TO-3	0.1100 (49.90)
680-5220	0.500 (12.7)	1.810 (46.0)-sq	70°C @ 7.5W	3.0°C/W @ 400 LFM	(2) TO-220	0.0700 (31.75)
680-75220	0.750 (19.1)	1.810 (46.0)-sq	58°C @ 7.5W	2.4°C/W @ 400 LFM	(2) TO-220	0.0900 (40.82)
680-10220	1.000 (25.4)	1.810 (46.0)-sq	52°C @ 7.5W	2.0°C/W @ 400 LFM	(2) TO-220	0.0980 (44.45)
680-125220	1.250 (31.8)	1.810 (46.0)-sq	45°C @ 7.5W	1.5°C/W @ 400 LFM	(2) TO-220	0.1100 (49.90)

Material: Aluminum, Black Anodized

Achieve optimum natural convection cooling per unit volume occupied above the printed circuit board for TO-3 (one semiconductor package per heat sink) or for two TO-220 style cases, when this low-cost heat sink is used. Any mounting attitude will provide free circulation of air in

natural convection applications. These 680 Series heat sinks can also be specified without any semiconductor mounting hole pattern by specifying suffix "K" (Example: 680-5K).

MECHANICAL DIMENSIONS

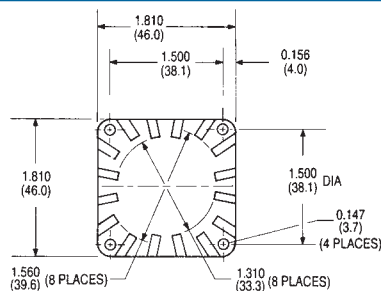

Dimensions: in. (mm)

680 SERIES

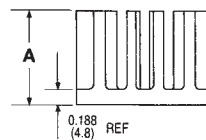

NATURAL AND FORCED CONVECTION CHARACTERISTICS

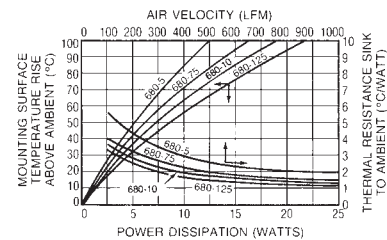

SEMICONDUCTOR MOUNTING HOLES

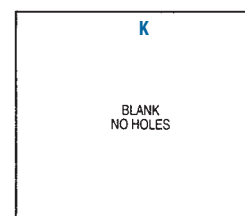
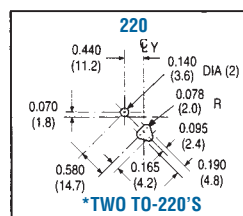
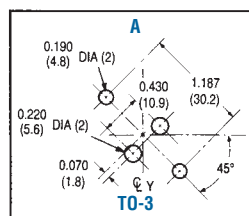

*Only one hole pattern of two is shown. Hole patterns are symmetrical about the center lines.

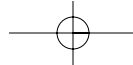

Board Level Heat Sinks



BOARD LEVEL POWER SEMICONDUCTOR HEAT SINKS

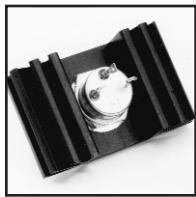

601 & 603 SERIES Low-Height Heat Sinks

DO-4/DO-5 Diodes

Standard P/N	Footprint Dimensions in. (mm)	Height in. (mm)	Mounting Hole Dia. in. (mm)	Thermal Performance at Typical Load		Weight lbs. (grams)
				Natural Convection	Forced Convection	
601E	2.000 (50.8) x 1.250 (31.8)	0.562 (14.3)	0.200 (5.1)	52°C @ 5.0W	4.5°C/W @ 175 LFM	0.0500 (22.68)
601F	2.000 (50.8) x 1.250 (31.8)	0.562 (14.3)	0.270 (6.9)	52°C @ 5.0W	4.5°C/W @ 175 LFM	0.0500 (22.68)
601K	2.000 (50.8) x 1.250 (31.8)	0.562 (14.3)	None	52°C @ 5.0W	4.5°C/W @ 175 LFM	0.0500 (22.68)
603K	2.000 (50.8) x 2.000 (50.8)	0.562 (14.3)	None	41°C @ 5.0W	4.0°C/W @ 175 LFM	0.0810 (36.74)

Material: Aluminum Alloy, Black Anodized

Use these low-height heat sinks on printed circuit board applications for TO-66 power semi-conductors and DO-4 and DO-5 diodes, where close board-to-board spacing and efficient heat

dissipation are required. The 601 and 603 Series may also be attached to enclosure panels or brackets using isolation hardware where necessary.

MECHANICAL DIMENSIONS

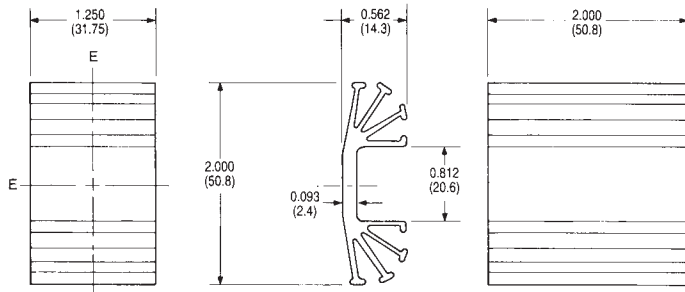

601 SERIES (EXTRUSION PROFILE 1284)

603 SERIES (EXTRUSION PROFILE 1284)

NATURAL AND FORCED CONVECTION CHARACTERISTICS

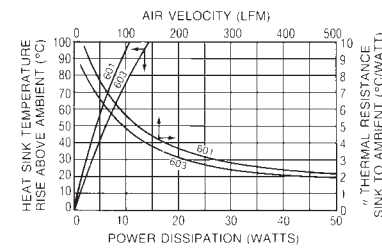

SEMICONDUCTOR MOUNTING HOLES

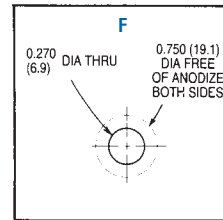
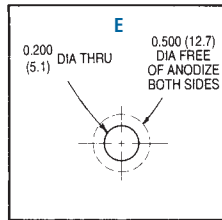
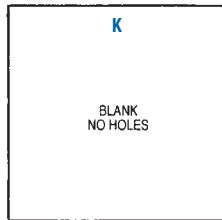

Dimensions: in. (mm)

E&F available on 601 Series only as a standard product.

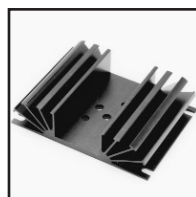

641 SERIES Maximum Performance Natural Convection Heat Sink for all Metal-Case Semiconductors

TO-3

Standard P/N	Outline Dimensions in. (mm)	Height in. (mm)	Mounting Hole Pattern	Thermal Performance at Typical Load		Weight lbs. (grams)
				Natural Convection	Forced Convection	
641A	4.125 (104.8) x 3.000 (76.2)	1.000 (25.4)	(1) TO-3	36°C @ 15W	0.9°C/W @ 250 LFM	0.2900 (131.54)
641K	4.125 (104.8) x 3.000 (76.2)	1.000 (25.4)	None	36°C @ 15W	0.9°C/W @ 250 LFM	0.2900 (131.54)

Available with a standard TO-3 mounting hole pattern predrilled for cost-effective mounting in limited-height applications, the 641 Series provides maximum performance in natural convection with an optimized heat sink surface area. The 641K type with an open channel area of

1.300 in. (33.0) and no predrilled mounting holes can be adapted to meet mounting requirements for most metal case power semiconductor types. Material: Aluminum Alloy, Black Anodized.

MECHANICAL DIMENSIONS

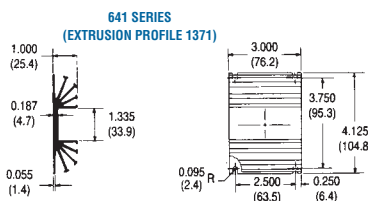

Dimensions: in. (mm)

SEMICONDUCTOR MOUNTING HOLES

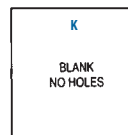
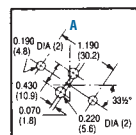

NATURAL AND FORCED CONVECTION CHARACTERISTICS

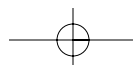
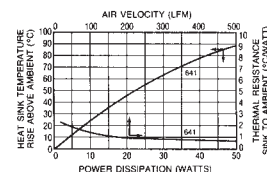

X-ON Electronics

Largest Supplier of Electrical and Electronic Components

Click to view similar products for [Heat Sinks](#) category:

Click to view products by [Wakefield](#) manufacturer:

Other Similar products are found below :

[581102B00000G](#) [630-35ABT3](#) [656-15ABPE](#) [657-20ABPNE](#) [7020B-TC12-MTG](#) [73452PPBA](#) [7721-13NG](#) [7G0011A](#) [FI306/SE](#) [PF720G](#)
[A22-4026](#) [120-1873-007](#) [HAH10L](#) [HF20](#) [1542256-2](#) [1542026-1](#) [1542616-1](#) [HS-2506-F1](#) [HS-87M0-F2](#) [218-40CTE3](#) [25-7520](#)
[188854F00000G](#) [F-QB-F1](#) [APA501-60-003](#) [253-122ABE-22](#) [PSC22CB](#) [CLP-201](#) [CLP212SG](#) [CLP-7701G](#) [HAA072](#) [HAA083](#) [HAF10L](#)
[HAQ10T](#) [D10100-28](#) [TO5-002D](#) [513101B02500G](#) [BDN183CBA01](#) [531202B0000](#) [HS-56M0-C1](#) [3-21053-4](#) [TX0506-1B](#) [TX1806B](#)
[336614B-00000](#) [V2004X](#) [LAE66A3CB](#) [WA-DT2-101E](#) [511-3U](#) [017177](#) [530510B00000G](#) [6110BG](#)