

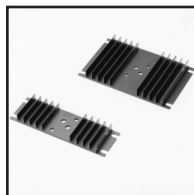

Extruded Heat Sinks

EXTRUDED HEAT SINKS FOR POWER SEMICONDUCTORS



621/623 SERIES

Low-Profile Heat Sinks for All Metal-Case Power Semiconductors

TO-3

Standard P/N	Footprint Dimensions in. (mm)	Height in. (mm)	Mounting Hole Pattern	Thermal Performance at Typical Load		Weight lbs. (grams)
				Natural Convection	Forced Convection	
621A	4.750 (120.6) x 1.500 (38.1)	0.461 (11.7)	(1) TO-3	75°C @ 15W	2.0°C/W @ 250 LFM	0.1000 (45.36)
621K	4.750 (120.6) x 1.500 (38.1)	0.461 (11.7)	None	75°C @ 15W	2.0°C/W @ 250 LFM	0.1000 (45.36)
623A	4.750 (120.6) x 3.000 (76.2)	0.461 (11.7)	(1) TO-3	52°C @ 15W	1.5°C/W @ 250 LFM	0.2100 (95.26)
623K	4.750 (120.6) x 3.000 (76.2)	0.461 (11.7)	None	52°C @ 15W	1.5°C/W @ 250 LFM	0.2100 (95.26)

A general purpose yet efficient heat dissipator for TO-3 and virtually all other styles of metal case power semiconductor package types, the 621 and 623 Series low-profile flat back heat sinks find a wide variety of applications. The central channel between fins measures 1.300 in. (33.0) (min.) in

width, accommodating many types of packages. Mounting hole pattern "A" is predrilled for the standard TO-3 package. Material: Aluminum Alloy, Black Anodized.

MECHANICAL DIMENSIONS

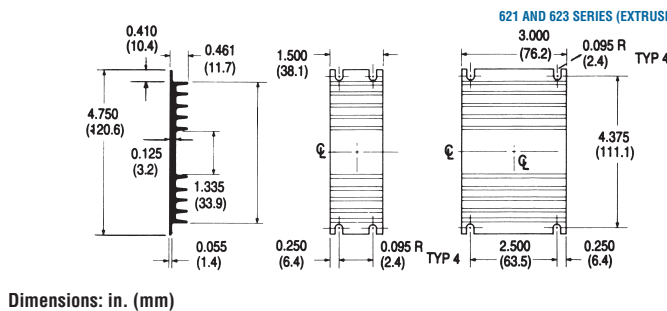

SEMICONDUCTOR MOUNTING HOLES

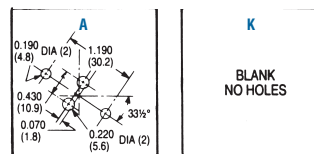

NATURAL AND FORCED CONVECTION CHARACTERISTICS

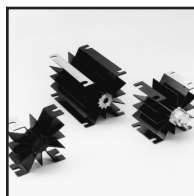
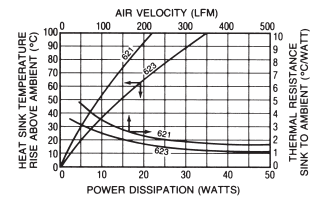

301/302/303 SERIES

Compact Heat Sinks for Dual Stud-Mounted Semiconductor Cases

STUD-MOUNT

Standard P/N	Outline Dimensions in. (mm)	Length "A" in. (mm)	Mounting Hole (s) Pattern and Number	Thermal Performance at Typical Load		Weight lbs. (grams)
				Natural Convection	Forced Convection	
301K	2.000 (50.8) x 2.000 (50.8)	0.750 (19.1)	None	70°C @ 15W	2.5°C/W @ 250 LFM	0.0580 (26.31)
301M	2.000 (50.8) x 2.000 (50.8)	0.750 (19.1)	(1) 10-32UNF, 0.625 in. thread depth	70°C @ 15W	2.5°C/W @ 250 LFM	0.0580 (26.31)
301N	2.000 (50.8) x 2.000 (50.8)	0.750 (19.1)	(1) 1/4-28UNF, 0.625 in. thread depth	70°C @ 15W	2.5°C/W @ 250 LFM	0.0580 (26.31)
302M	2.000 (50.8) x 2.000 (50.8)	1.500 (38.1)	(1) 10-32UNF, 0.625 in. thread depth	50°C @ 15W	1.8°C/W @ 250 LFM	0.1330 (60.33)
302MM	2.000 (50.8) x 2.000 (50.8)	1.500 (38.1)	(2) 10-32UNF, 0.625 in. thread depth	50°C @ 15W	1.8°C/W @ 250 LFM	0.1330 (60.33)
302N	2.000 (50.8) x 2.000 (50.8)	1.500 (38.1)	(1) 1/4-28UNF, 0.625 in. thread depth	50°C @ 15W	1.8°C/W @ 250 LFM	0.1330 (60.33)
302NN	2.000 (50.8) x 2.000 (50.8)	1.500 (38.1)	(2) 1/4-28UNF, 0.625 in. thread depth	50°C @ 15W	1.8°C/W @ 250 LFM	0.1330 (60.33)
303M	2.000 (50.8) x 2.000 (50.8)	3.000 (76.2)	(1) 10-32UNF, 0.625 in. thread depth	37°C @ 15W	1.3°C/W @ 250 LFM	0.2680 (121.56)
303MM	2.000 (50.8) x 2.000 (50.8)	3.000 (76.2)	(2) 10-32UNF, 0.625 in. thread depth	37°C @ 15W	1.3°C/W @ 250 LFM	0.2680 (121.56)
303N	2.000 (50.8) x 2.000 (50.8)	3.000 (76.2)	(1) 1/4-28UNF, 0.625 in. thread depth	37°C @ 15W	1.3°C/W @ 250 LFM	0.2680 (121.56)
303NN	2.000 (50.8) x 2.000 (50.8)	3.000 (76.2)	(2) 1/4-28UNF, 0.625 in. thread depth	37°C @ 15W	1.3°C/W @ 250 LFM	0.2680 (121.56)

The large fin area in minimum total volume provided by the radial design of the 301/302/303 Series offers maximum heat transfer efficiency in natural convection. All types are available with one tapped mounting hole for rectifiers and other stud-mounting semiconductors; the

302 and 303 Series offer maximum cost savings with dual mounting locations ("MM" and "NN" mounting hole patterns) for two stud-mount devices. Material: Aluminum Alloy, Black Anodized.

MECHANICAL DIMENSIONS

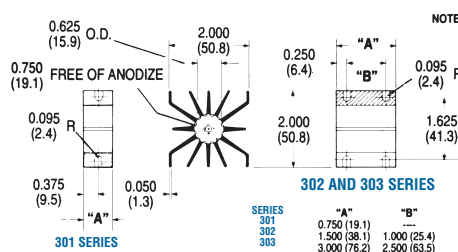

NOTE: CROSS-HATCHED AREAS FREE OF ANODIZE.

SEMICONDUCTOR MOUNTING HOLES

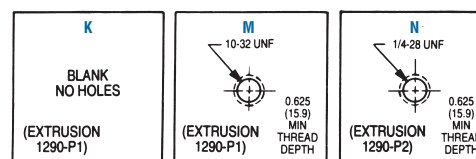

NATURAL AND FORCED CONVECTION CHARACTERISTICS

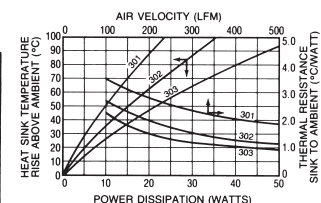

Extruded Heat Sinks



EXTRUDED HEAT SINKS FOR POWER SEMICONDUCTORS

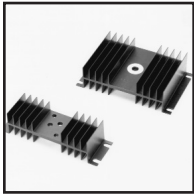

401 & 403 SERIES

Double-Surface Heat Sinks for TO-3 Case Styles

TO-3; Stud-Mount

Standard P/N	Width in. (mm)	Overall Dimensions in. (mm)	Height in. (mm)	Semiconductor Mounting Hole Pattern	Thermal Performance at Typical Load		Weight lbs. (grams)
					Natural Convection	Forced Convection	
401A	4.750 (120.7)	1.500 (38.1)	1.250 (31.8)	(1) TO-3	80°C @ 30W	1.5°C/W @ 250 LFM	0.1500 (68.04)
401F	4.750 (120.7)	1.500 (38.1)	1.250 (31.8)	0.270 in. (6.9)-Dia Hole	80°C @ 30W	1.5°C/W @ 250 LFM	0.1500 (68.04)
401K	4.750 (120.7)	1.500 (38.1)	1.250 (31.8)	None	80°C @ 30W	1.5°C/W @ 250 LFM	0.1500 (68.04)
403A	4.750 (120.7)	3.000 (76.2)	1.250 (31.8)	(1) TO-3	55°C @ 30W	0.9°C/W @ 250 LFM	0.3500 (158.76)
403F	4.750 (120.7)	3.000 (76.2)	1.250 (31.8)	0.270 in. (6.9)-Dia Hole	55°C @ 30W	0.9°C/W @ 250 LFM	0.3500 (158.76)
403K	4.750 (120.7)	3.000 (76.2)	1.250 (31.8)	None	55°C @ 30W	0.9°C/W @ 250 LFM	0.3500 (158.76)

With fins oriented vertically in cabinet sidewall applications, 401 and 403 Series heat sinks are recommended for critical space applications where maximum heat dissipation is required for high-power TO-3 case styles. Forced convection performance is also exemplary with these double surface fin types. Semiconductor mounting hole style "F" offers a single centered 0.270

in. (6.9)-diameter mounting hole (with a 0.750 in. (19.1)-diameter area free of anodize) for mounting stud-type diodes and rectifiers. Hole pattern "V" available upon request. Material: Aluminum Alloy, Black Anodized.

MECHANICAL DIMENSIONS

403 SERIES Dimensions: in. (mm)

401 SERIES Dimensions: in. (mm)

NATURAL AND FORCED CONVECTION CHARACTERISTICS

HEAT SINK TEMPERATURE RISE ABOVE AMBIENT (°C) vs POWER DISSIPATION (WATTS)

SEMICONDUCTOR MOUNTING HOLES

F 0.270 (6.9) DIA FREE OF ANODIZE BOTH SIDES

K BLANK NO HOLES

V 0.144 DIA (2) hole with 0.430 (10.9) diameter and 0.250 (6.4) diameter holes.

401 AND 403 SERIES (EXTRUSION PROFILE 1024)

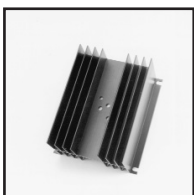

413/421/423 SERIES

Low-Height Double-Surface Heat Sinks for TO-3 Case Styles and Diodes

TO-3; DO-5; Stud-Mount

Standard P/N	Width in. (mm)	Nominal Dimensions		Height "A" in. (mm)	Semiconductor Mounting Hole Pattern	Thermal Performance at Typical Load		Weight lbs. (grams)
		Length in. (mm)	Length in. (mm)			Natural Convection	Forced Convection	
413A	4.750 (120.7)	3.000 (76.2)	1.875 (47.6)	1.875 (47.6)	(1) TO-3	72°C @ 50W	0.85°C/W @ 250 LFM	0.6300 (285.77)
413F	4.750 (120.7)	3.000 (76.2)	1.875 (47.6)	1.875 (47.6)	0.270 in. (6.9)-Dia Hole	72°C @ 50W	0.85°C/W @ 250 LFM	0.6300 (285.77)
413K	4.750 (120.7)	3.000 (76.2)	1.875 (47.6)	1.875 (47.6)	None	72°C @ 50W	0.85°C/W @ 250 LFM	0.6300 (285.77)
421A	4.750 (120.7)	3.000 (76.2)	2.625 (66.7)	2.625 (66.7)	(1) TO-3	58°C @ 50W	0.7°C/W @ 250 LFM	0.6300 (285.77)
421F	4.750 (120.7)	3.000 (76.2)	2.625 (66.7)	2.625 (66.7)	0.270 in. (6.9)-Dia Hole	58°C @ 50W	0.7°C/W @ 250 LFM	0.6300 (285.77)
421K	4.750 (120.7)	3.000 (76.2)	2.625 (66.7)	2.625 (66.7)	None	58°C @ 50W	0.7°C/W @ 250 LFM	0.6300 (285.77)
423A	4.750 (120.7)	5.500 (140.2)	2.625 (66.7)	2.625 (66.7)	(1) TO-3	47°C @ 50W	0.5°C/W @ 250 LFM	1.1700 (530.71)
423K	4.750 (120.7)	5.500 (140.2)	2.625 (66.7)	2.625 (66.7)	None	47°C @ 50W	0.5°C/W @ 250 LFM	1.1700 (530.71)

Space-saving double surface 413, 421, and 423 Series utilize finned surface area on both sides of the power semiconductor mounting surface to provide maximum heat dissipation in a compact profile. Ready to install on popular power components in natural and forced convection applications. Apply Wake-

field Type 126 silicone-free thermal compound or Wakefield DeltaPad™ interface materials for maximum performance. Material: Aluminum Alloy, Black Anodized.

MECHANICAL DIMENSIONS

413 SERIES (EXTRUSION PROFILE 2276)

421 SERIES (EXTRUSION PROFILE 1025)

423 SERIES (EXTRUSION PROFILE 1025)

NATURAL AND FORCED CONVECTION CHARACTERISTICS

HEAT SINK TEMPERATURE RISE ABOVE AMBIENT (°C) vs POWER DISSIPATION (WATTS)

SEMICONDUCTOR MOUNTING HOLES

F 0.270 (6.9) DIA FREE OF ANODIZE BOTH SIDES

K BLANK NO HOLES

V 0.144 DIA (2) hole with 0.430 (10.9) diameter and 0.250 DIA (4) diameter holes.

413 AND 421 SERIES (EXTRUSION PROFILE 1025)



Extruded Heat Sinks

EXTRUDED HEAT SINKS FOR POWER SEMICONDUCTORS

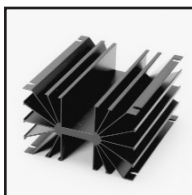

431 & 433 SERIES

High-Performance Heat Sinks for 30-100W Metal Power Semiconductors

TO-3; Stud-Mount

Standard P/N	Width in. (mm)	Nominal Dimensions		Semiconductor Mounting Hole Pattern	Thermal Performance at Typical Load		Weight lbs. (grams)
		Length "A" in. (mm)	Height in. (mm)		Natural Convection	Forced Convection	
431K	4.750 (120.7)	3.000 (76.2)	3.000 (76.2)	None	55°C @ 50W	0.40°C/W @ 250 LFM	0.7800 (353.81)
433K	4.750 (120.7)	5.500 (139.7)	3.000 (76.2)	None	42°C @ 50W	0.28°C/W @ 250 LFM	1.4900 (675.86)

Need maximum heat dissipation from a TO-3 rectifier heat sink in minimum space? The Wakefield 431 and 433 Series center channel double-surface heat sinks offer the highest performance-to-weight ratio for minimum volume occupied for TO-3, diode, and stud-mount metal power semiconductors in the 30- to

100-watt operating range. Additional interface resistance reduction for maximized overall performance can be achieved with proper application of Wakefield Type 126 silicone-free thermal compound. Material: Aluminum Alloy, Black Anodized.

MECHANICAL DIMENSIONS

Dimensions: in. (mm)

NATURAL AND FORCED CONVECTION CHARACTERISTICS

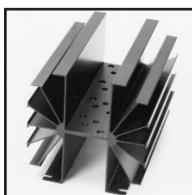

435 SERIES

Lightweight Quadruple Mount Heat Sink for TO-3 Case Styles

TO-3

Standard P/N	Width in. (mm)	Nominal Dimensions		Semiconductor Mounting Hole Pattern	Thermal Performance at Typical Load		Weight lbs. (grams)
		Length in. (mm)	Height in. (mm)		Natural Convection	Forced Convection	
435AAAA	4.250 (108.0)	5.500 (139.7)	4.300 (109.2)	(4) TO-3	37°C @ 50W 54°C @ 80W	0.38°C/W @ 250 LFM 0.24°C/W @ 600 LFM	1.1500 (521.64)

This lightweight high-performance heat sink is designed to mount and cool efficiently one to four TO-3 style metal case power semiconductors. The Type 435AAAA is the standard configuration available from stock, predrilled for mounting four TO-3 style devices. Increased performance can be achieved with the proper

selection and installation of a Wakefield Type 175 DeltaPad Kapton™ interface material for each power semiconductor or, for maximum reduction of case-to-sink interface loss, the application of Wakefield Type 126 silicone-free thermal compound. Material: Aluminum Alloy, Black Anodized.

MECHANICAL DIMENSIONS

Dimensions: in. (mm)

NATURAL AND FORCED CONVECTION CHARACTERISTICS

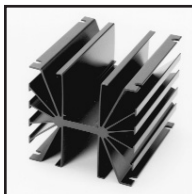

441 SERIES

High-Performance Natural Convection Heat Sinks for Rectifiers and Diodes

Stud-Mount

Standard P/N	Width in. (mm)	Nominal Dimensions		Semiconductor Mounting Hole Pattern	Thermal Performance at Typical Load		Weight lbs. (grams)
		Length in. (mm)	Height in. (mm)		Natural Convection	Forced Convection	
441K	4.750 (120.7)	5.500 (139.7)	4.500 (114.3)	None	34°C @ SOW 47°C @ 80W	0.30°C/W @ 250 LFM 0.19°C/W @ 600 LFM	1.9700 (893.59)

Designed for vertical mounting within a power supply enclosure or equipment cabinet without forced airflow available. This Wakefield 441 Series heat sink will dissipate up to 100 watts efficiently in natural convection with a maximum 55°C heat sink temperature rise above ambient. When applied in a forced convec-

tion environment, the 441K Type will achieve thermal resistance of 0.18°C/W (sink to ambient) at 1000 LFM. Supplied with no predrilled device mounting hole pattern. Material: Aluminum Alloy, Black Anodized.

MECHANICAL DIMENSIONS

Dimensions: in. (mm)

NATURAL AND FORCED CONVECTION CHARACTERISTICS

Extruded Heat Sinks



EXTRUDED HEAT SINKS FOR POWER SEMICONDUCTORS

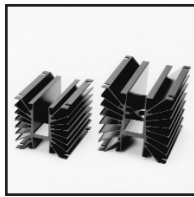

465 & 476 SERIES

High-Power Heat Sinks for Medium Hex-Type Rectifiers and Diodes

Stud-Mount

Standard P/N	Width in. (mm)	Nominal Dimensions			Hex Style Type	Mounting Hole Pattern	Thermal Performance at Typical Load		Weight lbs. (grams)
		Length in. (mm)	Height in. (mm)	Natural Convection			Forced Convection		
465K	4.000 (101.6)	5.000 (127.0)	4.000 (101.6)	1.060 in. Hex	None	38°C @ 50W	0.27°C/W @ 500 LFM	1.9300 (875.45)	
476K	5.000 (127.0)	6.000 (152.4)	5.000 (127.0)	1.250 in. Hex	None	25°C @ 50W	0.19°C/W @ 500 LFM	2.8200 (1279.15)	
476W	5.000 (127.0)	6.000 (152.4)	5.000 (127.0)	1.250 in. Hex	0.765 in. (19.4) Dia. Center Mount	25°C @ 50W	0.19°C/W @ 500 LFM	2.8000 (1270.08)	

Wakefield Engineering has designed four standard heat sink types for ease of installation and efficient heat dissipation for industry standard hex-type rectifiers and similar stud-mount power devices: 465, 476, 486, and 489 Series. The 465 and 476 Series shown here are de-

signed for 1.060 in. Hex (465 Type) and 1.250 in. Hex (476 Type). The 476W Type is available predrilled for an 0.765 in. (19.4) dia, mounting hole, Material: Aluminum Alloy, Black anodized.

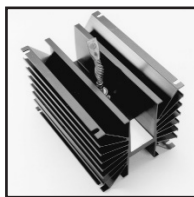
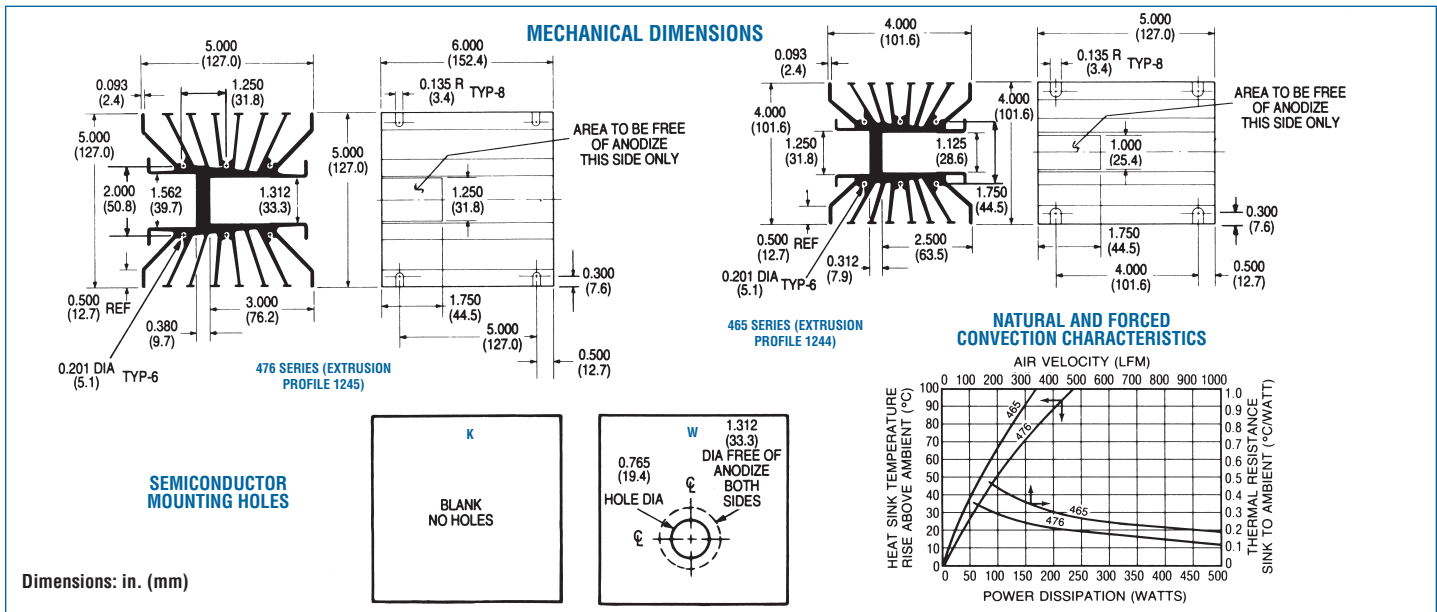

486 & 489 SERIES

Heat Sinks for High-Power Hex-Type Rectifiers and Diodes

Stud-Mount

Standard P/N	Width in. (mm)	Nominal Dimensions			Hex Style Type	Mounting Hole Pattern	Thermal Performance at Typical Load		Weight lbs. (grams)
		Length in. (mm)	Height in. (mm)	Natural Convection			Forced Convection		
486K	6.250 (158.8)	6.000 (152.4)	6.250 (158.8)	1.750 in. Hex	None	24°C @ 50W	0.20°C/W @ 250 LFM	4.2100 (1909.66)	
489K	6.250 (158.8)	9.000 (228.6)	6.250 (158.8)	1.750 in. Hex	None	86°C @ 250W	0.13°C/W @ 500 LFM	6.1400 (2785.10)	
						19°C @ 50W	0.15°C/W @ 250 LFM		
						75°C @ 250W	0.10°C/W @ 500 LFM		

These two heat sink types accept industry standard 1.750 in. (44.5) hex-type devices for mounting and efficient heat dissipation. Each type is provided with a 1.750 in. (44.5) x 2.000

in. (50.8) area on the semiconductor base mounting surface which is free of anodize. Material: Aluminum Alloy, Black Anodized.

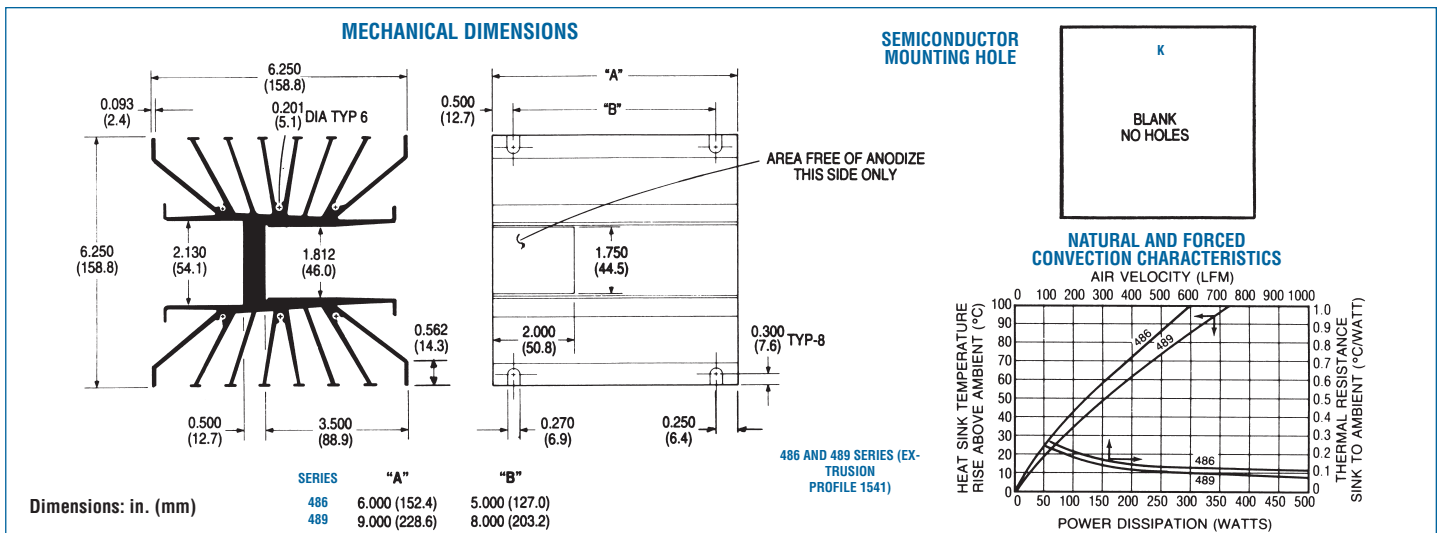



Extruded Heat Sinks

EXTRUDED HEAT SINKS FOR POWER SEMICONDUCTORS



490 SERIES King Size Heat Sinks for High-Power Rectifiers

GENERAL PURPOSE

Standard P/N	Width in. (mm)	Nominal Dimensions		Semiconductor Mounting Hole Pattern	Thermal Performance at Typical Load		Weight lbs. (grams)
		Length "A" in. (mm)	Height in. (mm)		Natural Convection	Forced Convection	
490-35K	9.250 (235.0)	3.500 (88.9)	6.750 (171.5)	None	84°C @ 200W	0.18°C/W @ 600 LFM	3.2400 (1469.66)
490-6K	9.250 (235.0)	6.000 (152.4)	6.750 (171.5)	None	60°C @ 200W	0.13°C/W @ 600 LFM	5.4700 (2481.19)
490-12K	9.250 (235.0)	12.000 (304.8)	6.750 (171.5)	None	45°C @ 200W	0.09°C/W @ 600 LFM	10.6200 (4817.23)

The 490 Series can be used to mount a single high-power rectifier or a grouping of smaller power devices. The semiconductor device mounting surface is free of anodize on the entire surface on one side only; finish overall is black anodize. Use Type 109 mounting brackets (see accessories section) for mounting to enclosure wall and for electrical isolation. The anodize-

free mounting surface is milled for maximum contact area. The 490 Series Can also be drilled for mounting and cooling IGBTs and other isolated power modules. Material: Aluminum Alloy, Black Anodized.

MECHANICAL DIMENSIONS

490 SERIES (EXTRUSION PROFILE 2131)

Dimensions: in. (mm)

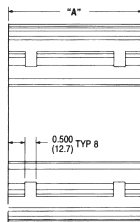
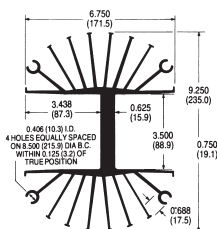

SEMICONDUCTOR MOUNTING HOLE

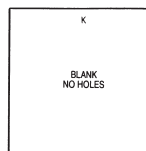

NATURAL AND FORCED CONVECTION CHARACTERISTICS

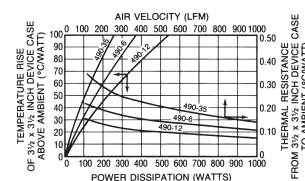

PERFORMANCE, LOW PROFILE HEAT SINKS FOR POWER MODULES & IGBT'S

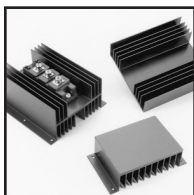

394, 395, 396 SERIES

Standard P/N	Overall Dimensions: in. (mm)			Device Base Mounting Area (mm)	Base Mounting Holes	Thermal Resistance at Typical Load	
	Length in. (mm)	Height in. (mm)	Width in. (mm)			Natural Convection (θ _{sa}) ⁽¹⁾ (°C/W)	Forced Convection (θ _{sa}) (°C/W @ 500 LFM)
394-1AB	3.000 (76.2)	1.500 (38.1)	5.000 (127.0)	101 x 76	4	1.85	0.90
394-2AB	5.500 (139.7)	1.500 (38.1)	5.000 (127.0)	101 x 139	6	1.51	0.60
395-1AB	3.000 (76.2)	2.500 (63.5)	5.000 (127.0)	50 x 76	4	1.10	0.50
395-2AB	5.500 (139.7)	2.500 (63.5)	5.000 (127.0)	50 x 139	6	0.90	0.32
396-1AB	3.000 (76.2)	1.380 (35.1)	5.000 (127.0)	50 x 76	4	1.85	1.07
396-2AB	5.500 (139.7)	1.380 (35.1)	5.000 (127.0)	50 x 139	6	1.51	0.64

Note: 1. Thermal resistance values shown are for black anodized finish at 50°C rise above ambient.

MECHANICAL DIMENSIONS

394 SERIES (EXTRUSION PROFILE 7332)

Weight 1.71 lb/ft

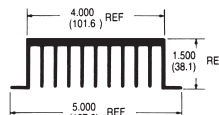
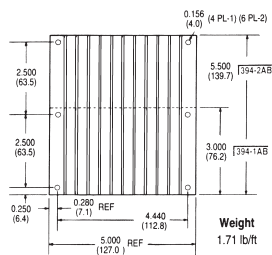

NATURAL AND FORCED CONVECTION CHARACTERISTICS

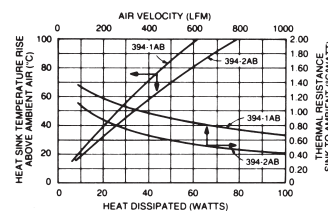

395 SERIES (EXTRUSION PROFILE 7330)

Weight 2.55 lb/ft

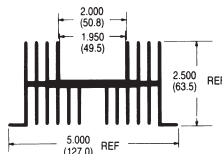
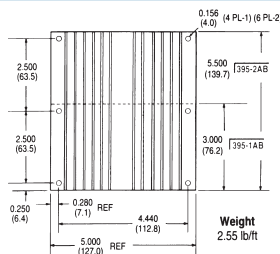

NATURAL AND FORCED CONVECTION CHARACTERISTICS

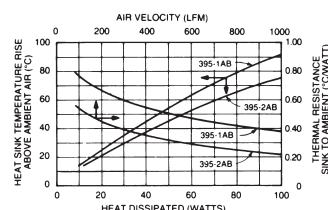

396 SERIES (EXTRUSION PROFILE 7331)

Weight 1.90 lb/ft

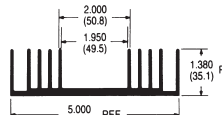
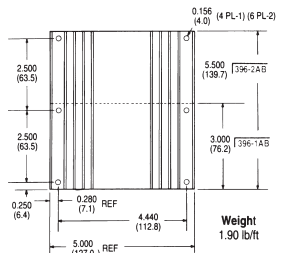

NATURAL AND FORCED CONVECTION CHARACTERISTICS

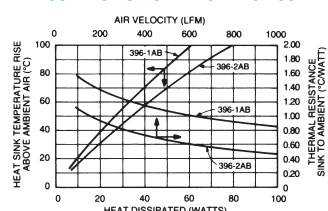

Dimensions: in. (mm)

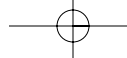

Extruded Heat Sinks wakefield-vette

EXTRUDED HEAT SINKS FOR DC/DC CONVERTERS

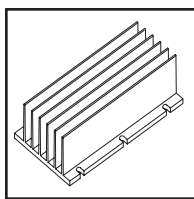

SERIES 557, 558 & 559 Heat Sinks for "Full-Brick" DC/DC Converters

Standard P/N	Footprint Dimensions in. (mm)	Height in. (mm)	Fin Orientation	Number of Fins	Forced Convection Thermal Resistance at 300 ft/min (C/W)	Natural Convection Power Dissipation (Watts) 40°C Rise Heat Sink to Ambient
557-140AB	4.60 (116.8) x 2.40 (61.0)	1.40 (35.6)	Horizontal	6	1.3	14
558-75AB	2.40 (61.0) x 4.60 (116.8)	0.75 (19.1)	Vertical	16	1.8	12
559-50AB	2.40 (61.0) x 4.60 (116.8)	0.50 (12.7)	Vertical	27	2.2	10

Material: Aluminum, Black Anodized

- Standard mounting hole pattern mates with Vicor DC/DC converters.
- Aluminum extruded fin construction keeps DC/DC converter modules cool in both forced and natural convection applications.
- Three fin heights, two flow direction options.
- Black anodized finish standard.
- Integral thermal interface pad option eliminates need to order and install pad separately.
- Ordering a single part number with the hardware kit option provides everything necessary to keep your converter cool.

MECHANICAL DIMENSIONS

PRODUCT DESIGNATION

SERIES 557 -140 - AB - MS4

SERIES NUMBER: 557
HEIGHT: 140 = 1.40"
MATERIAL: A = ALUMINUM
FINISH: B = BLACK ANODIZE

THERMAL INTERFACE TYPE:
S4 = DELTALINK IV
BLANK = NO THERMAL PAD

HARDWARE KIT	QTY
M = M3 X 8mm PHILLIPS HD SEM SCREW, WITH CAPTIVE WASHER	6
H = 4-40 X 5/16" PHILLIPS HD SEM SCREW, WITH CAPTIVE WASHER	6
BLANK = NO FASTENER OPTION	0

557 SERIES DIMENSIONS

MECHANICAL DIMENSIONS

PRODUCT DESIGNATION

SERIES 558 -75 - AB - MS4

SERIES NUMBER: 558
HEIGHT: 75 = .75"
MATERIAL: A = ALUMINUM
FINISH: B = BLACK ANODIZE

THERMAL INTERFACE TYPE:
S4 = DELTALINK IV
BLANK = NO THERMAL PAD

HARDWARE KIT	QTY
M = M3 X 8mm PHILLIPS HD SEM SCREW, WITH CAPTIVE WASHER	6
H = 4-40 X 5/16" PHILLIPS HD SEM SCREW, WITH CAPTIVE WASHER	6
BLANK = NO FASTENER OPTION	0

558 SERIES DIMENSIONS

MECHANICAL DIMENSIONS

PRODUCT DESIGNATION

SERIES 559 -50 - AB - MS4

SERIES NUMBER: 559
HEIGHT: 50 = .50"
MATERIAL: A = ALUMINUM
FINISH: B = BLACK ANODIZE

THERMAL INTERFACE TYPE:
S4 = DELTALINK IV
BLANK = NO THERMAL PAD

HARDWARE KIT	QTY
M = M3 X 8mm PHILLIPS HD SEM SCREW, WITH CAPTIVE WASHER	6
H = 4-40 X 5/16" PHILLIPS HD SEM SCREW, WITH CAPTIVE WASHER	6
BLANK = NO FASTENER OPTION	0

559 SERIES DIMENSIONS

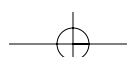



Extruded Heat Sinks

EXTRUDED HEAT SINKS FOR DC/DC CONVERTERS

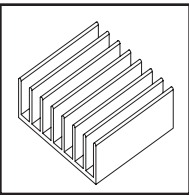

SERIES 517, 527, 518 & 528

Heat Sinks for "Half-Brick" DC/DC Converters

Standard P/N	Footprint Dimensions in. (mm)	Height in. (mm)	Fin Orientation	Number of Fins	THERMAL PERFORMANCE	
					Natural Convection Power Dissipation (Watts) 60°C Rise Heat Sink to Ambient	Forced Convection Thermal Resistance at 300 ft/min (C/W)
517-95AB	2.28 (57.9) x 2.40 (61.0)	0.95 (24.1)	Horizontal	8	11W	2.1
527-45AB	2.28 (57.9) x 2.40 (61.0)	0.45 (11.4)	Horizontal	11	7W	2.3
527-24AB	2.28 (57.9) x 2.40 (61.0)	0.24 (6.1)	Horizontal	11	5W	4.2
518-95AB	2.40 (61.0) x 2.28 (57.9)	0.95 (24.1)	Vertical	8	11W	2.2
528-45AB	2.40 (61.0) x 2.28 (57.9)	0.45 (11.4)	Vertical	11	7W	2.1
528-24AB	2.40 (61.0) x 2.28 (57.9)	0.24 (6.1)	Vertical	11	5W	3.5

Material: Aluminum, Black Anodized

• Standard mounting hole patterns mate with the majority of "half-brick" DC/DC converters on the market. • Aluminum extruded fin construction keeps DC/DC converter modules cool in both forced and natural convection applications. • Vertical and horizontal fin configurations

available in a variety of heights. • Black anodized finish standard. • Integral thermal interface pad option eliminates need to order and install pad separately. • Ordering a single part number with the hardware kit option provides everything necessary to keep your converter cool.

MECHANICAL DIMENSIONS

517, 527, 518 AND 528 SERIES

517/527 SERIES DIMENSIONS

518/528 SERIES DIMENSIONS

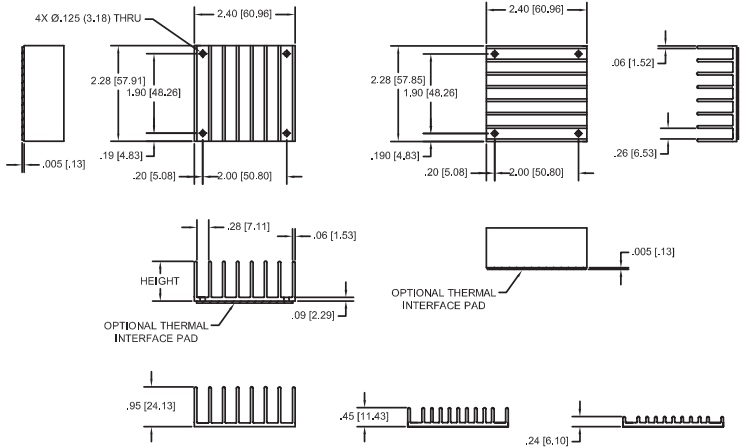
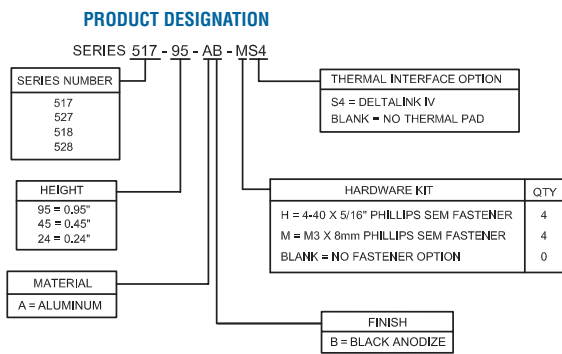

Dimensions: in. (mm)

MOUNTING HARDWARE FOR EXTRUDED HEAT SINKS

100 SERIES Teflon Mounting Insulators

Standard P/N	Description	For Use with Series	Mounting Hardware	Material	Hipot Rating (VAC)	Weight lbs. (grams)
103	Spool-shaped insulator	300, 400, 600, 111, 113	#6-32 screw	Teflon	1500	0.00012 (0.05)
107	Spool-shaped insulator	300, 400, 600, 111, 113	#6-32 screw, nut	Teflon	5000	0.0034 (1.54)

103 SERIES

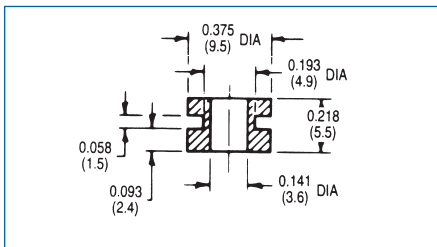

107 SERIES

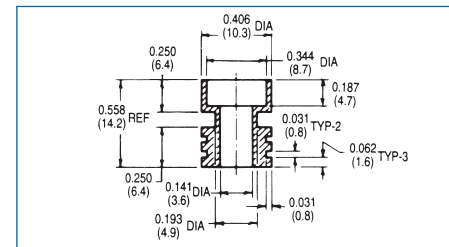
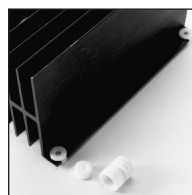

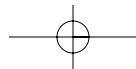

Extruded Heat Sinks



EXTRUDED HEAT SINKS FOR DC/DC CONVERTERS

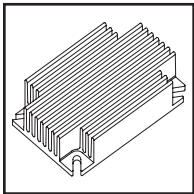

537 & 547 SERIES

Heat Sinks for "Quarter-Brick" DC/DC Converters

Standard P/N	Footprint Dimensions in. (mm)	Height in. (mm)	Fin Orientation	Number of Fins	Forced Convection Thermal Resistance at 300 ft/min (C/W)
537-95AB	2.28 (57.9) x 1.45 (36.8)	0.95 (24.1)	Horizontal	8	2.1
537-45AB	2.28 (57.9) x 1.45 (36.8)	0.45 (11.4)	Horizontal	13	2.3
537-24AB	2.28 (57.9) x 1.45 (36.8)	0.24 (6.1)	Horizontal	14	4.2
547-95AB	1.45 (36.8) x 2.28 (57.9)	0.95 (24.1)	Vertical	11	2.2
547-45AB	1.45 (36.8) x 2.28 (57.9)	0.45 (11.4)	Vertical	20	2.1
547-24AB	1.45 (36.8) x 2.28 (57.9)	0.24 (6.1)	Vertical	22	3.5

Material: Aluminum, Black Anodized

• Mounting slots accommodate two hole patterns: 1.86" x 1.03" and 2.00" x 1.20", fitting the vast majority of quarter-brick converters on the market. • Designed for optimum use in forced convection applications. • Vertical and horizontal fin configurations available in a variety of

heights. • Black anodized finish standard. • Integral thermal interface pad option eliminates need to order and install pad separately. • Ordering a single part number with the hardware kit option provides everything necessary to keep your converter cool.

MECHANICAL DIMENSIONS

537 & 547 SERIES

537 SERIES DIMENSIONS

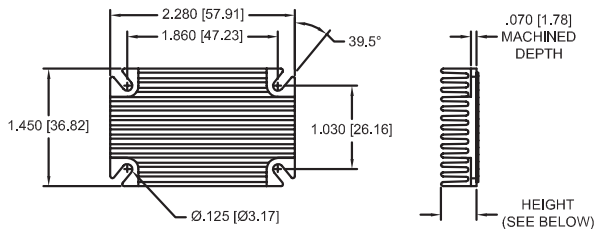

547 SERIES DIMENSIONS

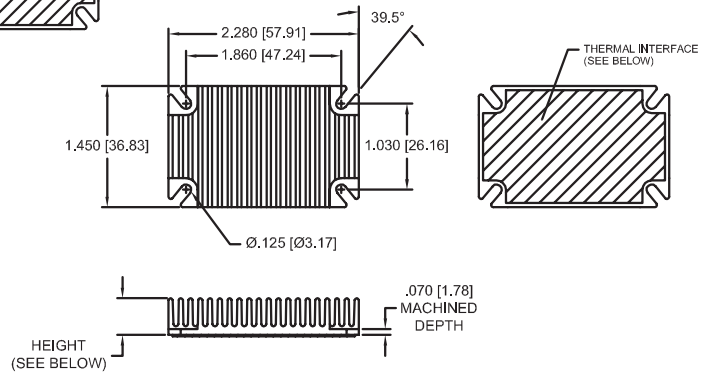

PRODUCT DESIGNATION

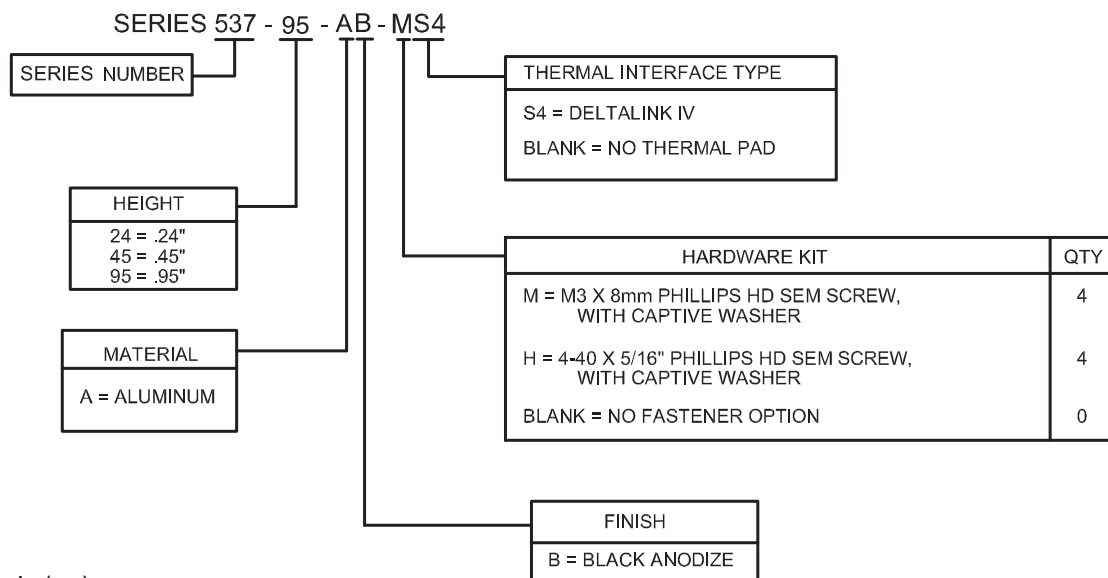

Dimensions: in. (mm)

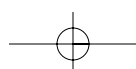



Bonded Fin Heat Sinks

HIGH FIN DENSITY HEAT SINKS FOR POWER MODULES, IGBTs, RELAYS

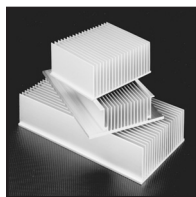

510, 511 & 512 SERIES

Standard Catalog P/N ⁽⁶⁾ Milled Base ⁽¹⁾	Nonmilled Base ⁽²⁾	Base Width in. (mm)	Length in. (mm)	Height Milled Base ⁽¹⁾ ("M Series") in. (mm)	Nonmilled Base ⁽²⁾ ("U" Series) in. (mm)	Thermal Resistance ⁽⁵⁾ (θ_{sa}) at Typical Load	
						Natural Convection ⁽³⁾ (°C/W)	Forced Convection ⁽⁴⁾ (°C/W @ 100 CFM)
510-3M	510-3U	7.380 (187.452)	3.000 (76.2)	3.106 (78.9)	3.136 (79.7)	0.56	0.088
510-6M	510-6U	7.380 (187.452)	6.000 (152.4)	3.106 (78.9)	3.136 (79.7)	0.38	0.070
510-9M	510-9U	7.380 (187.452)	9.000 (228.6)	3.106 (78.9)	3.136 (79.7)	0.29	0.066
510-12M	510-12U	7.380 (187.452)	12.000 (304.8)	3.106 (78.9)	3.136 (79.7)	0.24	0.062
510-14M	510-14U	7.380 (187.452)	14.000 (355.6)	3.106 (78.9)	3.136 (79.7)	0.21	0.059
511-3M	511-3U	5.210 (132.33)	3.000 (76.2)	2.350 (59.7)	2.410 (61.2)	0.90	0.120
511-6M	511-6U	5.210 (132.33)	6.000 (152.4)	2.350 (59.7)	2.410 (61.2)	0.65	0.068
511-9M	511-9U	5.210 (132.33)	9.000 (228.6)	2.350 (59.7)	2.410 (61.2)	0.56	0.060
511-12M	511-12U	5.210 (132.33)	12.000 (304.8)	2.350 (59.7)	2.410 (61.2)	0.45	0.045
512-3M	512-3U	7.200 (182.88)	3.000 (76.2)	2.350 (59.7)	2.410 (61.2)	0.90	0.120
512-6M	512-6U	7.200 (182.88)	6.000 (152.4)	2.350 (59.7)	2.410 (61.2)	0.65	0.068
512-9M	512-9U	7.200 (182.88)	9.000 (228.6)	2.350 (59.7)	2.410 (61.2)	0.56	0.060
512-12M	512-12U	7.200 (182.88)	12.000 (304.8)	2.350 (59.7)	2.410 (61.2)	0.45	0.045

- Notes:**
1. Precision-milled base for maximum heat transfer performance (flatness 0.002 in./in.)
 2. Nonmilled base flatness: 0.006 in./in.
 3. Natural convection heat dissipation for distributed heat sources at 50°C rise.
 4. Forced convection heat dissipation for distributed heat sources at 100 cubic feet per minute, shrouded condition.
 5. Standard models are provided without finish.

MECHANICAL DIMENSIONS

510 SERIES

510 Series (Extrusion Profile 5113)

Series	A	B	Flatness
510-U	0.216 (5.5)	3.136 (79.7)	0.006 in./in. (0.15 mm/mm)
510-M	0.165 (4.2)	3.106 (78.9)	0.002 in./in. (0.05 mm/mm)

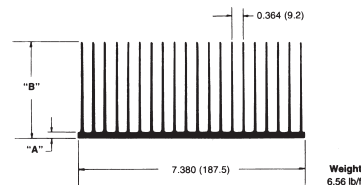

NATURAL AND FORCED CONVECTION CHARACTERISTICS

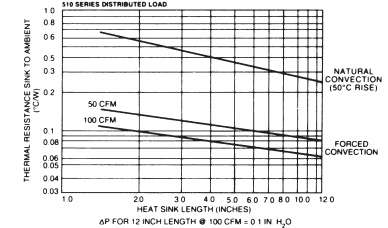

511 AND 512 SERIES

511 Series (Extrusion Profile 6438-1) 512 Series (Extrusion Profile 6438-2)

Series	A	B	C	Flatness
511-U 512-U	0.250 (6.4)	2.410 (61.2)	0.372 (9.4)	0.006 in./in. (0.15 mm/mm)
511-M 512-M	0.220 (5.6)	2.350 (59.7)	0.342 (8.7)	0.002 in./in. (0.05 mm/mm)

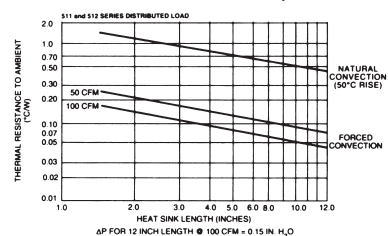
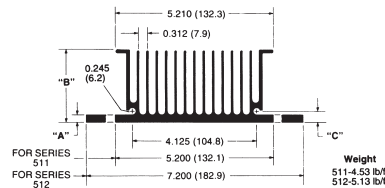

Dimensions: in. (mm)

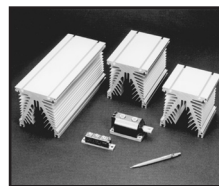

392 SERIES

High Performance Heat Sinks for Power Modules, IGBTs and Solid State Relays

Standard P/N, Finish Black Anodized	Gold Iridite	Length in. (mm)	Thermal Resistance at Typical Load		Weight lbs. (grams)
			Natural Convection (θ_{sa}) (°CW)	Forced Convection (θ_{sa}) (°CW)	
392-120AB	392-120AG	4.725 (120.0)	0.50	0.16 @ 100 CFM	4.452 (2019.43)
392-180AB	392-180AG	7.087 (180.0)	0.43	0.11 @ 100 CFM	6.636 (3010.09)
392-300AB	392-300AG	11.811 (300.0)	0.33	0.08 @ 100 CFM	10.420 (4726.51)

MECHANICAL DIMENSIONS

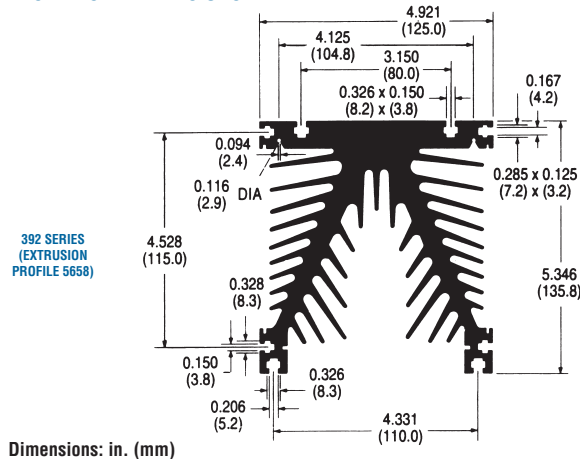

Dimensions: in. (mm)

NATURAL AND FORCED CONVECTION CHARACTERISTICS

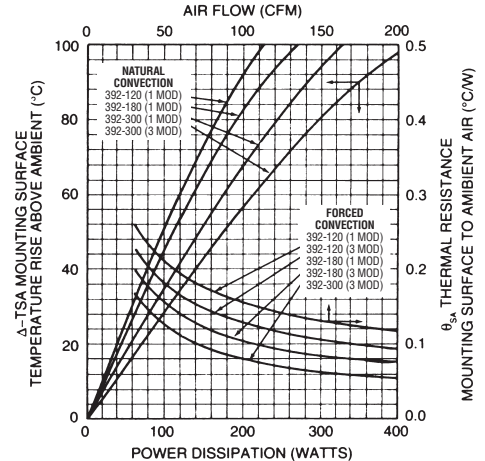

X-ON Electronics

Largest Supplier of Electrical and Electronic Components

Click to view similar products for [Heat Sinks](#) category:

Click to view products by [Wakefield](#) manufacturer:

Other Similar products are found below :

[657-20ABPNE](#) [73452PPBA](#) [A22-4026](#) [120-1873-007](#) [218-40CTE3](#) [231-69PAB-15V](#) [231-75PAB-13V](#) [231-75PAB-15V](#) [253-122ABE-22](#)
[PSC22CB](#) [295-2](#) [CLP212SG](#) [D10100-28](#) [BDN183CBA01](#) [3-21053-4](#) [TX0506-1B](#) [LAE66A3CB](#) [511-3U](#) [73381PPBA](#) [73403PPBA](#) [8191-](#)
[E40](#) [510-12M](#) [529802B00000](#) [D10650-40T5](#) [6225B-MT6G](#) [ATS-54310K-C2-R0](#) [648-51AB](#) [657-20ABPESC](#) [679-25AG](#) [FK 212 CB SA](#)
[FK225 SA L1](#) [241404B91203G](#) [6801G](#) [680-5K](#) [7106DG/TR](#) [SK145 37 5STSTO220](#) [7109DG/TR](#) [TS-11042-CY](#) [S14K35G3S5](#) [8924G](#)
[7717-133DAP](#) [7717-26DAP](#) [4509](#) [SW25-4G](#) [CLP-215](#) [CLP-207](#) [D20850-40-T2](#) [APF30-30-10CB/A01](#) [V8508E](#) [268-85CTE](#)