

678-39-S & 678-39-C

Part Number	Description	Length	Width	Thermal Resistance @ Forced Air Flow
678-39-S	Universal Heat Sink for TO Devices w/Screw Hole, Black Anodize	1.520" (38.61mm)	2.362" (60.00mm)	0.6°C/W @ 600 LFM
678-39-C	Universal Heat Sink for TO Devices w/ Clip, Black Anodize	1.520" (38.61mm)	2.362" (60.00mm)	0.6°C/W @ 600 LFM



Wakefield-Vette introduces **Universal 678 series**, high performance, low cost and versatile heat sink with screw or clip for all kinds of standard packages. This type of heat sink provides both vertical and horizontal mounting options on PCB to accommodate natural and forced convection cooling method.

SPECIFICATIONS

- Heat Sink: Aluminum Alloy 6063-T5 or Equivalent with either degressed or black anodized finish
- Spring Clip: Music Wire, Per ASTM A228 with bright nickel plating
- Solder Foot: Cold-rolled Steel, Per ASTM A-366 with pure tin over copper strike. RoHS compliant.
- Insulator (Optional): t-Global H48-1, L37-3F and H48-6S. The thickness of the insulating material not to exceed 10 mil (0.01”).

FEATURES AND BENIFITS

Minimum assembly cost and labor- Spring Clips make the mounting holes and fasteners obsolete in assembly operations & reduce costs.

Design Flexibility- Universal mountable and “one fits all” give designers total freedom to fit their packaging designs with ideal device pak style and to orient the heat sink to meet their power dissipations with optimized cooling method. (see page 2 of data sheet)

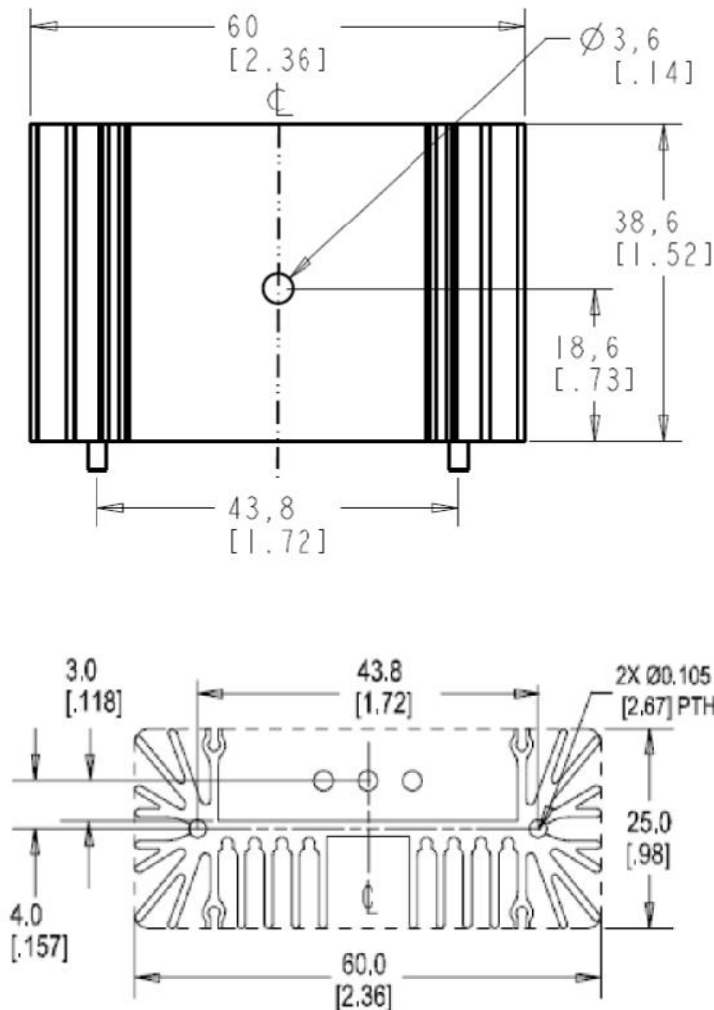

THERMAL PERFORMANCE

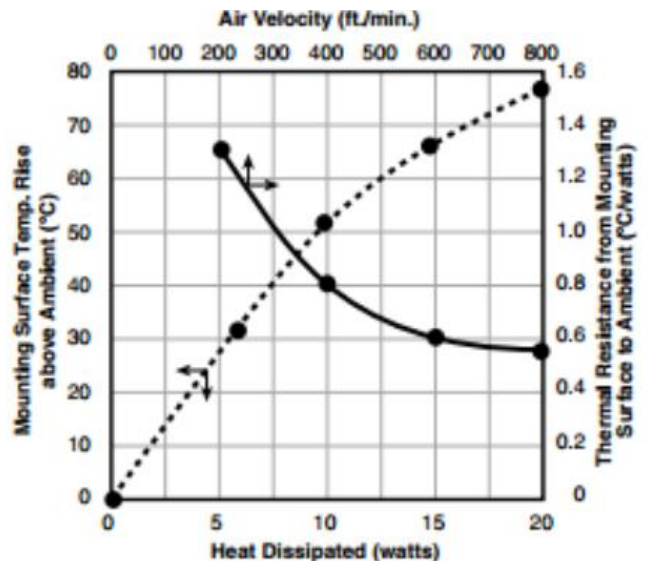

678-39-S & 678-39-C

Part Number	Description	Length	Width	Thermal Resistance @ Forced Air Flow
678-39-S	Universal Heat Sink for TO Devices w/Screw Hole, Black Anodize	1.520" (38.61mm)	2.362" (60.00mm)	0.6°C/W @ 600 LFM
678-39-C	Universal Heat Sink for TO Devices w/ Clip, Black Anodize	1.520" (38.61mm)	2.362" (60.00mm)	0.6°C/W @ 600 LFM

One Heat Sink for all Packages

SOT-227 Package

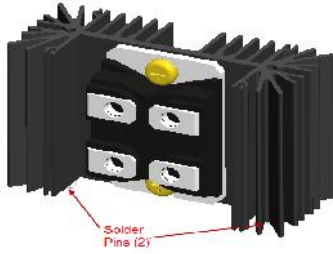

- **System level** – 2 screws
- **Natural convection** – Vertical

CPC40055ST Package

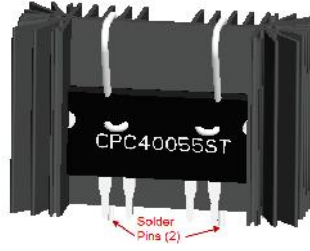

- **Board level** – 2 solder pins
- **Natural convection** – Vertical
- **Spring Clip**

CPC1998J Package

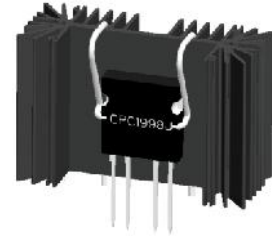

- **Board level** – 2 solder pins
- **Natural convection** – Vertical
- **Spring Clip**

CPC1968 and TO-264 Package

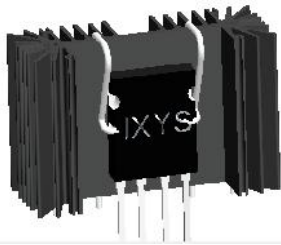

- **Board level** – 2 solder pins
- **Natural convection** – Vertical
- **Spring Clip**

L4970A Package

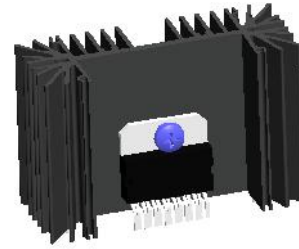

- **Board level** – 2 solder pins
- **Natural convection** – Vertical
- **Screw attachment**

KBU Package

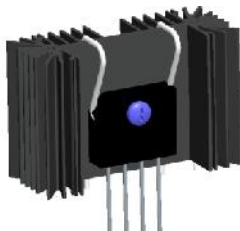

- **Board level** – 2 solder pins
- **Natural convection** – Vertical
- **Screw attachment or Spring Clip**

TO-247 and TO-220 Package

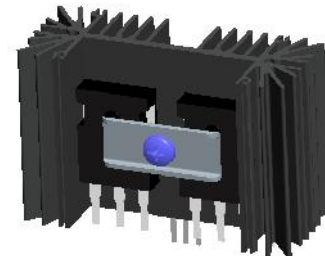

- **Board level** – 2 solder pins
- **Natural convection** – Vertical
- **Screw attachment or Spring Clip**

X-ON Electronics

Largest Supplier of Electrical and Electronic Components

Click to view similar products for [Heat Sinks](#) category:

Click to view products by [Wakefield](#) manufacturer:

Other Similar products are found below :

[581102B00000G](#) [656-15ABPE](#) [657-20ABPNE](#) [7020B-TC12-MTG](#) [73452PPBA](#) [7G0011A](#) [PF720G](#) [A22-4026](#) [120-1873-007](#) [HAH10L](#)
[HAH15L](#) [1542616-1](#) [HS-2506-F1](#) [HS-87M0-F2](#) [218-40CTE3](#) [231-69PAB-15V](#) [25-7520](#) [SW50-4G](#) [231-75PAB-13V](#) [231-75PAB-15V](#) [253-](#)
[122ABE-22](#) [PSC22CB](#) [HAF10L](#) [HAQ10T](#) [D10100-28](#) [BDN183CBA01](#) [3-21053-4](#) [32438](#) [TX0506-1B](#) [TX1806B](#) [LAE66A3CB](#) [WA-DT2-](#)
[101E](#) [511-3U](#) [73381PPBA](#) [73403PPBA](#) [7G0047C](#) [COMX-440-HSP](#) [510-12M](#) [D10650-40T5](#) [V8511 Y](#) [APF40-40-13CB/A01](#)
[780653U04500G](#) [ATS-54310K-C2-R0](#) [FK 216 CB SA](#) [FK 231 SA 220](#) [648-51AB](#) [657-20ABPESC](#) [2341BG](#) [679-25AG](#) [FK 212 CB SA](#)