

# THERMAL MANAGEMENT SOLUTIONS & THERMAL INTERFACE

*Thermal Management Solutions for BGAs* ..... 7  
*Thermal Interface* ..... 8

## BGA THERMAL SOLUTIONS MATRIX

The following table represents Wakefield-Vette's recommendations for a variety of standard BGA sizes. However, this is by no means a complete list of components that can be used with these heat sinks. To determine suitability for your particular component, request a BGA heat sink evaluation kit.

BGA Sizes (mm)	Heat Sink Footprint (mm)	Heat Sink Height (inches)	Recommended Series #	Attachment Method
17	17 x 17	.40	D10650	Adhesive
19	19 x 19	1.00	602	Adhesive
21	21 x 21	.40	D10850	Adhesive
21	21 x 21	.25 .35 .45 .60	624	Adhesive
23	22 x 22	.40 .60	604	Adhesive
23	22 x 22	.75	605	Adhesive
25	25 x 25	.25 .35 .45 .60	625	Adhesive
27	28 x 28	.25 .35 .45 .60	658	Adhesive
29	30 x 30	.77	606	Adhesive
31	31 x 28	.65	607	Adhesive
31	31 x 31	.80	611	Adhesive
33	32 x 32	.35 .40	610	Adhesive
35	35 x 35	.65	612	Adhesive
35	35 x 35	.25 .35 .45 .60	642	Adhesive
35	35 x 35	.25 .35 .45 .60	630	Adhesive
37.5	37 x 37	.50	613	Adhesive
37.5	37 x 37	.65	659	Adhesive
45.7 x 35.5	37 x 47	.80	617	Adhesive
40	38 x 38	.30 .50 1.00	614	Adhesive
37.5	38 x 38	.29	660	Adhesive
40	40 x 28	.35	643	Clip
40	40 x 40	.26 .53	655	Adhesive
42.5	41 x 41	.41	615	Adhesive
45	43 x 43	.20 .25 .35 .45 .60	628	Adhesive
45	43 x 43	.15	662	Adhesive
47.5	47 x 47	.80	616	Adhesive
50	50 x 50	.40 .65 .80 1.00	698	Adhesive
50	51 x 51	.20 1.00	618	Adhesive
50	52 x 51	.80	622	Adhesive
50	53 x 47	.40 .65 .80 1.00	798	Adhesive
50	64 x 51	.24	620	Adhesive
up to 45	73 x 50	.50 1.00	609	Clip
up to 45	73 x 50	.95	619	Clip

### RoHS COMPLIANCE

Please note that Wakefield-Vette part numbers designated with an "E" in this catalog denote new parts in compliance with the RoHS initiative, with the exception of our Precision Clamps. Wakefield-Vette will still continue to offer non-RoHS compliant versions of these parts. Please be aware that many Wakefield-Vette Standard parts have always been compliant since their design inception and therefore will not carry the "E" designation.

Wakefield-Vette requests that you refer to the RoHS compliance tool on our website at [www.wakefield-vette.com](http://www.wakefield-vette.com) to verify RoHS compliance. If you require further clarification or information regarding RoHS, please contact the factory.

## THERMAL INTERFACE MATERIAL PART NUMBER GUIDE

All of the heat sinks shown in this catalog are available with any of the following thermal tape and interface materials, pre-applied at the factory. Use the "T" series, thermally enhanced, pressure sensitive adhesives to attach the heat sink to the electronic package and provide a good thermal link to the heat sink. Specify these materials in applications where the heat sink will be fixed to the electronic package by some mechanical means other than a tape. Please note that none of these materials are for use in applications requiring electrical isolation from the electronic device. All options other than -T1 and -T4 are RoHS compliant.

**Note:** To obtain the estimated thermal resistance of the interface material in your application, divide the thermal impedance value by the area of the pad in square inches. For example, a 2" x 2" piece of T4 has a resistance of  $1.10 \text{ C-in}^2/\text{W} \div 4 \text{ in}^2 = 0.275 \text{ C/W}$

### "T" Series Thermally Enhanced Pressure Sensitive Adhesives

Suffix	Manufacturer Product	Thermal Impedance C-in <sup>2</sup> /W	Thickness, Inches	Package Surface, Comments
-T1	Chomerics, T405	0.47	0.006	Metal/ceramic; aluminum carrier
-T1E	Chomerics, T405R	0.47	0.006	RoHS-compliant version of -T1
-T3	Chomerics, T412	0.25	0.009	Metal/ceramic; very good performance and conformity
-T4	Chomerics, T410	1.10	0.007	Plastic
-T4E	Chomerics, T410R	1.10	0.007	RoHS-compliant version of -T4
-T5	Chomerics, T411	1.00	0.011	Plastic; conforms to out-of-flat packages
-T6	3M, 8810	0.88	0.010	Metal/ceramic; very good adhesion and conformity
-T7	Bergquist, BP 108	1.28	0.008	Metal/ceramic; electrically insulating

### ORDERING INFORMATION

Once you have chosen heat sink and thermal interface material that meets your thermal & mechanical requirements it is easy to designate the part number. Simply add the interface material suffix referenced on the chart above to the base part number for the heat sink. The base part number already includes information regarding its size and finish.

Example:

To order the 658 Series heat sink at .350" tall with the T5 thermal interface material, specify part number:

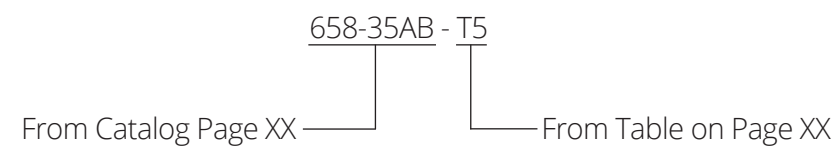

# INTEGRATED CIRCUIT COOLING HEAT SINKS

<i>Heat Sinks For BGAs, Super BGAs, &amp; FPBGAs .....</i>	<i>12-27</i>
<i>Deltem™ Composite Heat Sinks For BGAs .....</i>	<i>18</i>
<i>Heat Sinks For Microprocessors &amp; ASICs.....</i>	<i>28-30</i>
<i>Pin Fin Heat Sinks .....</i>	<i>31</i>
<i>Elliptical Fin Heat Sinks.....</i>	<i>32</i>
<i>Pin Fin &amp; Elliptical Fin Heat Sinks .....</i>	<i>33</i>
<i>Ceramic Heat Sink For To Devices w/ OmniKlip .....</i>	<i>34-35</i>
<i>Wave Series Heat Sink With Integrated Clip Assembly .....</i>	<i>36-43</i>

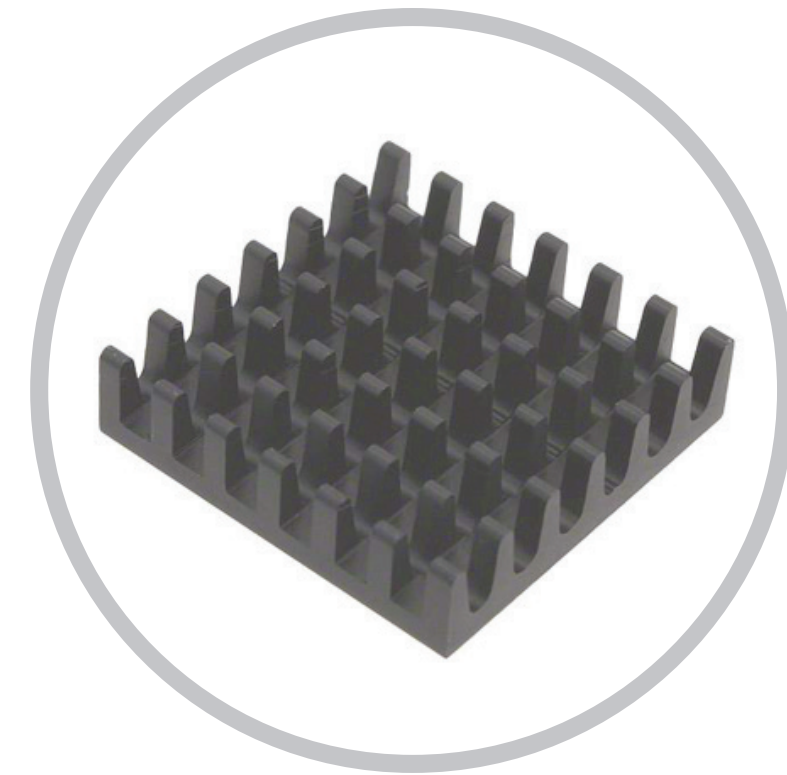

*With the increase in heat dissipation from microelectronics devices and the reduction in overall form factors, thermal management becomes a more important element of electronic product design.*

*Both the performance reliability and life expectancy of electronic equipment are inversely related to the component temperature of the equipment. The relationship between the reliability and the operating temperature of a typical silicon semi-conductor device shows that a reduction in the temperature corresponds to an exponential increase in the reliability and life expectancy of the device. Therefore, long life and reliable performance of a component may be achieved by effectively controlling the device operating temperature within the limits set by the device design engineers.*

*Heat sinks are devices that enhance heat dissipation from a hot surface, usually the case of a heat generating component, to a cooler ambient, usually air. For the following discussions, air is assumed to be the cooling fluid. In most situations, heat transfer across the interface between the solid surface and the coolant air is the least efficient within the system, and the solid-air interface represents the greatest barrier for heat dissipation. A heat sink lowers this barrier mainly by increasing the surface area that is in direct contact with the coolant. This allows more heat to be dissipated and/or lowers the device operating temperature. The primary purpose of a heat sink is to maintain the device temperature below the maximum allowable temperature specified by the device manufacturers.*

## HEAT SINKS FOR BGAs, SUPER BGAs, PBGAs, & FPBGAs

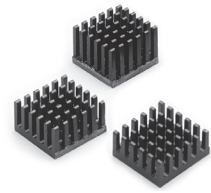

### 624 SERIES OMNIDIRECTIONAL PIN FIN HEAT SINK FOR BGAs

The **624 Series** is an omnidirectional pin fin heat sink for both natural and forced-convection applications.

Applications include network routers and switches, high-resolution printers, digital cameras, consumer video games, digital video disks (DVD) and global positioning systems (GPS).

Standard P/N	Base Dimensions in. Sq.	Fin Height "A" in. (mm)	Typical Applications	Weight lbs. (grams)
624-25AB	.827 (21)	.250 (6.4)	21mm BGA	.009 (4.09)
624-35AB	.827 (21)	.350 (8.9)	21mm BGA	.011 (4.99)
624-45AB	.827 (21)	.450 (11.4)	21mm BGA	.015 (6.81)
624-60AB	.827 (21)	.600 (15.2)	21mm BGA	.026 (11.80)

**Material:** Aluminum, Black Anodized

#### PRODUCT FEATURES

- Available in four standard heights, .25 inch, .35 inch, .45 inch, and .60 inch.
- Available with pressure sensitive adhesives for quick and easy mounting. See Page 8.

#### 624 THERMAL PERFORMANCE

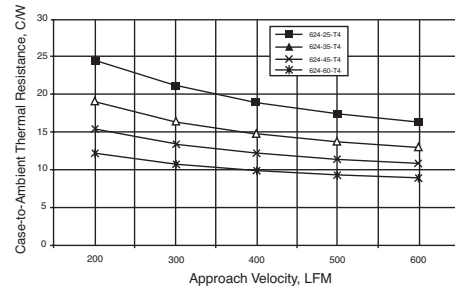

#### MECHANICAL DIMENSIONS

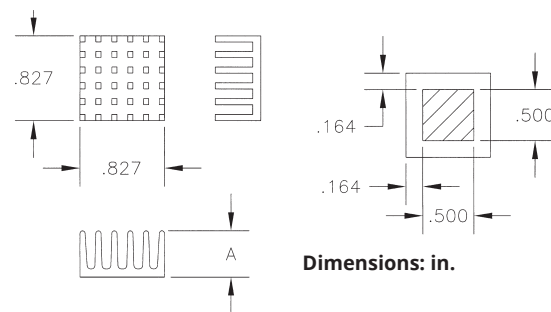

### OMNIDIRECTIONAL PIN FIN HEAT SINK FOR BGAs **625 SERIES**

#### PRODUCT FEATURES

- Available in four standard heights, .25 inch, .35 inch, .45 inch, and .60 inch.
- Available with pressure sensitive adhesives for quick and easy mounting. See Page 8.

The **625 Series** is an omnidirectional pin fin heat sink for both natural and forced-convection applications.

Applications include network routers and switches, high-resolution printers, digital cameras, consumer video games, digital video disks (DVD) and global positioning systems (GPS).

Standard P/N	Base Dimensions in. Sq.	Fin Height "A" in. (mm)	Typical Applications	Weight lbs. (grams)
625-25AB	.984 (25)	0.250 (6.4)	25 mm BGA	.012 (5.45)
625-35AB	.984 (25)	0.350 (8.9)	25 mm BGA	.014 (6.36)
625-45AB	.984 (25)	0.450 (11.4)	25 mm BGA	.018 (8.17)
625-60AB	.984 (25)	0.600 (15.2)	25 mm BGA	.030 (13.62)

**Material:** Aluminum, Black Anodized

#### 625 THERMAL PERFORMANCE

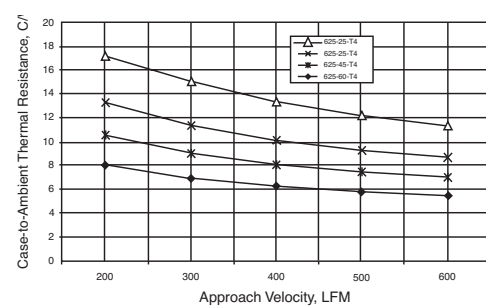

#### MECHANICAL DIMENSIONS

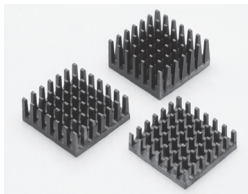
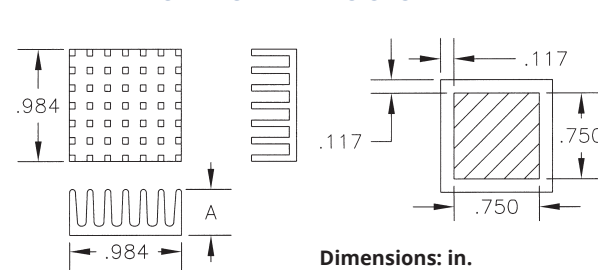

### UNIDIRECTIONAL FIN HEAT SINK FOR BGAs **659 SERIES**



Standard P/N	Base Dimensions in. (mm)	Height in. (mm)	Typical Application	Heat Sink Finish	Weight lbs. (grams)
659-65AB	1.45 (36.8) sq0	.650 (16.5)	37mm BGA	Black Anodized	0.050 (22.68)

**Notes:** 1. Optional factory pre-applied pressure-sensitive adhesive. See Page 8.

#### MECHANICAL DIMENSIONS

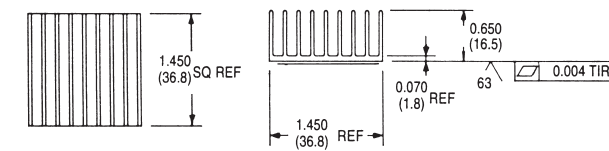

Dimensions: in. (mm)

#### NATURAL AND FORCED CONVECTION CHARACTERISTICS

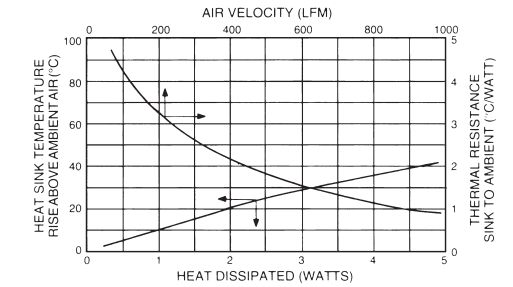

### OMNIDIRECTIONAL PIN FIN HEAT SINK FOR BGAs AND POWERPC™ **655 SERIES**

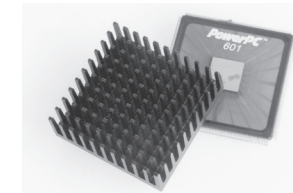

Standard P/N	Base Dimensions in. (mm)	Dimension "A" in. (mm)	Dimension "B" in. (mm)	Typical Applications	Heat Sink Finish	Weight lbs. (grams)
655-26AB	1.600 (40.6) sq	0.260 (6.6)	0.125 (3.2)	40mm BGA	Black Anodized	0.038 (17.01)
655-53AB	1.600 (40.6) sq	0.525 (13.3)	0.145 (3.7)	40mm BGA	Black Anodized	0.050 (22.68)

**Notes:** 1. Optional factory pre-applied pressure-sensitive adhesive. See Page 8.

#### MECHANICAL DIMENSIONS

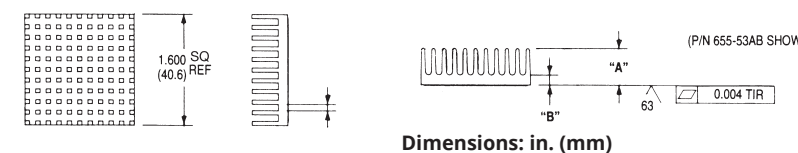

Dimensions: in. (mm)

#### NATURAL AND FORCED CONVECTION CHARACTERISTICS

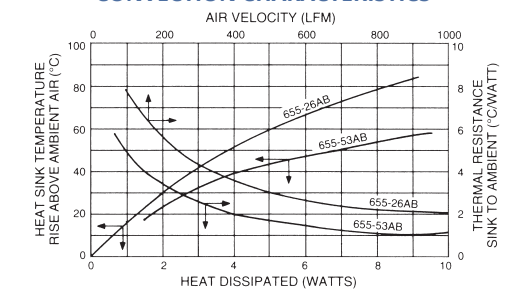

### OMNIDIRECTIONAL PIN FIN HEAT SINK FOR BGAs AND POWERPC™ **658 SERIES**

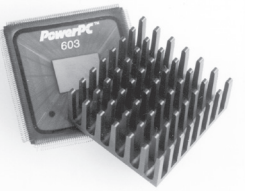

Standard P/N	Base Dimensions in. (mm)	Dimension "A" in. (mm)	Typical Applications	Heat Sink Finish	Weight lbs. (grams)
658-25AB	1.100 (27.9) sq	0.250 (6.4)	27mm BGA	Black Anodized	0.013 (5.67)
658-35AB	1.100 (27.9) sq	0.350 (8.9)	27mm BGA	Black Anodized	0.015 (6.70)
658-45AB	1.100 (27.9) sq	0.450 (11.4)	27mm BGA	Black Anodized	0.019 (8.50)
658-60AB	1.100 (27.9) sq	0.600 (15.2)	27mm BGA	Black Anodized	0.031 (14.17)

**Notes:** 1. Optional factory pre-applied pressure-sensitive adhesive. See Page 8.

#### MECHANICAL DIMENSIONS

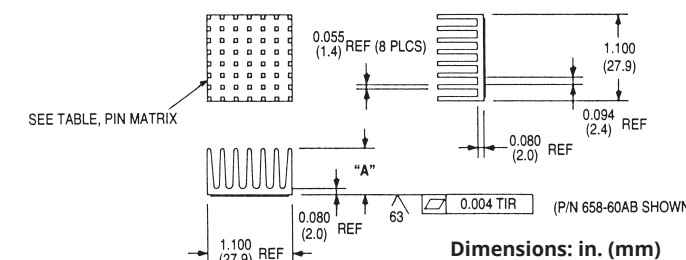

Dimensions: in. (mm)

#### NATURAL AND FORCED CONVECTION CHARACTERISTICS

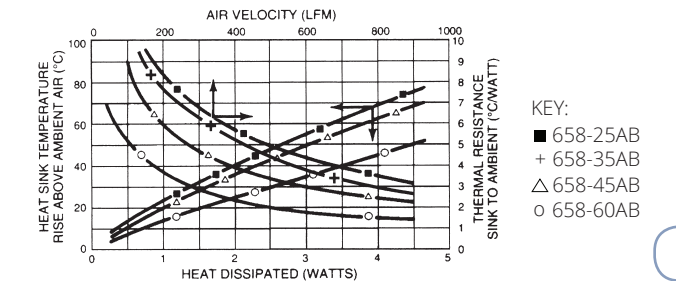

KEY:  
 ■ 658-25AB  
 + 658-35AB  
 △ 658-45AB  
 ○ 658-60AB



## HEAT SINKS FOR BGAs, SUPER BGAs, PBGAs, & FPBGAs

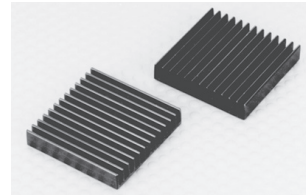

### 660 SERIES UNIDIRECTIONAL FIN HEAT SINK FOR BGAs

Standard P/N	Base Dimensions in. (mm)	Height in. (mm)	Typical Application	Heat Sink Finish	Weight lbs. (grams)
660-29AB	1.530SQ. (38.9)SQ.	0.285 (7.2)	37mm BGA	Black Anodized	0.031 (14.17)

Notes: 1. Optional factory pre-applied pressure-sensitive adhesive. See Page 8.

#### MECHANICAL DIMENSIONS

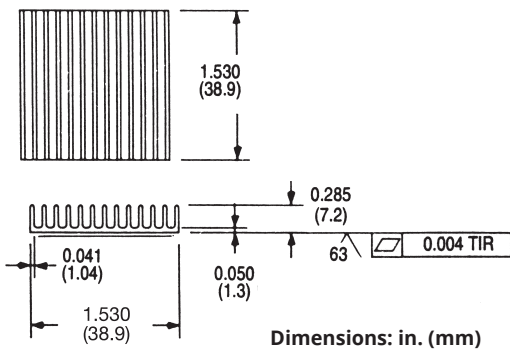

#### NATURAL AND FORCED CONVECTION CHARACTERISTICS

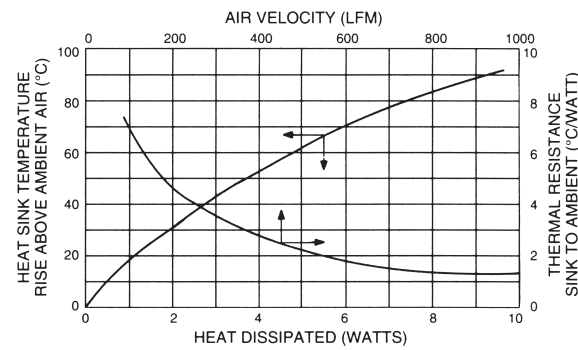

### UNIDIRECTIONAL FIN HEAT SINK FOR BGAs 642 SERIES

#### PRODUCT FEATURES

- Available in four standard heights, .25 inch, .35 inch, .45 inch, and .60 inch.
- Available with pressure sensitive adhesives for quick and easy mounting. See Page 8.

The **642 Series** is an unidirectional pin fin heat sink for both natural and forced-convection applications.

Applications include network routers and switches, high-resolution printers, digital cameras, consumer video games, digital video disks (DVD) and global positioning systems (GPS).

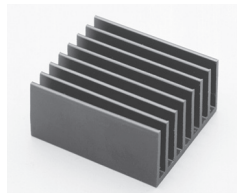

Standard P/N	Base Dimensions in. Sq.	Fin Height "A" in. (mm)	Typical Applications	Weight lbs. (grams)
642-25AB	1.378 (35)	.250 (6.4)	35 mm BGA	.022 (9.99)
642-35AB	1.378 (35)	.350 (8.9)	35 mm BGA	.027 (12.26)
642-45AB	1.378 (35)	.450 (11.4)	35 mm BGA	.031 (14.07)
642-60AB	1.378 (35)	.600 (15.2)	35 mm BGA	.039 (17.71)

Material: Aluminum, Black Anodized

#### MECHANICAL DIMENSIONS

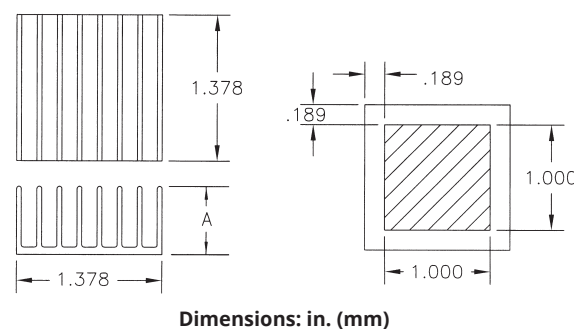

#### 642 THERMAL PERFORMANCE

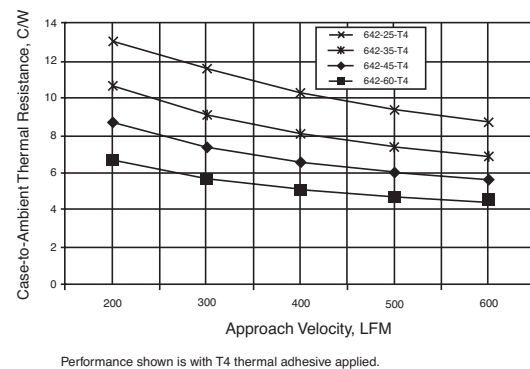

### OMNIDIRECTIONAL PIN FIN HEAT SINK FOR LIMITED HEIGHT BGAs 662 SERIES

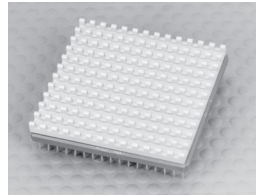

Standard P/N	Base Dimensions in. (mm)	Height in. (mm)	Typical Applications	Heat Sink Finish	Weight lbs. (grams)
662-15AG	1.713 (43.5) sq	0.150 (3.8)	45mm BGA	Gold Iridite	0.019 (8.50)
662-15AB	1.713 (43.5) sq	0.150 (3.8)	45mm BGA	Black Anodized	0.019 (8.50)

Notes: 1. Optional factory pre-applied pressure-sensitive adhesive. See Page 8.

#### MECHANICAL DIMENSIONS

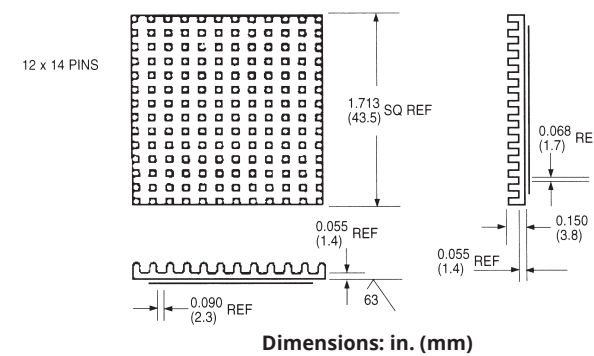

#### NATURAL AND FORCED CONVECTION CHARACTERISTICS

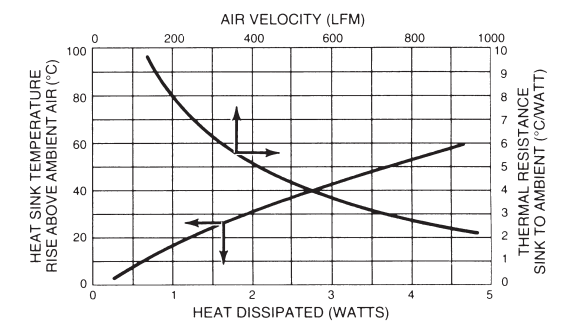

### 628 SERIES OMNIDIRECTIONAL PIN FIN HEAT SINK FOR BGAs

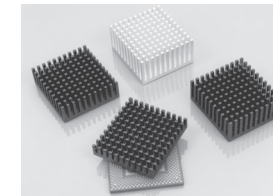

Standard P/N	Base Dimensions in. (mm)	Dimensions "A" in. (mm)	Typical Applications	Heat Sink Finish	Weight lbs. (grams)
628-20AB	1.750 (44.5) x 1.700 (43.2)	0.200 (5.1)	45mm BGA	Black Anodized	0.031 (14.17)
628-25AB	1.750 (44.5) x 1.700 (43.2)	0.250 (6.4)	45mm BGA	Black Anodized	0.038 (17.01)
628-35AB	1.750 (44.5) x 1.700 (43.2)	0.350 (8.9)	45mm BGA	Black Anodized	0.044 (19.84)
628-40AB	1.750 (44.5) x 1.700 (43.2)	0.400 (10.2)	45mm BGA	Black Anodized	0.050 (22.68)
628-65AB	1.750 (44.5) x 1.700 (43.2)	0.650 (16.5)	45mm BGA	Black Anodized	0.056 (25.51)

Notes: 1. Optional factory pre-applied pressure-sensitive adhesive. See Page 8.

#### MECHANICAL DIMENSIONS

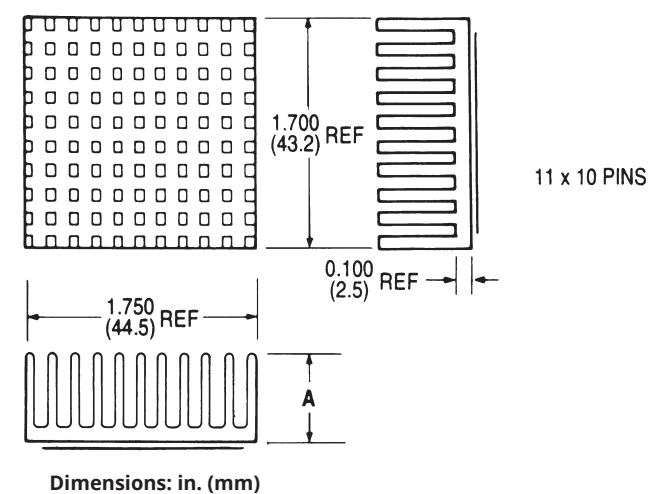

#### NATURAL CONVECTION CHARACTERISTICS

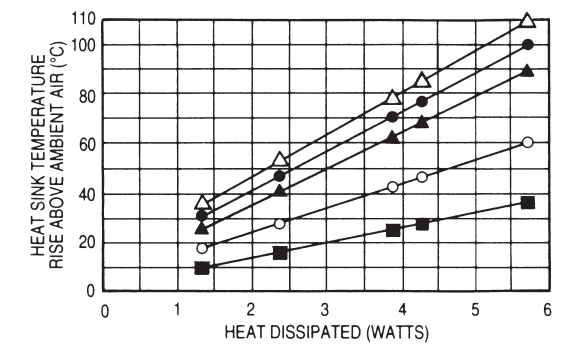

#### FORCED CONVECTION CHARACTERISTICS

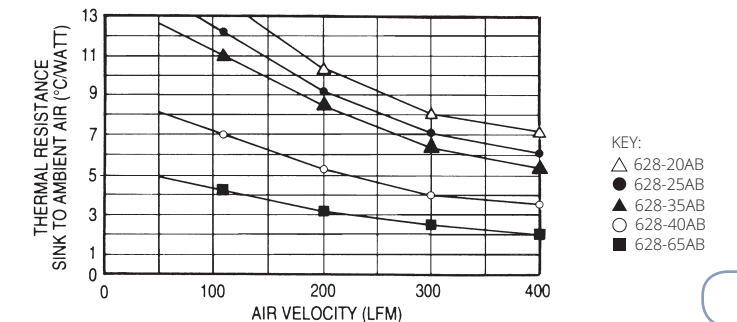

## HEAT SINKS FOR BGAs, SUPER BGAs, PBGAs, & FPBGAs

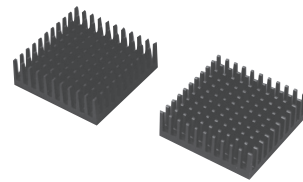

### 630 SERIES OMNIDIRECTIONAL PIN FIN HEAT SINK FOR BGAs

The **630 Series** is an omnidirectional pin fin heat sink for both natural and forced-convection applications.

Applications include network routers and switches, high-resolution printers, digital cameras, consumer video games, digital video disks (DVD) and global positioning systems (GPS).

Standard P/N	Base Dimensions in. Sq.	Fin Height "A" in. (mm)	Typical Applications	Weight lbs. (grams)
630-25AB	1.378 (35)	.250 (6.4)	35mm BGA	.009 (4.09)
630-35AB	1.378 (35)	.350 (8.9)	35mm BGA	.011 (4.99)
630-45AB	1.378 (35)	.450 (11.4)	35mm BGA	.015 (6.81)
630-60AB	1.378 (35)	.600 (15.2)	35mm BGA	.026 (11.80)

Material: Aluminum, Black Anodized

#### PRODUCT FEATURES

- Available in four standard heights, .25 inch, .35 inch, .45 inch, and .60 inch.
- Available with pressure sensitive adhesives for quick and easy mounting. See Page 8.

#### MECHANICAL DIMENSIONS

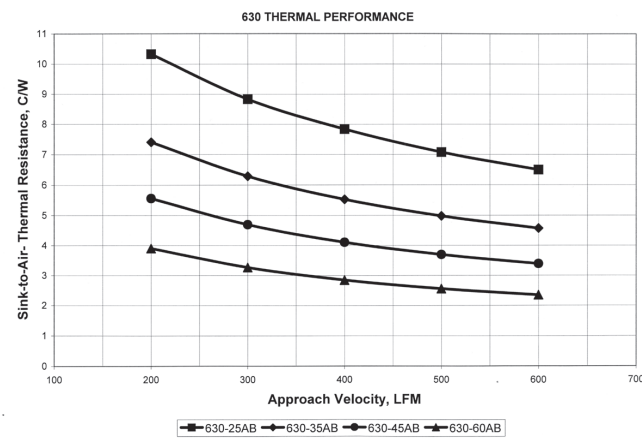
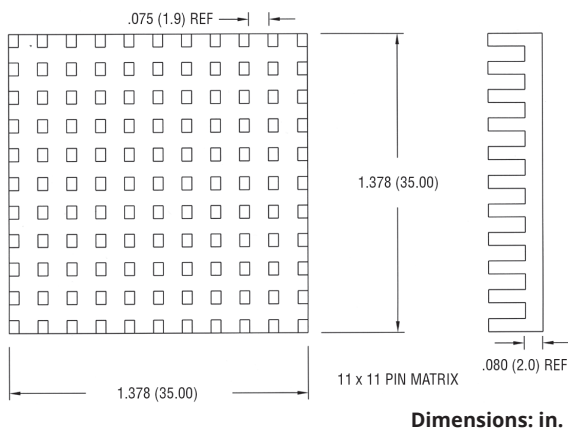

### PIN FIN HEAT SINK FOR BGAs **798 SERIES**

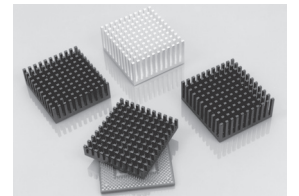

Standard P/N	Base Dimensions in. (mm)	Dimensions "A" in. (mm)	Typical Applications	Heat Sink Finish	Weight lbs. (grams)
798-40AB	2.100 (53.3) x 1.860 (47.2)	0.400 (10.2)	45mm BGA	Black Anodized	0.063 (28.35)
798-65AB	2.100 (53.3) x 1.860 (47.2)	0.650 (16.5)	45mm BGA	Black Anodized	0.106 (48.19)
798-80AB	2.100 (53.3) x 1.860 (47.2)	0.800 (20.3)	45mm BGA	Black Anodized	0.113 (51.03)
798-100AB	2.100 (53.3) x 1.860 (47.2)	1.000 (25.4)	45mm BGA	Black Anodized	0.131 (59.53)

#### MECHANICAL DIMENSIONS

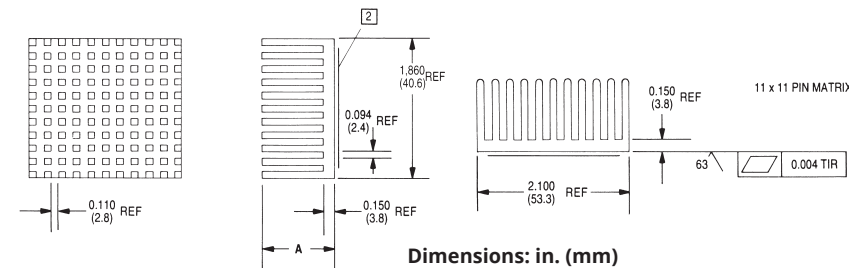

#### FORCED CONVECTION THERMAL PERFORMANCE DATA (FLOW PARALLEL TO EXTRUSION DIRECTION)

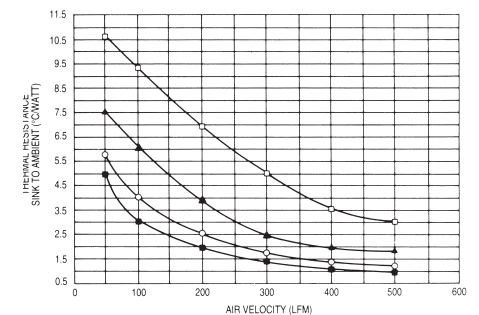

#### NOTES:

- Heat sink mounting surface flatness: 0.004" TIR
- Optional factory pre-applied pressure-sensitive adhesive. See Page 8.

KEY: 798-40AB (square), 798-65AB (circle), 798-80AB (triangle), 798-100AB (diamond)

### OMNIDIRECTIONAL PIN FIN HEAT SINK FOR BGAs **698 SERIES**

Standard P/N	Base Dimensions in. (mm)	Dimensions "A" in. (mm)	Typical Applications	Heat Sink Finish	Weight lbs. (grams)
698-40AB	2.100 (53.3) sq.	0.400 (10.2) sq.	45mm BGA	Black Anodized	0.075 (34.02)
698-65AB	2.100 (53.3) sq.	0.650 (16.5) sq.	45mm BGA	Black Anodized	0.119 (53.86)
698-80AB	2.100 (53.3) sq.	0.800 (20.3) sq.	45mm BGA	Black Anodized	0.125 (56.70)
698-100AB	2.100 (53.3) sq.	1.000 (25.4) sq.	45mm BGA	Black Anodized	0.144 (65.20)

Notes: 1. Optional factory preapplied pressure-sensitive adhesive. See Page 8.

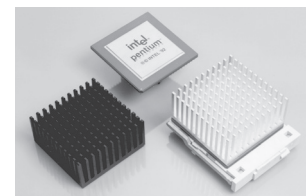

#### MECHANICAL DIMENSIONS

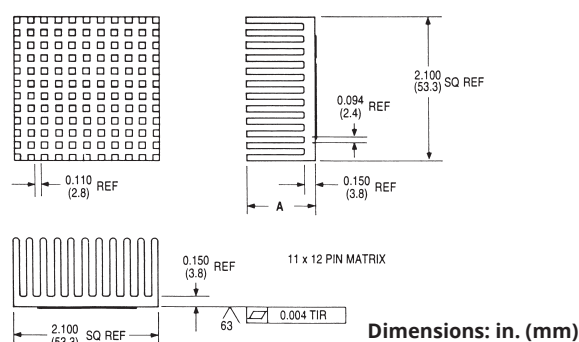

#### FORCED CONVECTION THERMAL PERFORMANCE DATA (FLOW PARALLEL TO EXTRUSION DIRECTION)

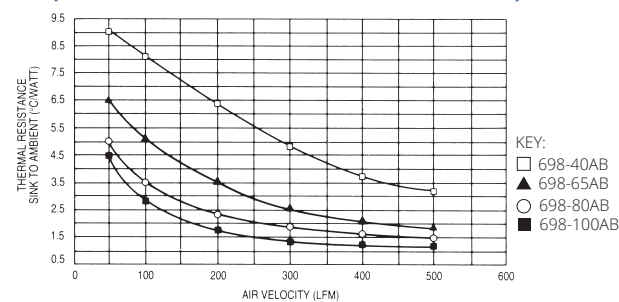

### **643 SERIES** OMNIDIRECTIONAL PIN FIN HEAT SINK FOR BGAs

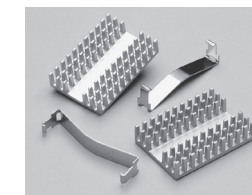

The **Series 643-35AP** is an omnidirectional pin fin heat sink for both natural and forced-convection applications designed to fit a 40 mm BGA.

Applications include network routers and switches, high-resolution printers, digital cameras, consumer video games, digital video disks (DVD) and global positioning systems (GPS).

#### PRODUCT FEATURES

- Available with pressure sensitive adhesives to ensure good thermal performance. See page 8.
- Can be ordered with the **829SC clip**. Order clip separately. (Clip cannot be purchased without heat sink)

Standard P/N	Base Dimensions in. (mm)	Fin Height in. (mm)	Typical Applications	Weight lbs. (grams)
643-35AP	1.60 (40.64) x 1.10 (27.94)	0.350 (8.89)	40 mm BGA	.070 (31.78)

Material: Aluminum, Plain Finish

#### MECHANICAL DIMENSIONS

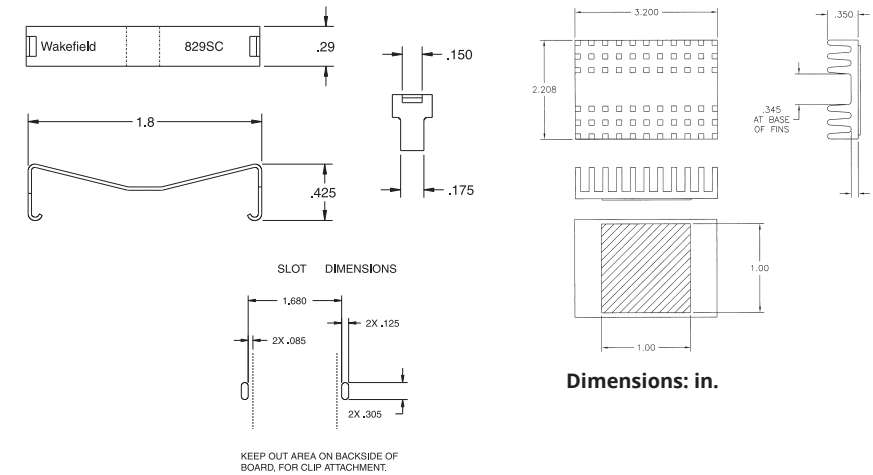

#### 643 THERMAL PERFORMANCE

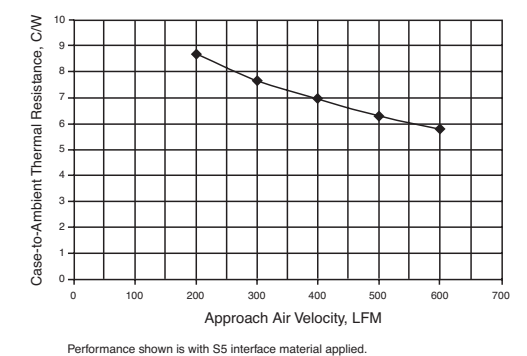

## DELTEM™ COMPOSITE HEAT SINKS FOR BGAs

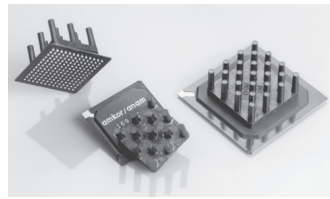

### DELTEM™ D10650-40 PIN FIN HEAT SINK

Standard P/N	Base Dimensions in. (mm)	Height in. (mm)	Weight lbs. (grams)
D10650-40	0.650 (16.5) sq	0.400 (10.2)	0.004 (1.91)

**Notes:** Available with pressure sensitive adhesives for quick and easy mounting. See Page 8.

### PIN FIN HEAT SINK DELTEM™ D10850-40

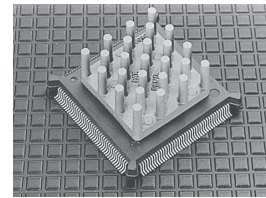

Standard P/N	Base Dimensions in. (mm)	Height in. (mm)	Typical Applications	Weight lbs. (grams)
D10850-40	0.850 (21.6) sq	0.400 (10.2)	21mm BGA	0.006 (3.9)

**Notes:** Available with pressure sensitive adhesives for quick and easy mounting. See Page 8.

#### MECHANICAL DIMENSIONS

##### DELTEM™ D10650-40 PIN FIN HEAT SINK

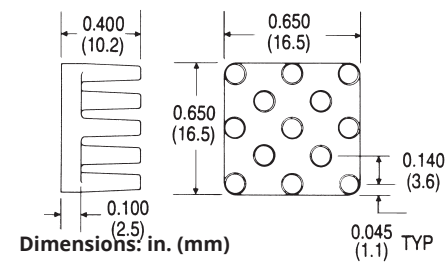

#### NATURAL AND FORCED CONVECTION CHARACTERISTICS

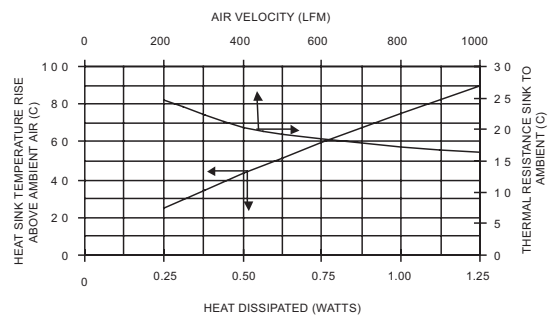

##### DELTEM™ D10850-40 PIN FIN HEAT SINK

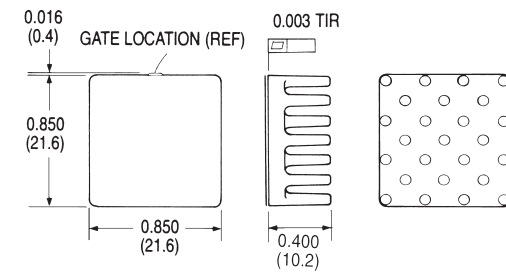

#### NATURAL AND FORCED CONVECTION CHARACTERISTICS

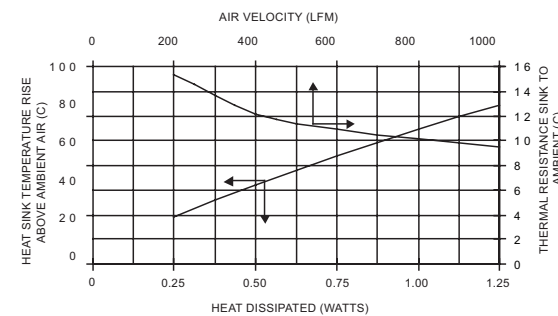

## HEAT SINKS FOR BGAs, SUPER BGAs, PBGAs, & FPBGAs

### PIN FIN HEAT SINK FOR BGAs HEAT SINK/CLIP ASSEMBLY FOR BGAs AND POWERPC™ PACKAGES

### 609 SERIES

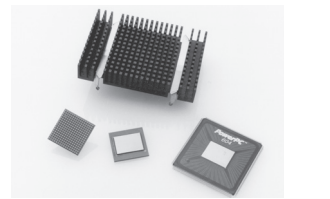

Standard P/N	Base Dimensions in. (mm)	Dimensions "A" in. (mm)	Typical Applications	Heat Sink Finish	Weight lbs. (grams)
609-50AB	2.895 (73.5) x 2.000 (50.8)	0.500 (12.7)	40&45mm BGA	Black Anodized	0.094 (42.5)
609-100AB	2.808 (71.32) x 1.700 (43.2)	1.00 (25.4)	40&45mm BGA	Black Anodized	0.130 (59.0)

**Note:** Optional factory pre-applied thermal interface material.  
S3 (Bergquist Q-Pad 3, 0.14 °C in<sup>2</sup>/w)  
S4 (Bergquist Softface, 0.07 °C in<sup>2</sup>/w)

#### MECHANICAL DIMENSIONS

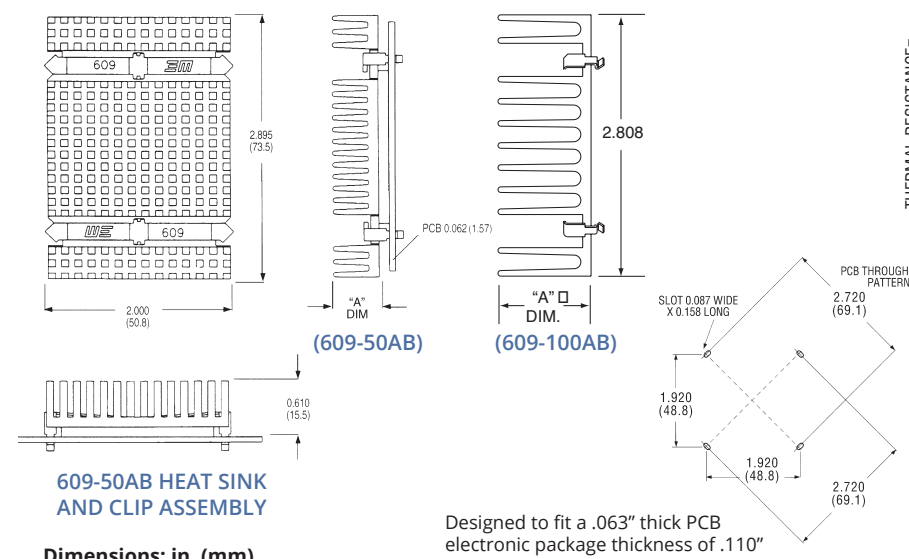

#### FORCED CONVECTION THERMAL PERFORMANCE DATA (FLOW PARALLEL TO EXTRUSION DIRECTION)

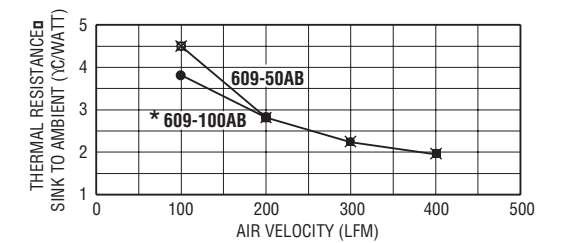

\*Performance is for shrouded conditions. 609-100 will perform better than 609-50 in cases with bypass.

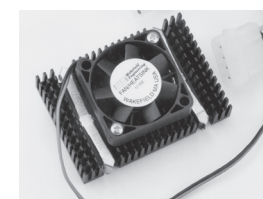

### 619 SERIES FAN HEAT SINK FOR BGA AND POWERPC™ PACKAGES

Standard P/N	Base Dimensions in. (mm)	Height in. (mm)	Typical Applications	Heat Sink Finish	Thermal Performance	Weight lbs. (grams)
61995AB124D1	2.871 (72.92) x 1.98 (50.29)	0.953 (24.21)	40&45mm BGA	Black Anodized	1.2° C/W	.150 (68.10)
61995AB054D1	2.871 (72.92) x 1.98 (50.29)	0.953 (24.21)	40&45mm BGA	Black Anodized	1.2° C/W	.150 (68.10)

**Note:** Optional factory pre-applied thermal interface material. See 609 series.

#### MECHANICAL DIMENSIONS

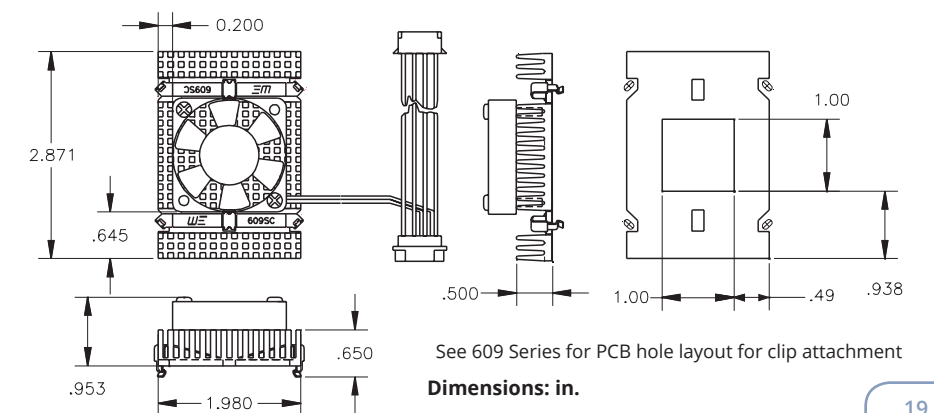

See 609 Series for PCB hole layout for clip attachment

Dimensions: in.

#### FEATURES AND BENEFITS

- Captivated clips for ease of assembly.
- Low acoustic noise.
- Impingement air flow.
- Accommodates BGA packages up to 45 mm in size.



## HEAT SINKS FOR BGAs, SUPER BGAs, PBGAs, & FPBGAs

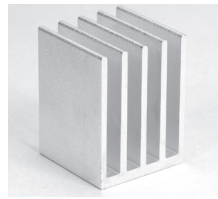

### 602 SERIES

UNIDIRECTIONAL FIN HEAT SINK FOR BGAs

Standard P/N	Base Dimensions in. (mm)	Height in. (mm)	Heat Sink Finish	Weight lbs. (grams)
602-100AP	.750 (19.1) sq	1.000 (25.4)	Plain	.021 (9.59)

**Material:** Aluminum, Plain Finish

#### MECHANICAL DIMENSIONS

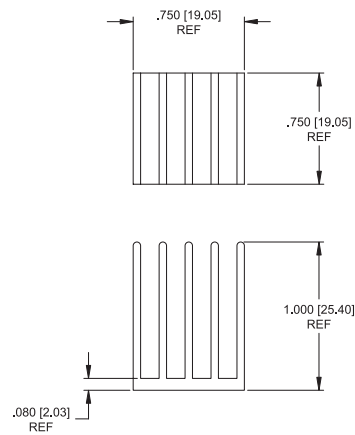

#### 602 THERMAL PERFORMANCE

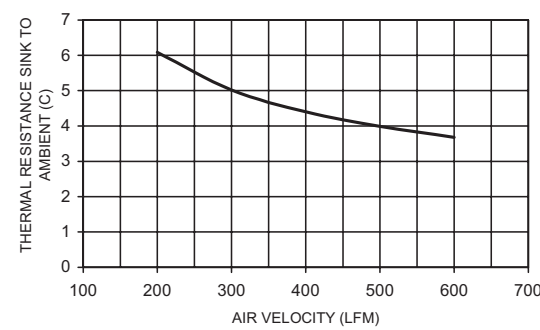

UNIDIRECTIONAL FIN HEAT SINK FOR BGAs

### 605 SERIES

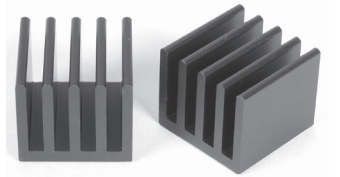

Standard P/N	Base Dimensions in. (mm)	Height in. (mm)	Heat Sink Finish	Weight lbs. (grams)
605-75AB	.880 (22.4) sq	.750 (19.1)	Black Anodized	.030 (13.5)

**Material:** Aluminum, Black Anodized

#### MECHANICAL DIMENSIONS

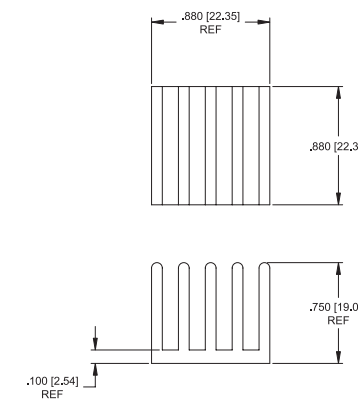

#### 605 THERMAL PERFORMANCE

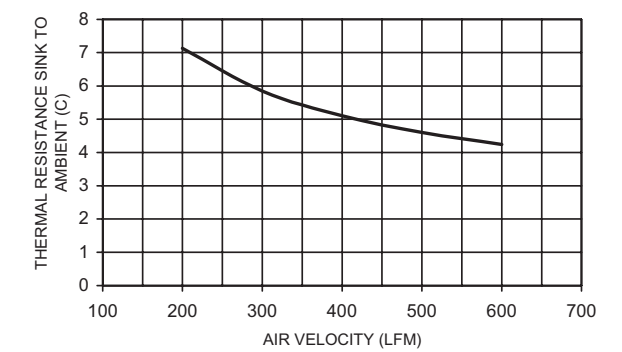

OMNIDIRECTIONAL PIN FIN HEAT SINK FOR BGAs

### 604 SERIES

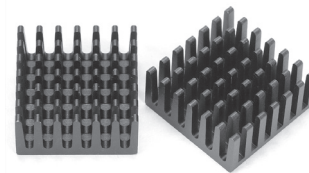

Standard P/N	Base Dimensions in. (mm)	Height in. (mm)	Heat Sink Finish	Weight lbs. (grams)
604-40AB	.850 (21.6) sq	.400 (10.2)	Black Anodized	.012 (5.60)
604-60AB	.850 (21.6) sq	.600 (15.2)	Black Anodized	.016 (7.47)

**Material:** Aluminum, Black Anodized

#### MECHANICAL DIMENSIONS

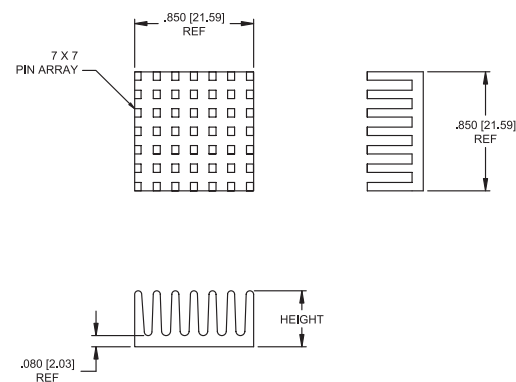

#### 604 THERMAL PERFORMANCE

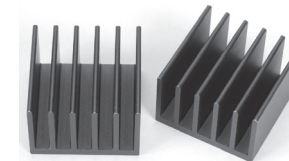
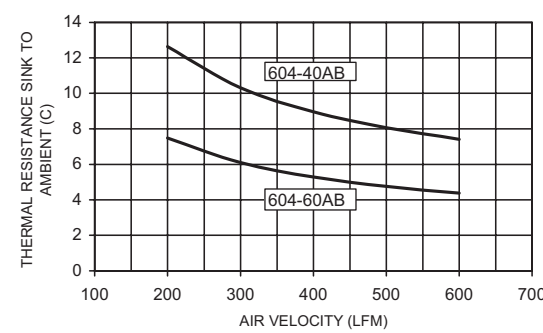

### 606 SERIES

UNIDIRECTIONAL FIN HEAT SINK FOR BGAs

Standard P/N	Base Dimensions in. (mm)	Height in. (mm)	Heat Sink Finish	Weight lbs. (grams)
606-77AB	1.185 (30.1) sq	.767 (19.5)	Black Anodized	.041 (18.7)

**Material:** Aluminum, Black Anodized

#### MECHANICAL DIMENSIONS

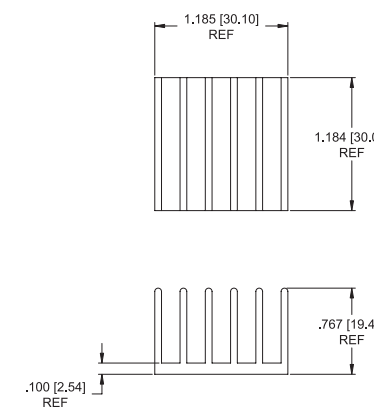

#### 606 THERMAL PERFORMANCE

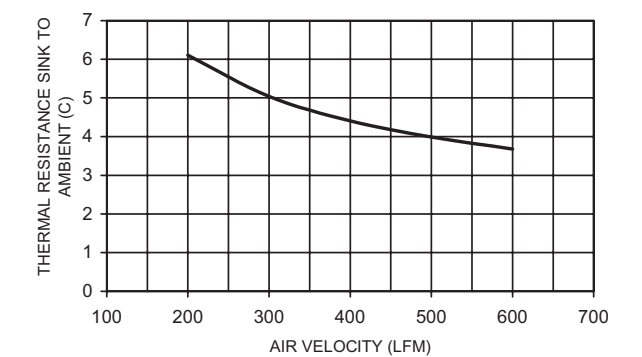



## HEAT SINKS FOR BGAs, SUPER BGAs, PBGAs, & FPBGAs

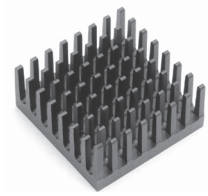

### 607 SERIES

UNIDIRECTIONAL FIN HEAT SINK FOR BGAs

Standard P/N	Base Dimensions in. (mm)	Height in. (mm)	Heat Sink Finish	Weight lbs. (grams)
607-65AB	1.200 (30.5) x 1.105 (28.1)	.650 (16.5)	Black Anodized	.041 (18.7)
<b>Material:</b> Aluminum, Black Anodized				

#### MECHANICAL DIMENSIONS

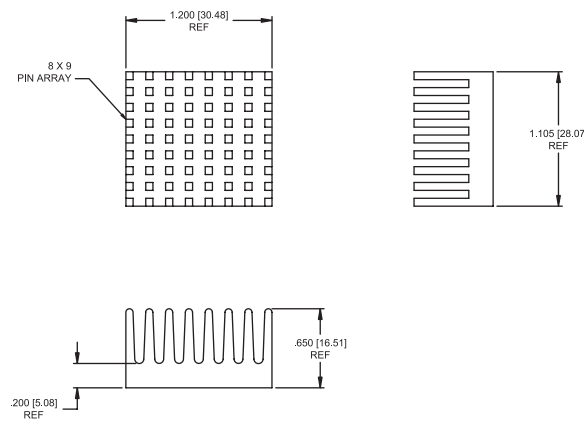

#### 607 THERMAL PERFORMANCE

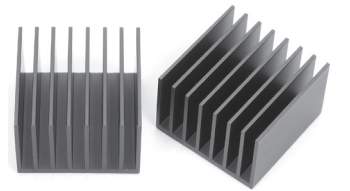
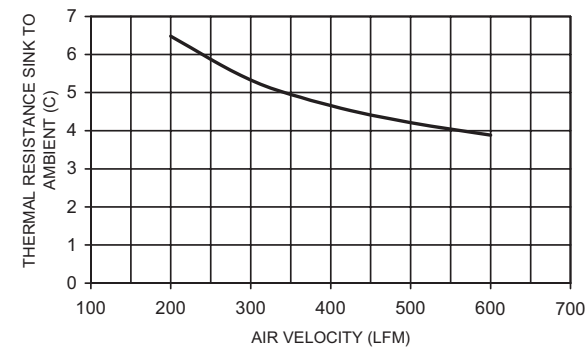

UNIDIRECTIONAL FIN HEAT SINK FOR BGAs

### 611 SERIES

Standard P/N	Base Dimensions in. (mm)	Height in. (mm)	Heat Sink Finish	Weight lbs. (grams)
611-80AB	1.200 (30.5) sq	.800 (20.3)	Black Anodized	.036 (16.3)
<b>Material:</b> Aluminum, Black Anodized				

#### MECHANICAL DIMENSIONS

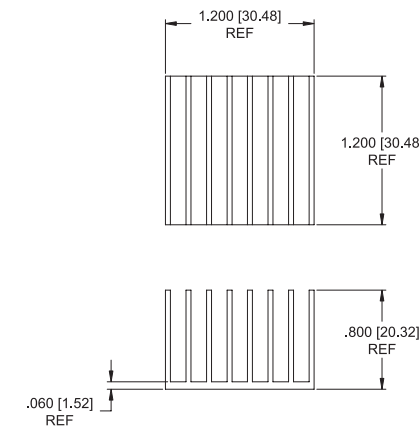

#### 611 THERMAL PERFORMANCE

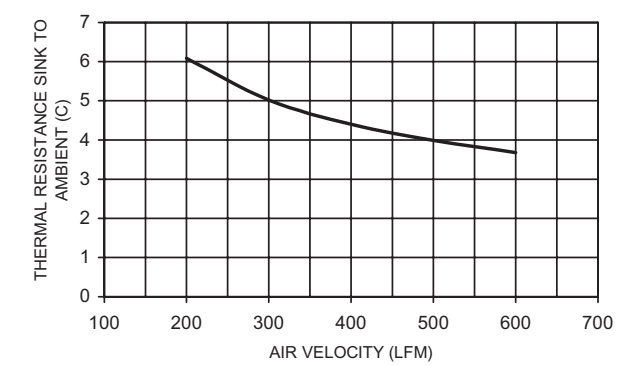

OMNIDIRECTIONAL PIN FIN HEAT SINK FOR BGAs

### 610 SERIES

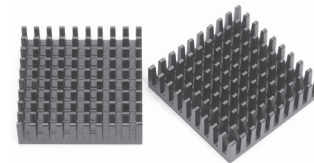

Standard P/N	Base Dimensions in. (mm)	Height in. (mm)	Heat Sink Finish	Weight lbs. (grams)
610-35AB	1.240 (31.5) sq	.350 (8.9)	Black Anodized	.022 (10.0)
610-40AB	1.240 (31.5) sq	.400 (10.2)	Black Anodized	.024 (10.8)
<b>Material:</b> Aluminum, Black Anodized				

#### MECHANICAL DIMENSIONS

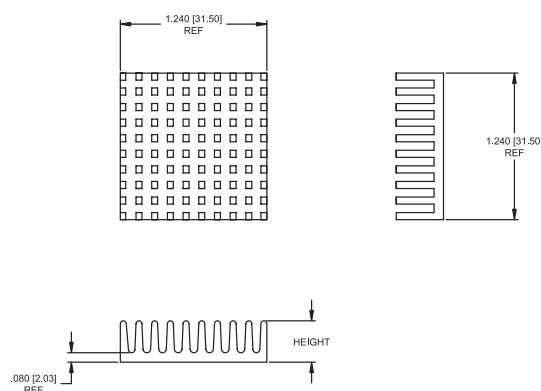

#### 610 THERMAL PERFORMANCE

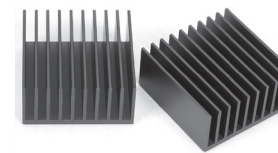
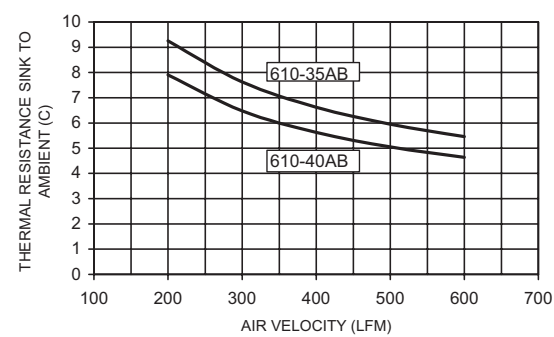

### 612 SERIES

UNIDIRECTIONAL FIN HEAT SINK FOR BGAs

Standard P/N	Base Dimensions in. (mm)	Height in. (mm)	Heat Sink Finish	Weight lbs. (grams)
612-65AB	1.390 (35.3) sq	.650 (16.5)	Black Anodized	.054 (24.5)
<b>Material:</b> Aluminum, Black Anodized				

#### MECHANICAL DIMENSIONS

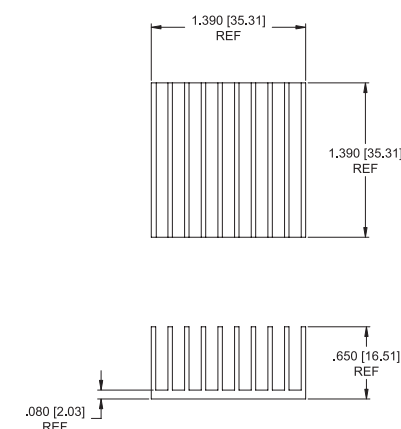

#### 612 THERMAL PERFORMANCE

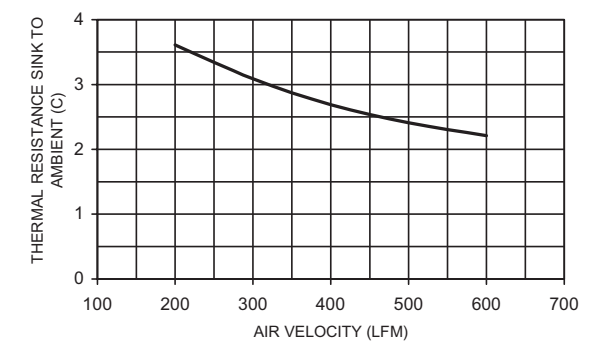

## HEAT SINKS FOR BGAs, SUPER BGAs, PBGAs, & FPBGAs

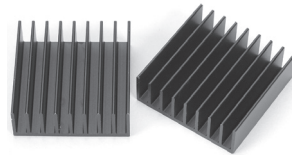

### 613 SERIES UNIDIRECTIONAL FIN HEAT SINK FOR BGAs

Standard P/N	Base Dimensions in. (mm)	Height in. (mm)	Heat Sink Finish	Weight lbs. (grams)
613-50AB	1.450 (36.8) sq	.500 (12.7)	Black Anodized	.046 (20.8)

**Material:** Aluminum, Black Anodized

#### MECHANICAL DIMENSIONS

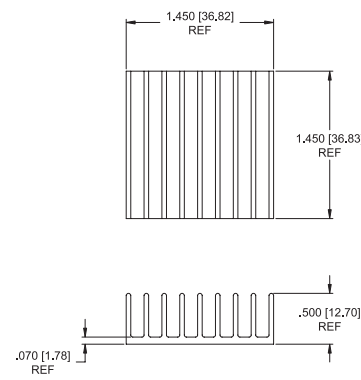

#### 613 THERMAL PERFORMANCE

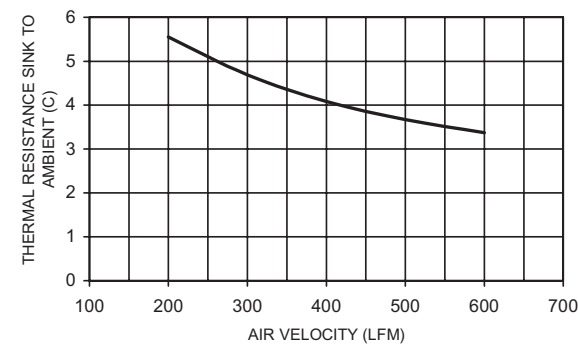

### UNIDIRECTIONAL FIN HEAT SINK FOR BGAs

### 614 SERIES

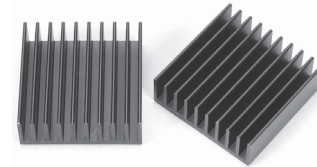

Standard P/N	Base Dimensions in. (mm)	Height in. (mm)	Heat Sink Finish	Weight lbs. (grams)
614-30AB	1.500 (38.1) sq	.300 (7.6)	Black Anodized	.030 (13.8)
614-50AB	1.500 (38.1) sq	.500 (12.7)	Black Anodized	.048 (21.8)
614-100AP	1.500 (38.1) sq	1.000 (25.4)	Plain	.046 (20.9)

**Material:** Aluminum, Black Anodized or Plain

#### MECHANICAL DIMENSIONS

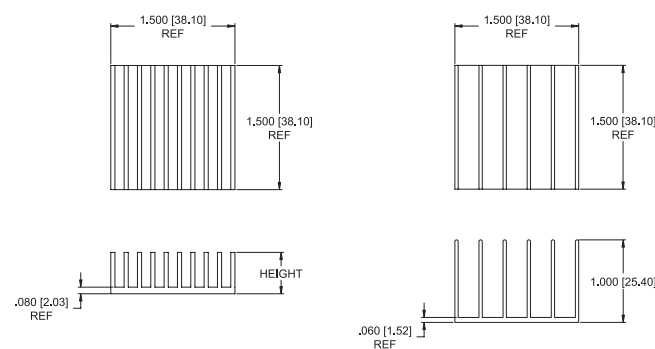

#### 614 THERMAL PERFORMANCE

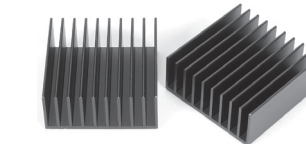
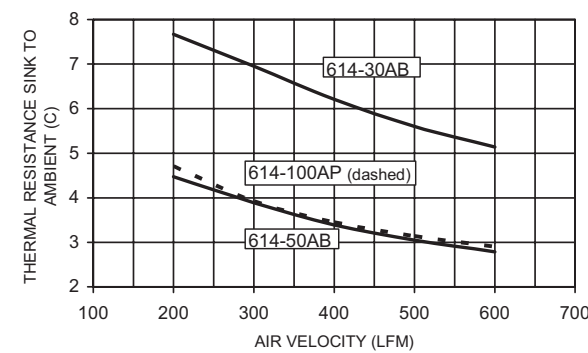

### 616 SERIES

### UNIDIRECTIONAL FIN HEAT SINK FOR BGAs

Standard P/N	Base Dimensions in. (mm)	Height in. (mm)	Heat Sink Finish	Weight lbs. (grams)
616-80AB	1.85 (46.9) sq	.800 (20.3)	Black Anodized	.054 (24.5)

**Material:** Aluminum, Black Anodized

#### MECHANICAL DIMENSIONS

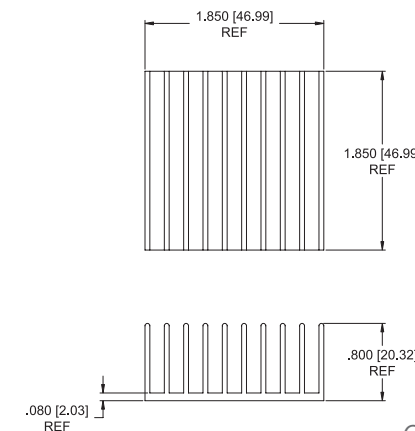

#### 616 THERMAL PERFORMANCE

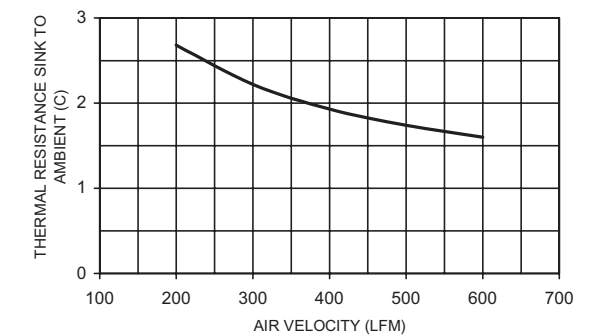

Contact us: (603) 635-2800

## HEAT SINKS FOR BGAs, SUPER BGAs, PBGAs, & FPBGAs

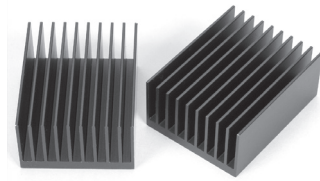

### 617 SERIES

UNIDIRECTIONAL FIN HEAT SINK FOR BGAs

Standard P/N	Base Dimensions in. (mm)	Height in. (mm)	Heat Sink Finish	Weight lbs. (grams)
617-80AB	1.450 (36.8) x 1.850 (47.0)	.800 (20.3)	Black Anodized	.082 (37.2)
<b>Material:</b> Aluminum, Black Anodized				

#### MECHANICAL DIMENSIONS

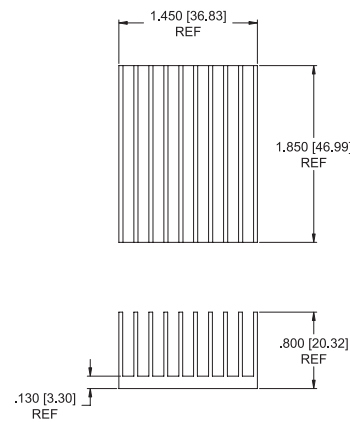

#### 617 THERMAL PERFORMANCE

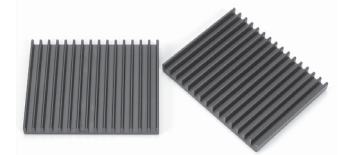
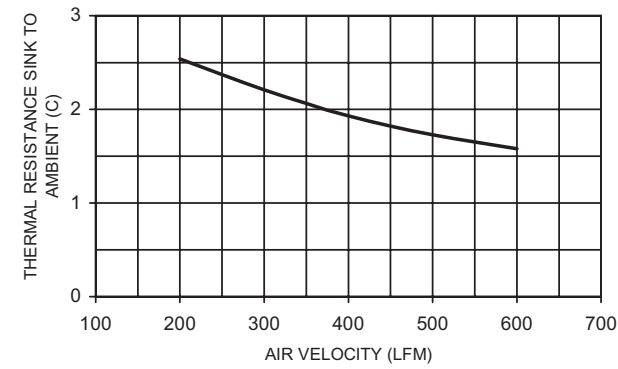

UNIDIRECTIONAL FIN HEAT SINK FOR BGAs

### 620 SERIES

Standard P/N	Base Dimensions in. (mm)	Height in. (mm)	Heat Sink Finish	Weight lbs. (grams)
620-24AB	2.500 (63.5) x 2.000 (50.8)	.235 (6.0)	Black Anodized	.063 (28.6)
<b>Material:</b> Aluminum, Black Anodized				

#### MECHANICAL DIMENSIONS

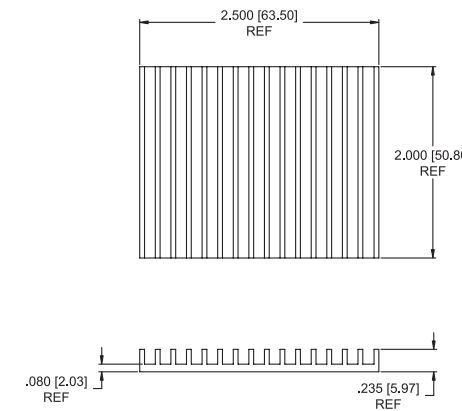

#### 620 THERMAL PERFORMANCE

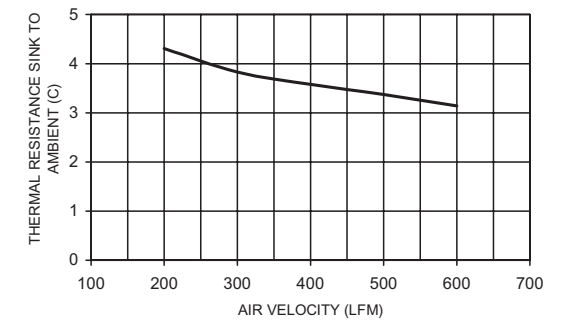

UNIDIRECTIONAL FIN HEAT SINK FOR BGAs

### 618 SERIES

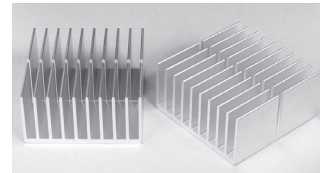

Standard P/N	Base Dimensions in. (mm)	Height in. (mm)	Heat Sink Finish	Weight lbs. (grams)
618-20AB	2.00 (50.8) sq	.200 (5.1)	Black Anodized	.046 (21.0)
618-100AP	2.00 (80.8) sq	1.000 (25.4)	Plain	.122 (55.5)
<b>Material:</b> Aluminum, Black Anodized or Plain				

#### MECHANICAL DIMENSIONS

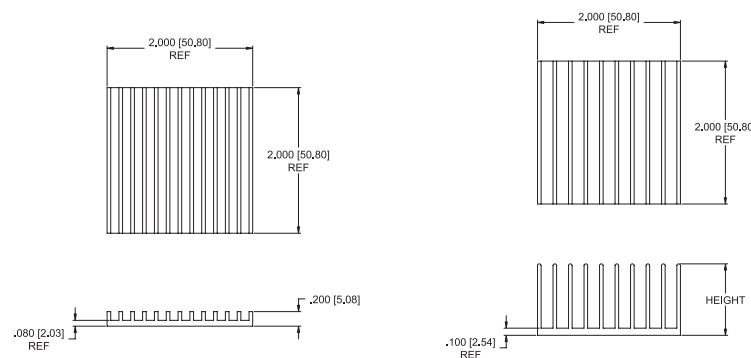

#### 618 THERMAL PERFORMANCE

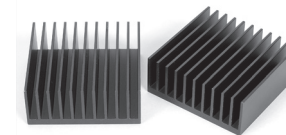
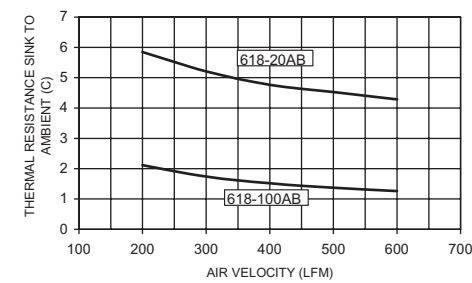

### 622 SERIES

UNIDIRECTIONAL FIN HEAT SINK FOR BGAs

Standard P/N	Base Dimensions in. (mm)	Height in. (mm)	Heat Sink Finish	Weight lbs. (grams)
622-80AB	2.050 (52.1) x 2.000 (50.8)	.800 (20.3)	Black Anodized	.123 (56.0)
<b>Material:</b> Aluminum, Black Anodized				

#### MECHANICAL DIMENSIONS

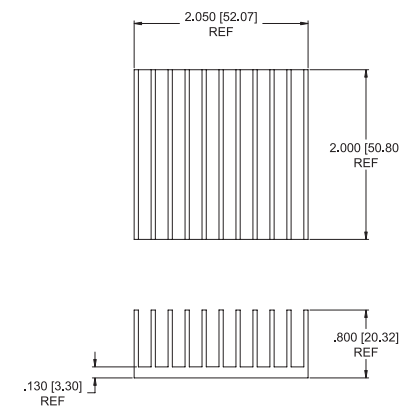

#### 622 THERMAL PERFORMANCE

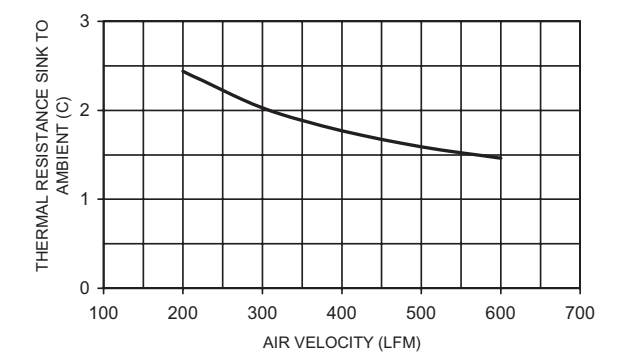



## HEAT SINKS FOR MICROPROCESSORS & ASICs

### 569, 579, 589, 599 SERIES

HEAT SINKS & CLIP FOR INTEL'S PENTIUM, PENTIUM MMX, AMD'S K6 & K62, CYRIX'S 6X86 & MEDIA GX, CENTAUR/IDT'S WINCHIP C6

#### PRODUCT FEATURES

- Compact design heat sinks can comfortably fit a variety of Robust Socket 7-based PC boxes.
- Robust clip attachments.
- Clips are not captive to sink.
- To order heat sink with optional interface material pre-applied at the factory, add S4 or S5 suffix to the part number. (See Product Designation)

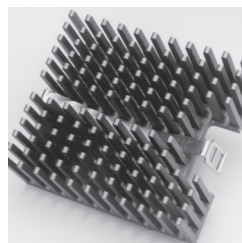

569-100AK SERIES

Standard P/N	Base Dimensions in. (mm)	Fin Height in. (mm)	Thermal Resistance at 200 LFM (°C/W)	Interface Material Options
569-100AK	2.34 (59.44) x 2.68 (67.95)	1.00 (25.4)	1.7	Pages 74-76
579-150AK	2.15 (54.71) x 1.95 (49.53)	1.50 (38.10)	1.6	Pages 74-76
589-150AK	2.15 (54.71) x 3.10 (78.74)	1.50 (38.10)	1.5	Pages 74-76
599X-100AB	1.96 (49.78) x 2.67 (67.95)	1.00 (25.4)	1.9	Pages 74-76

Material: Aluminum, Black Anodized

#### MECHANICAL DIMENSIONS

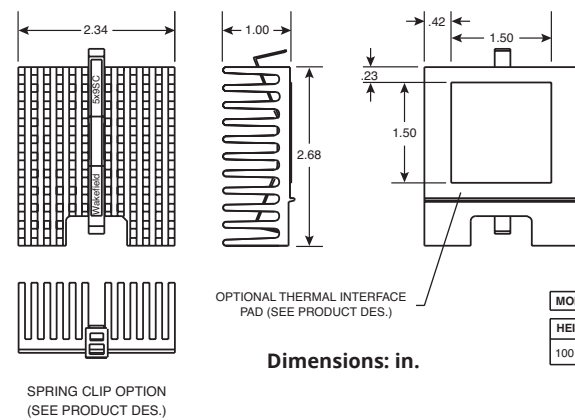

#### PRODUCT DESIGNATION

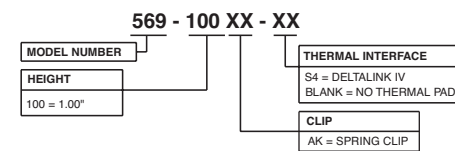

18 x 18 PGA

SPIDERCLIP™ HEAT SINK ASSEMBLY  
FOR MOTOROLA MC68040™, MC68060

### 649 SERIES

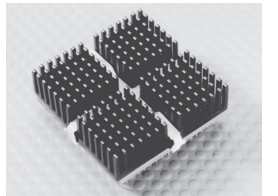

Standard P/N	Base Dimensions in. (mm)	Height in. (mm)	Base Thickness in. (mm)	Clip Color	Heat Sink Finish	Weight lbs. (grams)
649-33AB	1.70 (43.2) sq	0.315 (8.0)	0.090 (2.3)	Gray	Black Anodized	0.044 (19.84)
649-51AB	1.86 (47.2) sq	0.510 (13.0)	0.090 (2.3)	Gray	Black Anodized	0.056 (25.51)

#### MECHANICAL DIMENSIONS

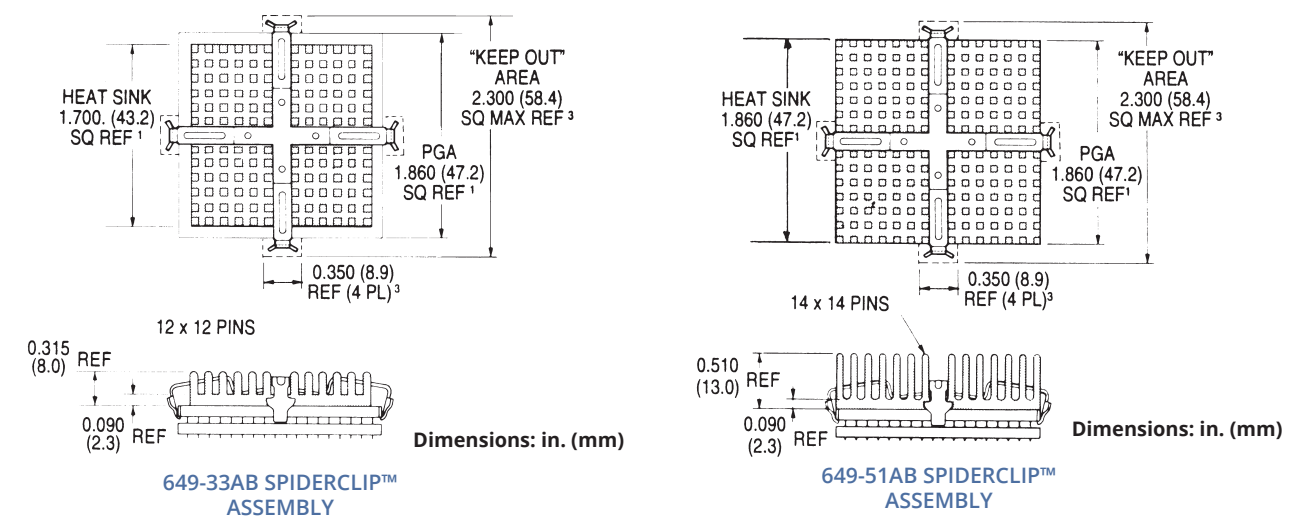

LOW-COST HEAT SINKS  
FOR DIPs AND SRAMs

### 650 & 651 SERIES

14-16 Pin DIPs

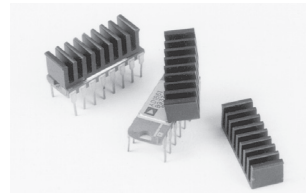

These extruded heat sinks serve as low-cost heat dissipation solutions for DIPs with pin counts from 14 to 16. Use an epoxy such as Wakefield-Vette Engineering DeltaBond™ 152 or 155, or use Wakefield-Vette 2-part DeltaBond™ 156 modified acrylic adhesive. The 650 and 651 are also available in natural aluminum finish. They can be ordered as 650P or 651P.

Standard P/N	Length in. (mm)	Width in. (mm)	Height in. (mm)	Typical Applications	Weight lbs. (grams)
650B	0.250 (6.4)	0.740 (18.9)	0.240 (6.1)	14-Pin, 16-Pin DIP	0.003 (1.36)
651B	0.750 (19.1)	0.415 (10.5)	0.240 (6.1)	14-Pin, 16-Pin DIP	0.005 (2.27)

#### MECHANICAL DIMENSIONS

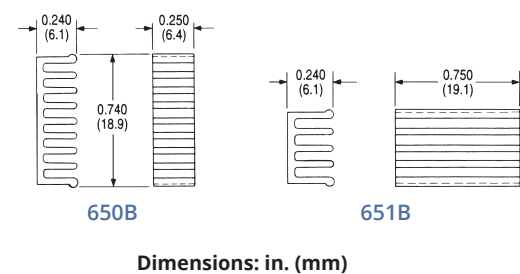

#### NATURAL AND FORCED CONVECTION CHARACTERISTICS

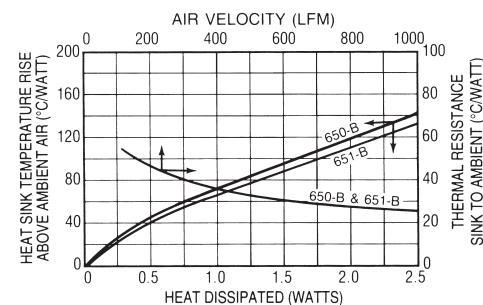

#### NOTES:

1. Finish: black anodize
2. TIR: Total Indicator Reading. This is a measure of flatness across the greatest dimension of a surface.

#### NATURAL AND FORCED CONVECTION CHARACTERISTICS

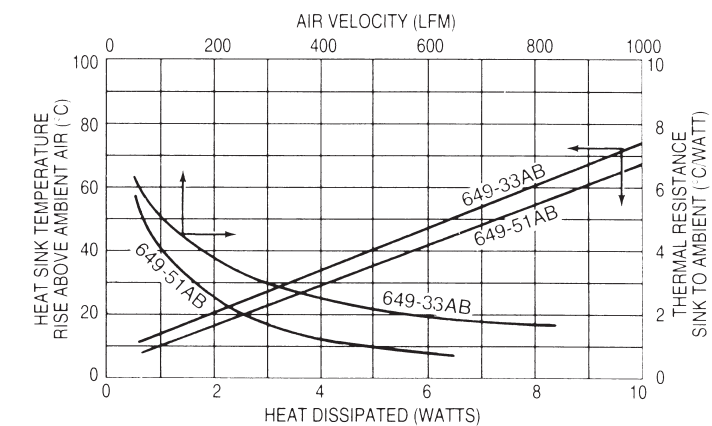

## HEAT SINKS FOR MICROPROCESSORS & ASICs

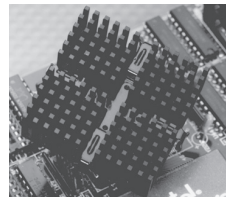

### 669 SERIES

SPIDERCLIP™ HEAT SINK ASSEMBLY FOR INTEL DX4™, AMD AM486DX2, AND AM486DX4

17 x 17 SPGA

### 661 SERIES

HEAT SINK WITHOUT CLIP

669 Series SpiderClip™ Heat Sink Assemblies may be applied to the following:

- Intel 80486DX and 80486DX2™ (168 PGA)
- Intel DX4™ (168 PGA)
- Intel 80486SX (168 PGA) and I860XR (208 PGA)
- AMD Am 486 Microprocessors AM486DX2, AM486DX4
- Intel 82495 Cache Controller
- AMD Am 29000 Microcontrollers
- Intel I960CA, I960CF Embedded Controllers

Standard P/N	Base Dimensions in. (mm)	Dimensions "A" Height in. (mm)	Base Thickness in. (mm)	Clip Color	Standard Finish	Weight lbs. (grams)
669-32AG	1.70 (43.2) sq	0.315 (8.0)	0.090 (2.3)	Black	Gold Iridite	0.044 (19.84)
669-33AB	1.70 (43.2) sq	0.315 (8.0)	0.090 (2.3)	Black	Black Anodized	0.044 (19.84)
669-40AB	1.70 (43.2) sq	0.400 (10.2)	0.090 (2.3)	Black	Black Anodized	0.044 (19.84)
669-52AB	1.70 (43.2) sq	0.520 (13.2)	0.090 (2.3)	Black	Black Anodized	0.050 (22.68)
661-32AG	1.70 (43.2) sq	0.315 (8.0)	0.090 (2.3)	N/A	Gold Iridite	0.044 (19.84)
661-33AB	1.70 (43.2) sq	0.315 (8.0)	0.090 (2.3)	N/A	Black Anodized	0.044 (19.84)
661-40AB	1.70 (43.2) sq	0.400 (10.2)	0.090 (2.3)	N/A	Black Anodized	0.044 (19.84)
661-52AB	1.70 (43.2) sq	0.520 (13.2)	0.090 (2.3)	N/A	Black Anodized	0.050 (22.68)

### MECHANICAL DIMENSIONS

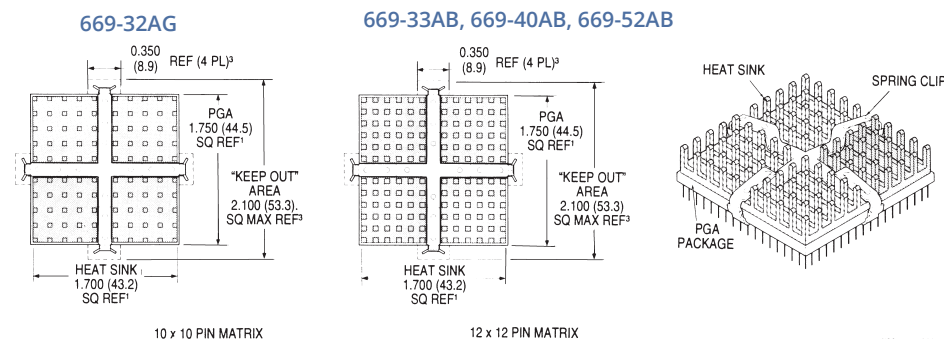

Dimensions: in. (mm)  
Dielectric Breakdown (Nylon Clip Coating)  
Dielectric Strength: 100 VDC/mil  
Breakdown Voltage: 200 VDC (minimum)

### NATURAL AND FORCED CONVECTION CHARACTERISTICS

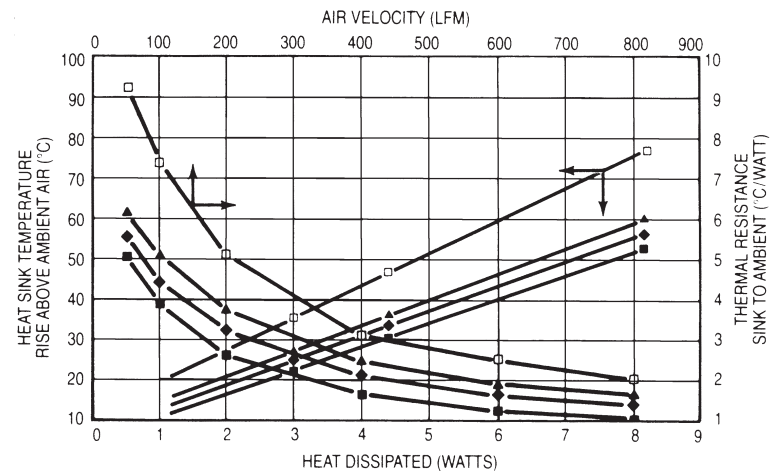

## PIN FIN HEAT SINK



### 900 SERIES

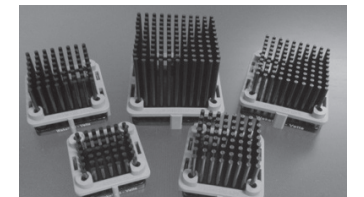

Wakefield-Vette's 900 Series Heat Sinks for Chipset can match up to devices from Intel, Xilinx, TI, Motorola, ATI, AMD, Nvidia, Vishay, Powerex, Infineon, Microsemi, and many more.

These heat sinks are designed for air flow applications in the Telecom, Data Center, Networking, Cloud Computing, and many more Industries.

Series	Height	Chip Size	Natural Convection	Forced Convection			Series	Height	Chip Size	Natural Convection	Forced Convection		
				200 LFM	400 LFM	600 LFM					200 LFM	400 LFM	600 LFM
901	12	19mm	12.74 C/W	6.6 C/W	4.79 C/W	4.16 C/W	906	12	31mm	10.71 C/W	3.49 C/W	2.28 C/W	1.69 C/W
	15	19mm	12.05 C/W	6.3 C/W	4.51 C/W	3.86 C/W		15	31mm	10.14 C/W	3.18 C/W	2.03 C/W	1.5 C/W
	18	19mm	11.35 C/W	5.97 C/W	4.16 C/W	3.47 C/W		18	31mm	9.57 C/W	2.93 C/W	1.86 C/W	1.33 C/W
	21	19mm	10.66 C/W	5.66 C/W	3.89 C/W	3.21 C/W		21	31mm	9.01 C/W	2.72 C/W	1.69 C/W	1.2 C/W
	23	19mm	10.55 C/W	5.36 C/W	3.64 C/W	2.99 C/W		23	31mm	8.88 C/W	2.5 C/W	1.54 C/W	1.07 C/W
	28	19mm	10.27 C/W	4.91 C/W	3.36 C/W	2.71 C/W		28	31mm	8.56 C/W	2.26 C/W	1.38 C/W	.96 C/W
902	12	21mm	12.4 C/W	6.61 C/W	4.37 C/W	3.7 C/W	907	12	33mm	10.37 C/W	3.32 C/W	2.18 C/W	1.62 C/W
	15	21mm	11.73 C/W	5.84 C/W	4.09 C/W	3.42 C/W		15	33mm	9.82 C/W	3.14 C/W	1.99 C/W	1.45 C/W
	18	21mm	11.06 C/W	5.51 C/W	3.76 C/W	3.07 C/W		18	33mm	9.28 C/W	2.89 C/W	1.78 C/W	1.3 C/W
	21	21mm	10.38 C/W	5.20 C/W	3.49 C/W	2.84 C/W		21	33mm	8.73 C/W	2.67 C/W	1.60 C/W	1.13 C/W
	23	21mm	10.27 C/W	4.9 C/W	3.26 C/W	2.62 C/W		23	33mm	8.60 C/W	2.45 C/W	1.43 C/W	.99 C/W
	28	21mm	9.98 C/W	4.55 C/W	2.98 C/W	2.42 C/W		28	33mm	8.27 C/W	2.24 C/W	1.28 C/W	.87 C/W
903	12	23mm	12.06 C/W	5.72 C/W	3.95 C/W	3.24 C/W	908	12	35mm	10.03 C/W	3.06 C/W	1.97 C/W	1.49 C/W
	15	23mm	11.41 C/W	5.39 C/W	3.67 C/W	2.99 C/W		15	35mm	9.5 C/W	2.85 C/W	1.81 C/W	1.34 C/W
	18	23mm	10.76 C/W	5.05 C/W	3.35 C/W	2.67 C/W		18	35mm	8.98 C/W	2.6 C/W	1.64 C/W	1.19 C/W
	21	23mm	10.11 C/W	4.74 C/W	3.1 C/W	2.46 C/W		21	35mm	8.46 C/W	2.4 C/W	1.5 C/W	1.07 C/W
	23	23mm	9.99 C/W	4.44 C/W	2.87 C/W	2.31 C/W		23	35mm	8.32 C/W	2.19 C/W	1.34 C/W	.97 C/W
	28	23mm	9.70 C/W	4.09 C/W	2.62 C/W	2.12 C/W		28	35mm	7.99 C/W	1.97 C/W	1.19 C/W	.83 C/W
904	12	27mm	11.38 C/W	4.84 C/W	3.11 C/W	2.32 C/W	909	12	37.5mm	9.60 C/W	2.93 C/W	1.90 C/W	1.36 C/W
	15	27mm	10.78 C/W	4.48 C/W	2.84 C/W	2.12 C/W		15	37.5mm	9.11 C/W	2.71 C/W	1.72 C/W	1.19 C/W
	18	27mm	10.17 C/W	4.13 C/W	2.56 C/W	1.88 C/W		18	37.5mm	8.61 C/W	2.52 C/W	1.53 C/W	1.05 C/W
	21	27mm	9.56 C/W	3.82 C/W	2.32 C/W	1.72 C/W		21	37.5mm	8.11 C/W	2.25 C/W	1.36 C/W	.88 C/W
	23	27mm	9.44 C/W	3.51 C/W	2.11 C/W	1.6 C/W		23	37.5mm	7.98 C/W	2.04 C/W	1.2 C/W	.75 C/W
	28	27mm	9.13 C/W	3.26 C/W	1.97 C/W	1.49 C/W		28	37.5mm	7.63 C/W	1.82 C/W	1.01 C/W	.63 C/W
905	12	29mm	11.04 C/W	4.08 C/W	2.55 C/W	1.98 C/W	910	12	40mm	9.18 C/W	2.84 C/W	1.86 C/W	1.36 C/W
	15	29mm	10.46 C/W	3.82 C/W	2.32 C/W	1.78 C/W		15	40mm	8.71 C/W	2.64 C/W	1.65 C/W	1.18 C/W
	18	29mm	9.87 C/W	3.58 C/W	2.14 C/W	1.58 C/W		18	40mm	8.24 C/W	2.4 C/W	1.44 C/W	.98 C/W
	21	29mm	9.28 C/W	3.33 C/W	1.96 C/W	1.44 C/W		21	40mm	7.77 C/W	2.21 C/W	1.27 C/W	.86 C/W
	23	29mm	9.16 C/W	3.13 C/W	1.82 C/W	1.34 C/W		23	40mm	7.63 C/W	2 C/W	1.15 C/W	.73 C/W
	28	29mm	8.84 C/W	2.82 C/W	1.64 C/W	1.2 C/W		28	40mm	7.27 C/W	1.77 C/W	.99 C/W	.62 C/W

Material: AL 6063  
Finish: Black Anodize

Series	Chip Size	Construction	Height	Chip Height	Finish	Interface
901	19	2= Pin Fin	12 = 11.6 15 = 14.6 18 = 17.6 21 = 20.6 23 = 22.6 28 = 27.6 33 = 32.6	1 = .9-2.1 2 = 2.2-3.4	B = BLK ANO	0 = None 1 = T725
	21					
	23					
	27					
	29					
	31					
	33					
	35					
	37.5					

Refer to Page 33 for  
Installation Instructions

## X-ON Electronics

Largest Supplier of Electrical and Electronic Components

*Click to view similar products for [Heat Sinks](#) category:*

*Click to view products by [Wakefield](#) manufacturer:*

Other Similar products are found below :

[581102B00000G](#) [630-35ABT3](#) [656-15ABPE](#) [657-20ABPNE](#) [73452PPBA](#) [7G0011A](#) [A22-4026](#) [HAH10L](#) [218-40CTE3](#) [231-69PAB-15V](#)  
[231-75PAB-13V](#) [231-75PAB-15V](#) [253-122ABE-22](#) [PSC22CB](#) [CLP212SG](#) [HAF10L](#) [HAQ10T](#) [D10100-28](#) [TO5-002D](#) [BDN183CBA01](#) [3-](#)  
[21053-4](#) [TX0506-1B](#) [LAE66A3CB](#) [511-3U](#) [73381PPBA](#) [73403PPBA](#) [7G0047C](#) [8191-E40](#) [510-12M](#) [529802B00000](#) [D10650-40T5](#) [6225B-](#)  
[MT6G](#) [ATS-54310K-C2-R0](#) [648-51AB](#) [657-20ABPESC](#) [679-25AG](#) [FK 212 CB SA](#) [FK225 SA L1](#) [680-5K](#) [SK145 37 5STSTO220](#)  
[7109DG/TR](#) [S14K35G3S5](#) [8924G](#) [7717-133DAP](#) [7717-26DAP](#) [4509](#) [CLP-215](#) [SK 129 25,4 STC](#) [D20850-40-T2](#) [APF30-30-10CB/A01](#)