

APPROVAL SHEET

RFLPF Series – 1608(0603)- RoHS Compliance

MULTILAYER CERAMIC LOW PASS FILTER

Halogens Free Product

LTE B33/B34/B36/B37/B39 RF Application

P/N: RFLPF16081G8D78Q1C

*Contents in this sheet are subject to change without prior notice.

FEATURES

1. Miniature footprint: 1.6 X 0.8X 0.7 mm³.
2. Low Profile Thickness
3. Low Insertion loss
4. High attenuation on harmonic suppressed
5. LTCC process

APPLICATIONS

1. 1880 ~ 2025 MHz band Working Frequency.

CONSTRUCTION

Top view

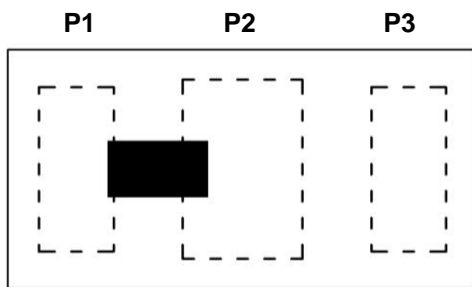

PIN	Connection
1	Input port
2	GND
3	Output port

DIMENSIONS

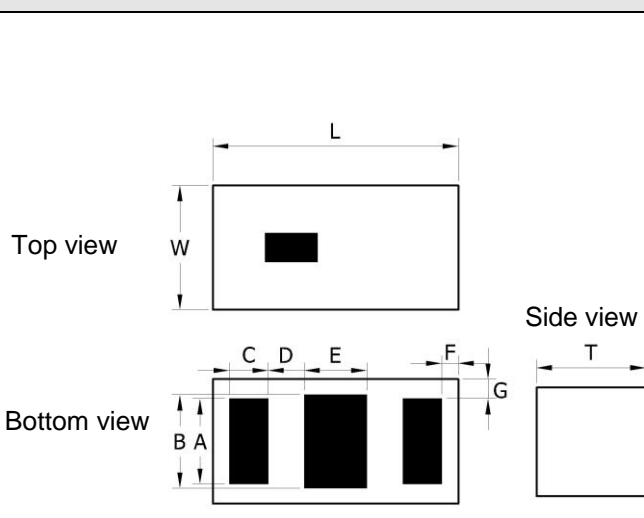
Figure	Symbol	Dimension (mm)
 <p>Top view</p> <p>Bottom view</p> <p>Side view</p>	L	1.60 ± 0.10
	W	0.80 ± 0.10
	T	0.7 max.
	A	0.55 ± 0.10
	B	0.60 ± 0.10
	C	0.25 ± 0.10
	D	0.23 ± 0.10
	E	0.40 ± 0.10
	F	0.12 ± 0.10
	G	0.125 ± 0.10

ELECTRICAL CHARACTERISTICS

RFLPF16081G8D78Q1C	Specification
Frequency Range	1880 ~ 2025 MHz
Insertion Loss	1.4 dB max. at +25 °C 1.7 dB max. at -40 ~ +85 °C
Attenuation	25.0 dB min. @ 2400 ~ 2500 MHz 18.0 dB min. @ 4020 ~ 4045 MHz 25.0 dB min. @ 6030 ~ 6075 MHz
VSWR	2.0 max.
Impedance	50 Ω
Power Capacity	2 W max.
Moisture sensitivity levels	MSL is LEVEL 1 (Refer to : IPC/JEDEC J-STD-020)

Operating & Storage Condition (Component)

Operation Temperature Range: -40 ~ +85 °C
Storage Temperature Range: -40 ~ +85 °C

Storage Condition before Soldering (Included packaging material)

Storage Temperature Range: +5 ~ +40 °C
Humidity: 30 to 70% relative humidity

Typical Electrical Chart

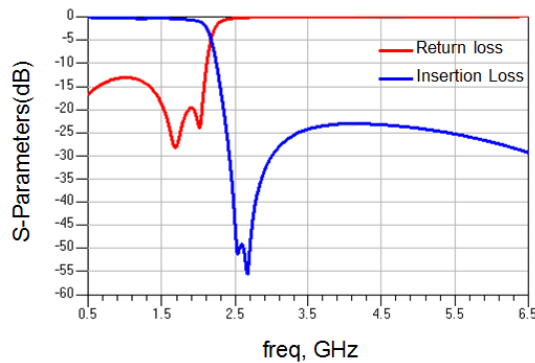

SOLDER LAND PATTERN

SOLDER LAND PATTERN

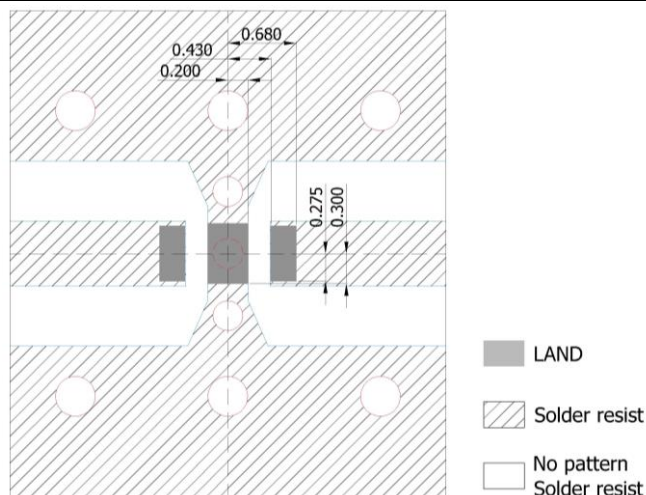

Unit : mm

Line width to be designed to match 50 Ω characteristic impedance, depending on PCB material and thickness.

RELIABILITY TEST

Test item	Test condition / Test method	Specification
Solderability JIS C 0050-4.6 JESD22-B102D	*Solder bath temperature : $235 \pm 5^{\circ}\text{C}$ *Immersion time : 2 ± 0.5 sec Solder : Sn3Ag0.5Cu for lead-free	At least 95% of a surface of each terminal electrode must be covered by fresh solder.
Leaching (Resistance to dissolution of metallization) IEC 60068-2-58	*Solder bath temperature : $260 \pm 5^{\circ}\text{C}$ *Leaching immersion time : 30 ± 0.5 sec Solder : SN63A	Loss of metallization on the edges of each electrode shall not exceed 25%.
Resistance to soldering heat JIS C 0050-5.4	*Preheating temperature : $120\sim 150^{\circ}\text{C}$, 1 minute. *Solder temperature : $270\pm 5^{\circ}\text{C}$ *Immersion time : 10 ± 1 sec Solder : Sn3Ag0.5Cu for lead-free Measurement to be made after keeping at room temperature for 24 ± 2 hrs	No mechanical damage. Electrical specification shall satisfy the descriptions in electrical characteristics under the operational temperature range within $-40\sim 85^{\circ}\text{C}$. Loss of metallization on the edges of each electrode shall not exceed 25%.
Drop Test JIS C 0044 Customer's specification.	*Height : 75 cm *Test Surface : Rigid surface of concrete or steel. *Times : 6 surfaces for each units ; 2 times for each side.	No mechanical damage. Electrical specification shall satisfy the descriptions in electrical characteristics under the operational temperature range within $-40\sim 85^{\circ}\text{C}$.
Vibration JIS C 0040	*Frequency : $10\text{Hz}\sim 55\text{Hz}\sim 10\text{Hz}(1\text{min})$ *Total amplitude : 1.5mm *Test times : 6hrs.(Two hrs each in three mutually perpendicular directions)	No mechanical damage. Electrical specification shall satisfy the descriptions in electrical characteristics under the operational temperature range within $-40\sim 85^{\circ}\text{C}$.
Adhesive Strength of Termination JIS C 0051- 7.4.3	*Pressurizing force : $5\text{N}(\leq 0603)$; $10\text{N}(>0603)$ *Test time : 10 ± 1 sec	No remarkable damage or removal of the termination.
Bending test JIS C 0051- 7.4.1	The middle part of substrate shall be pressurized by means of the pressurizing rod at a rate of about 1 mm/s per second until the deflection becomes 1mm/s and then pressure shall be maintained for 5 ± 1 sec. Measurement to be made after keeping at room temperature for 24 ± 2 hours	No mechanical damage. Electrical specification shall satisfy the descriptions in electrical characteristics under the operational temperature range within $-40\sim 85^{\circ}\text{C}$.

Approval sheet

<p>Temperature cycle JIS C 0025</p>	<p>1. 30±3 minutes at -40°C±3°C, 2. 10~15 minutes at room temperature, 3. 30±3 minutes at +85°C±3°C, 4. 10~15 minutes at room temperature, Total 100 continuous cycles Measurement to be made after keeping at room temperature for 24±2 hrs</p>	<p>No mechanical damage. Electrical specification shall satisfy the descriptions in electrical characteristics under the operational temperature range within -40 ~ 85°C.</p>
<p>High temperature JIS C 0021</p>	<p>*Temperature : 85°C±2°C *Test duration : 1000+24/-0 hours Measurement to be made after keeping at room temperature for 24±2 hrs</p>	<p>No mechanical damage. Electrical specification shall satisfy the descriptions in electrical characteristics under the operational temperature range within -40 ~ 85°C.</p>
<p>Humidity (steady conditions) JIS C 0022</p>	<p>*Humidity : 90% to 95% R.H. *Temperature : 40±2°C *Time : 1000+24/-0 hrs. Measurement to be made after keeping at room temperature for 24±2 hrs ※ 500hrs measuring the first data then 1000hrs data</p>	<p>No mechanical damage. Electrical specification shall satisfy the descriptions in electrical characteristics under the operational temperature range within -40 ~ 85°C.</p>
<p>Low temperature JIS C 0020</p>	<p>*Temperature : -40°C±2°C *Test duration : 1000+24/-0 hours Measurement to be made after keeping at room temperature for 24±2 hrs</p>	<p>No mechanical damage. Electrical specification shall satisfy the descriptions in electrical characteristics under the operational temperature range within -40 ~ 85°C.</p>

SOLDERING CONDITION

Typical examples of soldering processes that provide reliable joints without any damage are given in Fig 2,

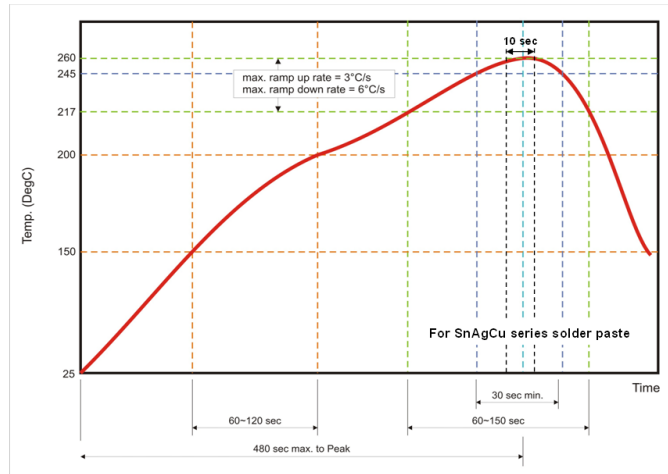

Fig 2. Infrared soldering profile

ORDERING CODE

RF	LPF	1608	1G8	D	78Q1C
Walsin RF device	Product Code LPF : Low Pass Filter	Dimension code Per 2 digits of Length, Width : e.g. : 1608 = Length 16, Width 08,	Central Frequency 1G8 :1.8 GHz	Application D :GSM900 / DCS1800	Specification Design code

Minimum Ordering Quantity: 4000 pcs per reel.

PACKAGING

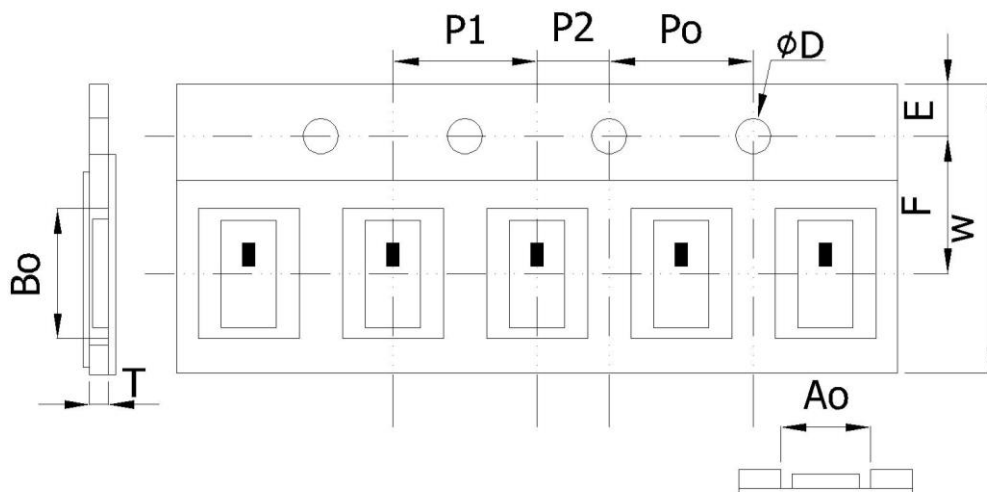

Paper Tape specifications (unit :mm)

Index	Ao	Bo	φD	T	W
Dimension (mm)	0.975± 0.05	1.76 ±0.05	1.55 + 0.05	0.75± 0.10	8.0 ± 0.10
Index	E	F	Po	P1	P2
Dimension (mm)	1.75 ± 0.10	3.50 ± 0.05	4.00 ± 0.10	4.00 ± 0.10	2.00 ± 0.05

Reel dimensions

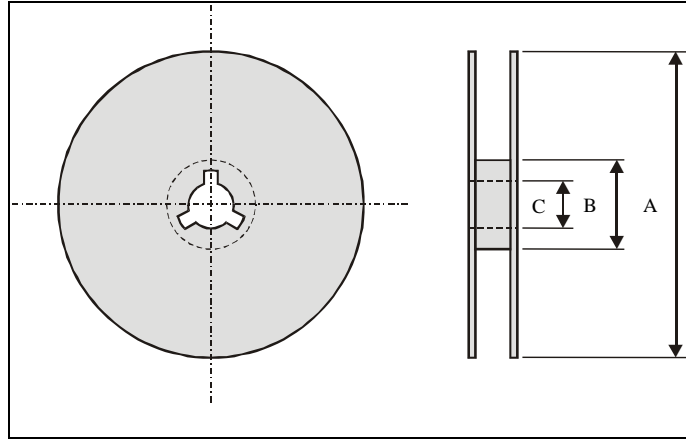

Index	A	B	C
Dimension (mm)	Φ178.0	Φ60.0	Φ13.0

Taping Quantity:4000 pieces per 7" reel

CAUTION OF HANDLING

Limitation of Applications

Please contact us before using our products for the applications listed below which require especially high reliability for the prevention of defects, which might directly cause damage to the third party's life, body or property.

- (1) Aircraft equipment
- (2) Aerospace equipment
- (3) Undersea equipment
- (4) Medical equipment
- (5) Disaster prevention / crime prevention equipment
- (6) Traffic signal equipment
- (7) Transportation equipment (vehicles, trains, ships, etc.)
- (8) Applications of similar complexity and /or reliability requirements to the applications listed in the above.

Storage condition

- (1) Products should be used in 6 months from the day of WALSIN outgoing inspection.
- (2) Storage environment condition.
 - Products should be storage in the warehouse on the following conditions.
 - Temperature : +5 to +40°C
 - Humidity : 30 to 70% relative humidity
 - Don't keep products in corrosive gases such as sulfur. Chlorine gas or acid or it may cause oxidization of electrode, resulting in poor solderability.
 - Products should be storage on the palette for the prevention of the influence from humidity, dust and son on.
 - Products should be storage in the warehouse without heat shock, vibration, direct sunlight and so on.
 - Products should be storage under the airtight packaged condition.

X-ON Electronics

Largest Supplier of Electrical and Electronic Components

Click to view similar products for [Signal Conditioning](#) category:

Click to view products by [Walsin](#) manufacturer:

Other Similar products are found below :

[MAPDCC0004](#) [PD0409J5050S2HF](#) [880157](#) [HHS-109-PIN](#) [DC1417J5005AHF](#) [DC4859J5005AHF](#) [AFS14A30-2185.00-T3](#) [AFS14A35-1591.50-T3](#) [DS-323-PIN](#) [DSS-313-PIN](#) [B39321R801H210](#) [B39321R821H210](#) [B39921B4317P810](#) [1A0220-3](#) [2089-6207-00](#) [JP510S](#) [LFB212G45SG8C341](#) [LFB322G45SN1A504](#) [LFL182G45TC3B746](#) [SF2159E](#) [30057](#) [1P510S](#) [CER0813B](#) [3A325](#) [40287](#) [41180](#) [ATB3225-75032NCT](#) [B69842N5807A150](#) [BD0810N50100AHF](#) [BD2326L50200AHF](#) [BD2425J50200AHF](#) [HMC189AMS8TR](#) [C5060J5003AHF](#) [JHS-114-PIN](#) [JP503AS](#) [DC0710J5005AHF](#) [DC2327J5005AHF](#) [DC3338J5005AHF](#) [43020](#) [LFB2H2G60BB1C106](#) [LFL15869MTC1B787](#) [X3C19F1-20S](#) [XC3500P-20S](#) [10013-20](#) [SF2081E](#) [SF2194E](#) [SF2238E](#) [CDBLB455KCAX39-B0](#) [RF1353C](#) [PD0922J5050D2HF](#)