

# APPROVAL SHEET

## **WA04, WA06**

**$\pm 1\%$ ,  $\pm 5\%$ , Convex Type & Concave Type**

General purpose chip resistors array

Size 0402x2 (4p2R)

Size 0402x4, 0603x4 (8p4R)

Size 0602x8 (16p8R)

\*Contents in this sheet are subject to change without prior notice.

## FEATURE

1. Small size and light weight
2. Reduced size of final equipment
3. Lower surface mounted assembly costs
4. Higher component and equipment reliability
5. RoHS compliant and lead free products.

## APPLICATION

- Consumer electrical equipment
- EDP, Computer application
- Telecom

## DESCRIPTION

The resistors array is constructed in a high grade ceramic body (aluminum oxide). Internal metal electrodes are added at each end and connected by a resistive paste that is applied to the top surface of the substrate. The composition of the paste is adjusted to give the approximate resistance required and the value is trimmed to within tolerance by laser cutting of this resistive layer.

The resistive layer is covered with a protective coat. Finally, the two external end terminations are added. For ease of soldering the outer layer of these end terminations is Tin (lead free) alloy.



Fig 1. Construction of a Chip-R array (convex Type)

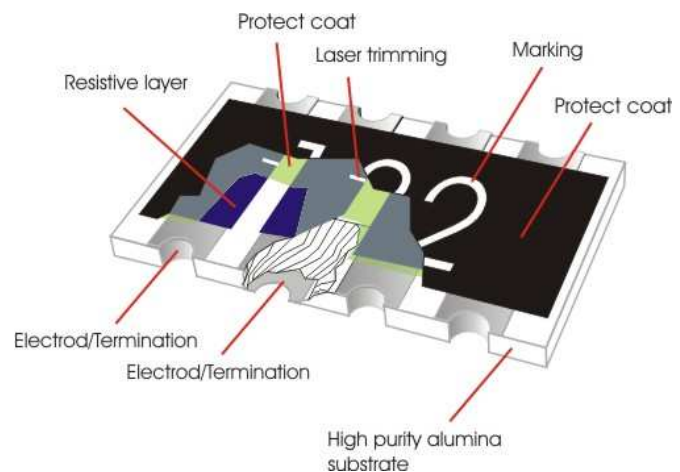

Fig 2. Construction of a Chip-R array (concave Type)

**QUICK REFERENCE DATA**

Item	General Specification								
	WA04Y(Convex)	WA04X(Convex)		WA06X(Convex)		WA06W(Convex)		WA06T(Concave)	
Series No.	WA04Y(Convex)	WA04X(Convex)		WA06X(Convex)		WA06W(Convex)		WA06T(Concave)	
Size	0402x2 (1005x2)	0402x4 (1005x4)		0603x4 (1608x4)		0602x8 (1605x8)		0603x4 (1608x4)	
Resistance Tolerance	±5%	±1%	±5%	±1%	±5%	±1%	±5%	±1%	±5%
Resistance Range	3Ω ~ 1MΩ, Jumper	10Ω ~ 1MΩ	3Ω ~ 1MΩ Jumper	10Ω ~ 1MΩ	1Ω ~ 10MΩ Jumper,	10Ω ~ 100KΩ,	10Ω ~ 100KΩ Jumper,	10Ω ~ 1MΩ,	10Ω ~ 1MΩ, Jumper
TCR (ppm/°C) 10Ω ≤ R ≤ 1MΩ R < 10Ω, R > 1MΩ	≤ ± 300 ≤ ± 400	≤ ± 200 -	≤ ± 200 -300~+500	≤ ± 100 -	≤ ± 200 -300~+500	≤ ± 200 -	≤ ± 200 -	≤ ± 200 -	≤ ± 200 -
Max. dissipation at T <sub>amb</sub> =70°C	1/16 W	1/16 W		1/10 W		1/16 W		1/10 W	
Max. Operation Voltage (DC or RMS)	25V	50V		50V		50V		50V	
Max. overload voltage	50V	100V		100V		100V		100V	
Climatic category	55/155/56					55/155/56		55/155/56	

Note :

1. Climatic category refer to IEC 60068
2. This is the maximum voltage that may be continuously supplied to the resistor element, see "IEC publication 60115-8"
3. Max. Operation Voltage : So called RCWV (Rated Continuous Working Voltage) is determined by

$$RCWV = \sqrt{\text{Rated Power} \times \text{Resistance Value}} \text{ or Max. RCWV listed above, whichever is lower.}$$

**DIMENSIONS (unit : mm)**

	WA04Y
L	1.00 ± 0.10
W	1.00 ± 0.10
T	0.35 ± 0.10
P	0.65 ± 0.10
A	0.34 ± 0.10
Ta	0.20 ± 0.15
Tb	0.25 ± 0.17

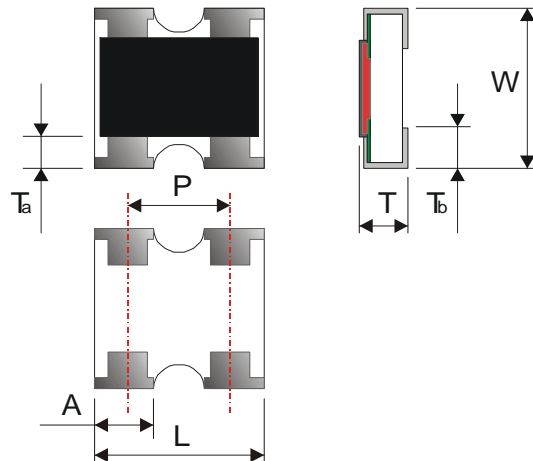

	WA04X	WA06X
L	2.00 ± 0.10	3.20 ± 0.10
W	1.00 ± 0.10	1.60 ± 0.10
T	0.45 ± 0.10	0.50 ± 0.10
P	0.50 ± 0.05	0.80 ± 0.10
A	0.40 ± 0.10	0.60 ± 0.10
B	0.20 ± 0.10	0.30 ± 0.10
C	0.30 ± 0.05	0.40 ± 0.10
G	0.25 ± 0.10	0.30 ± 0.20

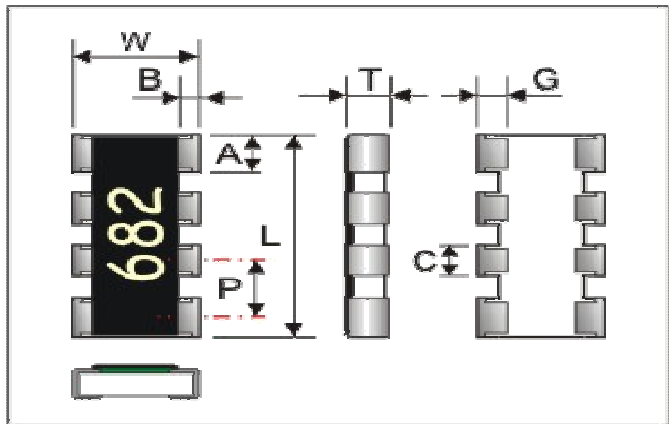

	WA06W
L	4.00 ± 0.20
W	1.60 ± 0.15
T	0.45 ± 0.10
B	0.30 ± 0.20
G	0.30 ± 0.20
D	0.20 ± 0.10
P	0.50 ± 0.20
H1	0.40 ± 0.20
H2	0.30 ± 0.10

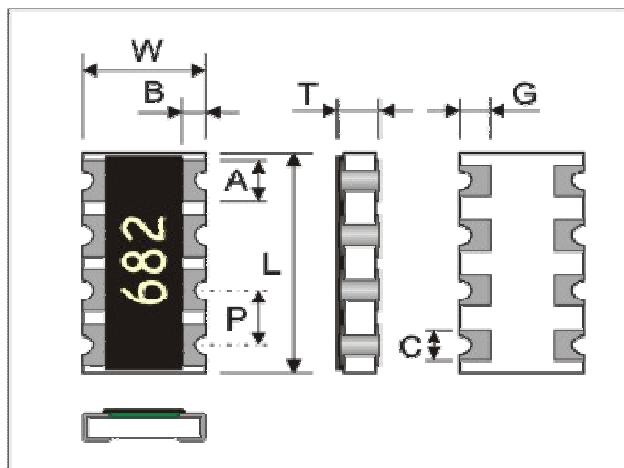
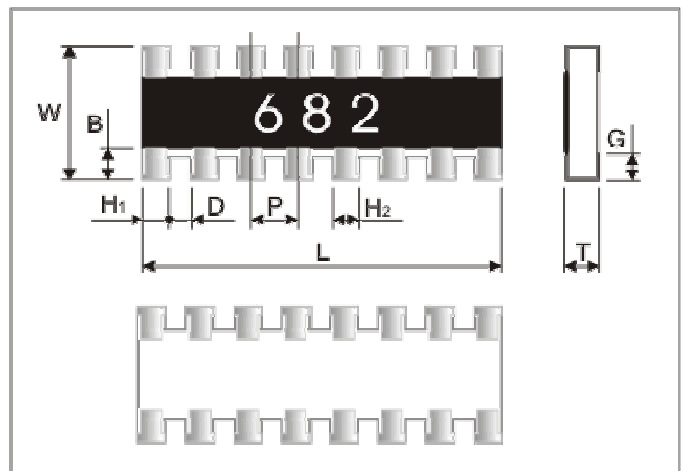

	WA06T
L	3.20+0.20/-0.10
W	1.60+0.20/-0.10
T	0.60 ± 0.10
P	0.80 ± 0.10
A	0.60 ± 0.15
B	0.35 ± 0.15
C	0.50 ± 0.15
G	0.50 ± 0.15

## MARKING

### 3-digits marking for E24 series 1% ,5% products

Each resistor is marked with a three digits code on the protective coating to designate the nominal resistance value. For values up to 9.1 the R is used as a decimal point. For values of 10.0 or greater the first 2 digits apply to the resistance value and third indicate the number of zeros to follow.

#### Example

<b>RESISTANCE</b>	4.7Ω	10Ω	100Ω	6800Ω	47000Ω
<b>3-digits marking</b>	4R7	100	101	682	473

No marking for WA04Y chip resistors array and E96 series resistance.

## FUNCTIONAL DESCRIPTION

### Product characterization

Standard values of nominal resistance are taken from the E24 series for resistors with a tolerance of  $\pm 5\%$ , The values of the E24 series are in accordance with "IEC publication 60063"

Standard values of nominal resistance are taken from the E24/E96 series for resistors with a tolerance of  $\pm 1\%$ , The values of the E24/E96 series are in accordance with "IEC publication 60063"

### Derating

The power that the resistor can dissipate depends on the operating temperature; see Fig.3.

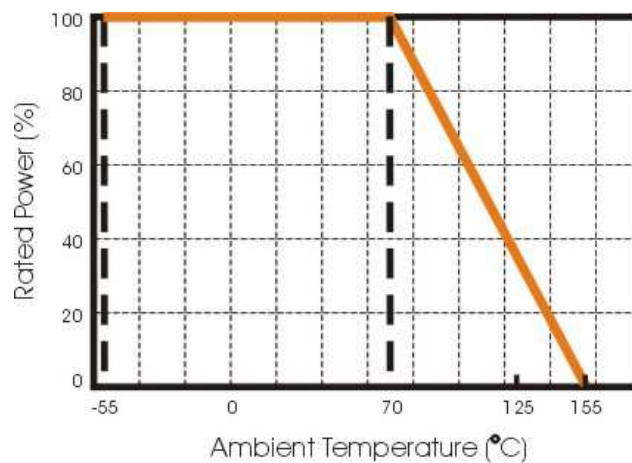
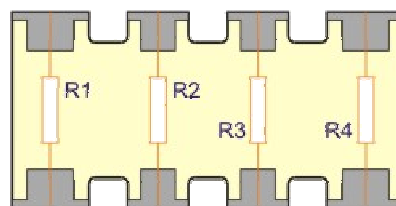

Figure 3 Maximum dissipation in percentage of rated power as a function of the ambient temperature

## CONSTRUCTION



$$R1=R2=R3=R4$$

## MOUNTING

Due to their rectangular shapes and small tolerances, Surface Mountable Resistors are suitable for handling by automatic placement systems.

Chip placement can be on ceramic substrates and printed-circuit boards (PCBs).

Electrical connection to the circuit is by individual soldering condition.

The end terminations guarantee a reliable contact.

## SOLDERING CONDITION

The robust construction of chip resistors allows them to be completely immersed in a solder bath of 260°C for 10 seconds. Therefore, it is possible to mount Surface Mount Resistors on one side of a PCB and other discrete components on the reverse (mixed PCBs).

Surface Mount Resistors are tested for solderability at 235°C during 2 seconds. The test condition for no leaching is 260°C for 30 seconds. Typical examples of soldering processes that provide reliable joints without any damage are given in Fig 4.



Fig 4. Infrared soldering profile for Chip Resistors array

### TEST AND REQUIREMENTS(JIS C 5201-1 : 1998)

Essentially all tests are carried out according to the schedule of IEC publication 115-8, category **LCT/UCT/56**(rated temperature range : **Lower Category Temperature, Upper Category Temperature**; damp heat, long term, 56 days). The testing also meets the requirements specified by EIA, EIAJ and JIS.

The tests are carried out in accordance with IEC publication 68, "Recommended basic climatic and mechanical robustness testing procedure for electronic components" and under standard atmospheric conditions according to IEC 60068-1, subclause 5.3. Unless otherwise specified, the following value supplied :

Temperature: 15°C to 35°C.

Relative humidity: 45% to 75%.

Air pressure: 86kPa to 106 kPa (860 mbar to 1060 mbar).

All soldering tests are performed with mildly activated flux.

TEST	PROCEDURE	REQUIREMENT	
		Resistor	Jumper
DC resistance <b>Clause 4.5</b>	DC resistance values measured at the test voltages specified below : <10Ω@0.1V,<100Ω@0.3V,<1KΩ@1.0V,<10KΩ@3V, <100KΩ@10V, <1MΩ@25V, <10MΩ@30V	Within the specified tolerance	< 50mΩ
Temperature Coefficient of Resistance (T.C.R) <b>Clause 4.8</b>	Natural resistance change per change in degree centigrade. $\frac{R_2 - R_1}{R_1(t_2 - t_1)} \times 10^6 \text{ (ppm/°C)}$ $t_1 : 20^\circ\text{C}+5^\circ\text{C}-1^\circ\text{C}$ R <sub>1</sub> : Resistance at reference temperature R <sub>2</sub> : Resistance at test temperature	Refer to "QUICK REFERENCE DATA"	N/a
Short time overload (S.T.O.L) <b>Clause 4.13</b>	Permanent resistance change after a 5second application of a voltage 2.5 times RCWV or the maximum overload voltage specified in the above list, whichever is less.	ΔR/R max. ±(2%+0.10Ω)	< 50mΩ
Resistance to soldering heat(R.S.H) <b>Clause 4.18</b>	Un-mounted chips completely immersed for 10±1second in a SAC solder bath at 260°C±5°C	Δ R/R max. ±(1%+0.05Ω) no visible damage	< 50mΩ
Solderability <b>Clause 4.17</b>	Un-mounted chips completely immersed for 2±0.5 second in a SAC solder bath at 235°C±5°C	good tinning (>95% covered) no visible damage	
Temperature cycling <b>Clause 4.19</b>	30 minutes at -55°C±3°C, 2~3 minutes at 20°C+5°C-1°C, 30 minutes at +155°C±3°C, 2~3 minutes at 20°C+5°C-1°C, total 5 continuous cycles	Δ R/R max. ±(1%+0.05Ω) no visible damage	< 50mΩ
Load life (endurance) <b>Clause 4.25</b>	1000 +48/-0 hours, loaded with RCWV or Vmax in chamber controller 70±2°C, 1.5 hours on and 0.5 hours off	Δ R/R max.±(3%+0.10Ω) For 10Ω≤R<1MΩ ; Δ R/R max.±(5%+0.10Ω) For R<10Ω, R≥1MΩ	< 50mΩ
Load life in Humidity <b>Clause 4.24</b>	1000 +48/-0 hours, loaded with RCWV or Vmax in humidity chamber controller at 40°C±2°C and 90~95% relative humidity, 1.5hours on and 0.5 hours off	Δ R/R max.±(3%+0.10Ω) For 10Ω≤R<1MΩ ; Δ R/R max.±(5%+0.10Ω) For R<10Ω, R≥1MΩ	< 50mΩ
Adhesion <b>Clause 4.32</b>	Pressurizing force: 5N, Test time: 10±1sec.	No remarkable damage or removal of the terminations.	
Insulation Resistance <b>Clause 4.6</b>	Apply the maximum overload voltage (DC) for 1minute	R ≥ 10G Ω	
Dielectric Withstand Voltage <b>Clause 4.7</b>	Apply the maximum overload voltage (AC) for 1 minute	No breakdown or flashover	

### TEST CONDITION FOR JUMPER (0 Ω)

Item	WA04Y	WA04X	WA06X	WA06W	WA06T
Power Rating At 70°C	1/16W	1/16W	1/10W	1/16W	1/10W
Resistance	MAX.50mΩ	MAX.50mΩ	MAX.50mΩ	MAX.50mΩ	MAX.50mΩ
Rated Current	1A	1A	1A	2A	1A
Peak Current	1.5A	1.5A	3A	3A	3A
Operating Temperature	-55~155°C	-55~155°C	-55~155°C	-55~155°C	-55~155°C

### CATALOGUE NUMBERS

The resistors have a catalogue number starting with .

WA	X	XXXX	X	X	L
<b>Size code</b>	<b>Type code</b>	<b>Resistance code</b>	<b>Tolerance</b>	<b>Packaging code</b>	<b>Termination code</b>
06: 0603 (1608) 04:0402(1005)	X : x 4, Convex Y : x 2, Convex W :x 8, Convex T : x 4, Concave	<b>5% E24</b> : 2 significant digits followed by no. of zeros and a blank  4.7Ω =4R7_ 10Ω =100_ 220Ω =221_ Jumper =000_ ("_" means a blank)  <b>1%, E24+E96</b> : 3 significant digits followed by no. of zeros  100Ω =1000 37.4KΩ =3742	F: ±1% J : ±5% P : Jumper	T : 7" Reel taping B : Bulk	L = Sn base (lead free)

WA06X, WA06T

1. Reeled tape packaging : 8mm width paper taping 5000pcs per reel.
2. Bulk packaging : 5000pcs per polybag

WA06W

1. Reeled tape packaging : 12mm width paper taping 5000pcs per reel.
2. Bulk packaging : 5000pcs per polybag

WA04X, WA04Y

1. Reeled tape packaging : 8mm width paper taping 10,000pcs per reel.



**PACKAGING**

Paper Tape specifications (unit :mm)



Symbol	A	B	W	F	E
WA06X,WA06T	3.60±0.20	2.00±0.20	8.00±0.30	3.50±0.20	1.75±0.10
WA04X	2.20±0.20	1.20±0.20		3.50±0.05	
WA04Y	1.15±0.10	1.15±0.10			
WA06W	4.20 <sup>+0.2</sup> <sub>-0.0</sub>	1.80 <sup>+0.12</sup> <sub>-0.0</sub>	12.00±0.10	5.50±0.05	1.75±0.10

Symbol	P1	P0	ΦD	T
WA06X,WA06T	4.00±0.10	4.00±0.10	Φ1.50 <sup>+0.1</sup> <sub>-0.0</sub>	Max. 1.0
WA04X	2.00±0.05			Max. 0.6
WA04Y				0.45±0.05
WA06W	4.00±0.10		∅D1.55±0.05	0.80±0.05

**Reel dimensions**

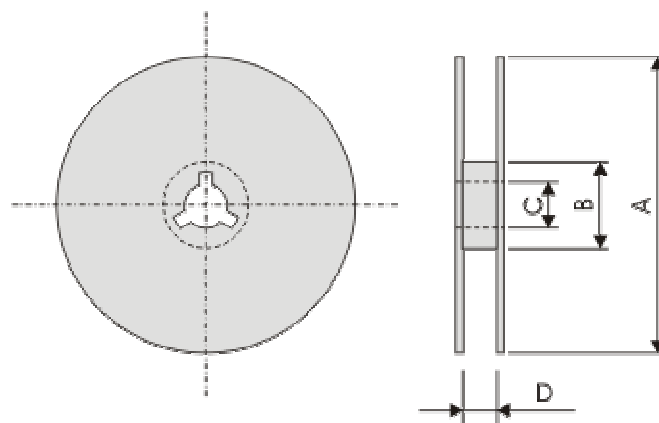

Symbol	A	B	C	D
WA06X,WA04Y,WA04X,WA06T	Φ178.0±2.0	Φ60.0±1.0	13.0±0.2	9.0±0.5
WA06W	Φ178.0±2.0	Φ60.0±1.0	13.0±0.2	12.4±1.0

## X-ON Electronics

Largest Supplier of Electrical and Electronic Components

*Click to view similar products for [Resistor Networks & Arrays](#) category:*

*Click to view products by [Walsin](#) manufacturer:*

Other Similar products are found below :

[CS6600552K000B8768](#) [CSC06A0122K0GEJ](#) [M8340105K1002FGD03](#) [M8340105M4700JGD03](#) [M8340106M2002GCD03](#)  
[M8340107K1471FGD03](#) [M8340107K2261FGD03](#) [M8340107M1501GGD03](#) [M8340108K1001FCD03](#) [M8340108K2402GGD03](#)  
[M8340108K3240FGD03](#) [M8340108K3242FGD03](#) [M8340108K3322FCD03](#) [M8340109K2002FCD03](#) [M8340109K4700GGD03](#)  
[M8340109M4701GCD03](#) [M8340109MA010GHD03](#) [EXB-24N121JX](#) [EXB-24N330JX](#) [EXB-24N470JX](#) [744C083101JTR](#) [EXB-U14360JX](#)  
[EXB-U18240JX](#) [744C083270JTR](#) [745C102472JP](#) [745X101103JP](#) [767161104G](#) [MDP1603100KGE04](#) [770101223](#) [MNR04M0APJ471](#)  
[MNR14E0APJ100](#) [MNR18E0APJ102](#) [MNR18E0APJ680](#) [ACAS06S0830339P100](#) [ACAS06S0830343P100](#) [ACAS06S0830344P100](#)  
[RAVF164DJT68K0](#) [RM2012A-102/104-PBVW10](#) [RM2012A-102503-PBVW10](#) [RM2012A-502104-PBVW10](#) [NRSN04I4J220TRF](#)  
[NRSNA4I4J330TRF](#) [8B472TR4](#) [ACAS06S0830341P100](#) [ACAS06S0830342P100](#) [ACAS06S0830345P100](#) [EXB-18N390JX](#) [EXB-U14220JX](#)  
[EXB-U14470JX](#) [EXB-U18330JX](#)