

APPROVAL SHEET

**WF25Q/R, WF20Q/R, WF10Q/R, WF12Q/R,
WF08Q/R, WF06Q/R, WF04Q/R, WF02Q/R.**

**$\pm 1\%$, $\pm 0.5\%$, $\pm 0.25\%$, $\pm 0.1\%$, $\pm 0.05\%$,
 $\pm 0.02\%$, $\pm 0.01\%$**

TC50 , TC25

High Precision Power Thin Film Chip Resistors

Size: 2512, 2010, 1210, 1206, 0805, 0603,
0402, 0201



*Contents in this sheet are subject to change without prior notice.

FEATURE

1. SMD metal film resistor
2. High reliability and stability of 0.5% and below per customer request
3. High performance of TCR: 50 & 25 ppm/°C and below per customer request
4. Low current noise
5. RoHS compliant and lead free

APPLICATION

- Medical equipment
- Measuring instrument
- Communication device
- Computer
- Printer

DESCRIPTION

The resistors are constructed in a high grade ceramic body (aluminum oxide). Internal metal electrodes are added at each end and connected by a resistive layer that is applied to the top surface of the substrate. The composition of the resistive layer is adjusted to give the approximate resistance required and the value is trimmed to nominated value within tolerance which controlled by laser trimming of this resistive layer.

The resistive layer is covered with a protective coat. Finally, the two external end terminations are added. For environmental soldering issue, the outer layer of these end terminations is a Lead-free solder .

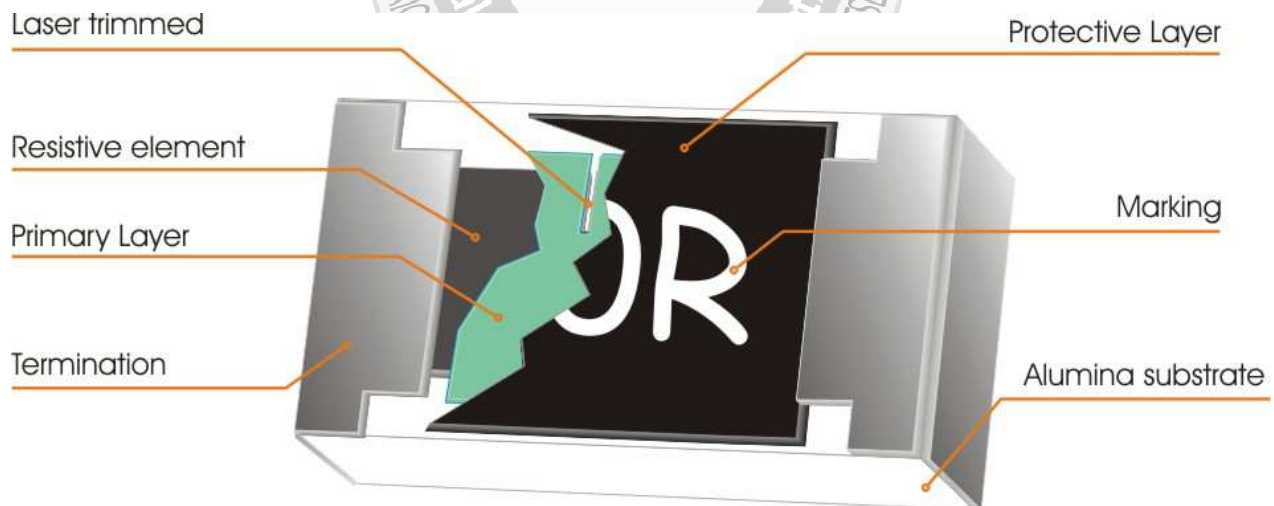

Fig 1. Construction of Chip-R WFxxQ/R

QUICK REFERENCE DATA

| Item | General Specification | | | | | | | | |
|-----------------------------------------------|-----------------------------------------------------|----------------|-----------------|----------------|----------------|----------------|----------------|------------------|-------------|
| Series No. | WF25Q &R | WF20Q &R | WF10Q &R | WF12Q &R | WF08Q &R | WF06Q &R | WF04Q &R | WF02Q&R | |
| Size Code | 2512 (6432) | 2010 (5025) | 1210 (3225) | 1206 (3216) | 0805 (2012) | 0603 (1608) | 0402 (1005) | 0201 (0603) | |
| Resistance Tolerance | ±1.0%, ±0.5%, ±0.25%, ±0.1%, ±0.05%, ±0.02%, ±0.01% | | | | | | | ± 1.0% ± 0.5% | |
| Resistance Range | 1Ω ~ 3MΩ | 4.7Ω ~ 3MΩ | 4.7Ω ~ 2.5MΩ | 1Ω ~ 2.5MΩ | 4.7Ω ~ 2MΩ | 3.9Ω ~ 1MΩ | 10Ω ~ 255KΩ | 27~ 22.1KΩ | 27~ 12KΩ |
| TCR | ± 50 / 25 ppm/°C | | | | | | | ±50 | ±25 |
| Max. Dissipation at T _{amb} =70°C | 1W | 3/4W | 2/5W | 1/4W | 1/8W | 1/10W | 1/10W | 1/20W | |
| Max. Operating Voltage | 200V | 200V | 200V | 200V | 150V | 75V | 50V | 15V | |
| Max. Overload Voltage | 400V | 400V | 400V | 400V | 300V | 150V | 100V | 30V | |
| Operating Temperature | - 55~ +155°C | | | | | | | | |

Note:

1. This is the maximum voltage that may be continuously supplied to the resistor element, see "IEC publication 60115-8"
2. Max. Operation Voltage : So called RCWV (Rated Continuous Working Voltage) is determined by

$$RCWV = \sqrt{\text{Rated Power} \times \text{Resistance Value}} \text{ or Max. RCWV listed above, whichever is lower.}$$

DIMENSIONS :(unit: mm)

| Type | WF25 | WF20 | WF10 | WF12 | WF08 | WF06 | WF04 | WF02 |
|------|-------------|-------------|-------------|-------------|-------------|-------------|-------------|-------------|
| L | 6.35 ± 0.10 | 5.00 ± 0.10 | 3.10 ± 0.10 | 3.05 ± 0.15 | 2.00 ± 0.10 | 1.55 ± 0.10 | 1.00 ± 0.10 | 0.60 ± 0.03 |
| W | 3.20 ± 0.15 | 2.50 ± 0.15 | 2.60 ± 0.15 | 1.55 ± 0.15 | 1.25 ± 0.10 | 0.80 ± 0.10 | 0.50 ± 0.05 | 0.30 ± 0.03 |
| A | 0.60 ± 0.20 | 0.60 ± 0.20 | 0.50 ± 0.20 | 0.40 ± 0.20 | 0.25 ± 0.20 | 0.30 ± 0.15 | 0.30 ± 0.15 | 0.10 ± 0.05 |
| B | 0.90 ± 0.25 | 0.60 ± 0.25 | 0.50 ± 0.20 | 0.40 ± 0.20 | 0.40 ± 0.20 | 0.30 ± 0.15 | 0.30 ± 0.15 | 0.15 ± 0.05 |
| t | 0.55 ± 0.10 | 0.55 ± 0.10 | 0.55 ± 0.10 | 0.55 ± 0.15 | 0.50 ± 0.15 | 0.45 ± 0.15 | 0.35 ± 0.05 | 0.23 ± 0.03 |

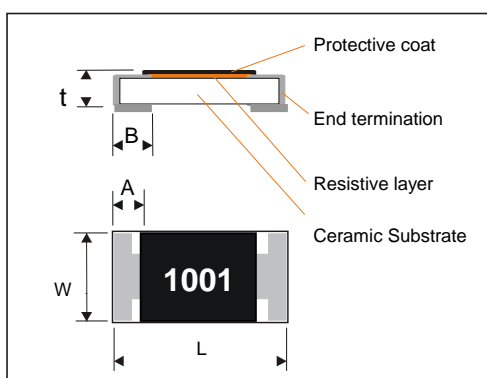

MARKING

- **3-digits marking for 0603 size**

WFxxQ/R has same marking rule as WRxx ±1%.

| Nominal resistance | | Description | | | | | | | | | | | | | |
|--------------------|---------|---------------------------------------------------------------------------------------------------------------------------------------------------------------------------------------------------------------------------------------------------------------------------------------------------------------------------------------------------------|---------|------|---------|------|---------|------|---------|------|---------|------|---------|------|---------|
| 1.E-24 series | | As 0603 WR06X ±5%. | | | | | | | | | | | | | |
| 2.E-96 series | | The 1st two digit codes are referring to the CODE on the table, the 3rd code is the index of resistance value : Y=10 ⁻² , X=10 ⁻¹ , A=10 ⁰ , B=10 ¹ , C=10 ² , D=10 ³ , E=10 ⁴ , F=10 ⁵ EX: 17.8Ω=25X, 178Ω=25A, 1K78=25B 17K8=25C, 178K=25D, 1M78=25E | | | | | | | | | | | | | |
| 3. Remark | | There is no marking for the items are not under E-24 and E-96 series | | | | | | | | | | | | | |
| CODE | R_value | CODE | R_value | CODE | R_value | CODE | R_value | CODE | R_value | CODE | R_value | CODE | R_value | CODE | R_value |
| 01 | 100 | 13 | 133 | 25 | 178 | 37 | 237 | 49 | 316 | 61 | 422 | 73 | 562 | 85 | 750 |
| 02 | 102 | 14 | 137 | 26 | 182 | 38 | 243 | 50 | 324 | 62 | 432 | 74 | 576 | 86 | 768 |
| 03 | 105 | 15 | 140 | 27 | 187 | 39 | 249 | 51 | 332 | 63 | 442 | 75 | 590 | 87 | 787 |
| 04 | 107 | 16 | 143 | 28 | 191 | 40 | 255 | 52 | 340 | 64 | 453 | 76 | 604 | 88 | 806 |
| 05 | 110 | 17 | 147 | 29 | 196 | 41 | 261 | 53 | 348 | 65 | 464 | 77 | 619 | 89 | 825 |
| 06 | 113 | 18 | 150 | 30 | 200 | 42 | 267 | 54 | 357 | 66 | 475 | 78 | 634 | 90 | 845 |
| 07 | 115 | 19 | 154 | 31 | 205 | 43 | 274 | 55 | 365 | 67 | 487 | 79 | 649 | 91 | 866 |
| 08 | 118 | 20 | 158 | 32 | 210 | 44 | 280 | 56 | 374 | 68 | 499 | 80 | 665 | 92 | 887 |
| 09 | 121 | 21 | 162 | 33 | 215 | 45 | 287 | 57 | 383 | 69 | 511 | 81 | 681 | 93 | 909 |
| 10 | 124 | 22 | 165 | 34 | 221 | 46 | 294 | 58 | 392 | 70 | 523 | 82 | 698 | 94 | 931 |
| 11 | 127 | 23 | 169 | 35 | 226 | 47 | 301 | 59 | 402 | 71 | 536 | 83 | 715 | 95 | 953 |
| 12 | 130 | 24 | 174 | 36 | 232 | 48 | 309 | 60 | 412 | 72 | 549 | 84 | 732 | 96 | 976 |

- **4-digits marking for 2512, 2010, 1210, 1206, 0805 size**

For E24+E96, each resistor is marked with a four digits code on the protective coating to designate the nominal resistance value. For values below 97Ω the R is used as a digit. For values of 100Ω or greater, the first 3 digits are significant, the fourth digit indicates the number of multiple to follow.

Example

| RESISTANCE | 100Ω | 6800Ω | 47000Ω |
|------------------|------|-------|--------|
| 4-digits marking | 1000 | 6801 | 4702 |

- **No marking code for 0402 and 0201 size**

FUNCTIONAL DESCRIPTION

Product characterization

Standard values of nominal resistance are taken from the E192 & E24 series for resistors with a tolerance of ±1.0%, ±0.5%, ±0.25%, ±0.1%. The values of the E24/E192 series are in accordance with "IEC publication 60063".

DERATING

The power that the resistor can dissipate depends on the operating temperature; see Fig.2

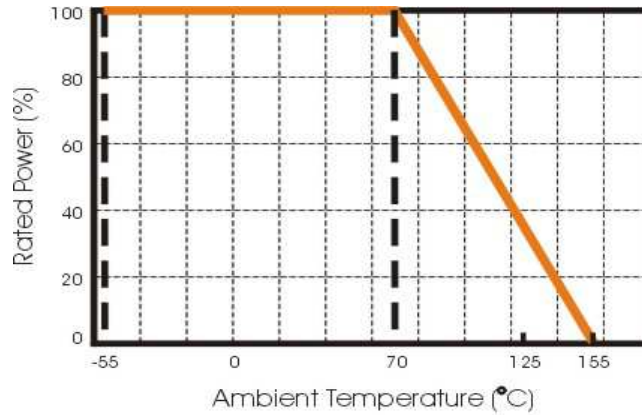

Fig.2 Maximum dissipation in percentage of rated power
As a function of the ambient temperature

MOUNTING

Due to their rectangular shapes and small tolerances, Surface Mountable Resistors are suitable for handling by automatic placement systems.

Chip placement can be on ceramic substrates and printed-circuit boards (PCBs).

Electrical connection to the circuit is by individual soldering condition.

The end terminations guarantee a reliable contact.

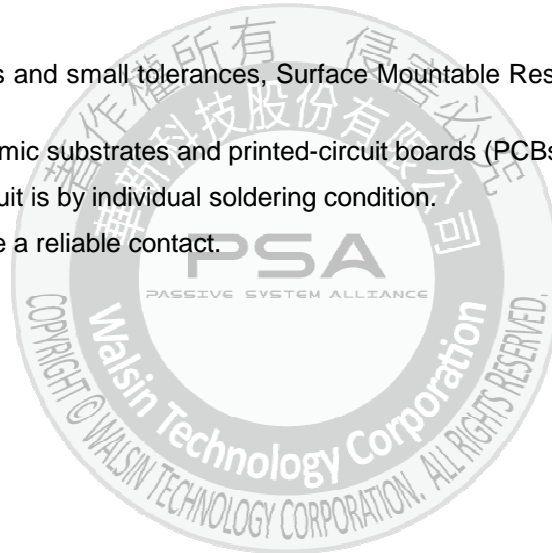

SOLDERING CONDITION

The robust construction of chip resistors allows them to be completely immersed in a solder bath of 260°C for 10 seconds. Therefore, it is possible to mount Surface Mount Resistors on one side of a PCB and other discrete components on the reverse (mixed PCBs).

Surface Mount Resistors are tested for solderability at 235°C during 2 seconds within lead-free solder bath. The test condition for no leaching is 260°C for 30 seconds. Typical examples of soldering profile and condition that provide reliable joints without any damage are given in Fig 3. and Table 1.

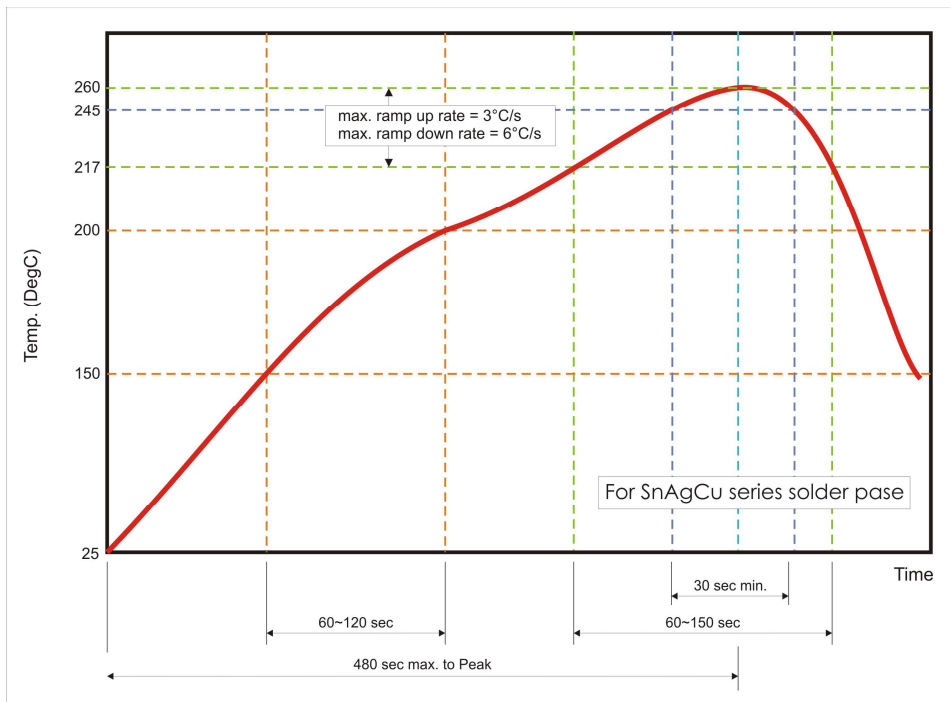

Fig. 3 Infrared soldering profile for Chip Resistors

Table 1. Infrared soldering condition for Chip Resistors

| Temperature Condition | Exposure Time |
|---------------------------------------|-----------------------------|
| Average ramp-up rate (217°C to 260°C) | Less than 3°C/second |
| Between 150 and 200°C | Between 60-120 seconds |
| > 217°C | Between 60-150 seconds |
| Peak Temperature | 260°C +0/-5°C |
| Time within 245°C | Min. 30 seconds |
| Ramp-down rate (Peak to 217°C) | Less than 6°C/second |
| Time from 25°C to Peak | No greater than 480 seconds |

CATALOGUE NUMBERS

The resistors have a catalogue number starting with.

| WF06 | Q/R | xxxx | B | T | L |
|------------------|------------------|-----------------------------|------------------|-----------------------|-------------------------|
| Size code | Type code | Resistance code | Tolerance | Packaging code | Termination code |
| WF25: 2512 | Q: TCR = 50 ppm | R is first code followed by | T : ±0.01% | T : 7" Taped & Reeled | L : lead free |
| WF20: 2010 | R: TCR = 25 ppm | 3 significant digits. | U: ±0.02% | A : 7" Reel 15k pcs | |
| WF10: 1210 | High Power | 100Ω =1000 | A : ±0.05% | | |
| WF12: 1206 | | 37.4KΩ =3742 | B : ±0.10% | | |
| WF08: 0805 | | | C : ±0.25% | | |
| WF06: 0603 | | | D : ±0.50% | | |
| WF04: 0402 | | | F : ±1.00% | | |
| WF02: 0201 | | | | | |

1. Reeled tape packaging: 8mm width paper taping.

5,000pcs/reel for WF10, WF12, WF08, WF06

10,000pcs/reel for WF04

15,000pcs/reel for WF02

2. Reeled tape packaging: 12mm width paper taping

4,000pcs/reel for WF25, WF20



TEST AND REQUIREMENTS(JIS C 5201-1 : 1998)

| TEST | PROCEDURE | REQUIREMENT |
|--------------------------------------------------------------------|-------------------------------------------------------------------------------------------------------------------------------------------------------------------------------------------------------------------------------------------------------------------------------------------------------------------------|------------------------------------------------------|
| | | Resistor |
| DC resistance Clause 4.5 | DC resistance values measured | Within the specified tolerance |
| Temperature Coefficient of Resistance(T.C.R) Clause 4.8 | Natural resistance change per change in degree centigrade. $\frac{R_2 - R_1}{R_1(t_2 - t_1)} \times 10^6 \text{ (ppm/}^\circ\text{C)}$ R ₁ : Resistance at reference temperature R ₂ : Resistance at test temperature t ₁ : 20°C±5°C-1°C t ₂ : 125°C±5°C-1°C | Refer to “ QUICK REFERENCE DATA “ |
| Short time overload (S.T.O.L) Clause 4.13 | Permanent resistance change after a 5second application of a voltage 2.5 times RCWV or the maximum overload voltage specified in the above list, whichever is less. | ΔR/R max. ±(0.2%+0.05Ω) |
| Resistance to soldering heat(R.S.H) IEC 60068-2- 58:2004 | Un-mounted chips completely immersed for 10±1second in a SAC solder bath at 260°C±5°C | no visible damage Δ R/R max. ±(0.25%+0.05Ω) |
| Solderability IEC 60068-2- 58:2004 | Un-mounted chips completely immersed for 2±0.5 second in a SAC solder bath at 235°C±5°C | good tinning (>95% covered) no visible damage |
| Temperature cycling Clause 4.19 | 30 minutes at -55°C±3°C, 2~3 minutes at 20°C±5°C-1°C, 30 minutes at +155°C±3°C, 2~3 minutes at 20°C±5°C-1°C, total 5 continuous cycles | no visible damage ΔR/R max. ±(0.5%+0.05Ω) |
| Load Life (Endurance) Clause 4.25 | 70±2°C, 1000 hours, loaded with RCWV or Vmax,1.5 hours on and 0.5 hours off | ΔR/R max. ±(0.5%+0.05Ω) |
| Humidity Clause 4.24 | 1000 hours, at rated continuous working voltage in humidity chamber controller at 40°C±2°C and 90~95% relative humidity, 1.5hours on and 0.5 hours off | ΔR/R max. ±(0.5%+0.05Ω) |
| Bending strength Clause 4.33 | Resistors mounted on a 90mm glass epoxy resin PCB(FR4); bending : 3 mm, once for 10 seconds. | ΔR/R max. ±(0.1%+0.05Ω) |
| Adhesion Clause 4.32 | Pressurizing force: 5N, Test time: 10±1sec. | No remarkable damage or removal of the terminations. |

PACKAGING

Paper Tape specifications (unit :mm)

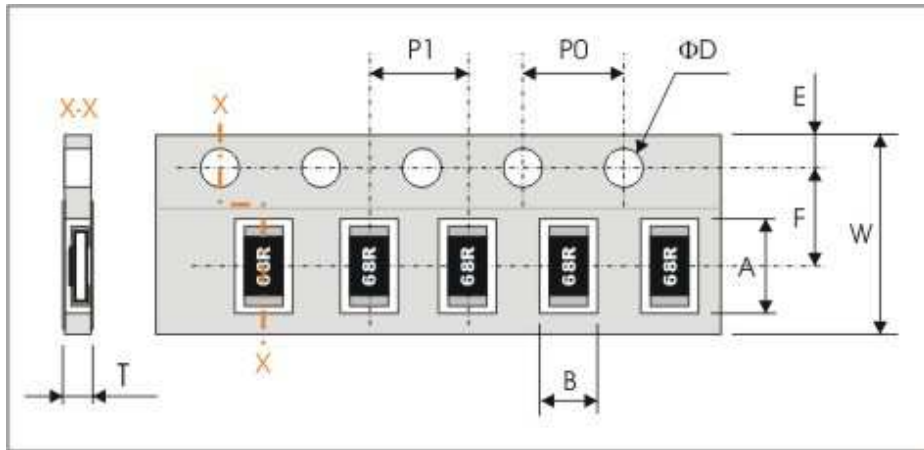

| Series No. | Tape | A | B | W | F | E |
|------------|---------|-----------|-----------|------------|-----------|-----------|
| WF25 | Plastic | 6.90±0.20 | 3.60±0.20 | 12.00±0.30 | 5.50±0.10 | 1.75±0.10 |
| WF20 | Plastic | 5.50±0.20 | 2.80±0.20 | 12.00±0.30 | 5.50±0.10 | 1.75±0.10 |
| WF10 | Paper | 3.60±0.20 | 3.00±0.20 | 8.00±0.30 | 3.50±0.20 | 1.75±0.10 |
| WF12 | Paper | 3.60±0.20 | 2.00±0.20 | 8.00±0.30 | 3.50±0.20 | 1.75±0.10 |
| WF08 | Paper | 2.40±0.20 | 1.65±0.20 | 8.00±0.30 | 3.50±0.20 | 1.75±0.10 |
| WF06 | Paper | 1.90±0.20 | 1.10±0.20 | 8.00±0.30 | 3.50±0.20 | 1.75±0.10 |
| WF04 | Paper | 1.20±0.10 | 0.70±0.10 | 8.00±0.30 | 3.50±0.05 | 1.75±0.10 |
| WF02 | Paper | 0.67±0.05 | 0.37±0.05 | 8.00±0.30 | 3.50±0.05 | 1.75±0.10 |

| Series No. | P1 | P0 | ΦD | T |
|------------|-----------|-----------|---------------------------------------|-----------|
| WF25 | 4.00±0.10 | 4.00±0.10 | Φ1.50 ^{+0.1} _{-0.0} | Max 1.2 |
| WF20 | 4.00±0.10 | 4.00±0.10 | Φ1.50 ^{+0.1} _{-0.0} | Max 1.2 |
| WF10 | 4.00±0.10 | 4.00±0.10 | Φ1.50 ^{+0.1} _{-0.0} | Max. 1.0 |
| WF12 | 4.00±0.10 | 4.00±0.10 | Φ1.50 ^{+0.1} _{-0.0} | Max. 1.0 |
| WF08 | 4.00±0.10 | 4.00±0.10 | Φ1.50 ^{+0.1} _{-0.0} | Max. 1.0 |
| WF06 | 4.00±0.10 | 4.00±0.10 | Φ1.50 ^{+0.1} _{-0.0} | 0.65±0.05 |
| WF04 | 2.00±0.10 | 4.00±0.10 | Φ1.50 ^{+0.1} _{-0.0} | 0.40±0.05 |
| WF02 | 2.00±0.05 | 4.00±0.05 | Φ1.50 ^{+0.1} _{-0.0} | 0.45±0.05 |

Reel dimensions

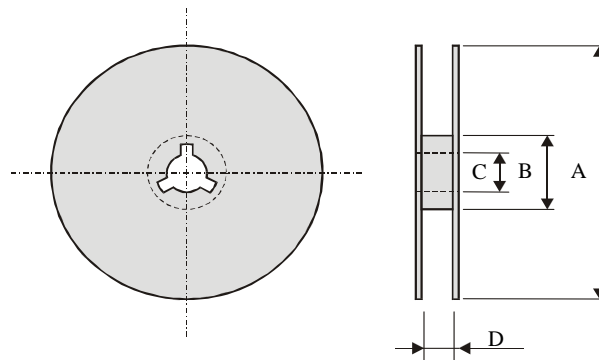

WF25 , WF20

| Symbol | A | B | C | D |
|-------------|----------------------|---------------------|----------------|----------------|
| (unit : mm) | $\Phi 178.0 \pm 2.0$ | $\Phi 60.0 \pm 1.0$ | 13.0 ± 0.2 | 14.0 ± 0.5 |

WF12 , WF10 , WF08 , WF06 , WF04

| Symbol | A | B | C | D |
|-------------|----------------------|---------------------|----------------|---------------|
| (unit : mm) | $\Phi 178.0 \pm 2.0$ | $\Phi 60.0 \pm 1.0$ | 13.0 ± 0.2 | 9.0 ± 0.5 |

WF02

| Symbol | A | B | C | D |
|-------------|--------------------------|-------------------------|----------------|------------------------|
| (unit : mm) | $\Phi 180^{+0.0}_{-1.5}$ | $\Phi 60^{+0.0}_{-1.5}$ | 13.0 ± 0.2 | $\Phi 9^{+1.0}_{-0.0}$ |

Taping quantity

- Chip resistors 4,000 pcs per reel (WF25,WF20)
- Chip resistors 5,000 pcs per reel (WF10,WF12,WF08,WF06)
- Chip resistors 10,000 pcs per reel (WF04)
- Chip resistors 15,000 pcs per reel (WF02)

X-ON Electronics

Largest Supplier of Electrical and Electronic Components

Click to view similar products for [Thick Film Resistors - SMD category](#):

Click to view products by [Walsin manufacturer](#):

Other Similar products are found below :

[CR-05FL7--150R](#) [CR-05FL7--19K6](#) [CR-05FL7--243R](#) [CR-05FL7--40K2](#) [CR-05FL7--698K](#) [CR-12FP4--324R](#) [CR-12JP4--680R](#)

[M55342K06B1E78RS3](#) [M55342K06B6E19RWL](#) [M55342K06B6E81RS3](#) [M55342M05B200DRWB](#) [M55342M06B4K70MS3](#) [MC0603-511-](#)

[JTW](#) [742C083750JTR](#) [MCR01MZPF1202](#) [MCR01MZPF1601](#) [MCR01MZPF1800](#) [MCR01MZPF6201](#) [MCR01MZPF9102](#) [MCR01MZPJ113](#)

[MCR01MZPJ121](#) [MCR01MZPJ125](#) [MCR01MZPJ751](#) [MCR03EZHJ103](#) [MCR03EZPFX2004](#) [MCR03EZPJ270](#) [MCR03EZPJ821](#)

[MCR10EZPF1102](#) [MCR18EZPJ330](#) [RC0603F1473CS](#) [RC0603F150CS](#) [RC1005F1152CS](#) [RC1005F1182CS](#) [RC1005F1372CS](#)

[RC1005F183CS](#) [RC1005F1911CS](#) [RC1005F1912CS](#) [RC1005F203CS](#) [RC1005F2052CS](#) [RC1005F241CS](#) [RC1005F2431CS](#)

[RC1005F3011CS](#) [RC1005F303CS](#) [RC1005F4321CS](#) [RC1005F4642CS](#) [RC1005F471CS](#) [RC1005F4751CS](#) [RC1005F5621CS](#)

[RC1005F6041CS](#) [RC1005J106CS](#)