

APPROVAL SHEET

WF12G, WF08G, WF06G, WF04G

±1%, ±5%, 11MΩ~100MΩ

High ohm chip resistors

Size 1206, 0805, 0603, 0402

*Contents in this sheet are subject to change without prior notice

FEATURE

1. Small size and light weight
2. High reliability and stability
3. Reduced size of final equipment
4. Higher component and equipment reliability
5. RoHS compliant and lead free products.

APPLICATION

- Power supply
- PDA
- Digital meter
- Computer
- Palmtop computers

DESCRIPTION

The resistors are constructed in a high grade ceramic body (aluminum oxide). Internal metal electrodes are added at each end and connected by a resistive paste that is applied to the top surface of the substrate. The composition of the paste is adjusted to give the approximate resistance required and the value is trimmed to nominated value within tolerance which controlled by laser trimming of this resistive layer.

The resistive layer is covered with a protective coat. Finally, the two external end terminations are added. For ease of soldering the outer layer of these end terminations is Tin (lead free) alloy.

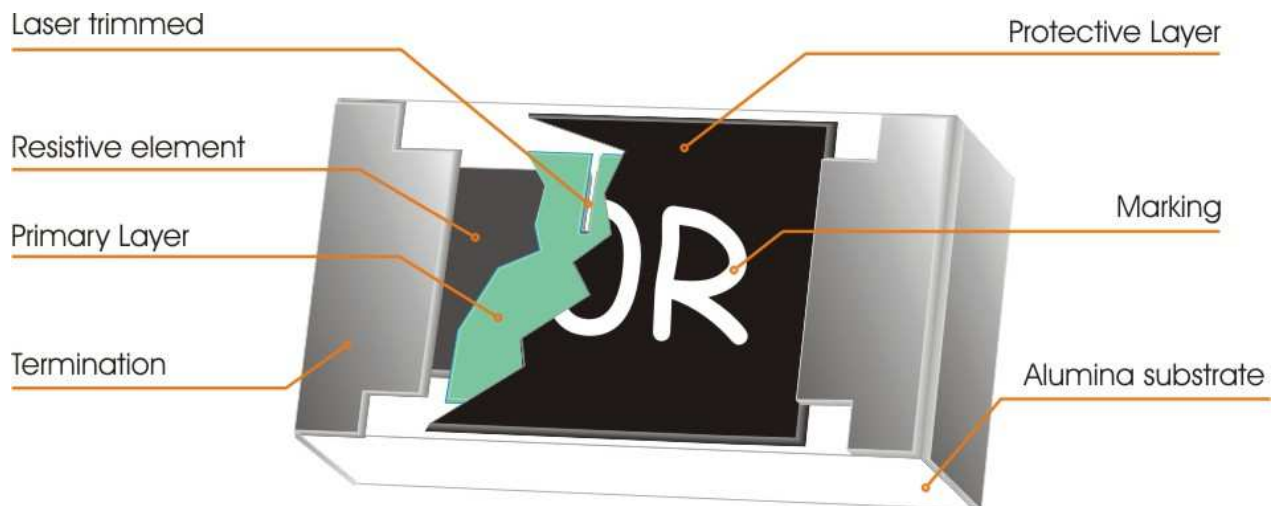

Fig 1. Construction of Chip-R

QUICK REFERENCE DATA

Item	General Specification			
Series No.	WF12G	WF08G	WF06G	WF04G
Size code	1206 (3216)	0805 (2125)	0603 (1608)	0402 (1005)
Resistance Tolerance	±1%, ±5%			
Resistance Range	10MΩ < R ≤ 100MΩ			10MΩ < R ≤ 30MΩ (E24 series)
TCR (ppm/°C)	≤ ± 200 ppm/°C			≤ ± 300 ppm/°C
Max. dissipation at T _{amb} =70°C	1/4 W	1/8 W	1/10 W	1/16W
Max. Operation Voltage (DC or RMS)	200V	150V	50V	50V
Climatic category (IEC 60068)	55/155/56			

Note :

- This is the maximum voltage that may be continuously supplied to the resistor element, see "IEC publication 60115-8"
- Max. Operation Voltage : So called RCWV (Rated Continuous Working Voltage) is determined by

$$RCWV = \sqrt{\text{Rated Power} \times \text{Resistance Value}} \text{ or Max. RCWV listed above, whichever is lower.}$$

DIMENSIONS(unit : mm)

series	WF12G	WF08G	WF06G	WF04G
L	3.10 ± 0.15	2.00 ± 0.10	1.60 ± 0.10	1.00 ± 0.05
W	1.60 ± 0.15	1.25 ± 0.10	0.80 ± 0.10	0.50 ± 0.05
Tt	0.50 ± 0.25	0.40 ± 0.20	0.30 ± 0.10	0.20 ± 0.10
Tb	0.50 ± 0.25	0.40 ± 0.20	0.30 ± 0.15	0.25 ± 0.10
T	0.55 ± 0.10	0.50 ± 0.15	0.45 ± 0.15	0.35 ± 0.05

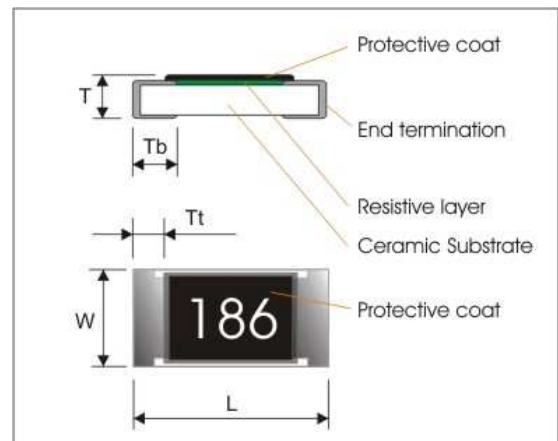
**MARKING****3-digits marking**

Each resistor is marked with a three digits code on the protective coating to designate the nominal resistance value.

Example

$$306 = 30 \text{ M}\Omega$$

$$186 = 18 \text{ M}\Omega$$

FUNCTIONAL DESCRIPTION

Product characterization

Standard values of nominal resistance are taken from the E96 & E24 series for resistors with a tolerance of $\pm 1\%$, $\pm 5\%$. The values of the E24/E96 series are in accordance with "IEC publication 60063".

Derating

The power that the resistor can dissipate depends on the operating temperature; see Fig.2

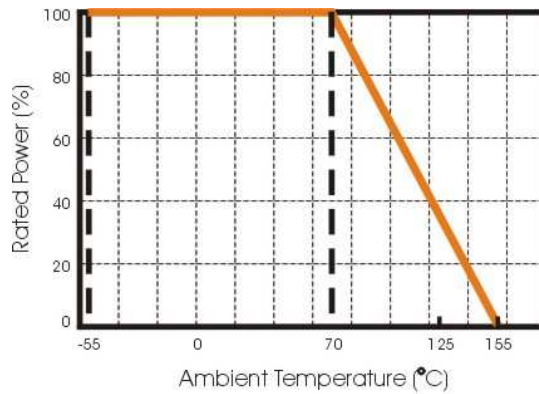

Figure 2. Maximum dissipation in percentage of rated power
As a function of the ambient temperature

SOLDERING CONDITION

The robust construction of chip resistors allows them to be completely immersed in a solder bath of 260°C for 10 seconds. Therefore, it is possible to mount Surface Mount Resistors on one side of a PCB and other discrete components on the reverse (mixed PCBs).

Surface Mount Resistors are tested for solderability at 235°C during 2 seconds. The test condition for no leaching is 260°C for 30 seconds. Typical examples of soldering processes that provide reliable joints without any damage are given in below. WF04G is not guaranteed with wave soldering process due to its 0402 size.

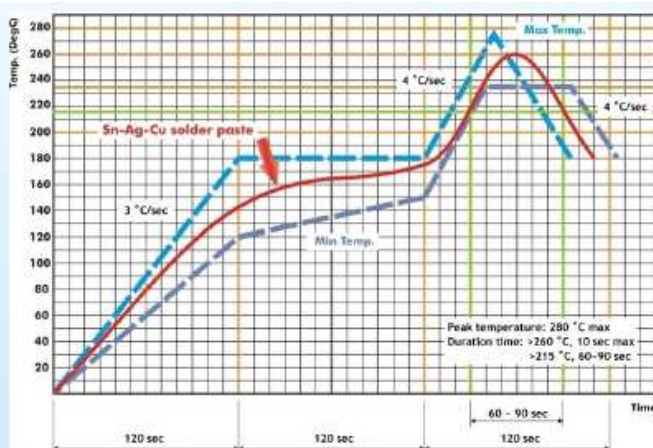

Fig. 1 Recommended IR reflow soldering profile for SMT process with SnAgCu series solder paste.

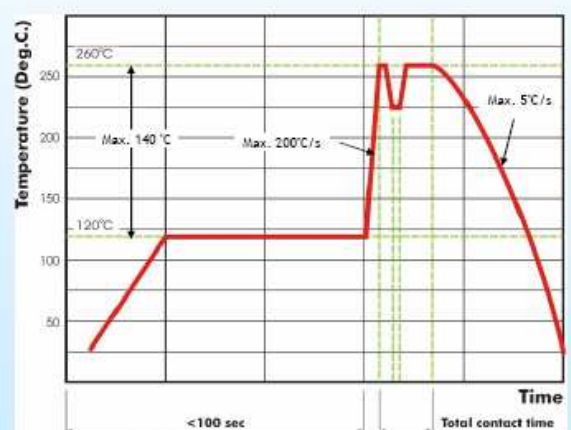

Fig. 2 Recommended wave soldering profile for SMT process with SnAgCu series solder.

CATALOGUE NUMBERS

The resistors have a catalogue number starting with :

WF06	G	226_	J	T	L
Size code	Type code	Resistance code	Tolerance	Packaging code	Termination code
WF12 : 1206	G : High ohmic >10MΩ	5% E24: 2 significant digits followed by no. of zeros and a blank	J : ±5%	T : 7" Reeled taping	L = Sn base (lead free)
WF08 : 0805	1206 size=0.25W	11MΩ =116_	F : ±1%	B : Bulk	
WF06 : 0603	0805 size=0.125W	22MΩ =226_			
WF04 : 0402	0603 size=0.10W	30MΩ =306_			
		("_" means a blank)			
		1%, E24+E96: 3 significant digits followed by no. of zeros			
		100Ω =1000			
		37.4KΩ =3742			

1. Reeled tape packaging : 8mm width paper taping 5000pcs per 7" reel for 1206, 0805, 0603 (10,000pcs for 0402)
2. Bulk packaging : 5000pcs per polybag

TEST AND REQUIREMENTS(JIS C 5201-1 : 1998)

TEST	PROCEDURE	REQUIREMENT
Temperature Coefficient of Resistance (T.C.R) Clause 4.8	Natural resistance change per change in degree centigrade. $\frac{R_2 - R_1}{R_1(t_2 - t_1)} \times 10^6 \text{ (ppm/}^\circ\text{C)}$ R ₁ : Resistance at reference temperature R ₂ : Resistance at test temperature t ₁ : 20°C±5°C-1°C t ₂ : Test temperature.	Refer to quick reference data for T.C.R specification.
Short time overload (S.T.O.L) Clause 4.13	Permanent resistance change after a 5 second application of a voltage 2.5xU _R or max. Overload voltage, whichever is less.	No visible damage. $\Delta R/R \text{ max. J: } \leq \pm(2\%+0.1\Omega)$ $F: \leq \pm(1\%+0.05\Omega)$
Solderability Clause 4.17	Un-mounted chips completely immersed for 2±0.5 second in a SAC solder bath at 235°C±5°C.	good tinning (>95% covered) no visible damage
Resistance to soldering heat(R.S.H) Clause 4.18	Un-mounted chips completely immersed for 10±1second in a SAC solder bath at 260°C±5°C	No visible damage. $\Delta R/R \text{ max. J: } \leq \pm(1\%+0.1\Omega)$ $F: \leq \pm(0.5\%+0.05\Omega)$

TEST	PROCEDURE	REQUIREMENT
Temperature cycling Clause 4.19	1. 30 minutes at $-55^{\circ}\text{C}\pm 3^{\circ}\text{C}$, 2. 2~3 minutes at $20^{\circ}\text{C}\pm 5^{\circ}\text{C}-1^{\circ}\text{C}$, 3. 30 minutes at $+155^{\circ}\pm 3^{\circ}\text{C}$, 4. 2~3 minutes at $20^{\circ}\text{C}\pm 5^{\circ}\text{C}-1^{\circ}\text{C}$, Total 5 continuous cycles.	No visible damage. $\Delta R/R$ max. $J \leq \pm(1\%+0.1\Omega)$ $F \leq \pm(0.5\%+0.05\Omega)$
Load life (endurance) Clause 4.25	1000 +48/-0 hours, loaded with RCWV or Vmax in chamber controller $70\pm 2^{\circ}\text{C}$, 1.5 hours on and 0.5 hours off	No visible damage. $\Delta R/R$ max. $J \leq \pm(3\%+0.1\Omega)$ $F \leq \pm(1\%+0.05\Omega)$
Load life in Humidity Clause 4.24	1000 +48/-0 hours, loaded with RCWV or Vmax in humidity chamber controller at $40^{\circ}\text{C}\pm 2^{\circ}\text{C}$ and 90~95% relative humidity, 1.5hours on and 0.5 hours off	No visible damage. $\Delta R/R$ max. $J \leq \pm(3\%+0.1\Omega)$ $F \leq \pm(1\%+0.05\Omega)$
Bending strength Clause 4.33	Resistors mounted on a 90mm glass epoxy resin PCB(FR4); bending : 3 mm, once for 10 seconds	$\Delta R/R$ max. $\pm(1\%+0.10\Omega)$
Adhesion Clause 4.32	Pressurizing force: 5N, Test time: 10 ± 1 sec.	No remarkable damage or removal of the terminations.
Insulation Resistance Clause 4.6	Apply the maximum overload voltage (DC) for 1minute	$R \geq 10\text{G}\Omega$
Dielectric Withstand Voltage Clause 4.7	Apply the maximum overload voltage (AC) for 1 minute	No breakdown or flashover

PACKAGING

Paper Tape specifications (unit :mm)

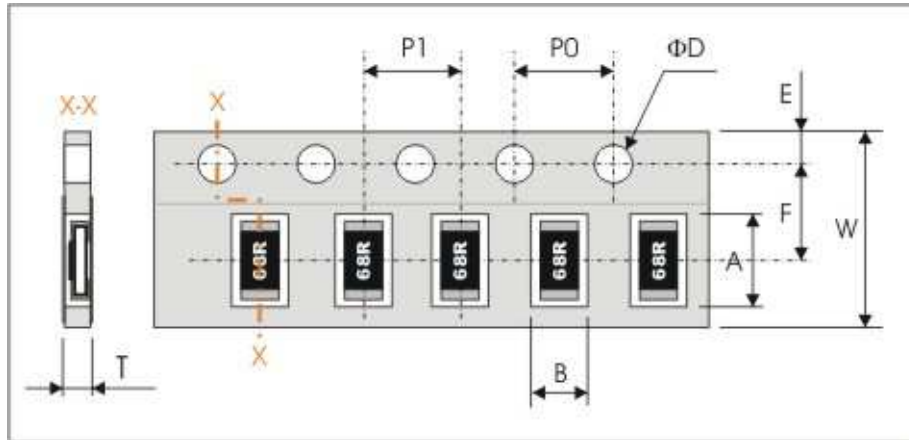

Series No.	A	B	W	F	E
WF12G	3.60±0.20	2.00±0.20	8.00±0.30	3.50±0.2	1.75±0.10
WF08G	2.40±0.20	1.65±0.20	8.00±0.30	3.50±0.2	1.75±0.10
WF06G	1.90±0.20	1.10±0.20	8.00±0.30	3.50±0.2	1.75±0.10
WF04G	1.20±0.10	0.70±0.10	8.00±0.30	3.50±0.2	1.75±0.10

Series No.	P1	P0	ΦD	T
WF12G	4.00±0.10	4.00±0.10	Φ1.50 ^{+0.1} _{-0.0}	Max. 1.0
WF08G	4.00±0.10	4.00±0.10		0.65±0.1
WF06G	4.00±0.10	4.00±0.10		0.40±0.05
WF04G	2.00±0.10	4.00±0.10		

Reel dimensions

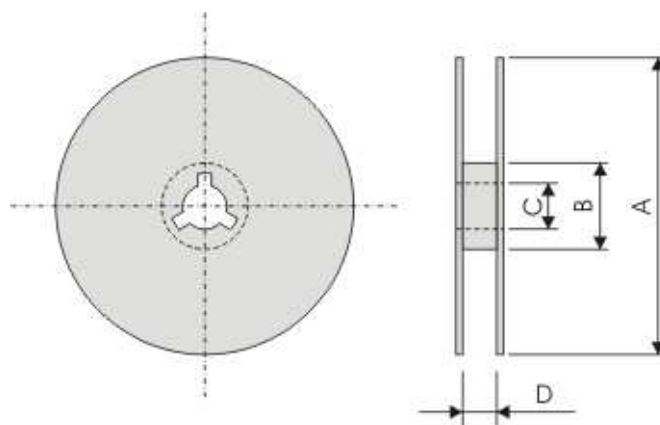

Symbol	A	B	C	D
(unit : mm)	Φ178.0±2.0	Φ60.0±1.0	13.0±0.2	9.0±0.5

Taping quantity

- Chip resistors 5,000 pcs/reel for 1206, 0805, 0603 (10,000 pcs/reel for 0402)

X-ON Electronics

Largest Supplier of Electrical and Electronic Components

Click to view similar products for [Thick Film Resistors](#) category:

Click to view products by [Walsin](#) manufacturer:

Other Similar products are found below :

[MCR03EZPFX3162](#) [MCR004YZPJ332](#) [201007J022KT4E](#) [201007F1653T4E](#) [201007F6652T4E](#) [0603WAF137KT5E](#) [RTT204702FTE](#)
[RTT203000FTE](#) [RTT2056R0FTE](#) [CR2010F470KE04Z](#) [RTT018451FTH](#) [RTT021802DTH](#) [0402WGF510LTCE](#) [0201WMJ0200TEE](#)
[TR0603B26K7P0550Z](#) [0201WMF5102TEE](#) [1210W2J047KT5E](#) [YLR12-2-4F-W](#) [HOT\(0.25x1.3\)-3.2-0R-I](#) [HOT\(0.4x1.5\)-5.2-0R-I](#)
[HoT\(0.45x1.5\)-8.2-0R-I](#) [0201WMF1103TEE](#) [0201WMF7152TEE](#) [1210W2J0124T5E](#) [201007J010LT4E](#) [201007J0360T4E](#) [201007J0430T4E](#)
[0805W8F931KT5E](#) [1206W4F5231T5E](#) [1210W2J0620T5E](#) [201007J0822T4E](#) [0201WMF1005TCE](#) [0201WMF1212TCE](#) [0201WMF1373TCE](#)
[0201WMF1400TCE](#) [0201WMF2000TEE](#) [0201WMF2001TCE](#) [0201WMF226JTCE](#) [0201WMF2672TCE](#) [0201WMF2803TCE](#)
[0201WMF357JTCE](#) [0201WMF3743TCE](#) [0201WMF430JTCE](#) [0201WMF4990TCE](#) [0201WMF5104TCE](#) [0201WMF510JTEE](#)
[0201WMF5110TCE](#) [0201WMF6652TEE](#) [0201WMF6812TCE](#) [0201WMF8200TCE](#)