

APPROVAL SHEET

WW12M, WW12N

±1%, ±5%, 1/2W, 1W

Ultra low ohm power chip resistors

Size 1206 (3216)

Metal Current Sensing Type

RoHS Exemption free and Total Lead Free

*Contents in this sheet are subject to change without prior notice.

FEATURE

1. Ultra low and stable TCR performance
2. High power rating and compact size
3. High reliability and stability
4. Reduced size of final equipment
5. RoHS compliant and Total Lead free product
6. Inductance below 1nH

APPLICATION

- Power supply
- PDA
- Digital meter
- Computer
- Automotives
- Battery charger
- DC-DC power converter

DESCRIPTION

The resistors are constructed in a high grade low resistive metal body. The resistive layer is covered with a protective coat and printed a resistance marking code over it. Finally, the two external end terminations are added. For ease of soldering the outer layer of these end terminations is a lead-free solder.

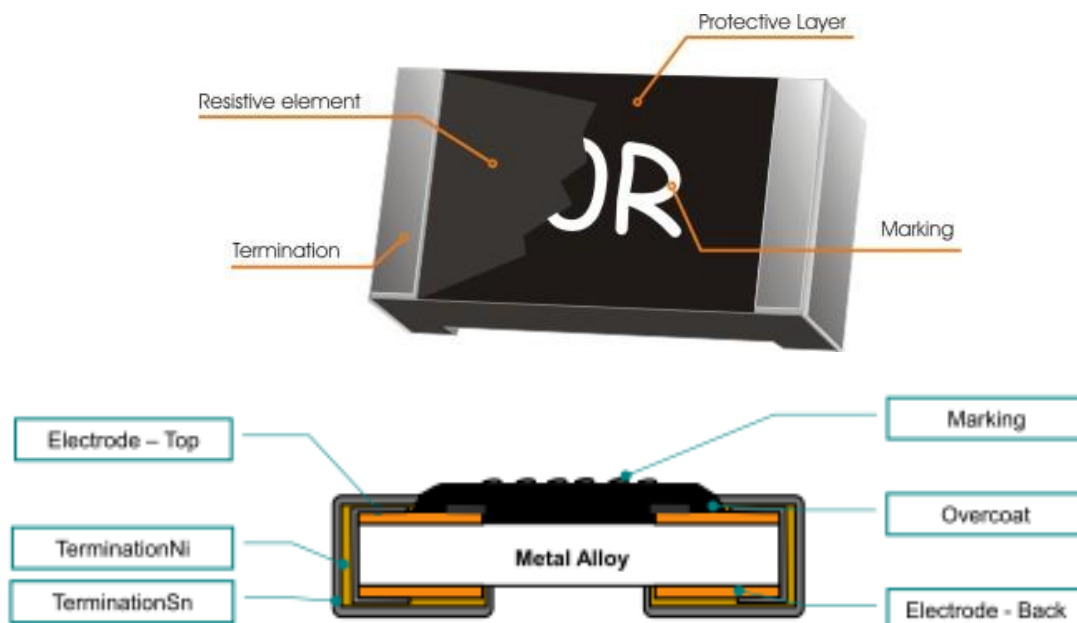

Fig 1. Construction of Chip-R

QUICK REFERENCE DATA

Item	General Specification	
	Series No.	WW12M
Size code	1206 (3216)	
Resistance Tolerance	±5%; ±1%	
Resistance Value	0.003Ω, 0.004Ω, 0.005Ω, 0.006Ω, 0.007Ω, 0.008Ω, 0.009Ω, 0.010Ω, 0.015Ω, 0.018Ω, 0.020Ω, 0.025Ω, 0.030Ω	
TCR (ppm/°C)	≤ 70 ppm/°C	
Max. dissipation at T _{amb} =70°C	1/2W	1 W
Max. Operation Voltage (DC or RMS)	200V	
Max. Overload Voltage (DC or RMS)	400V	
Climatic category (IEC 60068)	55/155/56	

Note :

- This is the maximum voltage that may be continuously supplied to the resistor element, see "IEC publication 60115-8"
- Max. Operation Voltage : So called RCWV (Rated Continuous Working Voltage) is determined by

$$RCWV = \sqrt{\text{Rated Power} \times \text{Resistance Value}}$$
or Max. RCWV listed above, whichever is lower.
- 1W loading with total solder-pad size of 300 mm²

MECHANICAL DATA

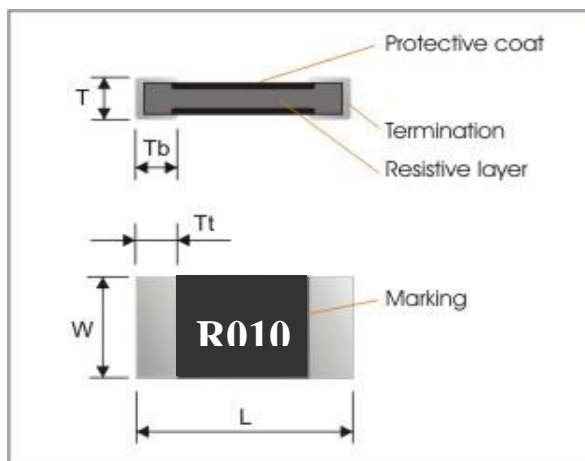

Symbol	Dimensions (mm)
L	3.10±0.20
W	1.60±0.20
T	0.60±0.25
Tt	0.60±0.20
Tb	0.60±0.20

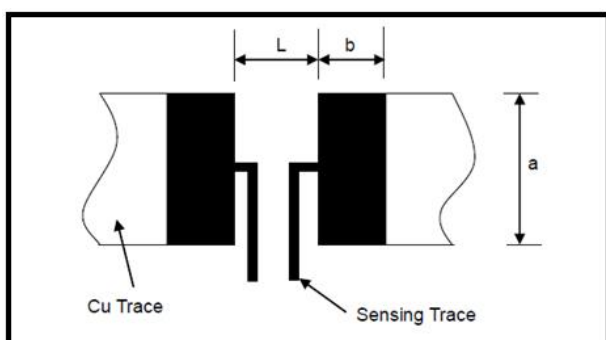

Symbol	Dimensions (mm)
a	1.80±0.20
b	1.30±0.20
L	2.10±0.20

MARKING

Each resistor is marked with a four-digit code on the protective coating to designate the nominal resistance value.



R020 = 20mΩ

FUNCTIONAL DESCRIPTION

Derating curve

The power that the resistor can dissipate depends on the operating temperature; see Fig.2

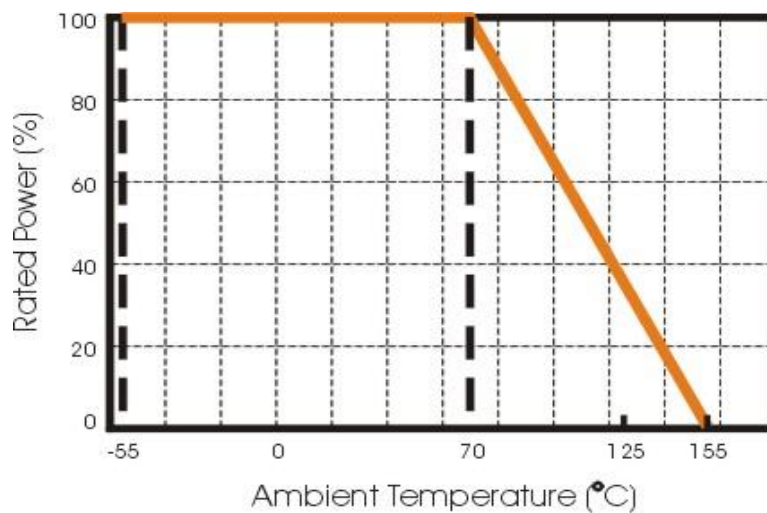

Fig.2 Maximum dissipation in percentage of rated power
As a function of the ambient temperature

MOUNTING

Due to their rectangular shapes and small tolerances, Surface Mountable Resistors are suitable for handling by automatic placement systems.

Chip placement can be on ceramic substrates and printed-circuit boards (PCBs).

Electrical connection to the circuit is by individual soldering condition.

The end terminations guarantee a reliable contact.

SOLDERING CONDITION

The robust construction of chip resistors allows them to be completely immersed in a solder bath of 260°C for 10 seconds. Therefore, it is possible to mount Surface Mount Resistors on one side of a PCB and other discrete components on the reverse (mixed PCBs).

Surface Mount Resistors are tested for solderability at 235°C during 2 seconds. The test condition for no leaching is 260°C for 30 seconds. Typical examples of soldering processes that provide reliable joints without any damage are given in Fig 3.

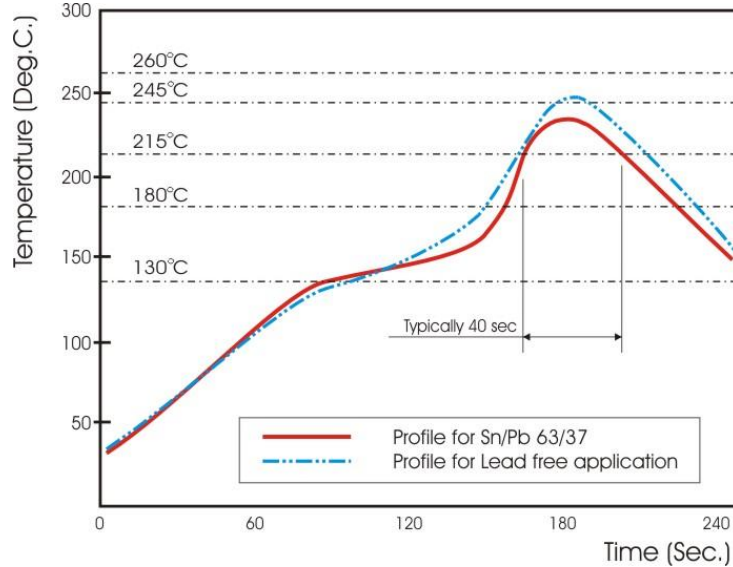

Fig 3. Infrared soldering profile for Chip Resistors WW12

CATALOGUE NUMBERS

The resistors have a catalogue number starting with .

WW12	N	R010	F	T	L
Size code WW12 : 1206	Type code M : 1/2W N : 1W Sensing type	Resistance code R is first digit followed by 3 significant digits. 0.010Ω = R010	Tolerance J : ±5% F : ±1%	Packaging code T : 7" reeled in tape, 4,000pcs	Termination code L = Sn base (lead free)

Chip resistors 4,000 pcs per Paper Tape reel.

TEST AND REQUIREMENTS (JIS C 5201-1 : 1998)

Essentially all tests are carried out according to the schedule of IEC publication 115-8, category **LCT/UCT/56**(rated temperature range : Lower Category Temperature, Upper Category Temperature; damp heat, long term, 56 days). The testing also meets the requirements specified by EIA, EIAJ and JIS.

The tests are carried out in accordance with IEC publication 68, "Recommended basic climatic and mechanical robustness testing procedure for electronic components" and under standard atmospheric conditions according to IEC 60068-1, subclause 5.3. Unless otherwise specified, the following value supplied :

Temperature: 15°C to 35°C.

Relative humidity: 45% to 75%.

Air pressure: 86kPa to 106 kPa (860 mbar to 1060 mbar).

All soldering tests are performed with mildly activated flux.

TEST	PROCEDURE	REQUIREMENT
Temperature Coefficient of Resistance(T.C.R) Clause 4.8	Natural resistance change per change in degree centigrade. $\frac{R_2 - R_1}{R_1(t_2 - t_1)} \times 10^6 \text{ (ppm/}^\circ\text{C)}$ $t_1 : 20^\circ\text{C}+5^\circ\text{C}-1^\circ\text{C}$ R_1 : Resistance at reference temperature R_2 : Resistance at test temperature	Refer to "QUICK REFERENCE DATA"
Short time overload (S.T.O.L) Clause 4.13	Permanent resistance change after a 5 second application of 5 times rated power specified in the above list,	no visible damage $\Delta R/R$ max. $\pm(1\%+0.0001\Omega)$
Resistance to soldering heat(R.S.H) Clause 4.18	Un-mounted chips completely immersed for 10 ± 1 second in a SAC solder bath at $260^\circ\text{C} \pm 5^\circ\text{C}$	no visible damage $\Delta R/R$ max. $\pm(1\%+0.0001\Omega)$
Solderability Clause 4.17	Un-mounted chips completely immersed for 2 ± 0.5 second in a SAC solder bath at $235^\circ\text{C} \pm 5^\circ\text{C}$	good tinning (>95% covered) no visible damage
Temperature cycling Clause 4.19	30 minutes at $-55^\circ\text{C} \pm 3^\circ\text{C}$, 2~3 minutes at $20^\circ\text{C}+5^\circ\text{C}-1^\circ\text{C}$, 30 minutes at $+155^\circ\text{C} \pm 3^\circ\text{C}$, 2~3 minutes at $20^\circ\text{C}+5^\circ\text{C}-1^\circ\text{C}$, total 5 continuous cycles	no visible damage $\Delta R/R$ max. $\pm(1\%+0.0001\Omega)$
Load life (endurance) Clause 4.25	$70\pm 2^\circ\text{C}$, 1000 hours, loaded with RCWV or V_{max} , 1.5 hours on and 0.5 hours off	no visible damage $\Delta R/R$ max. $\pm(2\%+0.0001\Omega)$
Load life in Humidity Clause 4.24	1000 hours, at rated continuous working voltage in humidity chamber controller at $40^\circ\text{C} \pm 2^\circ\text{C}$ and 90~95% relative humidity, 1.5hours on and 0.5 hours off	no visible damage $\Delta R/R$ max. $\pm(2\%+0.0001\Omega)$
Adhesion Clause 4.32	Pressurizing force: 5N, Test time: 10 ± 1 sec.	No remarkable damage or removal of the terminations

PACKAGING

Paper Tape specifications (unit :mm)

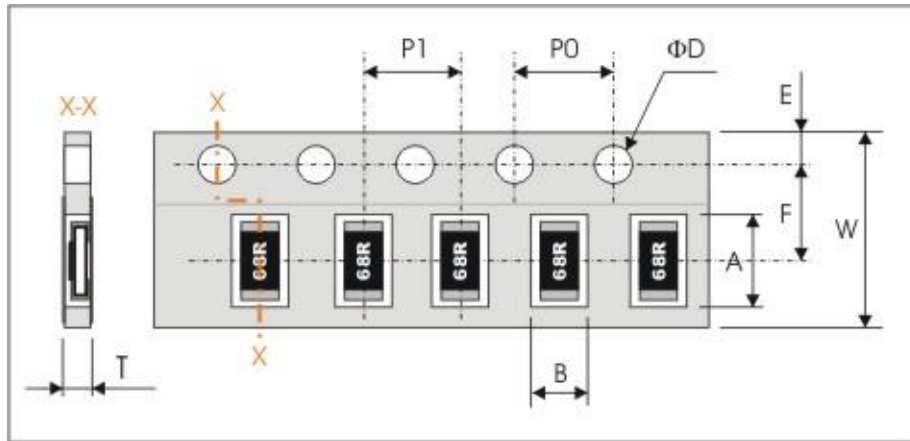

Series No.	A	B	W	F	E
WW12M, WW12N	3.60±0.20	2.00±0.20	8.00±0.30	3.50±0.05	1.75±0.10

Series No.	P1	P0	ΦD	T
WW12M, WW12N	4.00±0.10	4.00±0.10	Φ1.50 ^{+0.1} _{-0.0}	Max. 1.2

Reel dimensions

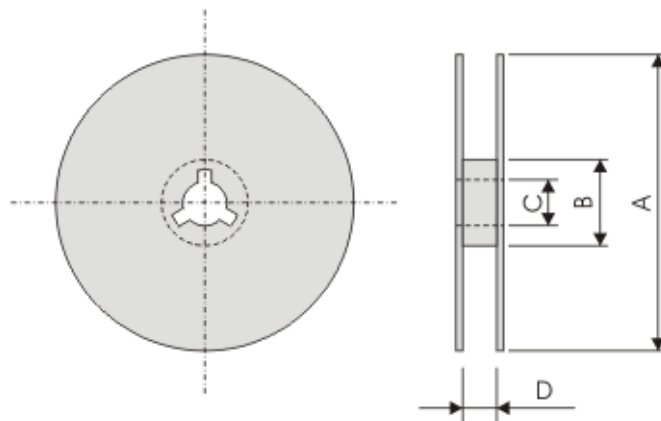

Symbol	A	B	C	D
(unit : mm)	Φ178.0±2.0	Φ60.0±1.0	13.0±0.2	9.0±0.5

Taping qty: 4000pcs per reel

X-ON Electronics

Largest Supplier of Electrical and Electronic Components

Click to view similar products for [Thick Film Resistors - SMD category](#):

Click to view products by [Walsin manufacturer](#):

Other Similar products are found below :

[CR-05FL7--150R](#) [CR-05FL7--19K6](#) [CR-05FL7--243R](#) [CR-05FL7--40K2](#) [CR-05FL7--698K](#) [CR-12FP4--324R](#) [CR-12JP4--680R](#)
[M55342K06B1E78RS3](#) [M55342K06B6E19RWL](#) [M55342K06B6E81RS3](#) [M55342M05B200DRWB](#) [M55342M06B4K70MS3](#) [MC0603-511-](#)
[JTW](#) [742C083750JTR](#) [MCR01MZPF1202](#) [MCR01MZPF1601](#) [MCR01MZPF1800](#) [MCR01MZPF6201](#) [MCR01MZPF9102](#) [MCR01MZPJ113](#)
[MCR01MZPJ121](#) [MCR01MZPJ125](#) [MCR01MZPJ751](#) [MCR03EZHJ103](#) [MCR03EZPFX2004](#) [MCR03EZPJ270](#) [MCR03EZPJ821](#)
[MCR10EZPF1102](#) [MCR18EZPJ330](#) [RC0603F1473CS](#) [RC0603F150CS](#) [RC1005F1152CS](#) [RC1005F1182CS](#) [RC1005F1372CS](#)
[RC1005F183CS](#) [RC1005F1911CS](#) [RC1005F1912CS](#) [RC1005F203CS](#) [RC1005F2052CS](#) [RC1005F241CS](#) [RC1005F2431CS](#)
[RC1005F3011CS](#) [RC1005F303CS](#) [RC1005F4321CS](#) [RC1005F4642CS](#) [RC1005F471CS](#) [RC1005F4751CS](#) [RC1005F5621CS](#)
[RC1005F6041CS](#) [RC1005J106CS](#)