

PRODUCT SPECIFICATION

**PRODUCT: CERAMIC DISC CAPACITOR
SAFETY RECOGNIZED**

TYPE: AH SERIES

CUSTOMER: _____

DOC. NO.: POE-D10-00-E-22

APPROVED BY CUSTOMER

VENDOR :

- WALSIN TECHNOLOGY CORPORATION**
566-1, KAO SHI ROAD, YANG-MEI
TAO-YUAN, TAIWAN
- PAN OVERSEAS (GUANGZHOU) ELECTRONIC CO.,LTD.**
NO.277,HONG MING ROAD,EASTERN SECTION,
GUANG ZHOU ECONOMIC AND TECHNOLOGY
DEVELOPMENT ZONE,CHINA
- DONGGUAN WALSIN TECHNOLOGY ELECTRONICS CO., LTD.**
NO.638, MEI JING WEST ROAD,XINIUPO,ADMINISTRATIVE
ZONE,DALANGTOWN,DONGGUAN CITY, GUANGDONG PROVINCE

MANUFACTURE SITE :

- PAN OVERSEAS (GUANGZHOU) ELECTRONIC CO.,LTD.**
NO.277,HONG MING ROAD,EASTERN SECTION,
GUANG ZHOU ECONOMIC AND TECHNOLOGY
DEVELOPMENT ZONE,CHINA



**SAFETY STANDARDS REGULATED, REINFORCED
INSULATION TYPE, AH SERIES**

POE-D10-00-E-22

Ver: 22

Page: 2 / 19

Record of change

Date	Version	Description	page
2008.6.3	1	1. D22-00-E-01(before) → POE-D10-00-E-01(1st edition)	
2008.8.22	2	1. Complete lead code 2. Add last SAP code “ H” for halogen and Pb free , epoxy resin..	21 3
2008.12.12	3	1. Complete the 13th to 17th codes of SAP P/N. 2. Page layout adjustment.	4-5
2009.7.8	4	1. 1 Change PSA & POE logo to Walsin & POE logo. 2. Complete Marking statement. 3. Revised standard NO. of SEV, SEMKO, FIMKO, NEMKO, DEMKO and KEMA. 4. Revised recognized NO. of FIMKO, NEMKO, DEMKO and KEMA.	10 12
2009.9.14	5	1. H0: 18.0+2.0/-1.5 revised to 18.0+2.0/-0 2. “Protrusion length”: “+0.5to-1.0” revised to “2.0max (Or the end of lead wire may be inside the tape.)” 3. 3. Add “250V~” under the “UL” mark according to the product’s marking.	9 9 10
2009.12.24	6	1. Marking 2. Correct X1 of recognized No by KTL. 3. Revised the Figure of impulse voltage test(Item 7.3.14) according to the standard IEC 60384-14 ed.3 4. Add “1AH” code for Y1:400V marking type.	10 11 14 4
2011.1.11	7	1. Review SAP P/N about diameter code: YU*AH561K100*→YU*AH561K080* 2. Delete “AT” taping type. 3. Add test item “Temperature Cycle ” . 4. Add item 10 “Drawing of internal structure and material list”	6 4,5,8,9 14 19
2011.5.12	8	1. Review the safety standards approval and recognized no. 2. Delete “old P/N” 3. Add the special marking for P/N:YP*AH102K100	10 5~6 9
2012.1.30	9	1. Review the approval rated voltage of UL and the marking.	8~9
2012/4/6	10	1. In order to improve the traceability of the product, change the date code on capacitor body, new date code can trace back to production “Lot No.”	8
2013/5/13	11	1. Review the Lead diameter ϕ from 0.60 +0.1/-0.05mm to 0.55+/-0.05mm 2. Add“3.1 Norminal parts&3.2 special for surge parts” for “3. Part numbering/T.C/Capacitance/ Tolerance/Diameter” 3. In order the customer to know the round time of manufacture, change the date code on capacitor body, new date code can know the month of manufacture. 4. Delete “No marked with “ _ ” stand for Pb free” 5. Delete “When the TCC is Y5V(YV), there is a “F” between the “AH” and capacitance code.” 6. Review the Solderability time from 2 ±0.5s to 5±0.5s	5,6,7 6 8 8 8 11
2013/10/16	12	1. Review the “Manufactured Date” to “Products ID” on the marking page 2. Delete “The marking can be printed on either one side or two side of coating body. “and add “for SAP part number 10-11 digits ≤ ‘07’ products” to two sides and “for SAP part number 11-12 digits ≥ ‘08 products” to one side.	8 8
2014/11/5	13	1. Review the size of SL*AH820J*** from 080 to be 090. 2. Review the terminal position of the lead wire. 3. Review the product of ID, add the code “D” for the products of Dongguan Walsin Technology Electronics Co., Ltd. 4. Review the Operating Temperature Range, from “-25 to +125°C” to be “-40 to +125°C”. 5. Review the minimum packing quantity of taping code AM. 6. Review the low temperature range from -25°C to -40°C for temperature cycle test.	6 7 8 11 15 13
2016/1/27	14	1. Review the Available lead code of Lead Configuration 2. Add the SAP P/N :YU*AH681M*. 3. Revised standard NO. of VDE, SEV, SEMKO, FIMKO, NEMKO and DEMKO.	5 6 9
2016/5/3	15	1. Delete 6 Pf~10 Pf for P/N CH*AH***D06 * *, 12 Pf for P/N CH*AH120J06 * * and 15 Pf~27 Pf for P/N CH*AH***J07 * * . 2. Add 10 Pf&12 Pf for P/N SL*AH***J06 * *	6 6

Record of change (continue)

Date	Version	Description	page
2016/11/3	16	1. Delete "CH" series.	4,6,10~13,18
2017/2/16	17	1. Add "C" code Pitch 12.5mm.	4,5
2017/3/10	18	1. Revise CQC Standard No.	10
2018/8/11	19	1. Revised standard NO. of VDE, SEV, SEMKO, FIMKO, NEMKO and DEMKO.	10
2019/2/25	20	1. Delete "3.2 Special design parts" for surge withstanding	6
2019/4/24	21	1. "Protrusion length": "2.0max (Or the end of lead wire may be inside the tape.)" revised to "+0.5to-1.0 (Or the end of lead wire may be inside the tape.)" 2. Add "AS"& "AT" taping type. 3. Add "Soldering Recommendation"	7~8 8 19
2019/12/11	22	1. Review the Available lead code of Lead Configuration 2. Add "8.3 Label samples "	5 15

Table of Contents

No.	Item	Page
1	Part number for SAP system	4
2	Mechanical	5
3	Part numbering/T.C/Capacitance/ Tolerance/Diameter	6
4	Taping Format	7~8
5	Marking	9
6	Scope	10
7	Specification and test method	11~14
8	Packing specification	15
9	Notices	16~17
10	Soldering Recommendation	18
11	Drawing of Internal Structure and material list	19



1. Part number for SAP system:

(Ex.) YU 0 AH 472 M 13 0 L 20 C 0 H
(1) (2)-1 (2)-1 (3) (4) (5) (6) (7) (8) (9) (10) (11)

(1)Temperature characteristic (identified code)

CODE	Temperature characteristic	Cap. Change
SL	SL	-1000~+350ppm/°C (+20°C~+85°C)
YP	Y5P	±10%
YU	Y5U	-55% to +20%
YV	Y5V	-80% ~ +30%

(2)-1 Rated voltage(identified by 1-figure code) : 0=X1:400V~/Y1:250V~, 1=X1:400V~/Y1:400V~

(2)-2 Type(identified by 2-figure code) : AH

(3)Capacitance (identified by 3-figure code):EX.221=220pF

(4)Capacitance tolerance (identified by code): J:±5%,K:±10%,M:±20%

(5)Nominal body diameter dimension (identified by 2-figure code) : 06--Dmax7.0mm, 07--Dmax8.0mm...

(6)Internal code: 0--Normal, other code--Special control

(7)Lead Style : Refer to “2. Mechanical”.

(8)Packing mode and lead length (identified by 2-figure code)

Taping Code	Description
AM	Ammo box and product pitch : 25.4 mm
AS	Ammo box and product pitch : 15.0 mm (Only for the SAP part number 11-12 digits ≤ 11)
AT	Ammo box and product pitch : 30.0 mm

Bulk Code	Description
03	Lead length : 3.0mm
3E	Lead length : 3.5mm
04	Lead length : 4.0mm
4E	Lead length : 4.5mm
20	Lead length : 20mm

(9)Length tolerance

Code	Description	
A	±0.5 mm (only for kink lead type)	Short lead
B	±1.0 mm	Short lead
C	Min.	Long lead
D	Taping special purpose	Taping

(10)Pitch

Code	Description
0	10±1 mm
A	10±0.5 mm
C	12.5± 0.8 mm

(11)Epoxy Resin Code

Code	Description
B	Halogen and Pb free, epoxy resin.
H	

SAFETY STANDARDS REGULATED, REINFORCED INSULATION TYPE, AH SERIES	POE-D10-00-E-22	Ver: 22	Page: 5 / 19
--------------------------------------------------------------------------	-----------------	---------	--------------

2. Mechanical:

Encapsulation : Epoxy resin, flammability UL94 V-0

Available lead code (unit: mm):

Lead type	SAP P/N (13-17)digits	Pitch (F)	Lead Length (L)	Packing	Lead Configuration
Lead style : L or B Type L or B Straight lead	L03B0	10 ± 1.0	3.0 ± 1.0	Bulk	
	L4EB0	10 ± 1.0	4.5 ± 1.0		
	L05B0	10 ± 1.0	5.0 ± 1.0		
	L03BC	12.5 ± 0.8	3.0 ± 1.0		
	L4EBC	12.5 ± 0.8	4.5 ± 1.0		
	L05BC	12.5 ± 0.8	5.0 ± 1.0		
	L20C0	10 ± 1.0	20 min.		
	L20CC	12.5 ± 0.8	20 min.		
	BAMD0	10 ± 1.0	Refer to "4. Taping format"	Tap. Ammo	
	BASD0	10 ± 1.0			
BATD0	10 ± 1.0				
Lead style : G Type G Straight lead	G03B0	10 ± 1.0	3.0 ± 1.0	Bulk	
	G4EB0	10 ± 1.0	4.5 ± 1.0		
	G05B0	10 ± 1.0	5.0 ± 1.0		
	GAMD0	10 ± 1.0	Refer to "4. Taping format"	Tap. Ammo	
	GASD0	10 ± 1.0			
	GATD0	10 ± 1.0			
Lead style : D Type D Vertical kink lead	D03A0	10 ± 1.0	3.0 ± 0.5	Bulk	
	D3EA0	10 ± 1.0	3.5 ± 0.5		
	D04A0	10 ± 1.0	4.0 ± 0.5		
	D03AC	12.5 ± 0.8	3.0 ± 0.5		
	D3EAC	12.5 ± 0.8	3.5 ± 0.5		
	D04AC	12.5 ± 0.8	4.0 ± 0.5		
	DAMD0	10 ± 1.0	Refer to "4. Taping format"	Tap. Ammo	
	DASD0	10 ± 1.0			
DATD0	10 ± 1.0				
DATD0	10 ± 1.0				
Lead style : X Type X Outside kink lead	X03A0	10 ± 1.0	3.0 ± 0.5	Bulk	
	X3EA0	10 ± 1.0	3.5 ± 0.5		
	X04A0	10 ± 1.0	4.0 ± 0.5		
	X05B0	10 ± 1.0	5.0 ± 1.0		
	X03AC	12.5 ± 0.8	3.0 ± 0.5		
	X3EAC	12.5 ± 0.8	3.5 ± 0.5		
	X04AC	12.5 ± 0.8	4.0 ± 0.5		
	X05BC	12.5 ± 0.8	5.0 ± 1.0		
	XAMD0	10 ± 1.0	Refer to "4. Taping format"	Tap. Ammo	
	XATD0	10 ± 1.0			

* Lead diameter Φd: 0.55 +/-0.05mm

*e (Coating extension on leads): 3.0mm Max for straight lead style, not exceed the kink for kink lead.

SAFETY STANDARDS REGULATED, REINFORCED INSULATION TYPE, AH SERIES	POE-D10-00-E-22	Ver: 22	Page: 6 / 19
--------------------------------------------------------------------------	-----------------	---------	--------------

3. Part numbering/T.C/Capacitance/ Tolerance/Diameter :

SAP P/N	T.C.	Capacitance(pF)	Tolerance	Dimension (unit:mm)						
				D(max.)	T(max.)	F	Φd			
SL*AH***J060*	SL*	10,12,15,18,20,22,24, 27,30,33, 36, 39(pF)	±5%	7.0	5.0	10±1	0.55+/-0.05			
SL*AH***J070*		47,50,51, 56,62(pF)		8.0						
SL*AH***J080*		68,75(pF)		9.0						
SL*AH***J090*		82,100(pF)		10.0						
YP*AH101K060*	Y5P	100 pF	±10%	7.0				5.0	10±1	0.55+/-0.05
YP*AH151K060*		150 pF		7.0						
YP*AH221K060*		220 pF		7.0						
YP*AH331K060*		330 pF		7.0						
YP*AH471K070*		470 pF		8.0						
YP*AH561K080*		560 pF		9.0						
YP*AH681K080*		680 pF		9.0						
YP*AH102K100*		1000 pF		11.0						
YU*AH681M060*	Y5U	680 pF	±20%	7.0	5.0	10±1	0.55+/-0.05			
YU*AH102M070*		1000 pF		8.0						
YU*AH152M080*		1500 pF		9.0						
YU*AH222M090*		2200 pF		10.0						
YU*AH332M110*		3300 pF		12.0						
YU*AH392M120*		3900 pF		13.0						
YU*AH472M130*		4700 pF		14.0						
YV*AH102M060*	Y5V	1000pF	±20%	7.0				5.5	10±1	0.55+/-0.05
YV*AH152M070*		1500pF		8.0						
YV*AH222M080*		2200pF		9.0						
YV*AH332M100*		3300pF		11.0						
YV*AH472M110*		4700pF		12.0						

- The minimum thickness of coating (reinforced insulation) is 0.4mm.

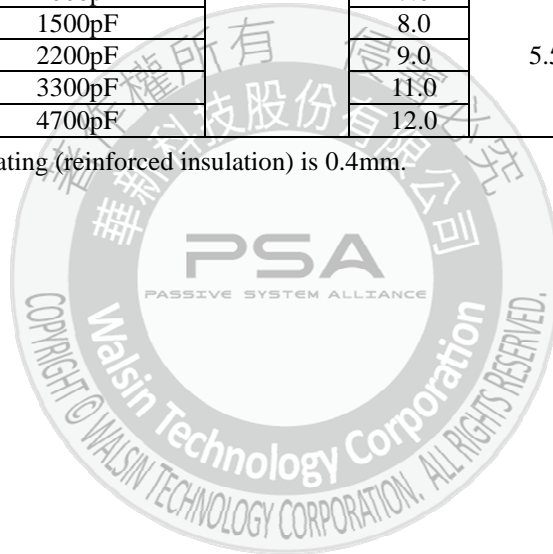

4. Taping Format:

- 25.4mm pitch/lead spacing 10.0mm taping

Lead Code: *BAMD0 & *DAMD0 & *XAMD0 & *GAMD0

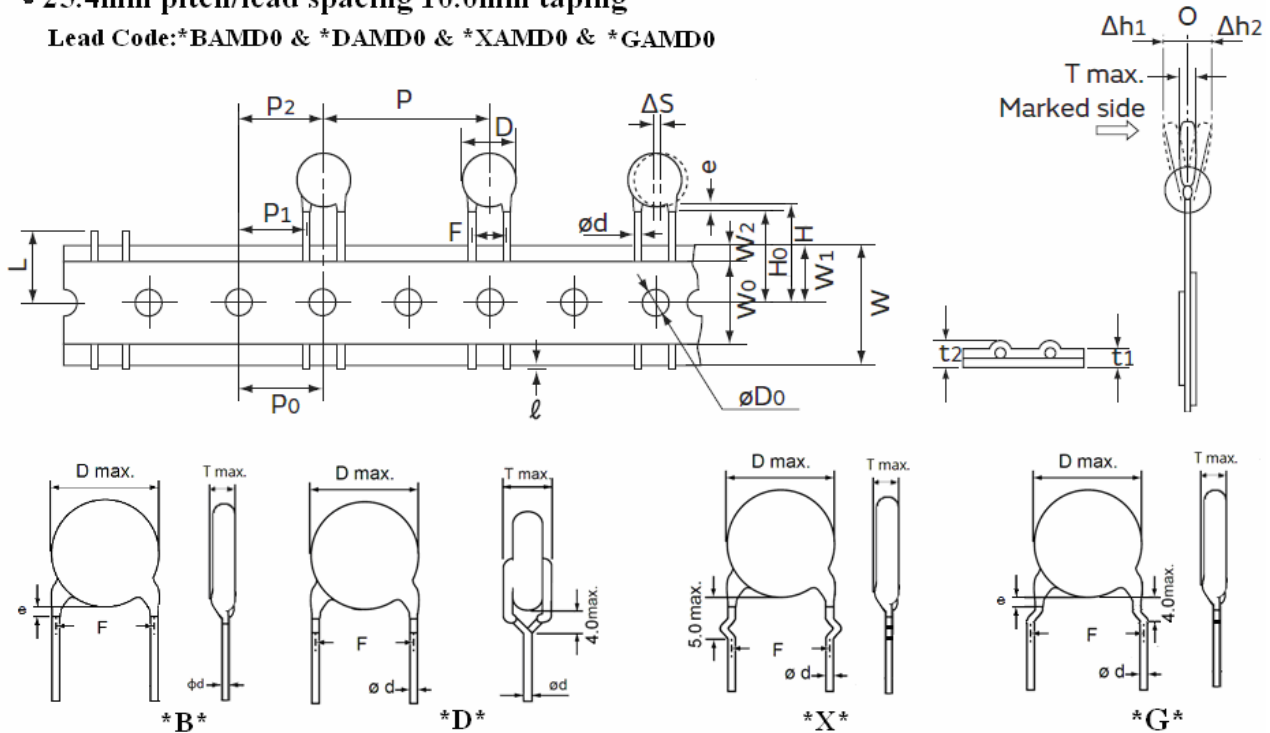

POE Part Number		*BAMD0 / *DAMD0 / *XAMD0 / *GAMD0
Item	Symbol	Dimensions(mm)
Pitch of component	P	25.4 ± 2
Pitch of sprocket	P0	12.7 ± 0.3
Lead spacing	F	10.0 ± 1.0
Length from hole center to component center	P2	12.7 ± 1.5
Length from hole center to lead	P1	7.7 ± 1.5
Body diameter	D	See the "3. Part numbering/T.C/Capacitance/ Tolerance/Diameter"
Deviation along tape, left or right	Δ S	0 ± 2.0
Carrier tape width	W	18.0 +1/ -0.5
Position of sprocket hole	W1	9.0 ± 0.5
Lead distance between the kink and center of sprocket hole	H0	18.0 +2.0/-0 (For: *DAMD0 & *XAMD0 & *GAMD0)
Lead distance between the bottom of body and the center of sprocket hole	H	20.0+1.5/-1.0 (For: *BAMD0)
Length from the terminal of the lead wire to the edge of carrier tape	ℓ	+0.5 to -1.0 (or the end of lead wire may be inside the hole-down tape.)
Diameter of sprocket hole	D0	4.0 ± 0.2
Lead diameter	ød	0.55 ± 0.05
Total tape thickness	t1	0.6 ± 0.3
Total thickness, tape and lead wire	t2	1.5 max.
Deviation across tape	Δ h1	2.0 max.
	Δ h2	2.0 max
Portion to cut in case of defect	L	11.0 max.
Hole-down tape width	W0	8.0 min
Hole-down tape distortion	W2	1.5 ± 1.5
Coating extension on leads	e	3.0mm max for straight lead style; Not exceed the kink leads for kink lead.
Body thickness	T	See the "3. Part numbering/T.C/Capacitance/ Tolerance/Diameter"

**SAFETY STANDARDS REGULATED, REINFORCED
INSULATION TYPE, AH SERIES**

POE-D10-00-E-22

Ver: 22

Page: 8 / 19

- 15mm pitch/lead spacing 10.0mm taping
Lead Code: *BASD0 & *DASD0 & *GASD0

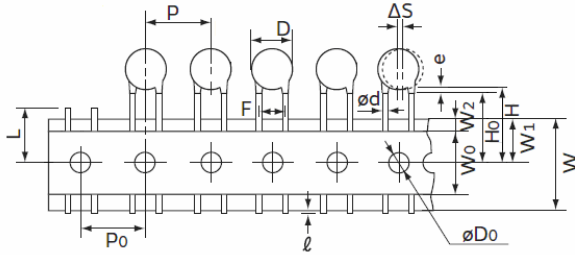

- 30mm pitch/lead spacing 10.0mm taping
Lead Code: *BATD0 & *DATD0 & *XATD0 & *GATD0

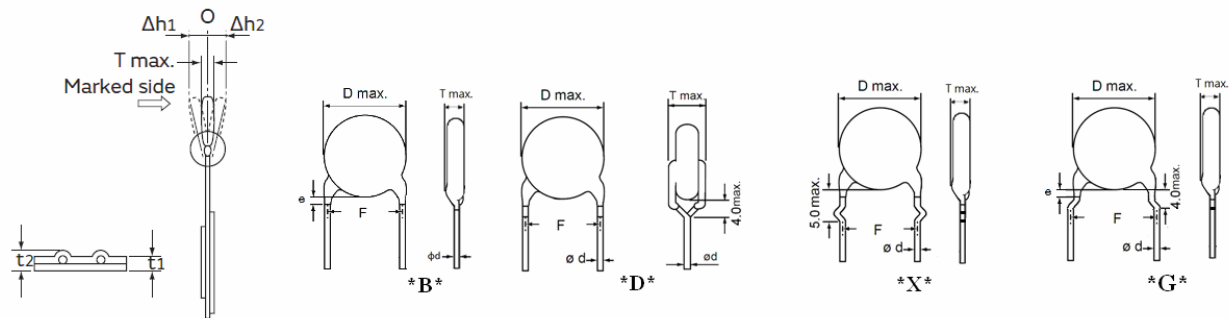
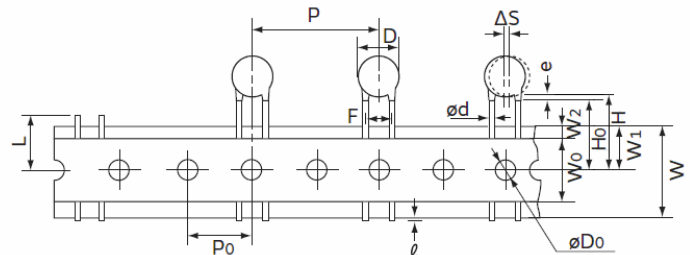

POE Part Number		*BASD0/*DASD0/*GASD0	*BATD0/*DATD0 /*GATD0/*XATD0
Item	Symbol	Dimensions(mm)	
Pitch of component	P	15.0±1	30.0 ± 2
Pitch of sprocket	P0	15.0±0.3	
Lead spacing	F	10.0±1.0	
Body diameter	D	See the “3. Part numbering/T.C/Capacitance/ Tolerance/Diameter”	
Deviation along tape, left or right	Δ S	0 ± 2.0	
Carrier tape width	W	18.0 +1/ -0.5	
Position of sprocket hole	W1	9.0 ± 0.5	
Lead distance between the kink and center of sprocket hole	H0	18.0 +2.0/-0 (For: *DASD0 & *GASD0)	18.0 +2.0/-0 (For: *DATD0 & *GATD0 & *XATD0)
Lead distance between the bottom of body and the center of sprocket hole	H	20.0+1.5/-1.0 (For: *BASD0)	20.0+1.5/-1.0 (For: *BATD0)
Length from the terminal of the lead wire to the edge of carrier tape	ℓ	+0.5 to -1.0 (or the end of lead wire may be inside the hole-down tape.)	
Diameter of sprocket hole	D0	4.0 ± 0.2	
Lead diameter	φd	0.55 ±0.05	
Total tape thickness	t1	0.6 ± 0.3	
Total thickness, tape and lead wire	t2	1.5 max.	
Deviation across tape	Δ h1/Δ h2	2.0 max.	
Portion to cut in case of defect	L	11.0 max.	
Hole-down tape width	W0	8.0 min	
Hole-down tape distortion	W2	1.5 ± 1.5	
Coating extension on leads	e	3.0 max for straight lead style; Not exceed the kink leads for kink lead.	
Body thickness	T	See the “3. Part numbering/T.C/Capacitance/ Tolerance/Diameter”	

SAFETY STANDARDS REGULATED, REINFORCED INSULATION TYPE, AH SERIES	POE-D10-00-E-22	Ver: 22	Page: 9 / 19
--------------------------------------------------------------------------	-----------------	---------	--------------

5. Marking:

1.Type Designation	AH		
2.Nominal Capacitance	Identified by 3-Figure Code. Ex. 47pF→"47" , 470pF→"471"		
3.Capacitance Tolerance	J:±5%,K:±10%,M:±20%		
4.Company Name Code(Trade mark)	UK		
5. Products ID	<p>Abbreviation ex.:</p> <p>Manufacture year: ← 9 C 6 1234 → Last 4 digits of lot no.</p> <p>9:2019 0:2020 1:2021 ... Manufacture month: 1:January 2:February ... 9:September O:October N:November D:December</p> <p>Manufacture: C:Pan overseas (Guangzhou)</p> <p>Epoxy resin code: " _ ": Halogen and Pb free epoxy resin (For the last code "H" and "B" of SAP P/N)</p>		
6.Approved Monogram:			
(1) VDE approval mark		IEC 60384-14 Class Code : X1 : 400V~ , Y1 : 250V~ or 400V~	
(2) UL approval mark		(6) DEMKO approval mark	
(3) CSA approval mark		(7) FIMKO approval mark	
(4) SEMKO approval mark		(8) SEV approval mark	
(5) NEMKO approval mark		(9) CQC approval mark	
Normal marking		YP*AH102K***** (Special marking)	
Two sides (for SAP part number 10-11 digits ≤ "07" products)		One side (for SAP part number 10-11 digits ≥ "08" products)	
<p>0AH:</p> <p>1AH:</p>	<p>0AH:</p> <p>1AH:</p>	<p>0AH</p>	<p>1AH</p>
<p>* Marking by the laser.</p> <p>* "<u>C</u>": Marked with code " _ " stand for Halogen and Pb free epoxy resin.</p> <p>* " • " : Individual specification code, it is added under the lot no.</p>			

SAFETY STANDARDS REGULATED, REINFORCED INSULATION TYPE, AH SERIES	POE-D10-00-E-22	Ver: 22	Page: 10 / 19
--------------------------------------------------------------------------	-----------------	---------	---------------

6. Scope:

THIS SPECIFICATION APPLIES TO CERAMIC INSULATED CAPACITORS DISK TYPE USED IN ELECTRONIC EQUIPMENT.

6.1 Applicable safety standard

This specification applies to the VDE, SEV, SEMKO, FIMKO, NEMKO, DEMKO, KTL, UL, CSA approved ceramic capacitors disc type for antenna coupling, line-by-pass and across-the-line. X1, Y1 capacitor based on IEC60384-14. "UL, CSA recognized capacitor for across-the-line, line-by-pass" and antenna-isolation.

6.2 Safety standards approval and recognized no.

Safety Standard	Standard No.	Subclass	w.v.	Recognized No.
UL	ANSI/UL 60384-14:2013	X1	400VAC	E146544
		Y1	250VAC/400VAC	
CSA	IEC60384-14 (ed.4) 2013	X1	400VAC	2347971
		Y1	250VAC/400VAC	
VDE (ENEC)	EN 60384-14:2013/A1:2016 IEC 6.384-14:2013 IEC 6.384-14:2013/AMD1:2016	X1	400VAC	40001804
		Y1	250VAC/400VAC	
SEV	EN 60384-14:2013 + A1:16	X1	400VAC	18.0652
		Y1	250VAC/400VAC	
SEMKO	EN 60384-14:2013+A1	X1	400VAC	1811992
		Y1	250VAC/400VAC	
FIMKO	EN 60384-14:2013 + A1:16	X1	400VAC	NCS/FI 30462
		Y1	250VAC/400VAC	
NEMKO	EN 60384-14:2013;A1	X1	400VAC	No. P18222946
		Y1	250VAC/400VAC	
DEMKO	EN 60384-14:2013/A1:2016 EN 60384-14:2013	X1	400VAC	D-07609
		Y1	250VAC/400VAC	
CQC	IEC60384-14:2013+AMD1:2016	X1:400VAC /Y1:400VAC		CQC03001003673
	GB/T6346.14-2015	X1:400VAC /Y1:250VAC		CQC11001055510
KTL	KC60384-1(2015-09)	X1	400VAC	SU03065-14004A
	KC60384-14(2015-09)	Y1	250VAC	SU03065-14005A
	IEC 60384-14(ed.3)	Y1	400VAC	SU03065-14006A

SAFETY STANDARDS REGULATED, REINFORCED INSULATION TYPE, AH SERIES	POE-D10-00-E-22	Ver: 22	Page: 11 / 19
--------------------------------------------------------------------------	-----------------	---------	---------------

7. Specification and test method:

7.1 Operating Temperature Range: -40 to +125°C

7.2 Test condition:

Test and measurement shall be made at the standard condition. (temperature 15~35°C, relative humidity 45~75% and atmospheric pressure 860~1060hpa). Unless otherwise specified herein.

If doubt occurred on the value of measurement, and measurement was requested by customer capacitors shall be measured at the reference condition. (temperature 20±2°C or 25 ± 2°C, relative humidity 60~70% and atmospheric pressure 860~1060hpa.)

7.3 Performance:

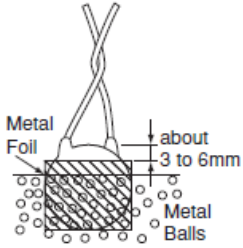
No	Items	Performance	Testing method																						
7.3.1	Appearance And dimension	No visible defect, and dimensions are within specified range.	The capacitor should be visually inspected for evidence of defect. Dimensions should be measured with slide calipers.																						
7.3.2	Marking	To be easily legible.	The capacitor should be visually inspected.																						
7.3.3	Between terminals	No failure.	The capacitors shall not be damage when AC4000V (rms.) are applied between the lead wires for 60sec. (Charge/Discharge current ≤ 50mA.)																						
	Dielectric Strength Body Insulation	No failure.	<p>First, the terminals of the capacitor should be connected together.</p> <p>Then, a metal foil should be closely wrapped around the body of the capacitor to the distance of about 3 to 6mm from each terminal. Then, the capacitor should be inserted into a container filled with metal balls of about 1mm diameter.</p> <p>Finally, AC4000V (r.m.s.)<50/60Hz> is applied for 60 s between the capacitor lead wires and metal balls. (Charge/Discharge current ≤ 50mA.)</p> 																						
7.3.4	Insulation Resistance	Between terminals 10000MΩ or more.	The insulation resistance shall be measured with DC500±50V within 60±5sec of charging.																						
7.3.5	Capacitance	Within specified tolerance.	Y5P&Y5U&Y5V: The capacitance should be measured at 20°C with 1±0.2kHz and AC5V(r.m.s.) max. SL: The capacitance shall be measured at 25°C with 1MHz±20% and 1.0±0.2Vrms																						
7.3.6	Dissipation Factor(tanδ) or Q	Y5P、Y5U : D.F.≤2.5% Y5V : D.F.≤5.0% SL : 30pF&above: ≥ 1000 Below 30PF: ≥ 400+20×C																							
7.3.7	Temperature Characteristic	<table border="1"> <thead> <tr> <th>Char.</th> <th>Capacitance Change</th> </tr> </thead> <tbody> <tr> <td>Y5P</td> <td>Within ± 10%</td> </tr> <tr> <td>Y5U</td> <td>Within ±²⁰/₅%</td> </tr> <tr> <td>Y5V</td> <td>Within -80 ~ +30%</td> </tr> <tr> <td>SL</td> <td>-1000 ~ +350 ppm/°C (+20°C ~ +85°C)</td> </tr> </tbody> </table>	Char.	Capacitance Change	Y5P	Within ± 10%	Y5U	Within ± ²⁰ / ₅ %	Y5V	Within -80 ~ +30%	SL	-1000 ~ +350 ppm/°C (+20°C ~ +85°C)	<p>The capacitance measurement shall be made at each step specified in Table 1.</p> <table border="1"> <thead> <tr> <th>Step</th> <th>1</th> <th>2</th> <th>3</th> <th>4</th> <th>5</th> </tr> </thead> <tbody> <tr> <td>Temp.(°C)</td> <td>+20±2</td> <td>-25±2</td> <td>+20±2</td> <td>+85±2</td> <td>+20±2</td> </tr> </tbody> </table> <p>Pre-treatment: Capacitor shall be stored at 125±2°C for 1hour, then placed at *1 room condition for 24±2hours before measurements.</p>	Step	1	2	3	4	5	Temp.(°C)	+20±2	-25±2	+20±2	+85±2	+20±2
		Char.	Capacitance Change																						
Y5P	Within ± 10%																								
Y5U	Within ± ²⁰ / ₅ %																								
Y5V	Within -80 ~ +30%																								
SL	-1000 ~ +350 ppm/°C (+20°C ~ +85°C)																								
Step	1	2	3	4	5																				
Temp.(°C)	+20±2	-25±2	+20±2	+85±2	+20±2																				
7.3.8	Solderability of Leads	Lead wire should be soldered with uniform coating on the axial direction over 3/4 of the circumferential direction.	The lead wire of capacitor should be dipped into molten solder for 5 ± 0.5 sec. The depth of immersion is up to about 1.5 to 2.0 mm from the root of lead wires. Temp. of solder : Lead Free Solder (Sn-3Ag-0.5Cu) 245±5°C																						

※ "room condition" temperature : 15~35°C, humidity : 45~75%,atmospheric pressure : 86~106kPa

※ "C" expresses nominal capacitance value (pF).

SAFETY STANDARDS REGULATED, REINFORCED INSULATION TYPE, AH SERIES	POE-D10-00-E-22	Ver: 22	Page: 12 / 19
--------------------------------------------------------------------------	-----------------	---------	---------------

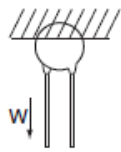
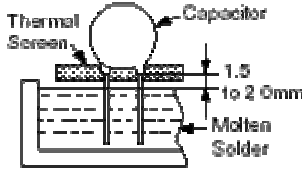
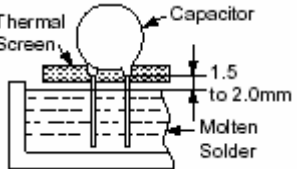
No	Items	Performance	Testing method
7.3.9	Robustness of Terminations	Tensile Lead wire shall not cut off capacitor shall not be broken.	As shown in the figure at right, fix the body of the capacitor and apply a tensile weight gradually to each lead wire in the radial direction of the capacitor up to 10N and keep it for 10±1 sec. 
		Bending Lead wire shall not cut off. Capacitor shall not be broken.	With the termination in its normal position, the specimen is held by its body in such a manner that the axis of the termination is vertical; a mass applying a force of 5N is then suspended from the end of the termination. The body of the specimen is then inclined, within a period of 2 to 3sec, through an angle of approximately 90° in the vertical plane and then returned to its initial position over the same period of time; this operation constitutes one bend. One bend immediately followed by a second bend in the opposite direction.
7.3.10	Soldering Effect (Non-Preheat)	Appearance No marked defect.	As shown in figure, the lead wires should be immersed in solder of 350 ± 10 °C or 260 ± 5 °C up to 1.5 to 2.0 mm from the root of terminal for 3.5 ± 0.5 sec (10 ± 1 sec. for 260 ± 5 °C). 
		I.R. 1000 MΩ min.	
		Dielectric Strength Per item 7.3. 3	
		Capacitance Change Y5P,Y5U,Y5V : Within ±10 % SL : Within±2.5% or ±0.25pF,Whichever is large.	
7.3.11	Soldering Effect (On-Preheat)	Appearance No marked defect.	First the capacitor should be stored at 120+0/-5 °C for 60 +0/-5 sec. Then , as in figure , the lead wires should be immersed solder of 260+0/-5 °C up to 1.5 to 2.0 mm from the root of terminal for 7.5+0/-1 sec. 
		I.R. 1000 MΩ min.	
		Dielectric Strength Per item 7.3.3	
		Capacitance Change Y5P,Y5U,Y5V : Within ±10 % SL : Within±2.5% or ±0.25pF,Whichever is large.	

※ "room condition" temperature : 15~35°C, humidity : 45~75%,atmospheric pressure : 86~106kPa

※ "C" expresses nominal capacitance value (pF).

SAFETY STANDARDS REGULATED, REINFORCED INSULATION TYPE, AH SERIES	POE-D10-00-E-22	Ver: 22	Page: 13 / 19
--------------------------------------------------------------------------	-----------------	---------	---------------

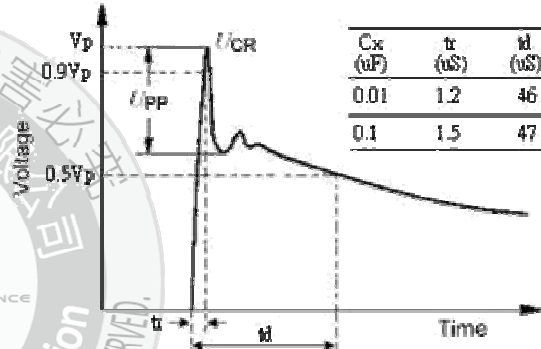
No	Items	Performance	Testing method									
7.3.12	Appearance	No marked defect.	Set the capacitor for 500±12hours at 40±2°C in 90 to 95% relative humidity. Then capacitor shall be stored for 1 to 2 hours at *1room condition. Pre-treatment: Capacitor shall be stored at 125±2°C for 1hour.then placed at*1room condition for 24±2hours. Post-treatment: Capacitor shall be stored for 1 to 2hours at *1room condition.									
	Capacitance Change	Y5P : Within ±10% Y5U : Within ±20% Y5V : Within ±30% SL : Within±2.5% or ±0.25pF,Whichever is large.										
	D.F.	Y5P,Y5U : 5.0% max. Y5V : 7.5% max.										
	Q	SL : Q ≥ 100+10×C/3 (C < 30pF) Q ≥ 200 (C ≥ 30pF)										
7.3.13	Humidity Loading	I.R.	Apply the rated voltage for 500±12 hours at 40±2°C in 90 to 95% relative humidity Pre-treatment: Capacitor shall be stored at 125±2°C for 1hour.then placed at*1room condition for 24±2hours. Post-treatment: Capacitor shall be stored for 1 to 2hours at *1room condition.									
		Dielectric Strength		Per Item 7.3.3								
	Dielectric Strength	Per Item 7.3.3										
7.3.14	Life	Appearance	Impulse Voltage Each individual capacitor shall be subjected to 8kV impulses for three times. After the capacitors are applied to life test.  <table border="1" data-bbox="1260 1052 1468 1176"> <thead> <tr> <th>Cx (uF)</th> <th>tr (uS)</th> <th>td (uS)</th> </tr> </thead> <tbody> <tr> <td>0.01</td> <td>1.2</td> <td>46</td> </tr> <tr> <td>0.1</td> <td>1.5</td> <td>47</td> </tr> </tbody> </table>	Cx (uF)	tr (uS)	td (uS)	0.01	1.2	46	0.1	1.5	47
		Cx (uF)		tr (uS)	td (uS)							
		0.01		1.2	46							
		0.1		1.5	47							
Capacitance Change	Y5P&Y5U&Y5V : Within ±20% SL : Within±3% or ±0.3pF,Whichever is large.											
I.R.	3000MΩ min. SL : 1000MΩ min.											
Dielectric Strength	Per Item 7.3.3											
The specimen capacitors are placed in a circulating air oven for a period of 1000 hours. The air in the oven is maintained at a temperature of 125±3°C. Throughout the test, the capacitors are subjected to an AC425Vrms.(for 0AH type) or AC680Vrms.(for 1AH type) alternating voltage of mains frequency, except that once each hour the voltage is increased to AC1000V(rms.) for 0.1 sec.												
Pre-treatment: Capacitor shall be stored at 125±2°C for 1hour.then placed at*1room condition for 24±2hours. Post-treatment: Capacitor shall be stored for 1 to 2hours at *1room condition.												

※ "room condition" temperature : 15~35°C, humidity : 45~75%,atmospheric pressure : 86~106kPa

※ "C" expresses nominal capacitance value (pF).

SAFETY STANDARDS REGULATED, REINFORCED INSULATION TYPE, AH SERIES	POE-D10-00-E-22	Ver: 22	Page: 15 / 19
--------------------------------------------------------------------------	-----------------	---------	---------------

8.Packing Baggage :

8.1 Packing size:

Type	Box	Carton	
Bulk			
Ammo taping			

8.2 Packing quantity:

Packing type	The code of 14th to15th in SAP P/N	MPQ (Kpcs/Box)
Taping	AM (The size code ≤ 11)	1
	AM (The size code ≥ 12)	0.5
	AS	1
	AT	0.5

Packing type	Lead length	Size code of 10th to 11th in SAP P/N	MPQ (Kpcs/Bag)	Kpcs/Box
Bulk	Long lead ($L \geq 20\text{mm}$)	06~12	0.5	1.5
		13-15	0.5	1
	Short lead ($L < 20\text{mm}$)	06~14	0.5	2
		15	0.2	1
	All	16	0.2	1

8.3 Label samples

CUST P/N: 2580AH133KCPAKLF		UK		UL	
NEW POE P/N: YP0AH331K060DAMD0B		QTY:1000 PCS		10 0°C 15 D	
POE P/N: YP0AH331K060DAMD0B		TOL: + -10%		SF cec KC S	
CAP:330pF		T.C: Y5P		FI N S	
VOLT:X1:400VAC, Y1:250VAC		DATE:2018.03.30		Pb HF RoHS	
LOT NO.: 741HK01054		PAN OVERSEAS(GUANGZHOU) ELECTRONIC CO.,LTD.		UL 60384-14 IEC 60384-14 40/125/21/C	
R001					

9. Notices:

9.1 Caution (Rating):

(1). Operating Voltage

Be sure to maintain the V_{p-p} value of the applied voltage or the V_{0-p} which contains DC bias within the rated voltage range.

When the voltage is started to apply to the circuit or it is stopped applying, the irregular voltage may be generated for a transit period because of resonance or switching. Be sure to use a capacitor within rated voltage containing this irregular voltage.

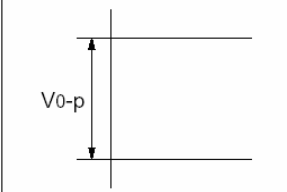
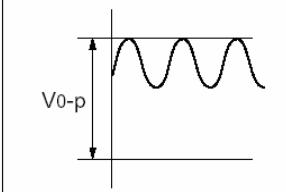
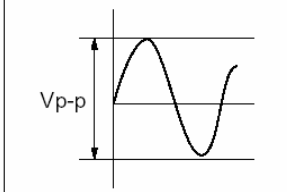
Voltage	DC Voltage	DC+AC Voltage	AC Voltage
Positional measurement			

(2). Operating Temperature and Self-generated Heat

Keep the surface temperature of a capacitor below the upper limit of its rated operating temperature range. Be sure to take into account the heat generated by the capacitor itself.

(3). Test condition for withstanding Voltage

I. Test Equipment

Test equipment for AC withstanding voltage shall be used with the performance of the wave similar to 50/60 Hz sine waves.

If the distorted sine wave or over load exceeding the specified voltage value is applied, the defective may be caused.

II. Voltage Applied Method

When the withstanding voltage is applied, capacitor's lead or terminal shall be firmly connected to the output of the withstanding voltage test equipment, and then the voltage shall be raised from near zero to the test voltage.

If the test voltage without the raise from near zero voltage would be applied directly to capacitor, test voltage should be applied with the *zero cross. At the end of the test time, the test voltage shall be reduced to near zero, and then capacitor's lead or terminal shall be taken off the output of the withstanding voltage test equipment.

If the test voltage without the raise from near zero voltage would be applied directly to capacitor, the surge voltage may arise, and therefore, the defective may be caused.

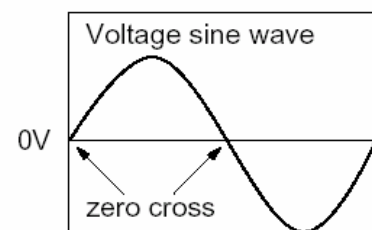

ZERO CROSS is the point where voltage sine wave pass 0V.- See the right figure.

(4). Fail-Safe

When capacitor would be broken, failure may result in a short circuit. Be sure to provide an appropriate fail-safe function like a fuse on your product if failure would follow an electric shock, fire or fume.

Failure to follow the above cautions may result, worst case, in a short circuit and cause fuming or partial dispersion when the product is used.

9.2 Caution (Storage and operating condition):

Operating and storage environment

The insulating coating of capacitors does not form a perfect seal; therefore, do not use or store capacitors in a corrosive atmosphere, especially where chloride gas, sulfide gas, acid, alkali, salt or the like are present. And avoid exposure to moisture. Before cleaning, bonding, or molding this product, verify that these processes do not affect product quality by testing the performance of a cleaned, bonded or molded product in the intended equipment. Store the capacitors where the temperature and relative humidity do not exceed -10 to 40 degrees centigrade and 15 to 85 % for 6 months maximum and use within the period after receiving the capacitors.

"Failure to follow the above cautions may result, worst case, in a short circuit and cause fuming or partial dispersion when the product is used."

9.3 Caution (Soldering and Mounting):

9.3.1 Vibration and impact:

Do not expose a capacitor or its leads to excessive shock or vibration during use.

9.3.2 Soldering

When soldering this product to a PCB/PWB, do not exceed the solder heat resistance specification of the capacitor. Subjecting this product to excessive heating could melt the internal junction solder and may result in thermal shocks that can crack the ceramic element.

When soldering capacitor with a soldering iron, it should be performed in following conditions.

Temperature of iron-tip: 400 degrees C. max.

Soldering iron wattage: 50W max.

Soldering time: 3.5 sec. max.

9.3.3 Cleaning (ultrasonic cleaning):

To perform ultrasonic cleaning, observe the following conditions.

Rinse bath capacity: Output of 20 watts per liter or less.

Rinsing time: 5 min maximum.

Do not vibrate the PCB/PWB directly.

Excessive ultrasonic cleaning may lead to fatigue destruction of the lead wires.

"Failure to follow the above cautions may result, worst case, in a short circuit and cause fuming or partial dispersion when the product is used."

9.4 Caution (Handling):

Vibration and impact

Do not expose a capacitor or its leads to excessive shock or vibration during use.

"Failure to follow the above cautions may result, worst case, in a short circuit and cause fuming or partial dispersion when the product is used."

10. Soldering Recommendation:

10.1 Wave Soldering Profile:

- Temperature conditions of the flow is recommended as shown in the chart
- Must implement the pre-heat
- Maximum peak flow temperature is recommended 265°C
- Time “T” implement in the chart recommended within 20 sec. if temperature exceed 200°C
- Take care with the flow solder not to touch the capacitor body directly at mounting

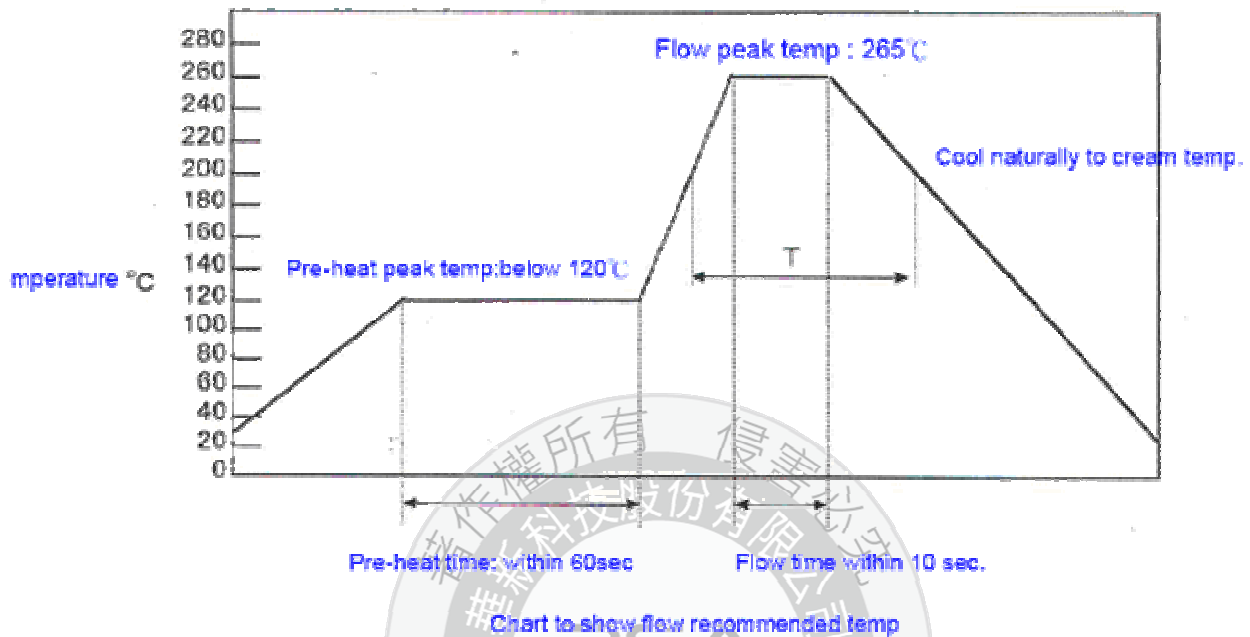

10.2 Recommended Reworking Conditions with Soldering Iron :

- Temperature of iron-tip: 400 degrees C. max.
- Soldering iron wattage: 50W max.
- Soldering time: 3.5 sec. max.
- Distance from coating body: 2 mm (min.)

10.3 Reflow-Soldering : Lead Ceramic Cap. should not be soldered by reflow-soldering.

11. Drawing of internal structure and material list :

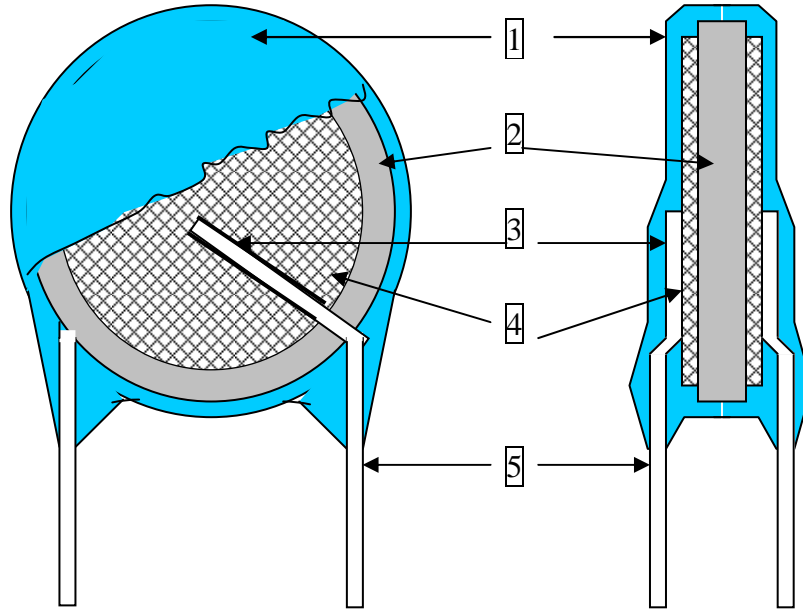

Remarks :

No.	Part name	Material	Model/Type	Component
1	Insulation Coating	Epoxy polymer	EF-150 PCE-300 ECP-357	Epoxy resin、 Pigment (Blue / UL 94 V-0) The minimum thickness of coating (reinforced insulation) is 0.4mm
2	Dielectric Element	Ceramic	SL/Y5P/Y5U/Y5V	BaTiO ₃
3	Solder	Tin-silver	Sn96.5-Ag3-Cu0.5	Sn96.5-Ag3-Cu0.5
4	Electrodes	Ag	SP-160PL SP-260PL	Silver 、 Glass frit
5	Leads wire	Tinned copper clad steel wire	0.55±0.05mm	Substrate metal: Fe & Cu Surface plating: Sn 100%(3~7μm)

X-ON Electronics

Largest Supplier of Electrical and Electronic Components

Click to view similar products for [Safety Capacitors](#) category:

Click to view products by [Walsin](#) manufacturer:

Other Similar products are found below :

[B32022B3223K026](#) [B32912A3104K026](#) [46KF310050P0K](#) [46KI3470DQM1K](#) [B32913A3154K](#) [MKPY2-.02230020P15](#) [46KN333000M1M](#)
[46KN422000P0M](#) [DE1E3KX222MJ4BN01F](#) [46KR422000M1K](#) [HUB2200-S](#) [46KF268000M1M](#) [46KI3150NDM2M](#)
[PHE840MD6220MD13R30](#) [PHE840MY6470MD14R06](#) [PHE845VD5470MR06](#) [R463N4100ZAM1K](#) [MKPX2R-1/400/10P27](#)
[YP500101K040B20C2P](#) [YU0AH222M090DAMD0B](#) [LS1808N102K302NX080TM](#) [CY1471KE1IEB46X2A2](#) [CY1222ME5IEE48O2A2](#)
[MPX474K31DTEV158G0](#) [H472M080FQ55250L750A](#) [CY1471ME19EE45W2A2](#) [MPX104K31D2KN158HF](#) [MPX224K31D2KN158G0](#)
[PX104K2W1502](#) [YU1AH222M090DASD0H](#) [C47S1472K60C000](#) [MP2224K32C5J6LC](#) [H102M050FQ55250L750A](#) [MP2474K32D6R8LC](#)
[MP2224K32C3J6LC](#) [MP2104K32C3J6LC](#) [PX334K2C1006](#) [YU0AC222M080L20C7B](#) [MP2473K27B2X6LC](#) [MP2224K32D4J8LC](#)
[MP2684K32D6T8LC](#) [ST3Y1Y5U332M500VAC](#) [ST3Y1Y5V472M500VAC](#) [MP2474K32D4X8LC](#) [MP2474K32D4J8LC](#)
[YU0AH332M110L4EB0B](#) [CY1681ME1IEE45S2A2](#) [Y1220J-E1I-B4-AC400V](#) [Y1120K-E1I-B4-AC400V](#) [MP2154K32D2R8LC](#)