

### Features

- Small Body Outline Dimensions:  
0.039" x 0.024" (1.0 mm x 0.60 mm)
- Protects one I/O or power line
- Low Clamping Voltage
- Ultra Low Capacitance:0.5pF
- Working Voltage: 5 V
- Low Leakage Current

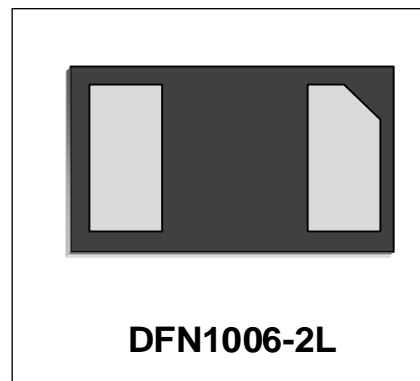

### IEC COMPATIBILITY (EN61000-4)

- IEC 61000-4-2 (ESD)  $\pm 15\text{kV}$  (air),  $\pm 10\text{kV}$  (contact)
- IEC 61000-4-4 (EFT) 40A (5/50ns)
- IEC 61000-4-5 (Lightning) 3A (8/20 $\mu\text{s}$ )

### Mechanical Characteristics

- DFN1006-2L package
- Marking: Marking Code
- Packaging: Tape and Reel per EIA 481
- RoHS Compliant

### Applications

- Laptop Computers
- Cellular Phones
- Digital Cameras
- Personal Digital Assistants (PDAs)

### Schematic & PIN Configuration

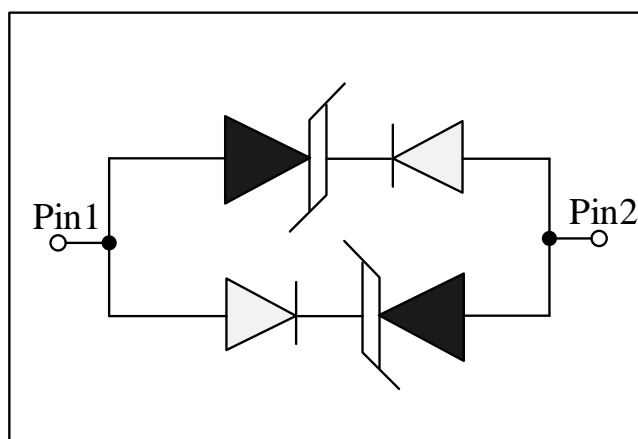

Absolute Maximum Rating			
Rating	Symbol	Value	Units
Peak Pulse Power ( $t_p = 8/20\mu s$ )	$P_{PP}$	60	W
Peak Pulse Current ( $t_p = 8/20\mu s$ )	$I_{PP}$	3	A
Operating Temperature	$T_J$	-55 to + 125	°C
Storage Temperature	$T_{STG}$	-55 to +150	°C

### Electrical Parameters (T=25°C)

Symbol	Parameter
$I_{PP}$	Reverse Peak Pulse Current
$V_C$	Clamping Voltage @ $I_{PP}$
$V_{RWM}$	Reverse Stand-Off Voltage
$I_R$	Reverse Leakage Current @ $V_{RWM}$
$V_{BR}$	Breakdown Voltage @ $I_T$
$I_T$	Test Current

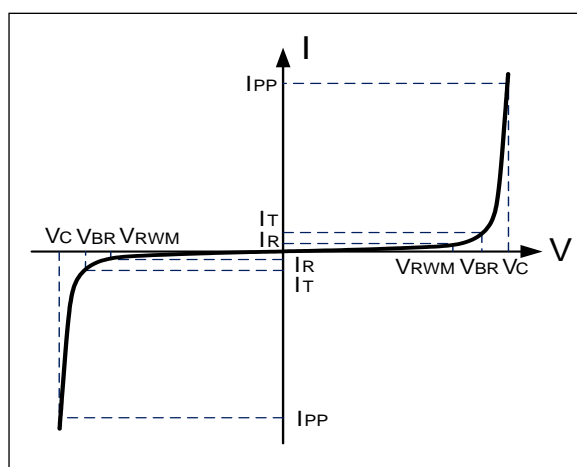

### Electrical Characteristics

WE05DUCF-B						
Parameter	Symbol	Conditions	Minimum	Typical	Maximum	Units
Reverse Stand-Off Voltage	$V_{RWM}$				5	V
Reverse Breakdown Voltage	$V_{BR}$	$I_T = 1\text{mA}$	6			V
Reverse Leakage Current	$I_R$	$V_{RWM} = 5\text{V}, T = 25^\circ\text{C}$			150	nA
Clamping Voltage	$V_C$	$I_{PP} = 3\text{A}, t_p = 8/20\mu s$			20	V
ESD Clamping Voltage <sup>1</sup>	$V_C$	$I_{PP} = 4\text{A}$ $t_p = 0.2/100\text{ns}$		14.2		V
ESD Clamping Voltage <sup>1</sup>	$V_C$	$I_{PP} = 16\text{A}$ $t_p = 0.2/100\text{ns}$		28		V
Dynamic Resistance <sup>1,2</sup>	$R_{DYN}$	TLP=0.2/100ns		1.15		$\Omega$
Junction Capacitance	$C_j$	$V_R = 0\text{V}, f = 1\text{MHz}$		0.5	0.8	pF

**Note:** 1、 TLP Setting :  $t_p = 100\text{ns}, t_r = 0.2\text{ns}, I_{TLP}$  and  $V_{TLP}$  sample window:  $t_1 = 70\text{ns}$  to  $t_2 = 90\text{ns}$ .  
 2、 Dynamic resistance calculated from  $I_{PP} = 4\text{A}$  to  $I_{PP} = 16\text{A}$  using "Best Fit".

Typical Characteristics

Figure 1: Peak Pulse Power vs. Pulse Time

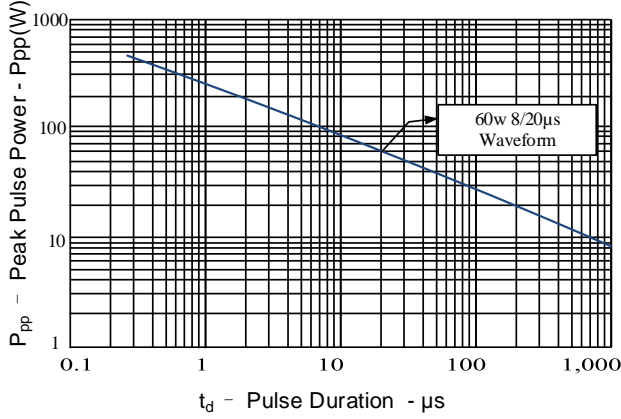

Figure 2: Power Derating Curve

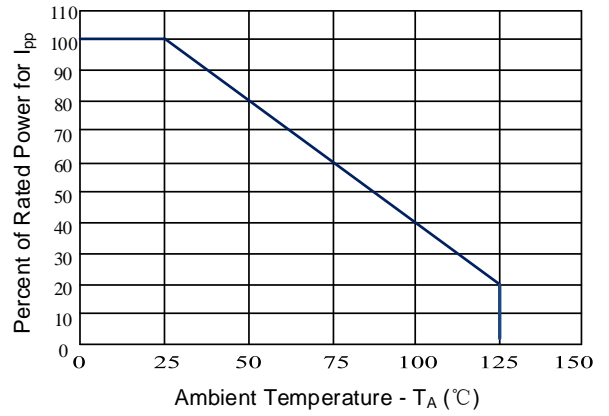

Figure 3: Clamping Voltage vs. Peak Pulse Current

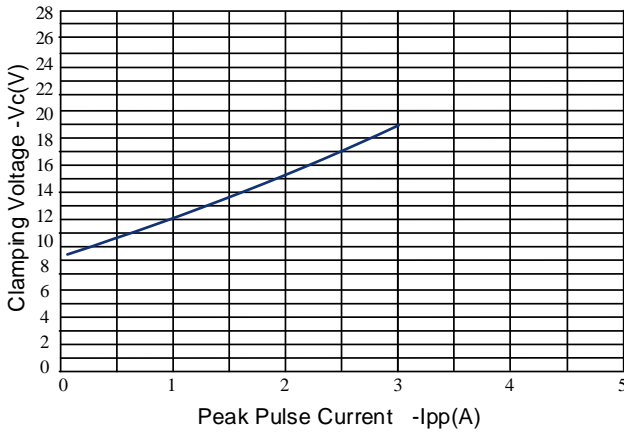

Figure 4: Normalized Junction Capacitance

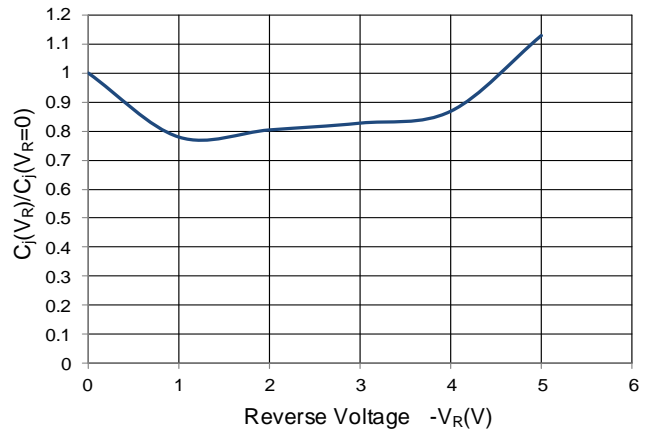

Figure 5: TLP Positive I-V Curve

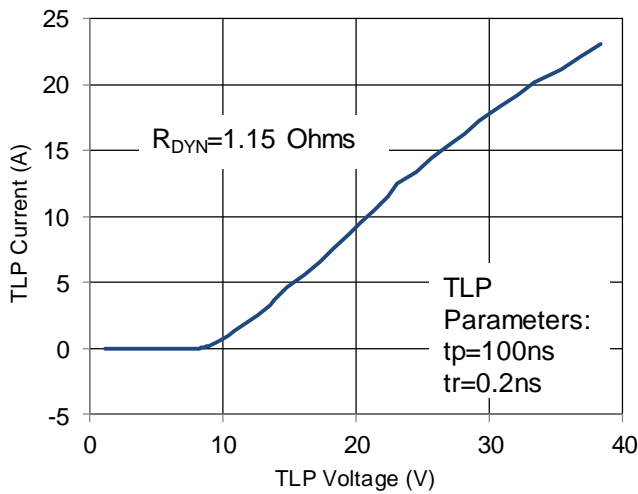
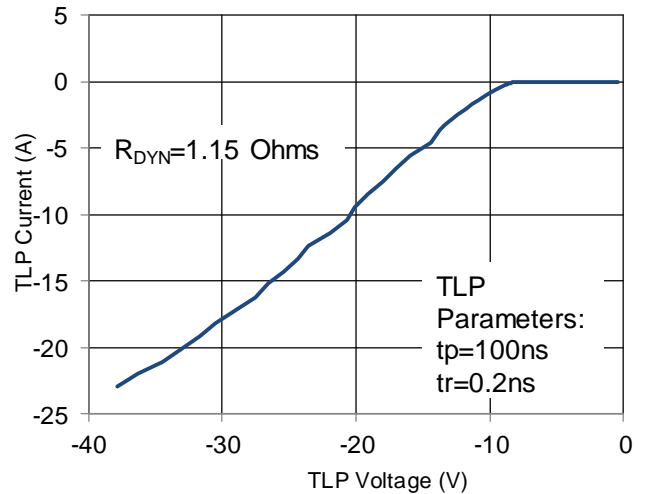
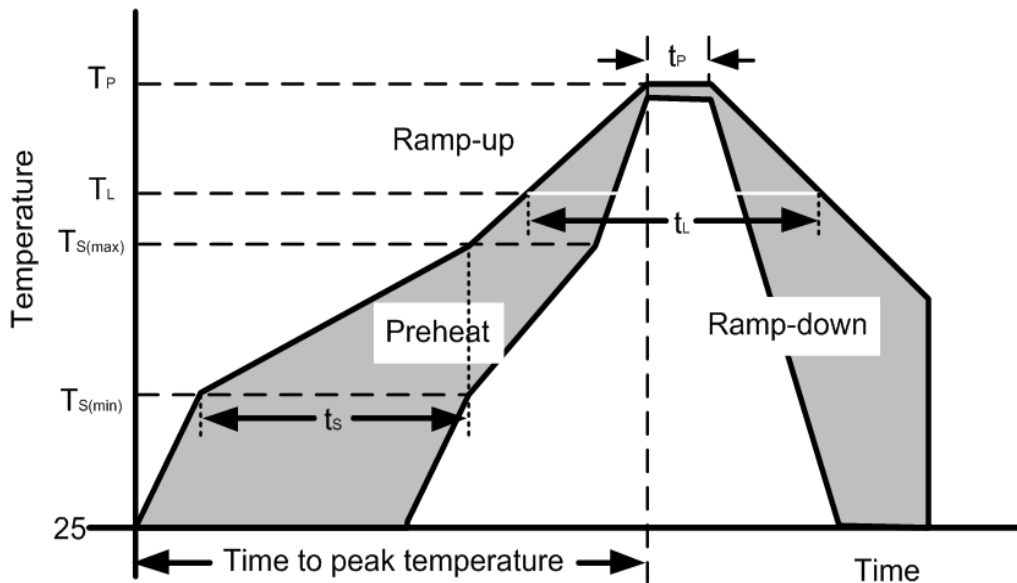

Figure 6: TLP Negative I-V Curve



Soldering Parameters

Reflow Condition		Pb – Free assembly
Pre Heat	Temperature Min ( $T_{S(min)}$ )	150°C
	Temperature Max ( $T_{S(max)}$ )	200°C
	Time (min to max) ( $t_s$ )	60 – 190 secs
Average ramp up rate (Liquidus Temp) ( $T_L$ ) to peak		5°C/second max
$T_{S(max)}$ to $T_L$ —Ramp-up Rate		5°C/second max
Reflow	Temperature ( $T_L$ ) (Liquidus)	217°C
	Temperature ( $t_L$ )	60 – 150 seconds
Peak Temperature ( $T_P$ )		260+0/-5 °C
Time within actual peak Temperature ( $t_p$ )		20 – 40 seconds
Ramp-down Rate		5°C/second max
Time 25°C to peak Temperature ( $T_P$ )		8 minutes Max.
Do not exceed		280°C



Outline Drawing –DFN1006-2L

**PACKAGE OUTLINE**

BOTTOM VIEW

DFN1006-2L

SYMBOL	MILIMETER		
	MIN	NOM	MAX
A	0.45	0.50	0.55
A1	0	0.02	0.05
b	0.45	0.50	0.55
C	0.12	0.15	0.18
D	0.95	1.00	1.05
e	0.65BSC		
E	0.55	0.60	0.65
L	0.20	0.25	0.30
L1	0.05REF		
h	0.07	0.12	0.17

**Land Pattern**

**Marking Codes**

Part Number	Marking Code
WE05DUCF-B	<div style="border: 1px solid black; padding: 5px; display: inline-block;"> <span style="margin-right: 5px;">1</span> <span style="font-size: 1.2em; font-weight: bold;">5 T</span> <span style="margin-left: 5px;">2</span> </div>

**Package Information**

Qty: 10k/Reel

**CONTACT INFORMATION**

No.1001, Shiwan (7) Road, Pudong District, Shanghai, P.R.China.201207

Tel: 86-21-68969993 Fax: 86-21-50757680 Email: [market@way-on.com](mailto:market@way-on.com)

WAYON website: <http://www.way-on.com>

For additional information, please contact your local Sales Representative.

**WAYON** ® is registered trademark of Wayon Corporation.

Specifications are subject to change without notice.  
The device characteristics and parameters in this data sheet can and do vary in different applications and actual device performance may vary over time.  
Users should verify actual device performance in their specific applications.

## X-ON Electronics

Largest Supplier of Electrical and Electronic Components

*Click to view similar products for [ESD Suppressors / TVS Diodes](#) category:*

*Click to view products by [Wayon](#) manufacturer:*

Other Similar products are found below :

[60KS200C](#) [D18V0L1B2LP-7B](#) [D5V0F4U5P5-7](#) [DESD5V0U1BB-7](#) [NTE4902](#) [P4KE27CA](#) [P6KE11CA](#) [P6KE39CA-TP](#) [P6KE8.2A](#)  
[SA110CA](#) [SA60CA](#) [SA64CA](#) [SMBJ12CATR](#) [SMBJ33CATR](#) [SMBJ8.0A](#) [ESD101-B1-02ELS E6327](#) [ESD105-B1-02EL E6327](#) [ESD112-B1-02EL E6327](#) [ESD119B1W01005E6327XTSA1](#) [ESD5V0L1B02VH6327XTSA1](#) [ESD7451N2T5G](#) [19180-510](#) [CPDT-5V0USP-HF](#)  
[3.0SMCJ33CA-F](#) [3.0SMCJ36A-F](#) [HSPC16701B02TP](#) [D3V3Q1B2DLP3-7](#) [D55V0M1B2WS-7](#) [DESD5V0U1BL-7B](#) [DRTR5V0U4SL-7](#)  
[SCM1293A-04SO](#) [ESD200-B1-CSP0201 E6327](#) [SM12-7](#) [SMF8.0A-TP](#) [SMLJ45CA-TP](#) [SMQA1000T1G](#) [CEN955 W/DATA](#) [82350120560](#)  
[VESD12A1A-HD1-GS08](#) [CPDUR5V0R-HF](#) [CPDQC5V0U-HF](#) [CPDQC5V0USP-HF](#) [CPDQC5V0-HF](#) [IP4042CX5/LF,135](#) [D1213A-01LP4-7B](#) [D1213A-02WL-7](#) [1SMB33CAT3G-XYZ](#) [MMAD1108/TR13](#) [5KP100A](#) [5KP15A](#)