

Features

- Way-on Small Signal MOSFETs
- $V_{DS} = 20V$, $I_D = 3.1A$
 $R_{DS(on)} < 45m\Omega @ V_{GS} = 4.5V$
 $R_{DS(on)} < 60m\Omega @ V_{GS} = 2.5V$
- Trench LV MOSFET Technology

Mechanical Characteristics

- SOT-23 Package
- Marking : Making Code
- RoHS Compliant

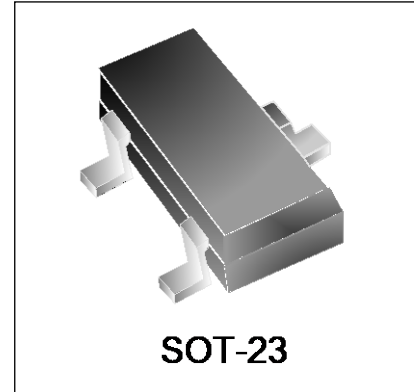

Schematic & PIN Configuration

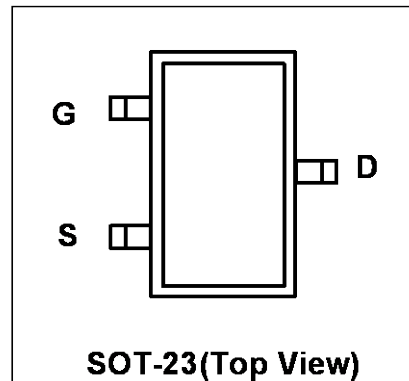
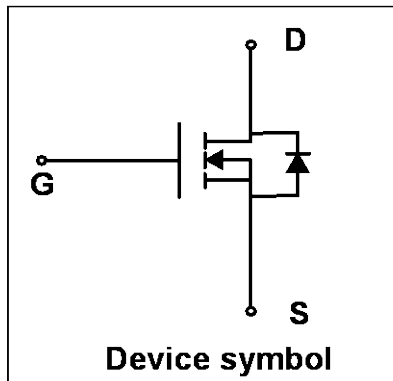

Absolute Maximum Rating ($T_A = 25^\circ C$ unless otherwise noted)

Parameter	Symbol	Value	Unit
Drain-Source Voltage	V_{DS}	20	V
Gate-Source Voltage	V_{GS}	± 8	V
Continuous Drain Current	I_D	3.1	A
$T_A = 25^\circ C$			
Pulsed Drain Current ¹	I_{DM}	12.4	A
Power Dissipation	P_D	700	mW
$T_A = 25^\circ C$			
Operating Junction and Storage Temperature Range	T_J, T_{STG}	-55 to 150	$^\circ C$

Thermal Characteristics

Parameter	Symbol	Value	Unit
Thermal Resistance from Junction to Ambient ²	$R_{\theta JA}$	179	$^\circ C/W$

Electrical Characteristics (T_J=25°C unless otherwise noted)

Parameter	Symbol	Test Condition	Min.	Typ.	Max.	Unit
Static Characteristics						
Drain-Source Breakdown Voltage	V_{(BR)DSS}	V _{GS} = 0 V, I _D = 250μA	20	-	-	V
Drain Cut-off Current	I_{DSS}	V _{DS} = 20V, V _{GS} = 0 V	-	-	1	μA
Gate Leakage Current	I_{GSS}	V _{GS} = ±8V, V _{DS} = 0 V	-	-	±100	nA
Gate Threshold Voltage	V_{GS(th)}	V _{GS} = V _{DS} , I _D = 250μA	0.4	0.75	1.2	V
Drain-Source on-State Resistance ³	R_{DS(on)}	V _{GS} = 4.5V, I _D = 3.1A	-	33	45	mΩ
		V _{GS} = 2.5V, I _D = 2.5A	-	43	60	
Dynamic Characteristics⁴						
Input Capacitance	C_{iss}	V _{GS} = 0V, V _{DS} = 10V, f = 1 MHz	-	300	-	pF
Output Capacitance	C_{oss}		-	54	-	
Reverse Transfer Capacitance	C_{rss}		-	43	-	
Switching Characteristics⁴						
Total Gate Charge	Q_g	V _{DS} = 10V, V _{GS} = 4.5V, I _D = 3A	-	2.9	-	nC
Gate-Source charge	Q_{gs}		-	0.4	-	
Gate-Drain Charge	Q_{gd}		-	0.6	-	
Turn-on Delay Time	t_{d(on)}	V _{GS} = 4.5V, V _{DS} = 10V, R _L = 3.3Ω, R _G = 6Ω	-	2.5	-	ns
Turn-on Rise Time	t_r		-	3.2	-	
Turn-off Delay Time	t_{d(off)}		-	21	-	
Turn-off Fall Time	t_f		-	3	-	
Source-Drain Diode characteristics						
Body Diode Voltage	V_{SD}	I _S = 1A, V _{GS} = 0V	-	-	1.2	V
Continuous Source Current	I_S		-	-	3.1	A

Notes:

1. Repetitive rating, pulse width limited by junction temperature T_{J(MAX)}=150°C
2. The data tested by surface mounted on a 1 inch² FR-4 board with 2OZ copper, The value in any given application depends on the user's specific board design.
3. Pulse Test: Pulse width≤300μs, duty cycle≤2%.
4. This value is guaranteed by design hence it is not included in the production test.

Typical Characteristics

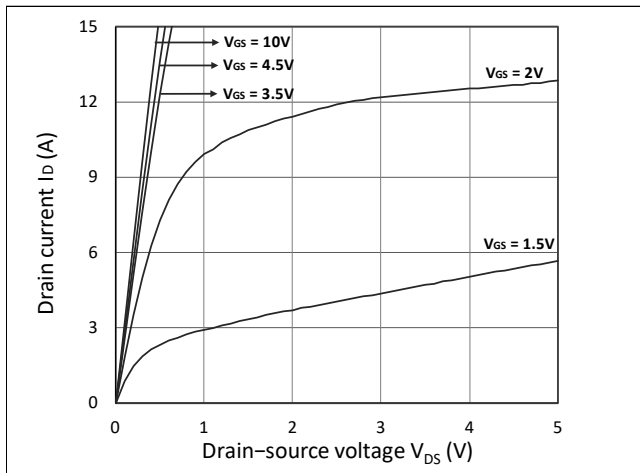

Figure 1. Output Characteristics

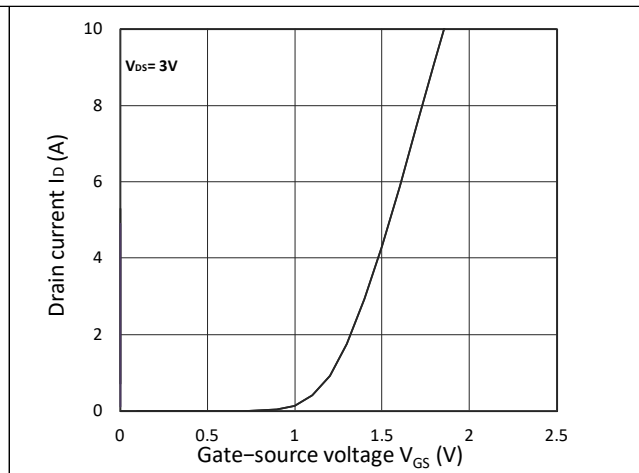

Figure 2. Transfer Characteristics

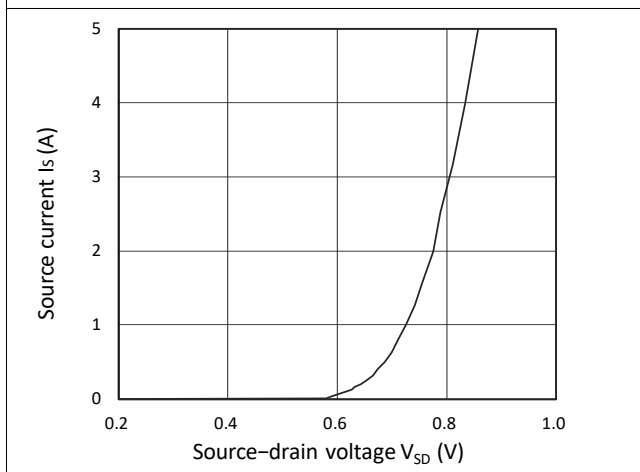

Figure 3. Forward Characteristics of Reverse

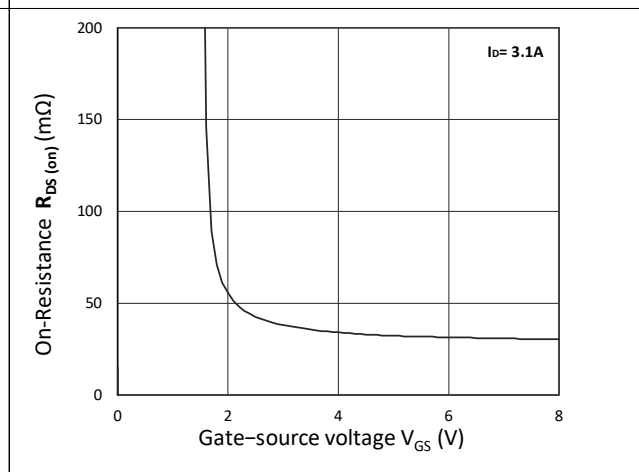

Figure 4. $R_{DS(on)}$ vs. V_{GS}

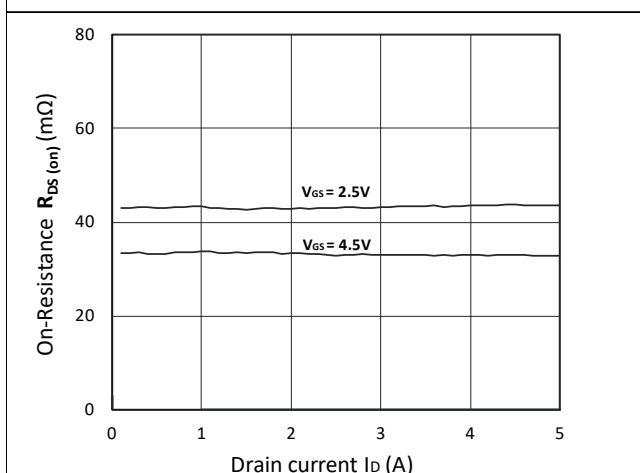

Figure 5. $R_{DS(on)}$ vs. I_D

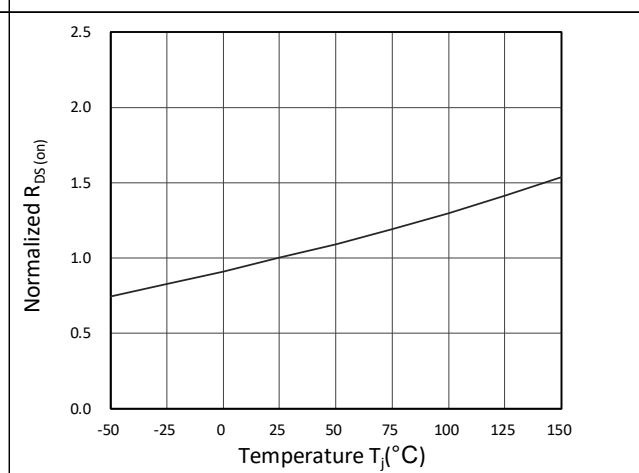
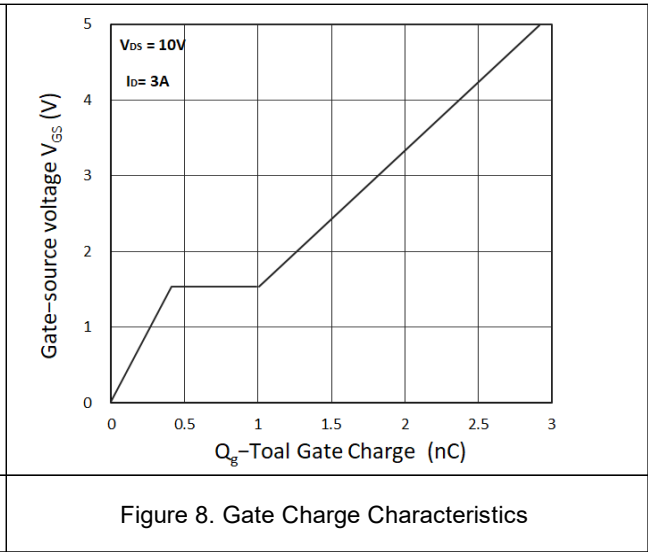
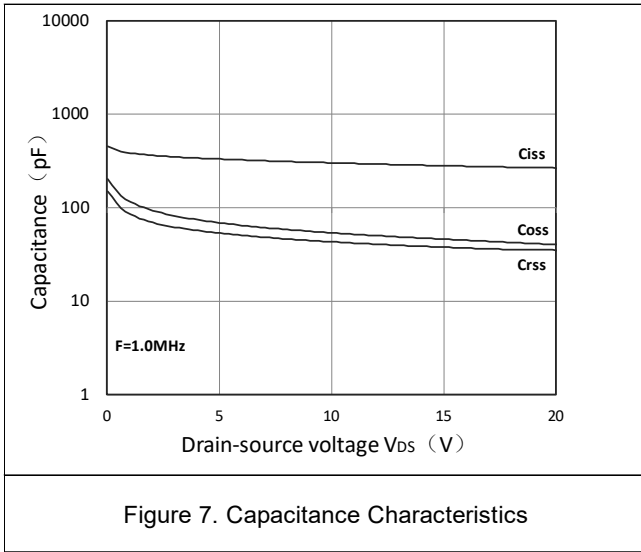
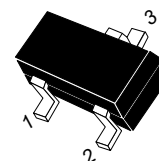
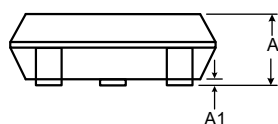
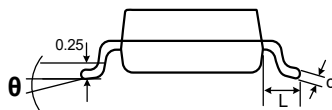
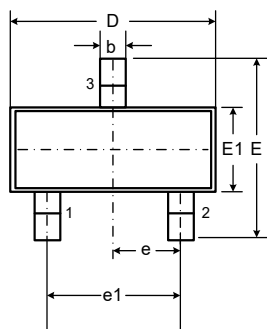

Figure 6. Normalized $R_{DS(on)}$ vs. Temperature



Outline Drawing – SOT-23

PACKAGE OUTLINE



SOT-23

DIMENSIONS

SYMBOL	MILLIMETER		INCHES	
	MIN	MAX	MIN	MAX
A	0.90	1.15	0.035	0.045
A1	0.00	0.10	0.000	0.004
b	0.30	0.50	0.012	0.020
c	0.08	0.15	0.003	0.006
D	2.80	3.00	0.110	0.118
E	2.25	2.55	0.089	0.100
E1	1.20	1.40	0.047	0.055
e	0.95 BSC		0.037BSC	
e1	1.80	2.00	0.071	0.079
L	0.55REF		0.022REF	
θ	0°	8°	0°	8°

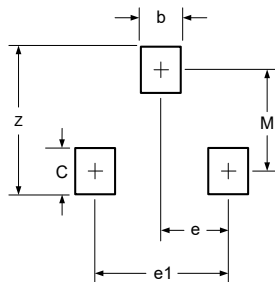

DIMENSIONS		
DIM	INCHES	MILLIMETERS
M	0.080	2.02
C	0.032	0.80
Z	0.111	2.82
e	0.037 BSC	0.95 BSC
e1	0.075 BSC	1.90 BSC
b	0.032	0.80

Notes

1. Dimensioning and tolerances per ANSI Y14.5M, 1985.
2. Controlling Dimension: Inches
3. Pin 3 is the cathode (Unidirectional Only).
4. Dimensions are exclusive of mold flash and metal burrs.

Marking Codes

Part Number	WM02N31M
Marking Code	

Package Information

Qty: 3k/Reel

CONTACT INFORMATION

No.1001, Shiwan (7) Road, Pudong District, Shanghai, P.R.China.201207

Tel: 86-21-68969993 Fax: 86-21-50757680 Email: market@way-on.comWAYON website: <http://www.way-on.com>

For additional information, please contact your local Sales Representative.



® is registered trademark of Wayon Corporation.

Specifications are subject to change without notice.

The device characteristics and parameters in this data sheet can and do vary in different applications and actual device performance may vary over time. Users should verify actual device performance in their specific applications.

X-ON Electronics

Largest Supplier of Electrical and Electronic Components

Click to view similar products for [MOSFET](#) category:

Click to view products by [Wayon](#) manufacturer:

Other Similar products are found below :

[614233C](#) [648584F](#) [IRFD120](#) [IRFF430](#) [JANTX2N5237](#) [2N7000](#) [FCA20N60_F109](#) [FDZ595PZ](#) [AOD464](#) [2SK2267\(Q\)](#) [2SK2545\(Q,T\)](#)
[405094E](#) [423220D](#) [MIC4420CM-TR](#) [VN1206L](#) [614234A](#) [715780A](#) [SSM6J414TU,LF\(T](#) [751625C](#) [PSMN4R2-30MLD](#)
[TK31J60W5,S1VQ\(O](#) [2SK2614\(TE16L1,Q\)](#) [DMN1017UCP3-7](#) [EFC2J004NUZTDG](#) [FCAB21350L1](#) [P85W28HP2F-7071](#) [DMN1053UCP4-7](#)
[NTE2384](#) [NTE2969](#) [NTE6400A](#) [DMN2080UCB4-7](#) [DMN61D9UWQ-13](#) [US6M2GTR](#) [DMN31D5UDJ-7](#) [SSM6P54TU,LF](#) [DMP22D4UFO-](#)
[7B](#) [IPS60R3K4CEAKMA1](#) [DMN1006UCA6-7](#) [DMN16M9UCA6-7](#) [STF5N65M6](#) [STU5N65M6](#) [C3M0021120D](#) [DMN13M9UCA6-7](#)
[BSS340NWH6327XTSA1](#) [MCM3400A-TP](#) [DMTH10H4M6SPS-13](#) [IRF40SC240ARMA1](#) [IPS60R1K0PFD7SAKMA1](#)
[IPS60R360PFD7SAKMA1](#) [IPS60R600PFD7SAKMA1](#)