

N-Channel Enhancement MOSFET

Features

- Way-on Small Signal MOSFETs
- $V_{DS} = 60V$, $I_D = 0.34A$
 $R_{DS(on)} < 2\Omega @ V_{GS} = 10V$
 $R_{DS(on)} < 2.5\Omega @ V_{GS} = 4.5V$
- Trench LV MOSFET Technology
- ESD Protected

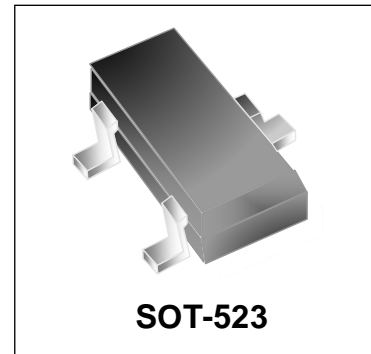

Mechanical Characteristics

- SOT-523 Package
- Marking : Making Code
- RoHS Compliant

Schematic & PIN Configuration

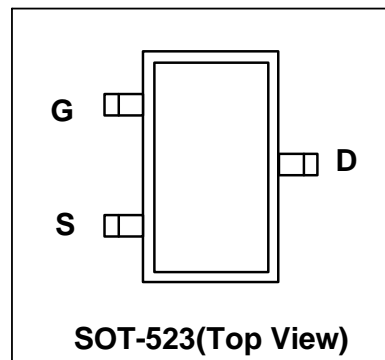
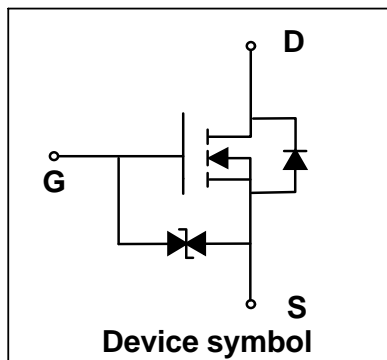

Absolute Maximum Rating ($T_A=25^\circ C$ unless otherwise noted)

Parameter	Symbol	Value	Unit
Drain-Source Voltage	V_{DS}	60	V
Gate-Source Voltage	V_{GS}	± 20	V
Continuous Drain Current	I_D	0.34	A
Pulsed Drain Current ¹	I_{DM}	1.36	A
Power Dissipation	P_D	300	mW
Operating Junction and Storage Temperature Range	T_J, T_{STG}	-55 to 150	$^\circ C$

Thermal Characteristics

Parameter	Symbol	Value	Unit
Thermal Resistance from Junction to Ambient ²	$R_{\theta JA}$	420	$^\circ C/W$

Electrical Characteristics (T_J=25°C unless otherwise noted)

Parameter	Symbol	Test Condition	Min.	Typ.	Max.	Unit
Static Characteristics						
Drain-Source Breakdown Voltage	V _{(BR)DSS}	V _{GS} = 0V, I _D = 250μA	60	-	-	V
Gate leakage Current	I _{GSS}	V _{GS} = ±20V, V _{DS} = 0V	-	-	±10	μA
Drain Cut-off Current	I _{DSS}	V _{DS} = 60V, V _{GS} = 0V	-	-	1	μA
Gate Threshold Voltage	V _{GS(th)}	V _{DS} = V _{GS} , I _D = 250μA	1	1.4	2	V
Drain-Source On-state Resistance ³	R _{DS(on)}	V _{GS} = 10V, I _D = 0.3A	-	1.3	2	Ω
		V _{GS} = 4.5V, I _D = 0.2A	-	1.4	2.5	Ω
Dynamic characteristics⁴						
Input Capacitance	C _{iss}	V _{DS} = 30V, V _{GS} = 0V, f = 1MHz	-	25	-	pF
Output Capacitance	C _{oss}		-	5.6	-	
Reverse Transfer Capacitance	C _{rss}		-	2.2	-	
Switching Characteristics⁴						
Total Gate Charge	Q _g	V _{GS} = 10V, V _{DS} = 30V, I _D = 0.3A	-	1.06	-	nC
Gate-Source Charge	Q _{gs}		-	0.27	-	
Gate-Drain Charge	Q _{gd}		-	0.23	-	
Turn-on Delay Time	t _{d(on)}	V _{GS} = 10V, V _{DD} = 30V, I _D = 0.3A, R _G = 3Ω	-	4.3	-	ns
Turn-on Rise Time	t _r		-	2.4	-	
Turn-off Delay Time	t _{d(off)}		-	21	-	
Turn- off Fall Time	t _f		-	14.5	-	
Source-Drain Diode characteristics						
Diode Forward Voltage ³	V _{SD}	I _S = 0.3A , V _{GS} =0V,	-	-	1.5	V
Continuous Source Current	I _S	-	-	-	0.34	A

Notes:

1. Repetitive rating, pulse width limited by junction temperature T_{J(MAX)}=150°C.
2. The data tested by surface mounted on a 1 inch² FR-4 board with 2OZ copper, The value in any given application depends on the user's specific board design.
3. Pulse Test: Pulse width≤300μs, duty cycle≤2%.
4. This value is guaranteed by design hence it is not included in the production test.

Typical Characteristics

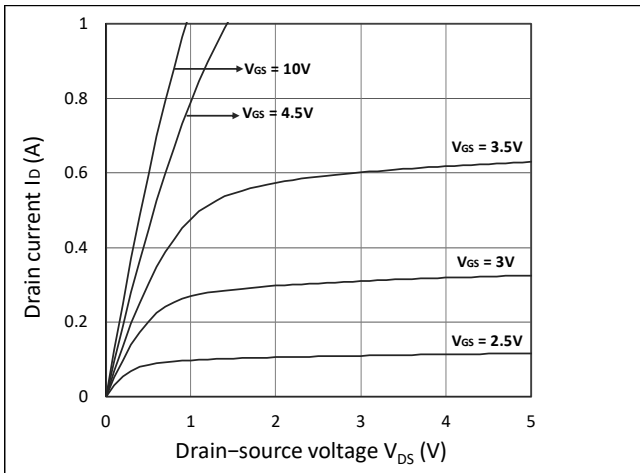

Figure 1. Output Characteristics

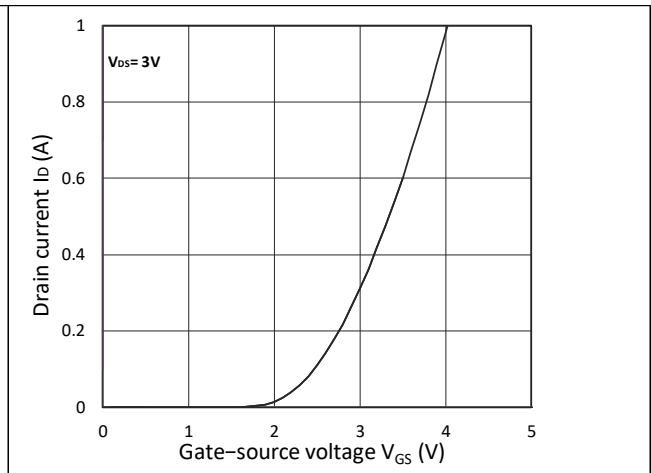

Figure 2. Transfer Characteristics

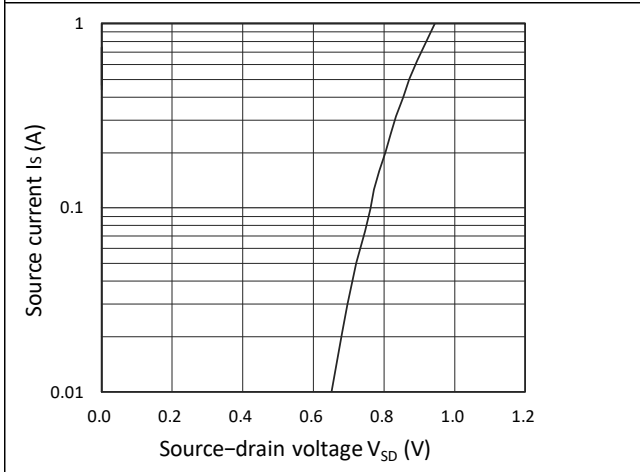

Figure 3. Forward Characteristics of Reverse

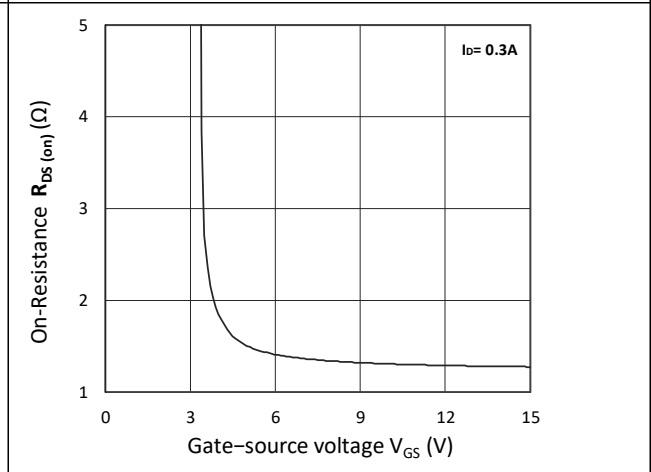

Figure 4. $R_{DS(ON)}$ vs. V_{GS}

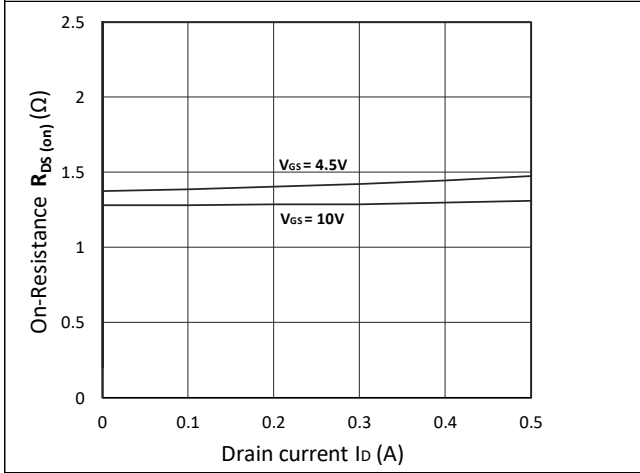

Figure 5. $R_{DS(ON)}$ vs. I_D

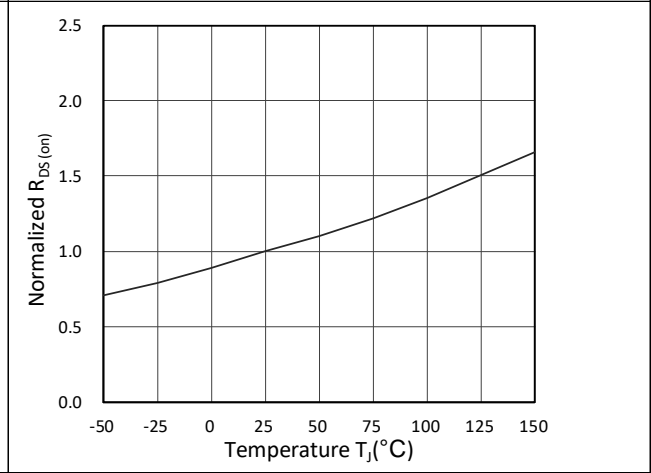

Figure 6. Normalized $R_{DS(ON)}$ vs. Temperature

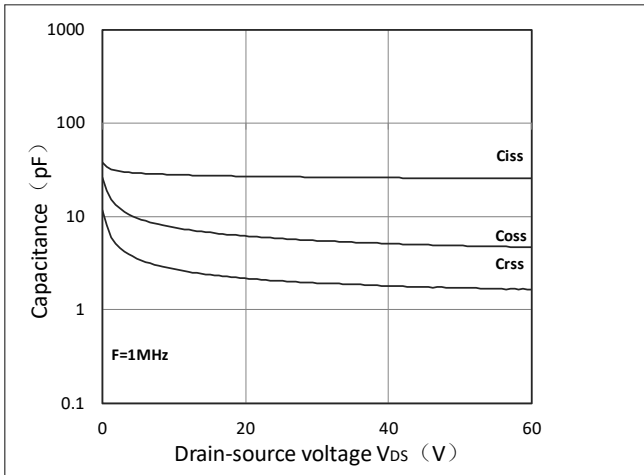

Figure 7. Capacitance Characteristics

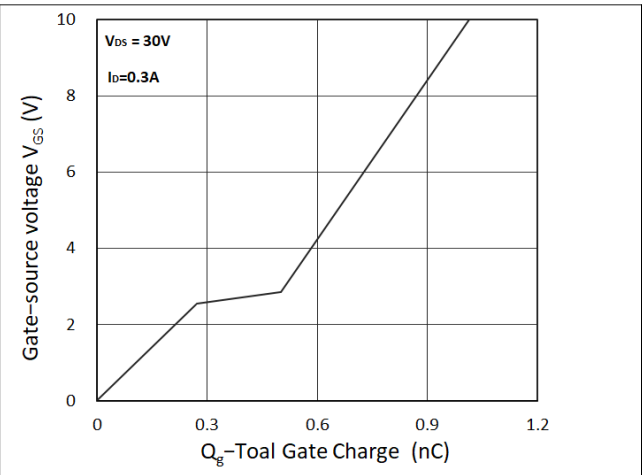
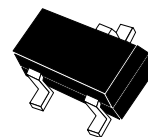
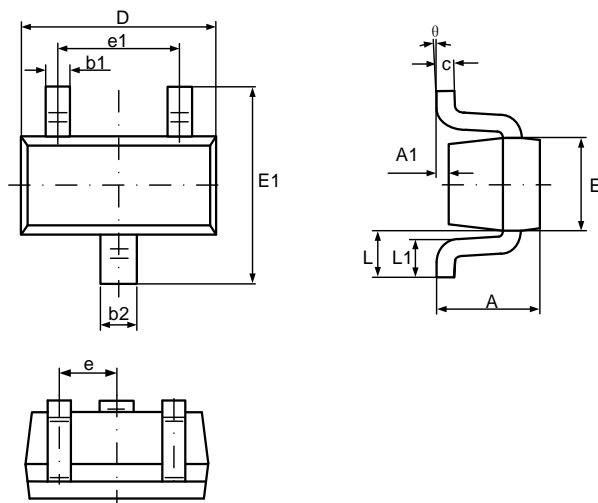

Figure 8. Gate Charge Characteristics

Outline Drawing – SOT-523

PACKAGE OUTLINE



SOT-523

DIMENSIONS

SYMBOL	MILLIMETER		INCHES	
	MIN	MAX	MIN	MAX
A	0.70	0.90	0.028	0.035
A1	0.00	0.10	0.000	0.004
b1	0.15	0.25	0.006	0.010
b2	0.25	0.35	0.010	0.014
c	0.10	0.20	0.004	0.008
D	1.50	1.70	0.059	0.067
E	0.70	0.90	0.028	0.035
E1	1.45	1.75	0.057	0.069
e1	0.90	1.10	0.035	0.043
e	0.45	0.55	0.018	0.022
L	0.30	0.50	0.012	0.020
L1	0.26	0.46	0.01	0.018
θ	0	8°	0	8°

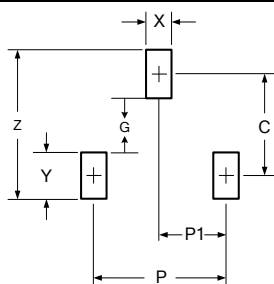

DIMENSIONS		
DIM	INCHES	MILLIMETERS
C	0.055	1.40
P	0.039	1.00
P1	0.020	0.50
G	0.024	0.60
X	0.016	0.40
Y	0.031	0.80
Z	0.087	2.20

Notes

1. Dimensioning and tolerances per ANSI Y14.5M, 1985.
2. Controlling Dimension: Inches
3. Pin 3 is the cathode (Unidirectional Only).
4. Dimensions are exclusive of mold flash and metal burrs.

Marking Codes

Part Number	WM06N03LE
Marking Code	

Package Information

Qty: 3k/Reel

CONTACT INFORMATION

No.1001, Shiwan (7) Road, Pudong District, Shanghai, P.R.China.201207

Tel: 86-21-68969993 Fax: 86-21-50757680 Email: market@way-on.comWAYON website: <http://www.way-on.com>

For additional information, please contact your local Sales Representative.

® is registered trademark of Wayon Corporation.

Specifications are subject to change without notice.

The device characteristics and parameters in this data sheet can and do vary in different applications and actual device performance may vary over time. Users should verify actual device performance in their specific applications.

X-ON Electronics

Largest Supplier of Electrical and Electronic Components

Click to view similar products for [MOSFET](#) category:

Click to view products by [Wayon](#) manufacturer:

Other Similar products are found below :

[IRFD120](#) [JANTX2N5237](#) [BUK455-60A/B](#) [MIC4420CM-TR](#) [VN1206L](#) [NDP4060](#) [SI4482DY](#) [IPS70R2K0CEAKMA1](#) [SQD23N06-31L-GE3](#)
[TK16J60W,S1VQ\(O](#) [2SK2614\(TE16L1,Q\)](#) [DMN1017UCP3-7](#) [DMN1053UCP4-7](#) [SQJ469EP-T1-GE3](#) [NTE2384](#) [DMC2700UDMQ-7](#)
[DMN2080UCB4-7](#) [DMN61D9UWQ-13](#) [US6M2GTR](#) [DMN31D5UDJ-7](#) [DMP22D4UFO-7B](#) [DMN1006UCA6-7](#) [DMN16M9UCA6-7](#)
[STF5N65M6](#) [IRF40H233XTMA1](#) [STU5N65M6](#) [DMN6022SSD-13](#) [DMN13M9UCA6-7](#) [DMTH10H4M6SPS-13](#) [DMN2990UFB-7B](#)
[IPB80P04P405ATMA2](#) [2N7002W-G](#) [MCAC30N06Y-TP](#) [MCQ7328-TP](#) [NTMC083NP10M5L](#) [NVMFS2D3P04M8LT1G](#) [BXP7N65D](#)
[BXP4N65F](#) [AOL1454G](#) [WMJ80N60C4](#) [BXP2N20L](#) [BXP2N65D](#) [BXT1150N10J](#) [BXT1700P06M](#) [TSM60NB380CP](#) [ROG](#) [RQ7L055BGTCR](#)
[DMNH15H110SK3-13](#) [SLF10N65ABV2](#) [BSO203SP](#) [BSO211P](#)