

# HSF

Recommended P.C.B Layout(Top Side)  
(PCB BOARD TOLERANCE±0.05)

**NOTES:**

Current Rating: 3.0AMP  
 Contact Resistance: 20mΩ Max  
 Withstand Voltage: 1000V AC/DC  
 Insulation Resistance: 1000MΩ Min  
 Operation Temperature: -40°C to +105°C

Contact Material:Brass  
 Contact plating:Au Or Sn over Ni  
 Insulator Material:PBT+30%G.F UL94V-0 

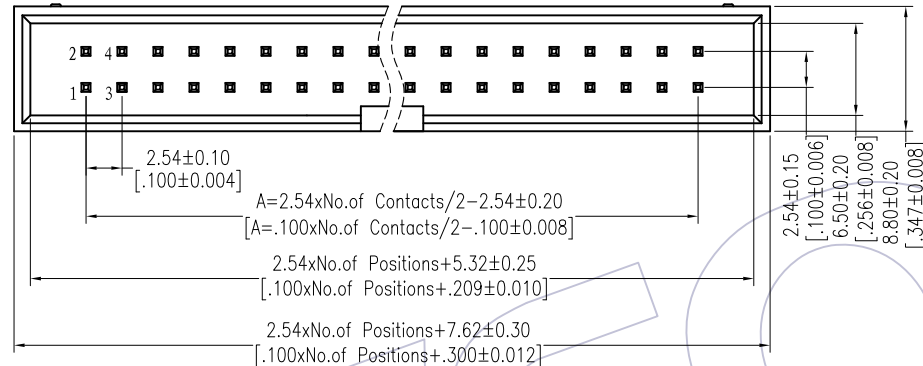
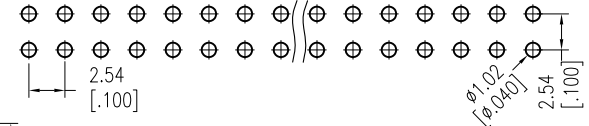

## Ordering Information

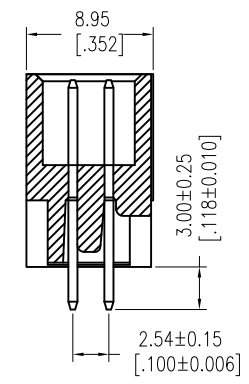
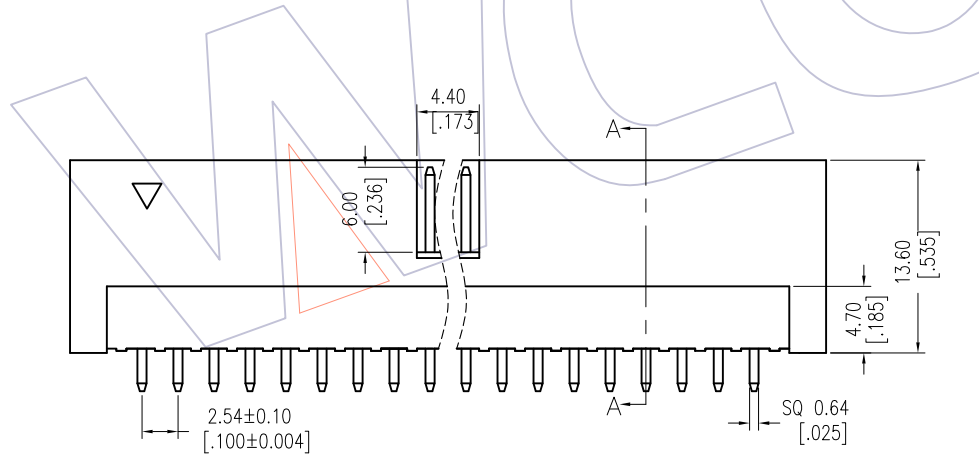

3112-XX S XX B K00 X 1

No.of Pins	Contact Plating	Color Insulator	Packing:
10P 30P 14P 34P 16P 40P 20P 50P 24P 60P 26P 64P	G0=Gold Flash G3=10u"Gold G4=15u"Gold G5=30u"Gold S0=Gold Flash/Tin S3=10u"Gold/Tin S4=15u"Gold/Tin S5=30u"Gold/Tin SN=Tin	B=Black U=blue G=Gray(427C) E=Gray(413C)	A=Tray T=Tube



A(TOLERANCE)

ITEM	≤20P	>20P
A	±0.20	±0.30

				OPERATION	DRAW	DATE	SCALE	FIT	PART NO.
				x.X ±0.40	Allen	2014/05/05	UNIT	mm	3112-XXSXXBK00XX
A1	2014/05/05	MODIFY		x.XX ±0.25	CHECK	DATE	SIZE	A4	TITLE:
AO	2012/09/25	NEW	-----	x.XXX ±0.15	APPROVE	DATE	SHEET	1/1	2.54 BOX HEADER 180° H=13.6
REV	DATE	MODIFICATION DESCRIPTION	CHANGE	Angle ± 3'			PROJ.		Customer NO.
				DIM TOL					

# WCON

Http: www.wcon.com

WCON-Dongguan Tel: +86 769 85358920 Fax: +86 769 85358915 E-mail: sales@wcon.com	WCON-Kunshan Tel: +86 512 57468408 Fax: +86 512 57468468 E-mail: salesks@wcon.com
---	--

## X-ON Electronics

Largest Supplier of Electrical and Electronic Components

*Click to view similar products for [I/O Connectors](#) category:*

*Click to view products by [Wcon](#) manufacturer:*

Other Similar products are found below :

[571763P](#) [61-168618-12P](#) [D20419-211](#) [72.250.1628.2](#) [72.250.2428.2](#) [76.350.0729.0](#) [76871-1403](#) [PCR-E36PM](#) [PCS-XE26LKA](#) [PCS-XES68MS+](#) [G38A71314B](#) [9776-18-6](#) [1571250010](#) [157-22500-3](#) [MS3471L14-19P L/C](#) [192991-0703](#) [91-644626-35P](#) [172501-6002](#) [FCN-260C008-A/L0](#) [FCN-260C024-AL0](#) [FCN-261Z008](#) [2000314-1](#) [200331-1](#) [PCS-E28FS+](#) [PCS-XE26SLFD+](#) [PCS-XE26SLFDT+](#) [G730VID08BDC24](#) [HDMR-29-01-S-SM-TR](#) [HDRA-E68W1LFDTC-SL+](#) [54182-0605](#) [UE86K842720321](#) [38113800006](#) [DP3AR020WQ1R200](#) [Z4.102.0680.0](#) [500-1040](#) [500-1052](#) [500-1054](#) [ZP-4008-66L](#) [10-565995-597N](#) [10-584459-12P](#) [5554841-1](#) [SM3106F14S-7S-LC](#) [SM3106R18-18S](#) [U90B3054061110](#) [U65-E04-4020](#) [ZPF000000000097891](#) [557-262M2-06C](#) [PCS-96LFD+](#) [60-042222-02S](#) [10099439-003C-TRLF](#)