

HSF

NOTES:
 Current Rating:1A AMP
 Contact Resistance:30milliohm Max
 Withstand Voltage:250V AC/DC
 Insulation Resistance:1000Megohm Min
 Operation Temperature:-40°C to +105°C

Housing Material:PA9T+30%GF(UL94V-0)
 Contact Material:Copper alloy
 Contact plating:Au or Sn over Ni Plating

Ordering Information

3135-XX R XX B K00 X 1

| No. of Pins | Contact Plating | Color Insulator | Packing |
|-------------|-------------------|-----------------|---------|
| 4 8 | G0=Gold Flash | B=Black | A=Type |
| 6 34 | G3=10u"Gold | U=Blue | T=Tube |
| 10 40 | G4=15u"Gold | W=White | |
| 14 44 | G5=30u"Gold | | |
| 16 50 | S0=Gold Flash/Tin | | |
| 20 60 | S3=10u"Gold/Tin | | |
| 24 64 | S4=15u"Gold/Tin | | |
| 26 80 | S5=30u"Gold/Tin | | |
| 30 100 | SN=Tin | | |
| 32 | | | |

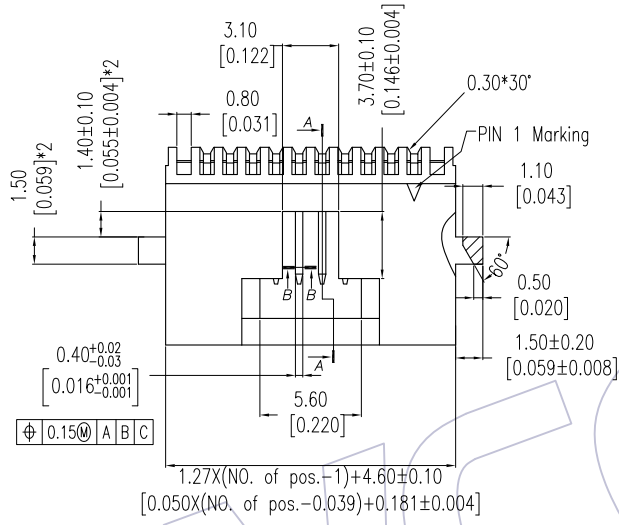

Recommended P.C.B Layout (Top Side)
 (PCB BOARD TOLERANCE ± 0.05)

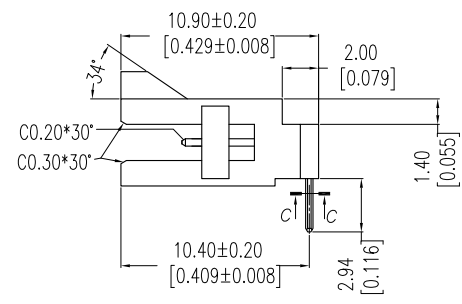
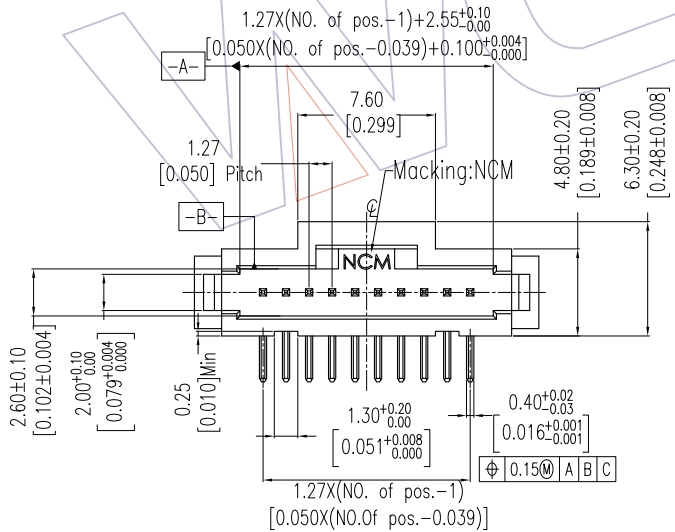
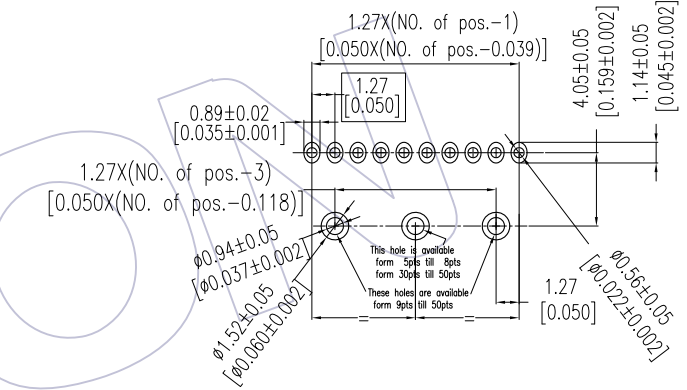

| REV | DATE | MODIFICATION DESCRIPTION | CHANGE | OPERATION | | DRAW | DATE | SCALE | FIT | PART NO. | TITLE: | WCON | |
|-----|------------|--------------------------|--------|-----------|-------|---------|------------|-------|-----|------------------------|--|--------------------------|--|
| | | | | Angle | TOL | | | | | | | Http: www.wcon.com | |
| A2 | 2015/01/20 | MODIFY | △ | X.X | ±0.40 | Allen | 2015/01/20 | UNIT | mm | 3135-XXRXXBK00X1 | 1.27mm Box 90° DIP (Without fixing) | WCON-Dongguan | |
| A1 | 2012/07/16 | MODIFY | △ | X.XX | ±0.25 | CHECK | DATE | SIZE | A4 | | | WCON-Kunshan | |
| A0 | 2011/11/18 | NEW | — | X.XXX | ±0.15 | APPROVE | DATE | SHEET | 1/2 | Tel: +86 769 85358920 | | Tel: +86 512 57468408 | |
| REV | DATE | MODIFICATION DESCRIPTION | CHANGE | DIM | TOL | | DATE | PROJ. | ◆ | Customer NO. | K4021 | Tel: +86 769 85358915 | |
| | | | | | | | | | | E-mail: sales@wcon.com | | E-mail: salesks@wcon.com | |

WCON
 Http: www.wcon.com

WCON-Dongguan
 Tel: +86 769 85358920
 Fax: +86 769 85358915
 E-mail: sales@wcon.com

WCON-Kunshan
 Tel: +86 512 57468408
 Fax: +86 512 57468468
 E-mail: salesks@wcon.com

HSF

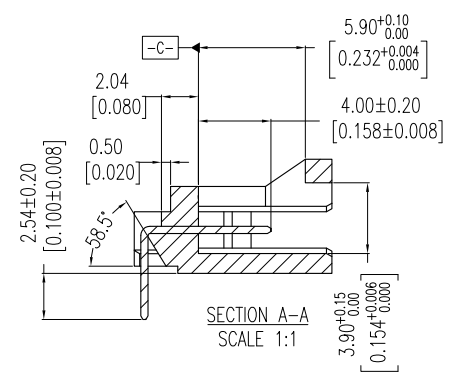
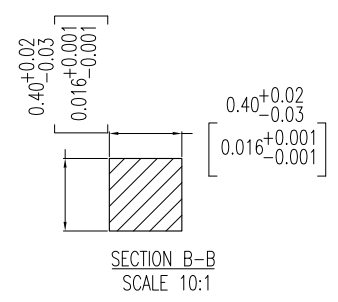
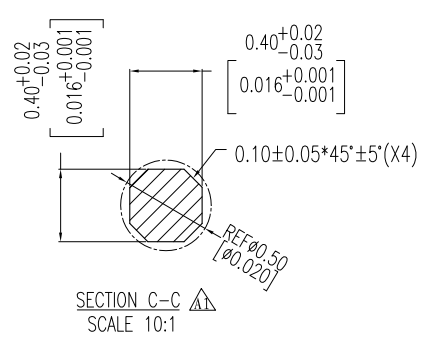
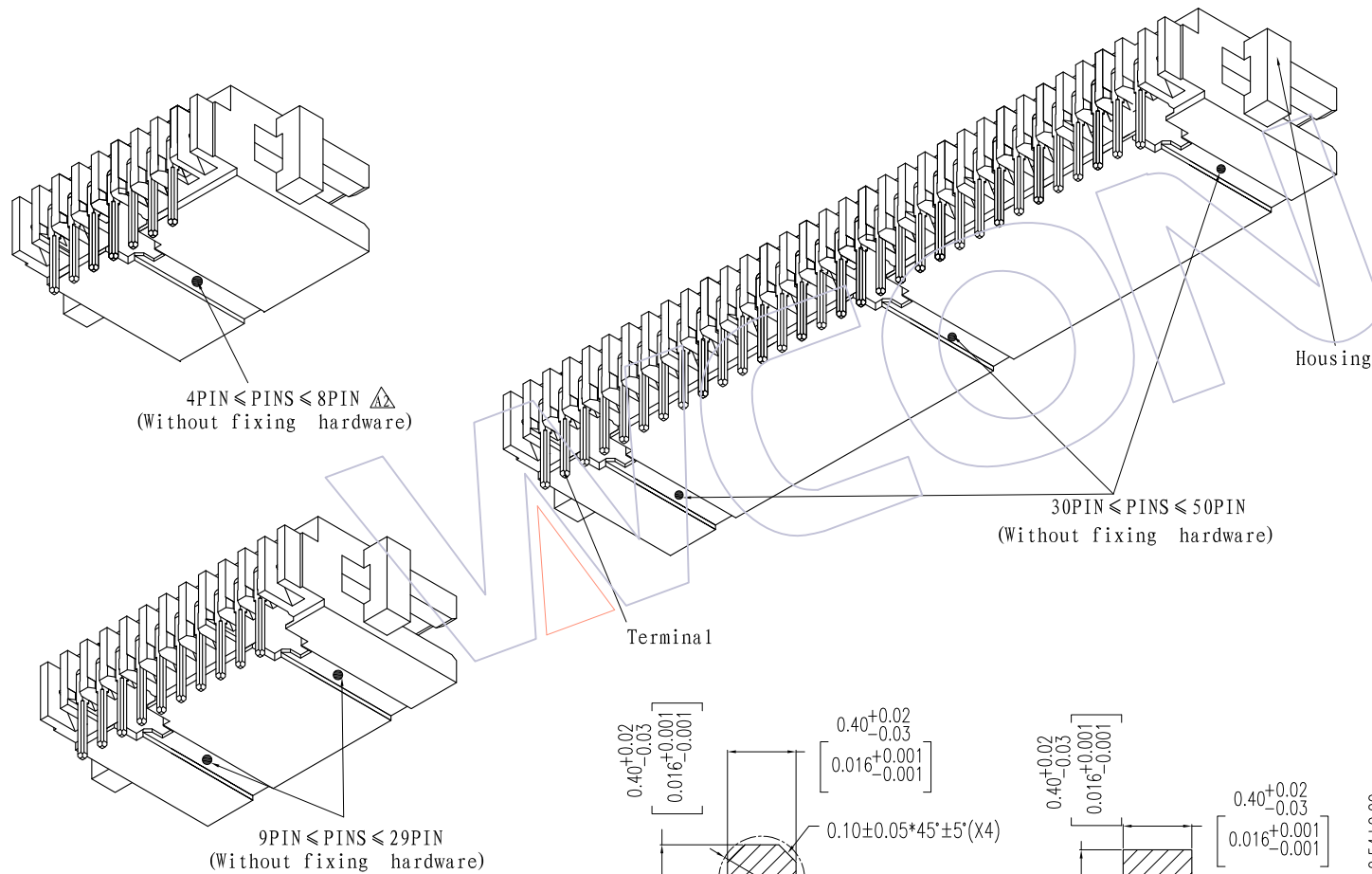

| REV | DATE | MODIFICATION DESCRIPTION | CHANGE | OPERATION | DRAW | DATE | SCALE | FIT | PART NO. |
|-----|------------|--------------------------|--------|-------------|---------|------------|-------|--------|--|
| A2 | 2015/01/20 | MODIFY | △ | X.X ±0.40 | Allen | 2015/01/20 | UNIT | mm | 3135-XXRXXBK00X1 |
| A1 | 2012/07/16 | MODIFY | △ | X.XX ±0.25 | CHECK | DATE | inch | TITLE: | |
| A0 | 2011/11/18 | NEW | — | X.XXX ±0.15 | APPROVE | DATE | SHEET | A4 | 1.27mm Box 90° DIP (Without fixing) |
| | | | | Angle ± 3' | | | 2/2 | | Customer NO. K4021 |
| | | | | DIM TOL | | | PROJ. | | |

WCON
Http: www.wcon.com

WCON-Dongguan Tel: +86 769 85358920 Fax: +86 769 85358915 E-mail: sales@wcon.com

WCON-Kunshan Tel: +86 512 57468408 Fax: +86 512 57468468 E-mail: salesks@wcon.com

X-ON Electronics

Largest Supplier of Electrical and Electronic Components

Click to view similar products for [I/O Connectors](#) category:

Click to view products by [Wcon](#) manufacturer:

Other Similar products are found below :

[571763P](#) [61-168618-12P](#) [D20419-211](#) [72.250.1628.2](#) [72.250.2428.2](#) [76.350.0729.0](#) [76871-1403](#) [PCR-E36PM](#) [PCS-XE26LKA](#) [PCS-XES68MS+](#) [G38A71314B](#) [9776-18-6](#) [1571250010](#) [157-22500-3](#) [MS3471L14-19P L/C](#) [192991-0703](#) [91-644626-35P](#) [172501-6002](#) [FCN-260C008-A/L0](#) [FCN-260C024-AL0](#) [FCN-261Z008](#) [2000314-1](#) [200331-1](#) [PCS-E28FS+](#) [PCS-XE26SLFD+](#) [PCS-XE26SLFDT+](#) [G730VID08BDC24](#) [HDMR-29-01-S-SM-TR](#) [HDRA-E68W1LFDTC-SL+](#) [54182-0605](#) [UE86K842720321](#) [38113800006](#) [DP3AR020WQ1R200](#) [Z4.102.0680.0](#) [500-1040](#) [500-1052](#) [500-1054](#) [ZP-4008-66L](#) [10-565995-597N](#) [10-584459-12P](#) [5554841-1](#) [SM3106F14S-7S-LC](#) [SM3106R18-18S](#) [U90B3054061110](#) [U65-E04-4020](#) [ZPF000000000097891](#) [557-262M2-06C](#) [PCS-96LFD+](#) [60-042222-02S](#) [10099439-003C-TRLF](#)