

HSF

NOTES:

Current Rating: 3.0AMP
 Contact Resistance: 20mΩ Max
 Withstand Voltage: 1000V AC/DC $\Delta 2$
 Insulation Resistance: 1000MΩ Min
 Operation Temperature: -40℃ to +105℃

Contact Material: Brass $\Delta 1$
 Contact plating: Au Or Sn over Ni
 Insulator Material: PBT Or PA9T+30%G.F UL94V-0

06P-18P Without Slot "A" and "B"
 20P-58P Without Slot "A", With Slot "B"
 60P-64P With Slot "A" and "B"

Ordering Information

3210 - XX S XX X X X 1

No. of Pins	Contact Plating	Insulator Color	Latch Type	Packing
06 24	G0=Gold Flash	B=Black	L=Long Latch	A=Tray
08 26	G3=10u"Gold	G=Grey(427C)	S=Short Latch	T=Tube
10 30	G4=15u"Gold		N=Without Latch	
12 34	G5=30u"Gold			
14 40	S0=Gold Flash/Tin			
16 50	S3=10u"Gold/Tin			
18 60	S4=15u"Gold/Tin			
20 64	S5=30u"Gold/Tin			
	SN=Tin			

	Pin Length	DIM.A
Standard	16.0	3.30
Alternate	17.3	4.50

Item	Pitch	Mating
Standard	2.54	5211
Alternate		

REV	DATE	MODIFICATION DESCRIPTION	CHANGE	OPERATION	DRAW	DATE	SCALE	FIT	PART NO.
A4	2019/01/04	MODIFY	$\Delta 4$	x.x	Ding	2019/01/04	UNIT	mm	3210-XXSXXXXX1
A3	2014/12/03	MODIFY	$\Delta 3$	x.xx	CHECK	DATE	SHEET	A4	TITLE:
A2	2013/02/25	MODIFY	$\Delta 2$	x.xxx	APPROVE	DATE	PROJ.	1/1	2.54 EJECTOR HEADER 180° DIP
A0	2012/12/06	NEW	----	Angle					Customer NO.
				DIM					

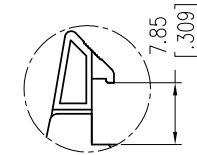
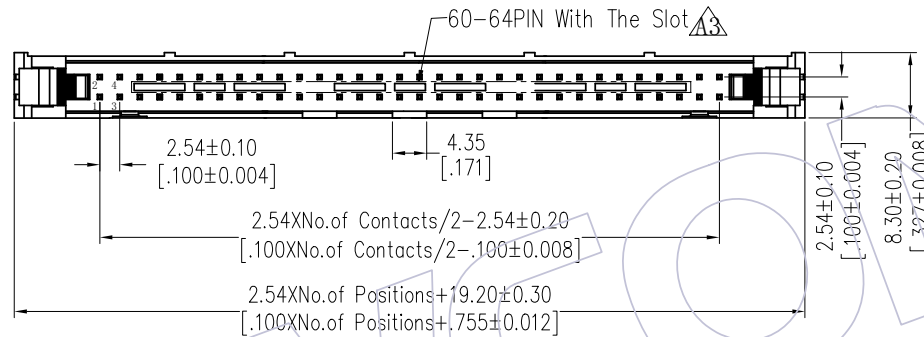
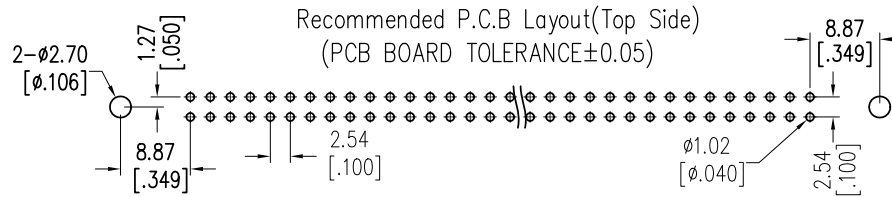

Long Latch

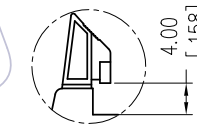

Short Latch

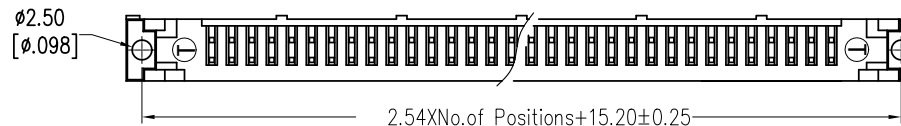
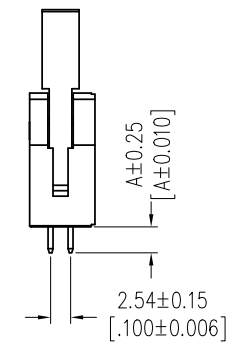
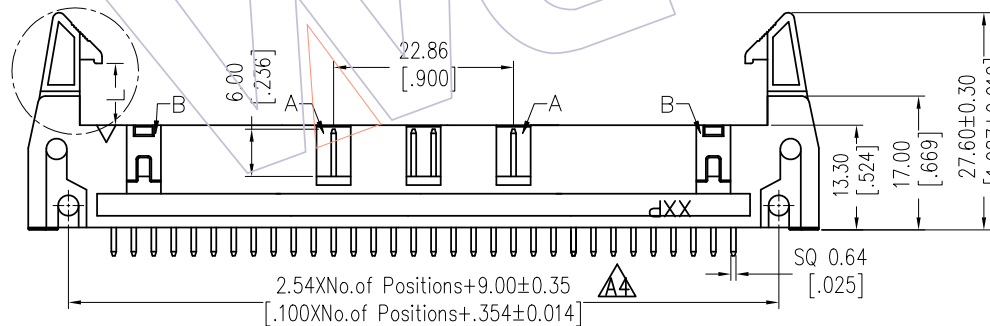

WCON

Http: www.wcon.com

WCON-Dongguan Tel: +86 769 85358920 Fax: +86 769 85358915 E-mail: sales@wcon.com
 WCON-Kunshan Tel: +86 512 57468408 Fax: +86 512 57468468 E-mail: salesks@wcon.com

X-ON Electronics

Largest Supplier of Electrical and Electronic Components

Click to view similar products for [I/O Connectors](#) category:

Click to view products by [Wcon](#) manufacturer:

Other Similar products are found below :

[571763P](#) [D20419-211](#) [72.250.1628.2](#) [72.250.2428.2](#) [76.350.0729.0](#) [76871-1403](#) [PCR-E36PM](#) [PCS-XE26LKA](#) [PCS-XES68MS+](#)
[G38A71314B](#) [9776-18-6](#) [1571250010](#) [157-22500-3](#) [MS3471L14-19P L/C](#) [192991-0703](#) [91-644626-35P](#) [172501-6002](#) [FCN-260C008-A/L0](#)
[FCN-260C024-AL0](#) [FCN-261Z008](#) [2000314-1](#) [200331-1](#) [PCS-E28FS+](#) [PCS-XE26SLFD+](#) [PCS-XE26SLFDT+](#) [G730VID08BDC24](#) [HDMR-](#)
[29-01-S-SM-TR](#) [HDRA-E68W1LFDTC-SL+](#) [HDR-E14MSG1+](#) [54182-0605](#) [UE86K842720321](#) [38113800006](#) [DP3AR020WQ1R200](#)
[Z4.102.0680.0](#) [500-1040](#) [500-1052](#) [500-1054](#) [ZP-4008-66L](#) [10-565995-597N](#) [10-584459-12P](#) [5554841-1](#) [SM3106F14S-7S-LC](#)
[U90B3054061110](#) [U65-E04-4020](#) [ZPF000000000097891](#) [557-262M2-06C](#) [PCS-96LFD+](#) [60-042222-02S](#) [10099439-003C-TRLF](#) [226-0348-](#)
[000](#)