

HSF

NOTES:
 Current Rating:0.5AMP
 Contact Resistance:30mΩ max
 Withstand Voltage:100V AC/DC
 Insulation Resistance:500MΩ min
 Operation Temperature:-40°C to +125°C

Contact Material:Phosphor Bronze
 Cap Material:SUS,t=0.25mm
 Housing Material:LCP(UL94V-0),Nature
 Contact plating:Au and Tin over Ni

Flatness: <80Pins The "M" Is 0.12mm MAX
 ≥80Pins The "M" Is 0.15mm MAX

Ordering Information

3616-P XXX - XXX XX R 01

No.of Pins Housing High Contact Plating R=Tape&Reel+CAP
 Male=H1 S1=3u"Gold/Tin S3=10u"Gold/Tin

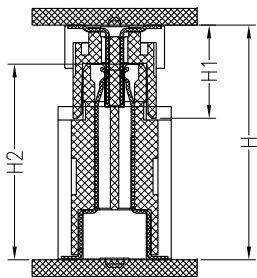

Assembly

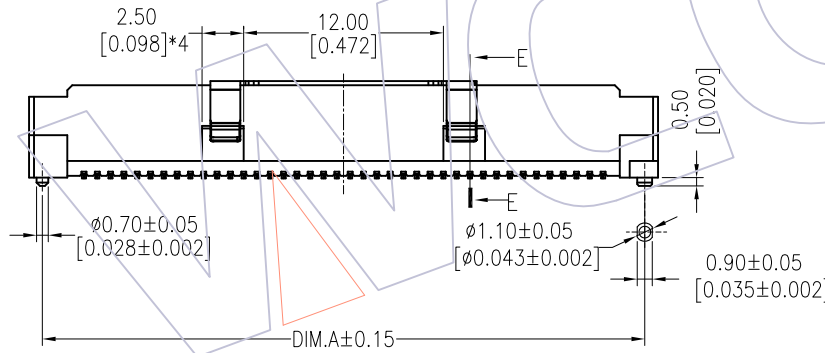
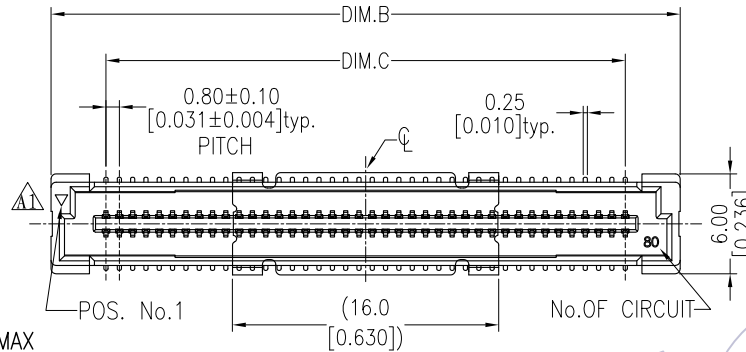

Recommended P. C. B Layout (Top Side)
 (PCB BOARD TOLERANCE ± 0.05)

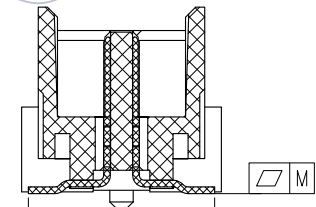
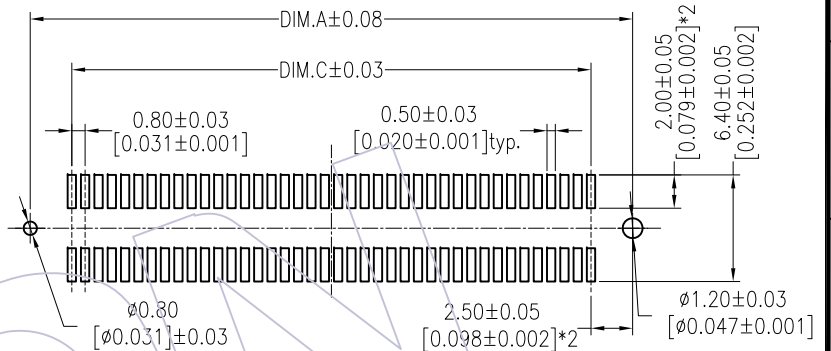

SECTION E-E
 SCALE 2:1

PART NO.	DIM.K (MALE HEIGHT)	ASS'Y HEIGHT (H)	PLUG (H1)	SOCKET (H2)	ASS'Y HEIGHT (H)	PLUG (H1)	SOCKET (H2)	ASS'Y HEIGHT (H)	PLUG (H1)	SOCKET (H2)
3616-PXXX-046XXR01	4.60	5.00	4.60	3.75	9.00	4.60	7.75	13.00	4.60	11.75
3616-PXXX-056XXR01	5.60	6.00	5.60	3.75	10.00	5.60	7.75	14.00	5.60	11.75
3616-PXXX-066XXR01	6.60	7.00	6.60	3.75	11.00	6.60	7.75	15.00	6.60	11.75
3616-PXXX-076XXR01	7.60	8.00	7.60	3.75	12.00	7.60	7.75	16.00	7.60	11.75

79.20	85.80	84.20	200
71.20	77.80	76.20	180
63.20	69.80	68.20	160
55.20	61.80	60.20	140
47.20	53.80	52.20	120
39.20	45.80	44.20	100
31.20	37.80	36.20	80
23.20	29.80	28.20	60
15.20	21.80	20.20	40
DIM.C	DIM.B	DIM.A	PIN NO.

REV	DATE	MODIFICATION DESCRIPTION	CHANGE	OPERATION	DRAW	DATE	SCALE	FIT	PART NO.
A2	2014/11/07	Modify	△	X.X ±0.40	Allen	2014/11/07	UNIT mm		3616-PXXX-XXXXXR01
A1	2014/08/21	Modify	△	X.XX ±0.25	CHECK	DATE	SIZE A4		TITLE: 0.80mm B TO B
A0	2013/04/22	NEW	—	X.XXX ±0.15	APPROVE	DATE	SHEET 1/2		"T" MALE 180° SMT TYPE
				Angle ± 3'			PROJ.		Customer NO.

WCON

Http: www.wcon.com

WCON-Dongguan WCON-Kunshan
 Tel: +86 769 85358920 Tel: +86 512 57468408
 Fax: +86 769 85358915 Fax: +86 512 57468468
 E-mail: sales@wcon.com E-mail: salesks@wcon.com

HSF

PLUG

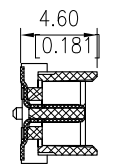

3616-PXXX-046XXR01

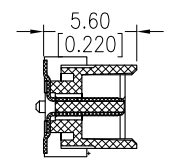

3616-PXXX-056XXR01

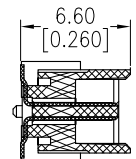

3616-PXXX-066XXR01

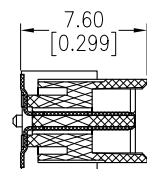

3616-PXXX-076XXR01

RECEPTACLE

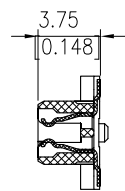

3616-SXXX-037XXR01

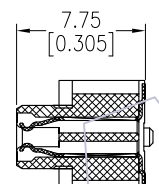

3616-SXXX-077XXR01

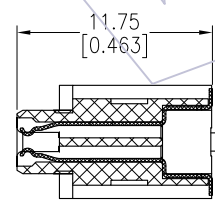

3616-SXXX-117XXR01

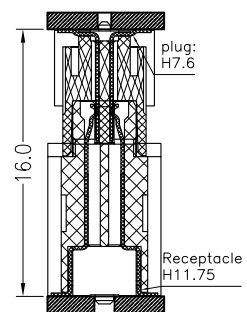
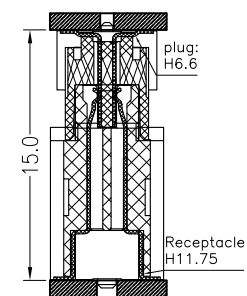
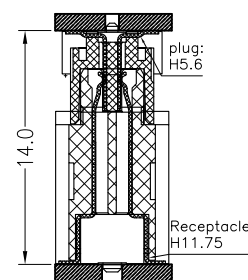
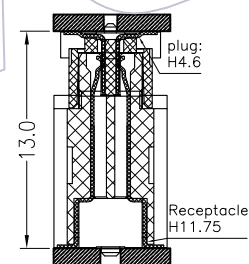
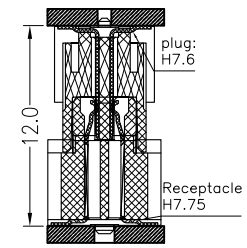
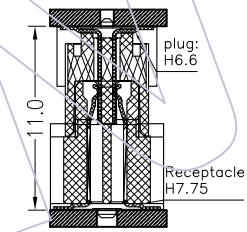
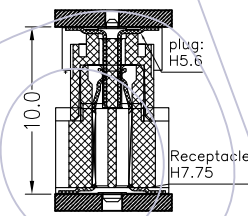
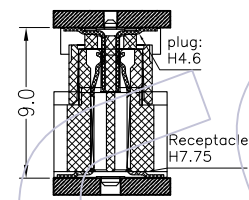
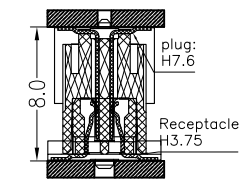
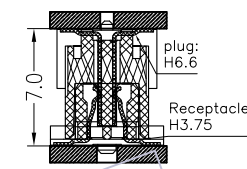
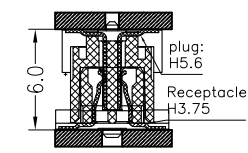
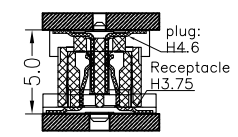

REV	DATE	MODIFICATION DESCRIPTION	CHANGE	OPERATION	DRAW	DATE	SCALE	FIT	PART NO.
A2	2014/11/07	Modify		X.X	Allen	2014/11/07	UNIT	mm	3616-PXXX-XXXXXR01
A1	2014/08/21	Modify		X.XX	CHECK	DATE	inch	SIZE	
A0	2013/04/22	NEW	—	X.XXX	APPROVE	DATE	SHEET	2/2	TITLE: 0.80mm B TO B "T" MALE 180° SMT TYPE
				Angle			PROJ.		Customer NO.
				DIM					
				TOL					

WCON
Http: www.wcon.com

WCON-Dongguan Tel: +86 769 85358920 Fax: +86 769 85358915 E-mail: sales@wcon.com
WCON-Kunshan Tel: +86 512 57468408 Fax: +86 512 57468468 E-mail: salesks@wcon.com

X-ON Electronics

Largest Supplier of Electrical and Electronic Components

Click to view similar products for [Board to Board & Mezzanine Connectors](#) category:

Click to view products by [Wcon](#) manufacturer:

Other Similar products are found below :

[589158040000018](#) [MDF7C-18P-2.54DSA\(55\)](#) [FCN-268F036-G/BD](#) [FCN-268M012-G/0D](#) [FCN-268M024-G/1D](#) [FCN-723J004/1](#) [MIS-048-01-F-D-DP-K](#) [832-10-034-10-001000](#) [FX4C-80S-1.27DSA](#) [93696-330](#) [224393](#) [FCN-235D050-G/C](#) [210-93-314-41-105000](#) [2-22603-0](#) [MDF7-40DP-2.54DSA\(55\)](#) [5031084030](#) [MIT-114-03-F-D-K](#) [55323-1519](#) [45970-4130](#) [YFT-20-05-H-03-SB-K](#) [503308-3040](#) [026-6203-PDB](#) [027-6203-PDB](#) [069159702701000](#) [101A10019X](#) [105061100000861+](#) [55650-0588-C](#) [75140-7012](#) [87471-650](#) [YTW-30-07-H-Q-410-140](#) [YTT-112-01-H-Q](#) [063209](#) [FCN-268F024-G0D](#) [10124054-515LF](#) [68685-603](#) [8-1616154-3](#) [MIS-019-01-F-D](#) [YTQ-12103HQ](#) [541371078](#) [IL-WX-10PB-HF-B-E1000E](#) [YFT-50-05-H-10-SB-K](#) [FCN-268M024-G/3D](#) [FCN-214J100-G/0](#) [FCN-230C068-E/S](#) [AXE812124](#) [74220-001](#) [354184](#) [P50-028-DDS-TG](#) [53309-2471](#) [54546-2071](#)