

# HSF

NOTES:  
 Current Rating: 0.5AMP  
 Voltage Rating: 50V AC/DC  
 Contact Resistance: 30mΩ max  
 Withstand Voltage: 100V AC for 1minute  
 Insulation Resistance: 500MΩ min  
 Operation Temperature: -25°C to +105°C

Housing Material: PA9T(UL94V-0), NATURAL  
 Contact Material: Copper alloy  
 Fixing Material: Copper alloy  
 Contact plating: Au over Ni  
 Fixing plating: Sn over Ni

## Ordering Information

3622-S XXX - XXX XX X 02

No. of Pins	Housing High	Contact Plating	T=Tube
14P 36P	022=2.20	G1=3u"Gold	P=Tube+CAP
20P 40P	027=2.70	G3=10u"Gold	R=Tape&Reel+CAP
24P 50P	048=4.80	G4=15u"Gold	
30P 60P		G5=30u"Gold	
32P		H5=30u"Gold(Contact area, 3u"Gold other area)	

ASS'Y HEIGHT(K)	PLUG(H2)	SOCKET(H1)
3.00	2.33	2.20
3.50	2.80	
4.00	2.80	
4.50	3.33	2.73
5.00	3.83	
5.50	4.33	
6.00	4.83	
6.50	3.33	
7.00	3.83	
7.50	4.33	4.70
8.00	4.83	

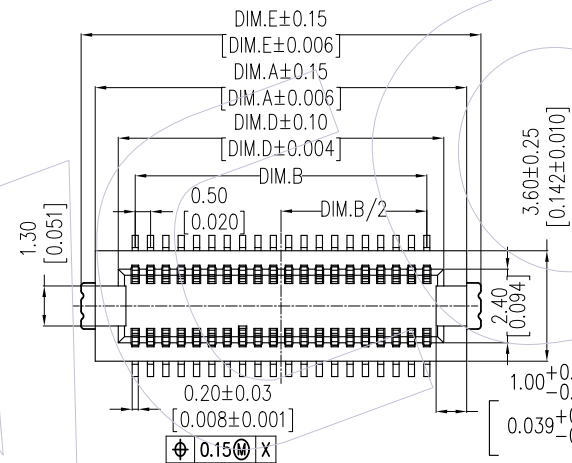
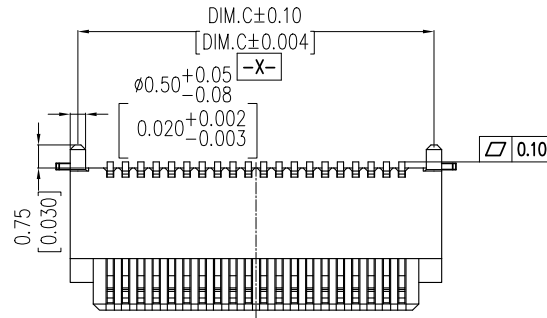
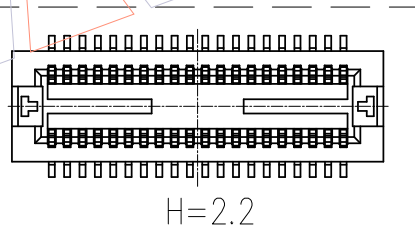

Recommended P.C.B Layout (Top Side)  
 (PCB BOARD TOLERANCE ± 0.05)

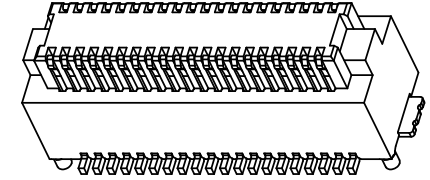
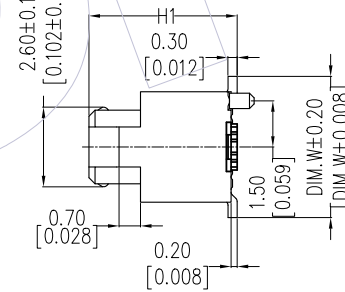
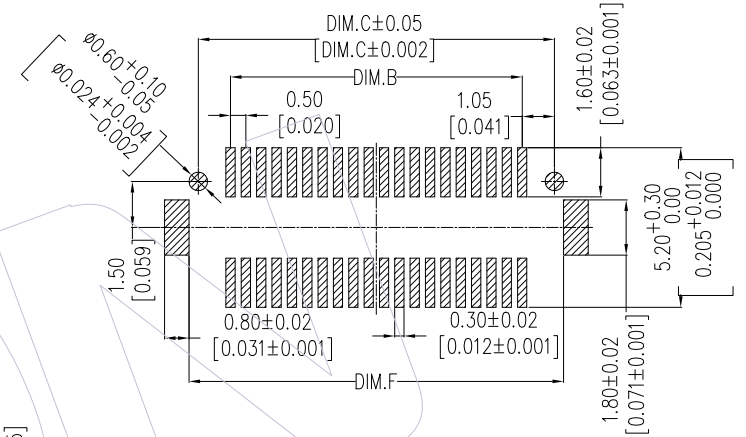

PART NO.	DIM.H1	DIM.W
3622-SXXX-022XXX02	2.20	
3622-SXXX-027XXX02	2.73	4.60
3622-SXXX-048XXX02	4.70	

PIN NO.	DIM.A	DIM.B	DIM.C	DIM.D	DIM.E	DIM.F
14	5.60	3.00	5.10	4.10	6.50	5.70
20	7.10	4.50	6.60	5.60	8.00	7.20
24	8.10	5.50	7.60	6.60	9.00	8.20
30	9.60	7.00	9.10	8.10	10.50	9.70
32	10.10	7.50	9.60	8.60	11.00	10.20
36	11.10	8.50	10.60	9.60	12.00	11.20
40	12.10	9.50	11.60	10.60	13.00	12.20
50	14.60	12.00	14.10	13.10	15.50	14.70
60	17.10	14.50	16.60	15.60	18.00	17.20

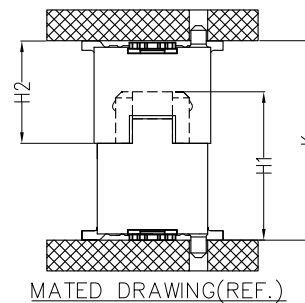

OPERATION	DRAW	DATE	SCALE	Fit	PART NO.
x.x ± 0.40	Ding	2018/03/09	UNIT	mm	3622-SXXX-XXXXXX02
x.xx ± 0.25	CHECK	DATE	SIZE	A4	TITLE:
x.xxx ± 0.15			SHEET	1/1	0.50pitch BTB FEMALE SMT TYPE
Angle ± 3'	APPROVE	DATE	PROJ.		W/ LATCH
DIM TOL					Customer NO.

# WCON

Http: www.wcon.com

WCON-Dongguan Tel: +86 769 85358920 Fax: +86 769 85358915 E-mail: sales@wcon.com	WCON-Kunshan Tel: +86 512 57468408 Fax: +86 512 57468468 E-mail: salesks@wcon.com
---	--

REV	DATE	MODIFICATION DESCRIPTION	CHANGE
AO	2018/03/09	NEW	-----

## X-ON Electronics

Largest Supplier of Electrical and Electronic Components

*Click to view similar products for [Board to Board & Mezzanine Connectors](#) category:*

*Click to view products by [Wcon](#) manufacturer:*

Other Similar products are found below :

[10135583-642402LF](#) [89885-310LF](#) [589158040000018](#) [6-1393048-0](#) [68683-613](#) [MDF7-12DP-2.54DSA](#) [MDF7-18P-2.54DSA\(01\)](#) [MDF7-20DP-2.54DSA](#) [MDF7-26D-2.54DSA\(55\)](#) [MDF7-3P-2.54DSA\(01\)](#) [MDF7B-20P-2.54DSA\(01\)](#) [MDF7B-3P-2.54DSA\(55\)](#) [MDF7C-11P-2.54DSA\(55\)](#) [MDF7C-18P-2.54DSA\(55\)](#) [MDF7C-5P-2.54DSA\(01\)](#) [MDF7P-5P-2.54DSA\(55\)](#) [75234-0516](#) [FCN-230C068-11](#) [FCN-268F012-G/BD](#) [FCN-268F036-G/BD](#) [FCN-268M012-G/0D](#) [FCN-268M024-G/1D](#) [FCN-360C008-C](#) [FCN-360C040-C](#) [FCN-723J004/1](#) [MIS-048-01-F-D-DP-K](#) [832-10-034-10-001000](#) [93696-325LF](#) [11828-1FA](#) [AXK630345P](#) [18097-0013](#) [ICA-328STT](#) [2007042-2](#) [304400-2](#) [FCN-214Q030-G/0](#) [FCN-215Q040-G/0](#) [FCN-230C068-ESA](#) [FCN-234P048-G/0](#) [FCN-235D050-G/C](#) [FCN-360A3](#) [FCN-360C040-B](#) [210-93-314-41-105000](#) [2-22603-0](#) [379-064-521-202](#) [MDF7-12P-2.54DSA\(01\)](#) [MDF7-16P-2.54DS\(56\)](#) [MDF7-40DP-2.54DSA\(55\)](#) [MDF7-8P-2.54DSA\(55\)](#) [MDF7B-16P-2.54DSA\(55\)](#) [AXG720047](#)