

HSF

NOTES:
 Current Rating: 3.0AMP
 Contact Resistance: 20mΩ Max
 Withstand Voltage: 1000V AC/DC
 Insulation Resistance: 1000MΩ Min
 Operation Temperature: -40°C to +105°C

Contact Material: Brass Δ
 Contact plating: Au over Ni
 Insulator Material: PBT+30%G.F UL94V-0
 10~16Pin Without "A"

Ordering Information

3810-XX XX W X N 0 X

No. of Pins	Contact Plating	Insulator Colour	Logo
10 30	S0=Gold Flash/Ni	G=Gray(427C)	
14 34	S3=10u"Gold/Ni	E=Gray(413C)	
16 40	S4=15u"Gold/Ni	B=Black	N=Without Logo
20 50	S5=30u"Gold/Ni		W=With Logo
24 60			
26 64			

Item	Pitch	Mating
Standard	2.54	5212/5211
Alternate		

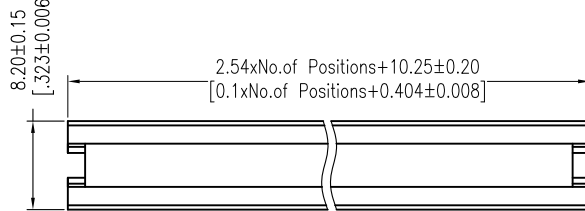
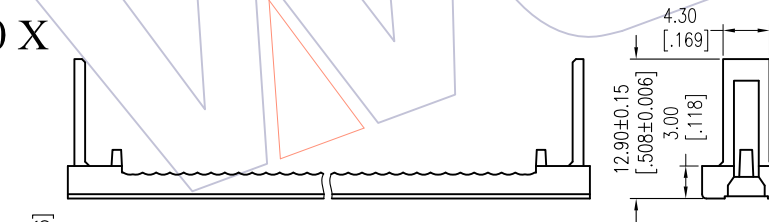
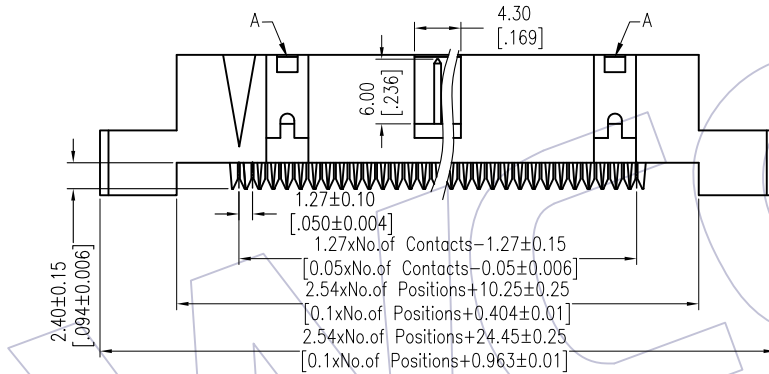
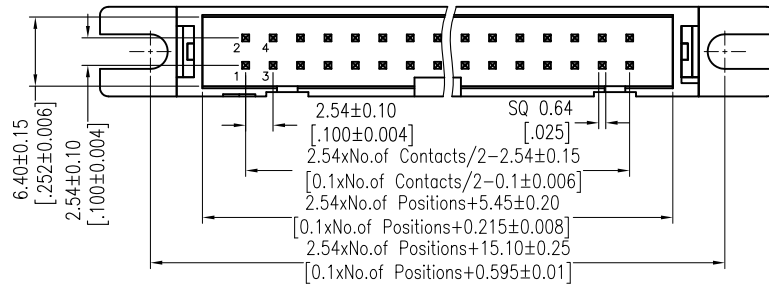

COVER P/N: G3810-XXXXC01 Δ

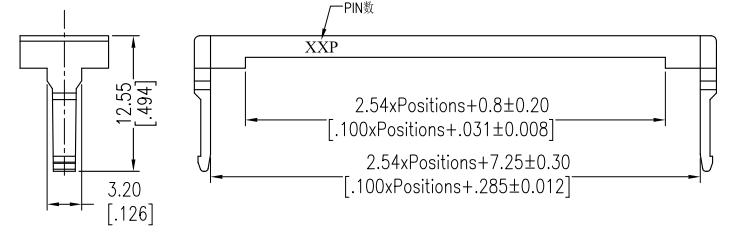
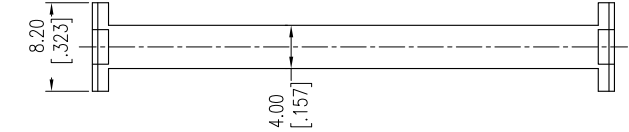
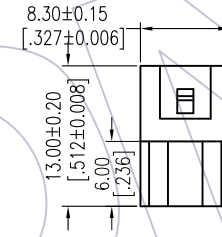

SR P/N: G3810-XXXXD01 Δ

REV	DATE	MODIFICATION DESCRIPTION	CHANGE	DIM	TOL	OPERATION	DRAW	DATE	SCALE	FIT	PART NO.
A3	2018/01/11	MODIFY	-----			OPERATION	DRAW	2018/01/11	UNIT	mm	3810-XXXXWXNOX
A2	2012/12/24	MODIFY THE NOTES: Phosphor Bronze → Brass	-----	x.X	±0.40		Ding		SIZE	A4	TITLE: 2.54mm BOX HEADER IDC TYPE 带定位孔
A1	2012/11/22	Modify The Contact Plating	-----	x.XX	±0.25		CHECK		SHEET	1/1	Customer NO.
A0	2012/09/25	NEW	-----	x.XXX	±0.15				PROJ.		
				Angle	± 3'		APPROVE				

WCON
 Http: www.wcon.com

WCON-Dongguan
 Tel: +86 769 85358920
 Fax: +86 769 85358915
 E-mail: sales@wcon.com

WCON-Kunshan
 Tel: +86 512 57468408
 Fax: +86 512 57468468
 E-mail: salesks@wcon.com

X-ON Electronics

Largest Supplier of Electrical and Electronic Components

Click to view similar products for [I/O Connectors](#) category:

Click to view products by [Wcon](#) manufacturer:

Other Similar products are found below :

[571763P](#) [61-168618-12P](#) [D20419-211](#) [72.250.1628.2](#) [72.250.2428.2](#) [76.350.0729.0](#) [76871-1403](#) [PCR-E36PM](#) [PCS-XE26LKA](#) [PCS-XES68MS+](#) [G38A71314B](#) [9776-18-6](#) [1571250010](#) [157-22500-3](#) [MS3471L14-19P L/C](#) [192991-0703](#) [91-644626-35P](#) [172501-6002](#) [FCN-260C008-A/L0](#) [FCN-260C024-AL0](#) [FCN-261Z008](#) [2000314-1](#) [200331-1](#) [PCS-E28FS+](#) [PCS-XE26SLFD+](#) [PCS-XE26SLFDT+](#) [G730VID08BDC24](#) [HDMR-29-01-S-SM-TR](#) [HDRA-E68W1LFDTC-SL+](#) [54182-0605](#) [UE86K842720321](#) [38113800006](#) [DP3AR020WQ1R200](#) [Z4.102.0680.0](#) [500-1040](#) [500-1052](#) [500-1054](#) [ZP-4008-66L](#) [10-565995-597N](#) [10-584459-12P](#) [5554841-1](#) [SM3106F14S-7S-LC](#) [U90B3054061110](#) [U65-E04-4020](#) [ZPF000000000097891](#) [557-262M2-06C](#) [PCS-96LFD+](#) [60-042222-02S](#) [10099439-003C-TRLF](#) [226-0348-000](#)