

HSF

NOTES:
 Rated Current: 1.0AMP
 Contact Resistance: 30mΩ max
 Withstand Voltage: 500V AC/DC
 Insulation Resistance: 1000MΩ min
 Operation Temperature: -40℃ to +105℃

Contact Material: Phosphor Bronze
 Contact Plating: Au Over Ni
 Insulator Material: PBT+30%G.F UL94V-0

Ordering Information

5226 - XX YP XX B W 01

- Two Parts Conn+Cover
- No. of Pins 6P-50P
- Contact Plating
 G0=Gold Flash
 G3=10u"Gold
 G4=15u"Gold
 G5=30u"Gold
 S0=Gold Flash/Ni
 S3=10u"Gold/Ni
 S4=15u"Gold/Ni
 S5=30u"Gold/Ni
- Color Insulator
 B=Black
 G=Grey(427C)

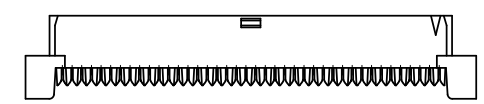
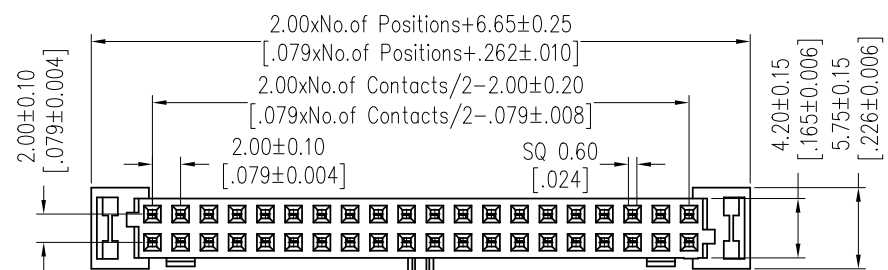

SINGLE RAMP LOCKING ONLY
 (APPLICABLE FOR 6 TO 12 CKT)

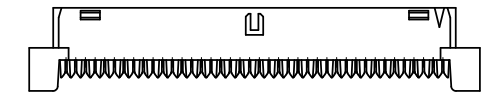

POLARIZATION AND RAMP LOCKING
 (APPLICABLE FOR 14 TO 50 CKT)

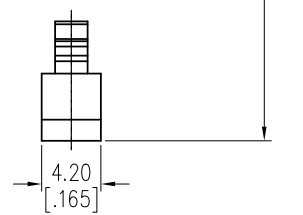
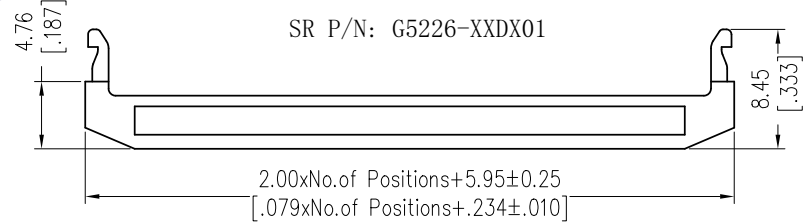
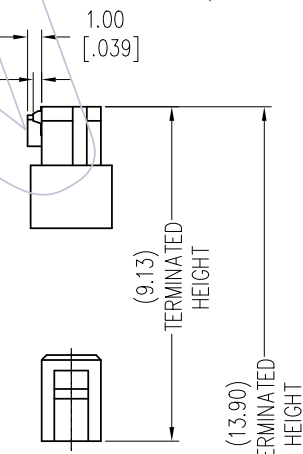
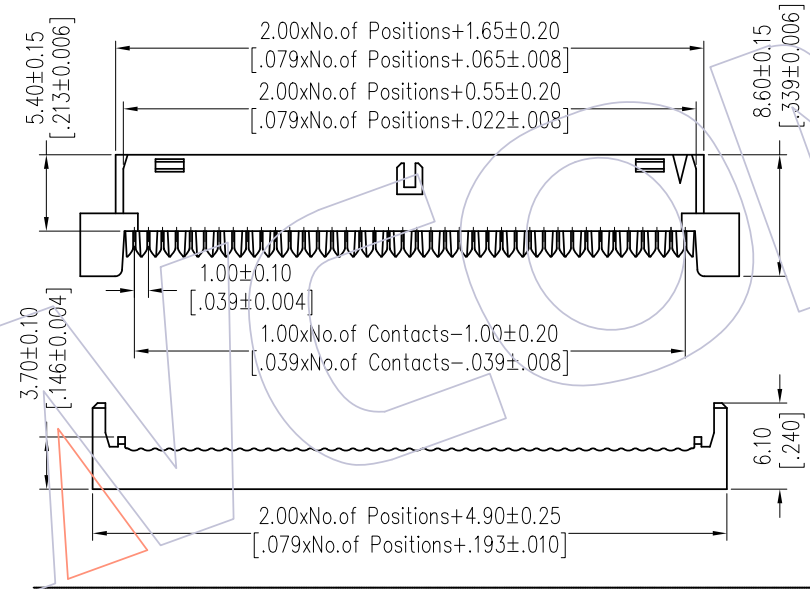

REV	DATE	MODIFICATION DESCRIPTION	CHANGE	OPERATION	DRAW	DATE	SCALE	FIT	PART NO.
A2	2018/05/29	MODIFY	---	x.x ±0.40	Ding	2018/05/29	UNIT	mm	5226-XXYPXXBW01
A1	2012/07/28	MODIFY	---	x.xx ±0.25	CHECK	DATE	inch	TITLE:	
A0	2010/09/28	NEW	---	x.xxx ±0.15	APPROVE	DATE	SIZE	A4	2.00mm IDC SOCKET "M" TYPE (WITH RAMP LOCKING)
				Angle ± 3'			SHEET	1/1	
				DIM TOL			PROJ.		

WCON
 Http: www.wcon.com

WCON-Dongguan Tel: +86 769 85358920 Fax: +86 769 85358915 E-mail: sales@wcon.com

WCON-Kunshan Tel: +86 512 57468408 Fax: +86 512 57468468 E-mail: salesks@wcon.com

X-ON Electronics

Largest Supplier of Electrical and Electronic Components

Click to view similar products for [I/O Connectors](#) category:

Click to view products by [Wcon](#) manufacturer:

Other Similar products are found below :

[571763P](#) [D20419-211](#) [72.250.1628.2](#) [72.250.2428.2](#) [76.350.0729.0](#) [76871-1403](#) [PCR-E36PM](#) [PCS-XE26LKA](#) [PCS-XES68MS+](#)
[G38A71314B](#) [9776-18-6](#) [1571250010](#) [157-22500-3](#) [MS3471L14-19P L/C](#) [192991-0703](#) [91-644626-35P](#) [172501-6002](#) [FCN-260C008-A/L0](#)
[FCN-260C024-AL0](#) [FCN-261Z008](#) [2000314-1](#) [200331-1](#) [PCS-E28FS+](#) [PCS-XE26SLFD+](#) [PCS-XE26SLFDT+](#) [G730VID08BDC24](#) [HDMR-](#)
[29-01-S-SM-TR](#) [HDRA-E68W1LFDTC-SL+](#) [HDR-E14MSG1+](#) [54182-0605](#) [UE86K842720321](#) [38113800006](#) [DP3AR020WQ1R200](#)
[Z4.102.0680.0](#) [500-1040](#) [500-1052](#) [500-1054](#) [ZP-4008-66L](#) [10-565995-597N](#) [10-584459-12P](#) [5554841-1](#) [SM3106F14S-7S-LC](#)
[U90B3054061110](#) [U65-E04-4020](#) [ZPF000000000097891](#) [557-262M2-06C](#) [PCS-96LFD+](#) [60-042222-02S](#) [10099439-003C-TRLF](#) [226-0348-](#)
[000](#)