

NOTES:
 Current Rating: 3.0AMP
 Contact Resistance: 30m Ω Max
 Withstand Voltage: 500V AC
 Insulation Resistance: 1000M Ω Min
 Operation Temperature: -55°C to +105°C

Contact Material: Brass Δ
 Contact plating: Au Or Sn over Ni
 Insulator Material: PBT+30%GF UL94V-0
 Shell: Steel, Sn Or Ni Plated
 Nut: Brass, Sn over Ni Plated

Ordering Information

6212-XX F X XX B 01

No. of Pins 15, 26, 44, 62
 Type Y=With Back Fork, S=Gold Flash/Tin, H=With Back Fork, S=10u"Gold/Tin, B=Black, U=Blue
 Insulator Color

NSI 1526, 44, 62P
 DIM "S" Nut 3.0, 4.0, 6.0, 6.5, 4.8

PINS	DIM "A"	DIM "B"	DIM "C"	DIM "D"	DIM "E"
62	70.50	62.50	54.89	54.80	54.30
44	53.05	47.04	38.33	41.10	38.20
26	39.20	33.32	24.76	27.70	24.90
15	30.99	24.99	16.34	18.81	15.81

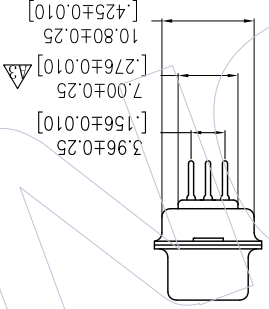
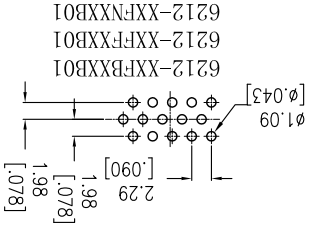
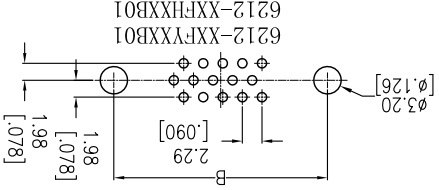
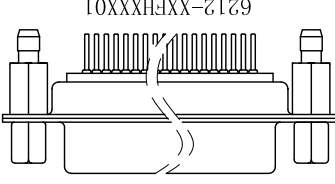
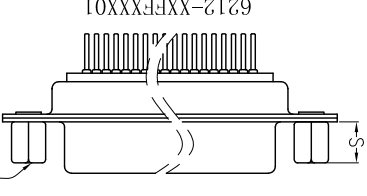
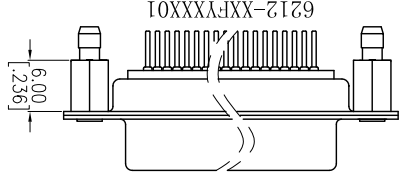
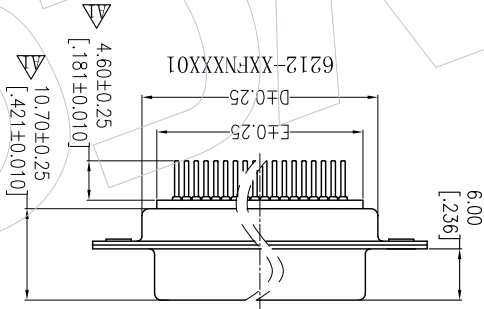
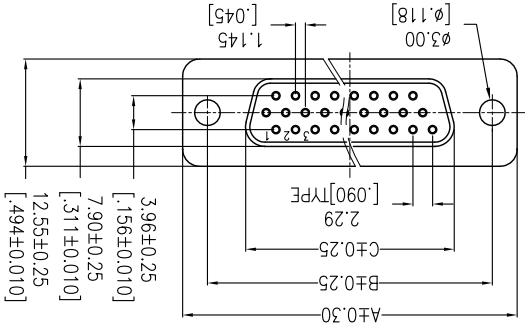

REV	DATE	MODIFICATION DESCRIPTION	CHANGE	DIM		APPROVE	DATE	PROJ.	Customer NO.	WCON-Dongguan			WCON-Kunshan		
				Angle	TOL					E-mail: sdies@wcon.com		Tel: +86 769 85358915		Fax: +86 512 57468408	
A3	2015/11/26	Modify	Δ		X.X	Allen	2015/11/26		6212-XXFXXXB01	WCON-Dongguan Tel: +86 769 85358915 Fax: +86 512 57468408 E-mail: sdies@wcon.com			WCON-Kunshan Tel: +86 512 57468408 Fax: +86 512 57468408 E-mail: sdies@wcon.com		
A2	2015/06/12	Modify The Contact Material	Δ		X.XX	CHECK			HD-SUB FEMALE THREE ROW 180° DIP TYPE	WCON-Dongguan Tel: +86 769 85358915 Fax: +86 512 57468408 E-mail: sdies@wcon.com			WCON-Kunshan Tel: +86 512 57468408 Fax: +86 512 57468408 E-mail: sdies@wcon.com		
A1	2014/03/31	Modify	Δ		X.XXX			A4		WCON-Dongguan Tel: +86 769 85358915 Fax: +86 512 57468408 E-mail: sdies@wcon.com			WCON-Kunshan Tel: +86 512 57468408 Fax: +86 512 57468408 E-mail: sdies@wcon.com		
A0	2012/12/04	NEW			±.3	APPROVE		SHEET 1/1		WCON-Dongguan Tel: +86 769 85358915 Fax: +86 512 57468408 E-mail: sdies@wcon.com			WCON-Kunshan Tel: +86 512 57468408 Fax: +86 512 57468408 E-mail: sdies@wcon.com		

X-ON Electronics

Largest Supplier of Electrical and Electronic Components

Click to view similar products for [wcon](#) manufacturer:

Other Similar products are found below :

[2185-140SG0AYNT1](#) [1125-1206G0S155C002](#) [2263-205SG0DYNT6](#) [2185-207ZG0CYNT1](#) [2157-140SG0CYNT1](#) [1125-2212G0S280C001](#)
[WF2543-1H03B01](#) [WF2543-1H04B01](#) [1220-1210G0M087P1](#) [WF2543-1H07B01](#) [2185DN1-205SG0CYNT1](#) [3622-S040-027G1R02](#) [2263-222RG0DYNT1](#) [1215-2114G0S076C002](#) [1325-1208G0Z093CT01](#) [1125-2208G0S360C001](#) [2220T-206MS0CUNT2](#) [3622-P040-038G1R02](#)
[WF1501-WM09ER1](#) [1125-1206G0M113CR01](#) [WF2005-2H09W01](#) [6223-09FMNS0B02](#) [6212-26FHS0B01](#) [3220-20SW0BST1](#) [WF2005-WR02ET2](#) [2185DN2-106SG0CYNT1](#) [2185-240SG0AYNT1](#) [2111P-232SG0FYNT4](#) [3111-20MSNBK00R1](#) [1125-2205G0S210C001](#) [2185-208SS0CYNT1](#) [2159-213RG0CUNT1](#) [2263D-204SG0DYNT6](#) [2185-209SS1CYNT2](#) [2211-112MG0CYNR4](#) [2227T-204MG3CUNR1](#) [2185-210SG0CYNR1](#) [6212-26MHS0B01](#) [3610-S020-040G1R01](#) [WF3001-2WR03BA1](#) [WF1001A-WZ06ET1](#) [6321D-040SDS1PNT01](#) [2185-208SSNCYNT1](#) [6320D-040RDS1PNT01](#) [WF2547-2H06B01](#) [2135-207MH3CUNR3](#) [2243-211WG0CUNT2](#) [2185-104ZG0CYNR1](#) [2272-209RG0CUNT1](#) [WF2549-2WS10S0B01](#)