

NOTES:
 Current Rating: 3.0AMP
 Contact Resistance: 30m Ω Max
 Withstand Voltage: 500V AC
 Insulation Resistance: 1000M Ω Min
 Operation Temperature: -55 $^{\circ}$ C to +105 $^{\circ}$ C

Contact Material: Brass
 Contact plating: Au Or Sn over Ni
 Insulator Material: PBT+30%GF UL94V-0
 Shell: Steel, Sn Or Ni Plated
 Nut: Brass, Sn over Ni Plated

Ordering Information

6212-XX F X XX B 01

No. of Pins	15, 26, 44, 62
Type	Y=With Back Fork H=With Back Fork S=Gold Flash/Tin S=10u"Gold/Tin S=15u"Gold/Tin F=With Front Nut N=Without Nut
Insulator Color	B=Black U=Blue
DIM "S" NUT 3.0 4.0 6.0 6.5 4.8	
PINS	DIM "A" DIM "B" DIM "C" DIM "D" DIM "E"
15	30.99 24.99 16.34 18.81 15.81
26	39.20 33.32 24.76 27.70 24.90
44	53.05 47.04 38.33 41.10 38.20
62	70.50 62.50 54.89 54.80 54.30

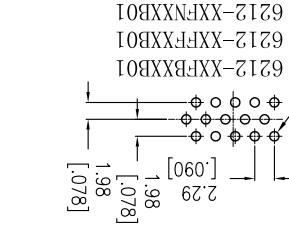
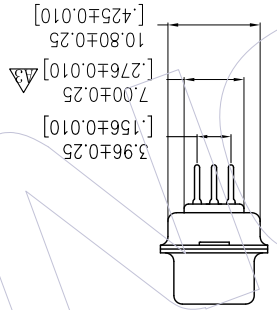
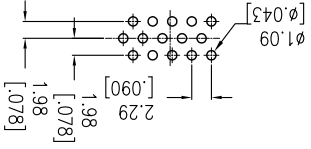
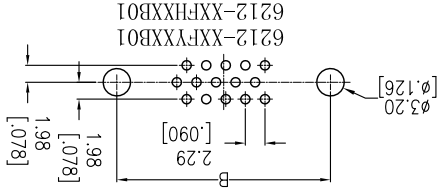
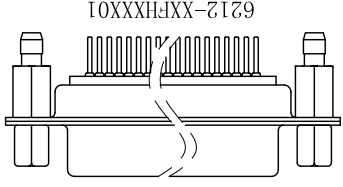
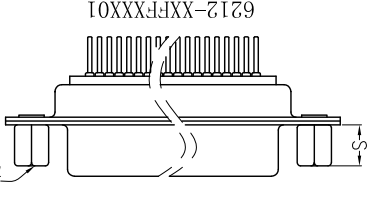
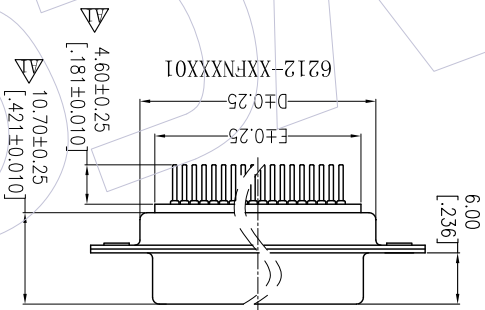
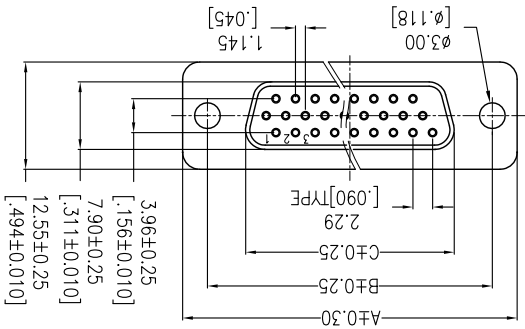

REV	DATE	MODIFICATION DESCRIPTION	CHANGE	DIM	TOL	APPROVE	DATE	PROJ.	CUSTOMER NO.	DATE	DATE	SCALE	FIT	UNIT	SIZE	SHEET	Customer NO.
A3	2015/11/26	Modify	△	X.X	±0.40	Allen	2015/11/26		6212-XXFXXXB01	2015/11/26	mm	A4	1/1				
A2	2015/06/12	Modify The Contact Material	△	X.XX	±0.25	CHECK			HD-SUB FEMALE THREE ROW 180° DIP TYPE								
A1	2014/03/31	Modify	△	X.XXX	±0.15												
A0	2012/12/04	NEW	---	Angle	±.3	APPROVE											

WCON
 WCON-Dongguan
 WCON-Kunshan
 Tel: +86 769 85358920
 Fax: +86 769 85358915
 E-mail: sdies@wcon.com
 Tel: +86 512 57468408
 Fax: +86 512 57468468
 E-mail: sdiesks@wcon.com
 Http: www.wcon.com

X-ON Electronics

Largest Supplier of Electrical and Electronic Components

Click to view similar products for [wcon](#) manufacturer:

Other Similar products are found below :

[2185-140SG0AYNT1](#) [1125-1206G0S155C002](#) [2263-205SG0DYNT6](#) [2185-207ZG0CYNT1](#) [2157-140SG0CYNT1](#) [1125-2212G0S280C001](#)
[WF2543-1H03B01](#) [WF2543-1H04B01](#) [1220-1210G0M087P1](#) [WF2543-1H07B01](#) [2185DN1-205SG0CYNT1](#) [3622-S040-027G1R02](#) [2263-](#)
[222RG0DYNT1](#) [1215-2114G0S076C002](#) [1325-1208G0Z093CT01](#) [1125-2208G0S360C001](#) [2220T-206MS0CUNT2](#) [3622-P040-038G1R02](#)
[WF1501-WM09ER1](#) [1125-1206G0M113CR01](#) [WF2005-2H09W01](#) [6223-09FMNS0B02](#) [6212-26FHS0B01](#) [3220-20SW0BST1](#) [WF2005-](#)
[WR02ET2](#) [2185DN2-106SG0CYNT1](#) [2185-240SG0AYNT1](#) [2111P-232SG0FYNT4](#) [3111-20MSNBK00R1](#) [1125-2205G0S210C001](#) [2185-](#)
[208SS0CYNT1](#) [2159-213RG0CUNT1](#) [2263D-204SG0DYNT6](#) [2185-209SS1CYNT2](#) [2211-112MG0CYNR4](#) [2227T-204MG3CUNR1](#) [2185-](#)
[210SG0CYNR1](#) [6212-26MHS0B01](#) [3610-S020-040G1R01](#) [WF3001-2WR03BA1](#) [WF1001A-WZ06ET1](#) [6321D-040SDS1PNT01](#) [2185-](#)
[208SSNCYNT1](#) [6320D-040RDS1PNT01](#) [WF2547-2H06B01](#) [2135-207MH3CUNR3](#) [2243-211WG0CUNT2](#) [2185-104ZG0CYNR1](#) [2272-](#)
[209RG0CUNT1](#) [WF2549-2WS10S0B01](#)