

HSF

NOTES:
 Current Rating: 10A
 Voltage Rating: 300V
 Contact Resistance: 8milliohm Max
 Withstand Voltage: AC2000V
 Insulation Resistance: 1000Megohm Min
 Screw Torque: 4.4 lbf.in
 Wire range: 12-30AWG
 Operation Temperature: -40℃ to +105℃

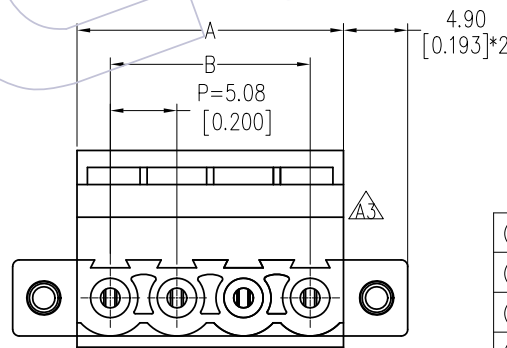
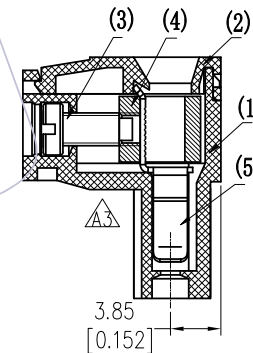
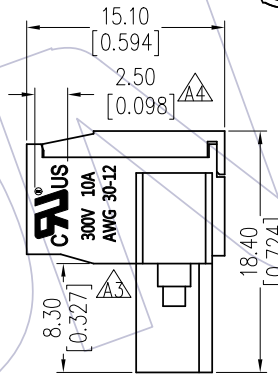
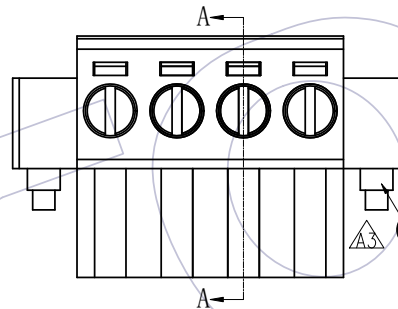
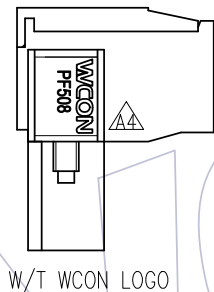
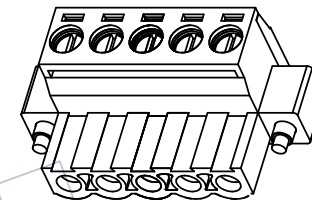
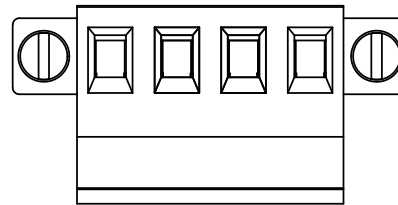
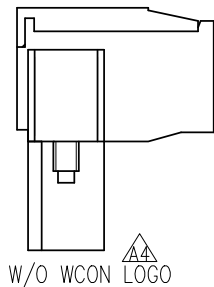

Ordering Information:

P F 508- C XX A SM W 1 N

F=Female Pitch No.of Pins Contact Plated Blank=W/T WCON Logo
 508=5.08 02-24P SM=Matte Tin N=W/O WCON Logo
 Color Type
 A=Green W=With Screw

13P	66.04 ± 0.30	60.96 ± 0.30			
12P	60.96 ± 0.30	55.88 ± 0.30	24P	121.92 ± 0.50	116.84 ± 0.50
11P	55.88 ± 0.30	50.80 ± 0.30	23P	116.84 ± 0.50	111.76 ± 0.50
10P	50.80 ± 0.30	45.72 ± 0.30	22P	111.76 ± 0.50	106.68 ± 0.50
9P	45.72 ± 0.30	40.64 ± 0.30	21P	106.68 ± 0.50	101.60 ± 0.50
8P	40.64 ± 0.30	35.56 ± 0.30	20P	101.60 ± 0.50	96.52 ± 0.50
7P	35.56 ± 0.20	30.48 ± 0.20	19P	96.52 ± 0.40	91.44 ± 0.40
6P	30.48 ± 0.20	25.40 ± 0.20	18P	91.44 ± 0.40	86.36 ± 0.40
5P	25.40 ± 0.20	20.32 ± 0.20	17P	86.36 ± 0.40	81.28 ± 0.40
4P	20.32 ± 0.20	15.24 ± 0.20	16P	81.28 ± 0.40	76.20 ± 0.40
3P	15.24 ± 0.20	10.16 ± 0.20	15P	76.20 ± 0.40	71.12 ± 0.40
2P	10.16 ± 0.20	5.08 ± 0.10	14P	71.12 ± 0.40	66.04 ± 0.40
PIN	A	B	PIN	A	B

ITEM	品名	料号	数量	材料
(6)	Screw-2	MC025-1SZC01	2	C1018
(5)	Contact	TPT051-PSM002	N	C5191R-H T=0.4mm
(4)	Pin Block	BL025-1SNI01	N	C3604
(3)	Screw	MA025-1SXX01	N	C1018
(2)	Cover	XPC508-XXB1XN1	1	PA66 UL94-V0
(1)	Housing	XPF508-XXB1XW1(N)	1	PA66 UL94-V0

A4	2020/08/03	ADD LOGO;ADD W/O LOGO P/N	XSR	OPERATION	DRAW	DATE	SCALE	FIT	PART NO.
A3	2015/12/15	Modify	—	X.X ±0.40	XSR	2020/08/03	UNIT	mm	PF508-CXXASMW1(N)
A2	2015/07/15	Modify	—	X.XX ±0.25	CHECK	DATE	SIZE	inch	TITLE:
A0	2011/06/08	NEW	—	X.XXX ±0.15	APPROVE	DATE	SHEET	A4	5.08mm Pitch Female
REV	DATE	MODIFICATION DESCRIPTION	CHANGE	Angle ± 3°			PROJ.	1/1	Pluggable Terminal Blocks
				DIM TOL					Customer NO.

WCON
 Http: www.wcon.com

WCON-Dongguan Tel: +86 769 85358920
 WCON-Kunshan Tel: +86 512 57468408
 Fax: +86 769 85358915 Fax: +86 512 57468468
 E-mail: sales@wcon.com E-mail: salesks@wcon.com

X-ON Electronics

Largest Supplier of Electrical and Electronic Components

Click to view similar products for [Pluggable Terminal Blocks](#) category:

Click to view products by [Wcon](#) manufacturer:

Other Similar products are found below :

[57.510.0053](#) [MC 1.5/ 6-ST-3.5 GY AU](#) [ET02015000J0G](#) [734-104](#) [734-302](#) [860505](#) [860516](#) [860810](#) [GBPACX-12](#) [93.731.4953.0](#) [PV05-5,08-K](#) [PVP03-3,50](#) [PVP04-3,50](#) [PVS02-5,00](#) [1-1986160-3](#) [1377680000](#) [1531000000](#) [1546228-5](#) [ELFP03110](#) [ELFT07250](#) [ELVD12100](#) [ELVF09400](#) [ELVP03100](#) [ELXH071G0E](#) [1700410](#) [1702246](#) [1705229](#) [1714537](#) [1717806](#) [1719600](#) [1728941](#) [1734692](#) [1734795](#) [1740291](#) [1740628](#) [1746952](#) [1750207](#) [1752865](#) [1754115](#) [1754144](#) [1756913](#) [1760051](#) [1760336](#) [1765111](#) [1776388](#) [1777701](#) [1783410](#) [1800227](#) [1801080](#) [1809474](#)