



NOTES:  
Rated Current:9.0AMP  
Contact Resistance:30mΩ max  
Withstand Voltage:1500V AC/minute  
Insulation Resistance:100MΩ min  
Operation Temperature:-25℃ to +85℃

Contact Material:Brass  
Contact Plating:Sn Over Ni  
Insulator Material:P66 White(UL94-V0)

### Ordering Information

WF4201-2WS XX W X 7

W X 7  
Packing  
0=PE Bag  
=White  
W=Blank  
Blank=Tin  
Contact Plating  
No. of pins  
01-12P  
Insulation Material  
Blank=P66

Recommended P.C.B Layout(Top Side)  
(PCB BOARD TOLERANCE±0.05)

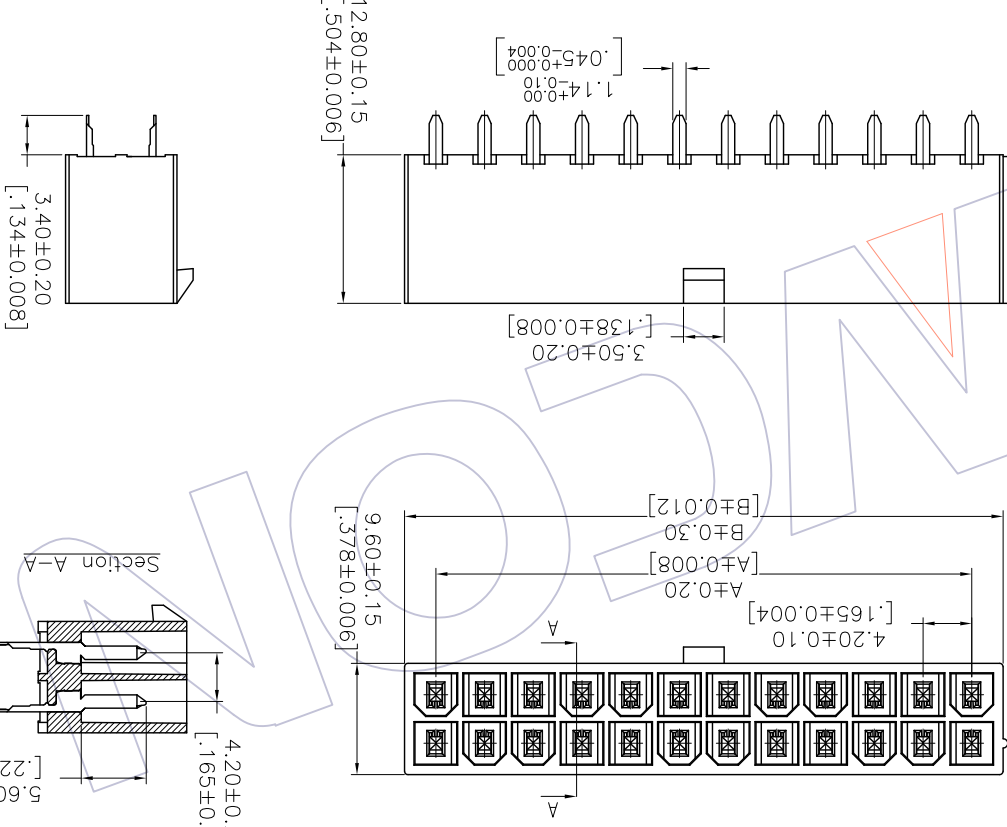
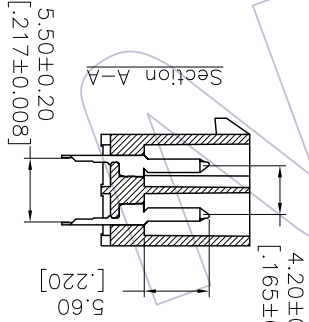
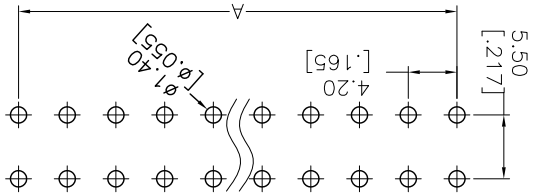

| Circuit | Part No.        | Dimension |       |
|---------|-----------------|-----------|-------|
|         |                 | A         | B     |
| 2x01    | WF4201-2WS01WX7 | ---       | 5.40  |
| 2x02    | WF4201-2WS02WX7 | 4.20      | 9.60  |
| 2x03    | WF4201-2WS03WX7 | 8.40      | 13.80 |
| 2x04    | WF4201-2WS04WX7 | 12.60     | 18.00 |
| 2x05    | WF4201-2WS05WX7 | 16.80     | 22.20 |
| 2x06    | WF4201-2WS06WX7 | 21.00     | 26.40 |
| 2x07    | WF4201-2WS07WX7 | 25.20     | 30.60 |
| 2x08    | WF4201-2WS08WX7 | 29.40     | 34.80 |
| 2x09    | WF4201-2WS09WX7 | 33.60     | 39.00 |
| 2x10    | WF4201-2WS10WX7 | 37.80     | 43.20 |
| 2x11    | WF4201-2WS11WX7 | 42.00     | 47.40 |
| 2x12    | WF4201-2WS12WX7 | 46.20     | 51.60 |

Dimensional & Ordering Information

| REV | DATE       | MODIFICATION DESCRIPTION | CHANG | DIM   | TOL   | APPROVE   | DATE                          | PROJ.   | Customer NO. |
|-----|------------|--------------------------|-------|-------|-------|-----------|-------------------------------|---------|--------------|
| A0  | 2017/10/17 | NEW                      |       | Angle | ± 3'  | DATE      | DATE                          | PROJECT |              |
|     |            |                          |       | X.xxx | ±0.15 | CHECK     | DATE                          | SHEET   |              |
|     |            |                          |       | X.xx  | ±0.25 | DRAW      | DATE                          | SIZE    |              |
|     |            |                          |       | X.x   | ±0.40 |           | 2017/10/17                    | A4      |              |
|     |            |                          |       |       |       | OPERATION | SCALE                         | UNIT    |              |
|     |            |                          |       |       |       | Dwg       | mm                            | mm      |              |
|     |            |                          |       |       |       |           | FIT                           | mm      |              |
|     |            |                          |       |       |       |           | SEE TAB                       |         |              |
|     |            |                          |       |       |       |           | TITLE:                        |         |              |
|     |            |                          |       |       |       |           | 4.20 MINI FIT DUAL ROW 180°   |         |              |
|     |            |                          |       |       |       |           | WITH SHORT BUMPS WITHOUT POST |         |              |
|     |            |                          |       |       |       |           | WCON-Dongun                   |         |              |
|     |            |                          |       |       |       |           | WCON-Kunshan                  |         |              |
|     |            |                          |       |       |       |           | Tel: +86 769 85358920         |         |              |
|     |            |                          |       |       |       |           | Fax: +86 769 85358915         |         |              |
|     |            |                          |       |       |       |           | E-mail: sales@wcon.com        |         |              |
|     |            |                          |       |       |       |           | Fax: +86 512 57468468         |         |              |
|     |            |                          |       |       |       |           | E-mail: sales@wcon.com        |         |              |

**WCON**

Http://www.wcon.com

WCON-Dongun  
WCON-Kunshan  
Tel: +86 769 85358920 Fax: +86 512 57468468  
E-mail: sales@wcon.com

HSF

|     |            |                          |        |             |           |            |           |   |                        |
|-----|------------|--------------------------|--------|-------------|-----------|------------|-----------|---|------------------------|
| REV | DATE       | MODIFICATION DESCRIPTION | CHANGE | DIM TOL     | APPROVE   | DATE       | PROJ.     | Customer NO.  | E-mail: sales@wcon.com |
| A0  | 2017/10/17 | NEW                      | —      | Angle ±.3°  |           |            |           |   | Fax: +86 769 85358915  |
|     |            |                          |        | X.XXX ±0.15 | CHECK     | DATE       | SHEET 2/2 | 4.20 MINI FIT DUAL ROW 180° WITH SHORT BUMP WITHOUT POST. | Tel: +86 769 85358920  |
|     |            |                          |        | X.XX ±0.25  | DRAW      | DATE       | SIZE A4   |   | WCON-Dongguan          |
|     |            |                          |        | X.X ±0.40   | Ding      | 2017/10/17 | UNIT mm   | TITLE: WF4201-2WSXXXW7                                    | WCON-Kunshan           |
|     |            |                          |        |             | SCALE FIT |            |           |   | Http: www.wcon.com     |

2x10P

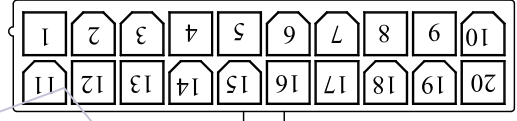

2x11P

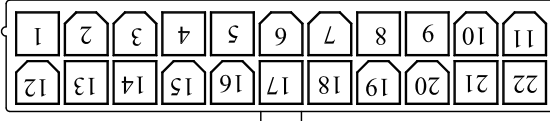

2x12P

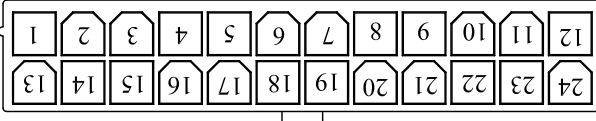

2x06P

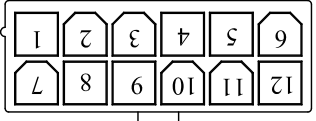

2x07P

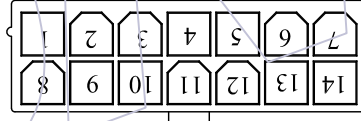

2x08P

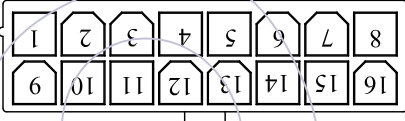

2x09P

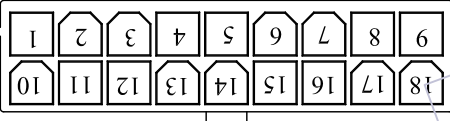

2x01P

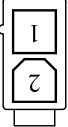

2x02P

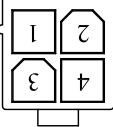

2x03P

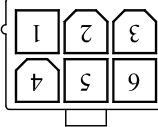

2x04P

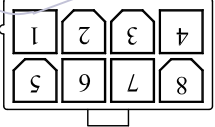

2x05P

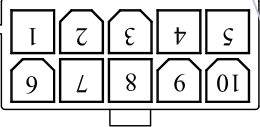

A B C D E F G H

10 9 8 7 6 5 4 3 2 1

## X-ON Electronics

Largest Supplier of Electrical and Electronic Components

*Click to view similar products for [Headers & Wire Housings](#) category:*

*Click to view products by [Wcon](#) manufacturer:*

Other Similar products are found below :

[95000-104TRLF](#) [10135584-644402LF](#) [DF62W-EP2022PCA](#) [95000-106TRLF](#) [DF62W-2022SCA](#) [DF62W-EP2022PC](#) [2203348](#) [DF62W-2022SC](#) [1084018](#) [1029039](#) [1084017](#) [802-10-012-10-002000](#) [1112640](#) [1112639](#) [891-007-9SS-BST1T](#) [000-34000](#) [0008550134](#) [0009482033](#) [0009507031](#) [57102-F02-18ULF](#) [57102-S06-03LF](#) [57202-S52-04LF](#) [PCN6-15S-2.5E](#) [0039019024](#) [58102-G61-06LF](#) [582553-1](#) [0009485154](#) [0009508121](#) [0022285053](#) [0050291907](#) [018731A](#) [LY20-4P-DT1-P1E-BR](#) [02.125.8002.8](#) [60101931](#) [60598-1 \(Cut Strip\)](#) [M1625-3R/100](#) [61062-3](#) [61082-181009](#) [CSU011177004](#) [636-1427](#) [638009-1](#) [641938-9](#) [641991-4](#) [644168-1](#) [644827-2](#) [647662-1](#) [65039-019ELF](#) [65692-001LF](#) [65781-018](#) [65781-047](#)