



WeEn

WeEn Semiconductors



MOTOR CONTROL



EV CHARGER



TELECOM POWER



SOLAR INVERTER



HOME APPLIANCE

WeEn Semiconductors

PRODUCT SELECTION GUIDE

WeEn Semiconductors: Span off from NXP, Over 50-Years Leading Experience in Power



PHILIPS

High Voltage Transistors (HVT)
Fast, Ultrafast & Hyperfast Power Diodes
Bipolar 4-Quadrant Triacs

1980s

Hyperfast diodes
Triac & SCR Planar
Technology Platform

NXP

2006

ACT & ACTT Platform
(AC Switch), Casco Diodes

WeEn

Silicon Carbide Diodes
Enhanced Efficiency Pt Planar diodes (EEPP)
Generation 2: Schottky Barrier Diodes
High Voltage SCRs

2013

Temperature & Overload Protected Triac (TOPTriac)

2020

Automotive SiC
Standard Power Diodes
Automotive SCRs
1600V Planar SCRs

1969

Bipolar 3-Quadrant
Hi-Com Triacs

2000s

Super Advanced Best Efficiency Rectifier Diodes (SABER)
Generation 1: Schottky Barrier Diodes

2009

2015



WeEn
WeEn Semiconductors

WeEn Semiconductors Co., Ltd, span off from NXP, registered on Aug 5, 2015. The operational headquarters locates in Shanghai and the company's wholly-owned subsidiaries and branches include: the front-end fabrication in Jilin, north east China, the warehouse and distribution center in Hong Kong and research & development centers in Shanghai and Manchester, UK. WeEn also has sales offices set up and customer service access throughout the world.

As a key player in the semiconductor industry, WeEn has focused on developing a large portfolio of industry-leading bipolar power products including thyristors (i.e. silicon controlled rectifiers and triacs), silicon power diodes and high voltage transistors. Additionally, WeEn has developed a state-of-the-art portfolio of silicon carbide diodes and power Schottky diodes as well as making available a number of AECQ products. All these products are widely used in the markets for telecommunications, computers, consumer electronics, intelligent home appliances, lighting, automotive and power management applications.

With over 50 years of design and manufacture experience, WeEn helps to drive up efficiency in your designs and to contribute to the development of China and global intelligent manufacturing.

aim is to help our customers achieve higher cost efficiency and production efficiency and to contribute to the development of China and global intelligent manufacturing.

瑞能半导体科技股份有限公司，源自恩智浦半导体标准产品事业部，注册于2015年8月5号，运营中心落户上海，全资子公司和分支机构包括吉林芯片生产基地、上海和英国产品及研发中心、香港物流中心以及遍布全球其他国家的销售和客户服务点。

作为全球功率半导体行业的佼佼者，瑞能始终专注于研发行业领先、广泛且深入的双极功率半导体产品组合，包括：碳化硅二极管，可控硅整流器和三端双向可控硅、功率二极管、高压晶体管等。产品广泛应用于电信、计算机、消费类电子产品、智能家电、照明、汽车和电源管理应用等市场领域。

自诞生以来，瑞能已走过逾50年辉煌历程，作为全球功率半导体行业的佼佼者，我们的目标是帮助客户提高成本效益和生产效率，促进中国及全球智能制造行业的发展。

CONTENTS

AC Thyristor Triacs / AC Thyristors	04
AC Thyristor Triacs	
AC Thyristors	
Temperature and Overload Protected Triacs (Toptriac)	
3Q Hi-com Triacs (0.8A - 45A)	05
4Q Triacs (0.6A - 45A)	06
Silicon Controlled Rectifiers (0.8A - 126A)	07
Power Diodes	08
Hyperfast Power Diodes	
1200V Planar Hyperfast Power Diodes	
Power Diodes	09
Ultrafast Power Diodes	
SiC Schottky Diode	10
Power Schottky Diodes	11
600V - 1600V Standard Power Diodes	
Power Diode Bridge	
Power Diode Module	
WeEn High Voltage 1600V SCRs	
1600V/50A & 1600V/80A, Planar Passivated	12
WeEn 30A Hi-Com™ Triacs	13
DFN 8x8 Package	14
WeEn Silicon Carbide Junction Barrier Schottky (JBS)	
650V and 1200V Series	15
WeEn Products for EV On Board Charger	16
WeEn Products in Smart Home	17
Certifications	18
WeEn Nanchang Reliability & Failure Analysis Laboratory	19

AC Thyristor Triacs / AC Thyristors

AC Thyristor Triacs

(3Q Hi-Com power switches, overvoltage protection)

Types in **bold red** represent new products

$I_{T(RMS)}$ (A)	V_{DRM} (V)	I_{GT} (max) (mA)	SOT78 (TO220AB)	SOT186A (isolated TO220AB)	SOT223	SOT226 (I ² PAK)	SOT404 (D ² PAK)	SOT428 (DPAK)
2	800	E		ACTT2X				ACTT2S
2	800	ETN		ACTT2X	ACTT2W			ACTT2S
4	800	C/E		ACTT4X				ACTT4S
6	800	E	ACTT6	ACTT6X		ACTT6G	ACTT6B	
6	800	CN	ACTT6	ACTT6X			ACTT6B	
8	800	C0/C0T	ACTT8	ACTT8X			ACTT8B	
8	800	CTN	ACTT8	ACTT8X			ACTT8B	
10	800	C/CT	ACTT10	ACTT10X				
10	800	CTN	ACTT10	ACTT10X			ACTT10B	
12	800	C/CT	ACTT12	ACTT12X			ACTT12B	
12	800	CTN	ACTT12	ACTT12X			ACTT12B	
16	800	CTN	ACTT16	ACTT16X			ACTT16B	

I_{GT} key: C = 35 mA; C0 = 5 - 30 mA; E = 10 mA

T : high $T_j(\max)$ 150 °C N: Enhanced Dynamic Performance

In the spotlight

AC Thyristor Triacs ACTT10 series, ACTT12 series

Planar passivated with overvoltage clamping function

High energy surge handling

Very high dV/dt for maximum immunity to false triggering

High $T_j(\max)$ to 150 °C



AC Thyristors

(2Q Hi-Com power switches, exclusive negative gate triggering, 'Common' mounting base, overvoltage protection)

$I_{T(RMS)}$ (A)	V_{DRM} (V)	I_{GT} (max) (mA)	SOT54 (TO92)	SOT223	SO8
0.2	600	D			ACT102H
0.8	600	D/E	ACT108	ACT108W	
0.8	800	E	ACT108	ACT108W	

I_{GT} key: D = 5 mA; E = 10 mA

In the spotlight

AC Thyristors ACT108-800E , ACT108W-800E

Planar passivated with overvoltage clamping function

Working voltage increased to 800V

Enhanced overvoltage clamping capability

High false trigger immunity

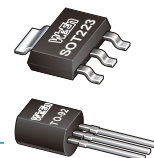

Temperature and Overload Protected Triacs (Toptriac)

2Q Hi-Com power switches, exclusive negative gate triggering, over-temperature protection

Types in **bold red italic** represent products in development

$I_{T(RMS)}$ (A)	V_{DRM} (V)	I_{GT} (max) (mA)	SOT78 (TO220)	TO263 (D ² PAK)
12	800	C0	TOPT12	
16	800	C0	TOPT16	<i>TOPT16B</i>

I_{GT} key:
C0 = 5 - 35mA

In the spotlight

TOPTriac TOPT12, TOPT16

Planar passivated for voltage ruggedness & reliability

Over temperature & over load protection

No need to over-specify triac and heatsink

Avoid loss of control at high temperature

Status monitoring with help of microcontroller



AC Thyristor Triacs part numbering

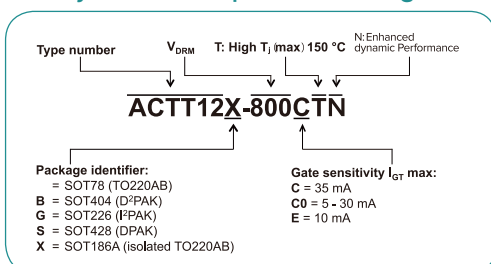

AC Thyristors part numbering

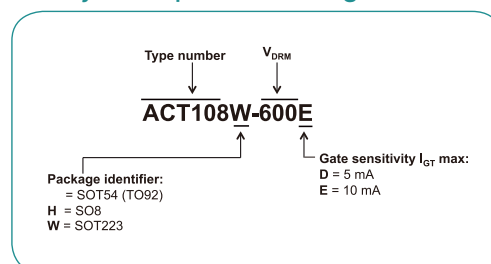

3Q Hi-Com Triacs (0.8A - 45A)

Types in **bold red** represent new products
Types in **bold red italic** represent products in development

$I_{T(RMS)}$ (A)	V_{DRM} (V)	$I_{GT(max)}$ (mA)	SOT54 (TO92)	SOT78 (TO220AB)	SOT78D (internally insulated TO220AB)	SOT186A (isolated TO220AB)	SOT223	SOT226 (I ² PAK)	SOT404 (D ² PAK)	SOT428 (DPAK)	SOT1292 (internally insulated TO-3P)	
0.8	600 / 800	D						BTA2008W				
	600 / 800	D/E	BTA2008									
	1000	D	BTA2008									
	1000	DN	BTA2008									
1	600 / 800	B/E/ER	BTA201									
	600 / 800	E					BTA201W					
	600	B/C/D/E/F					BTA204W*					
2	600 / 800	D/E				BTA202X						
	800	CT	BTA203									
4	600	B/C/D/E/F		BTA204		BTA204X					BTA204S	
	800	B/C/E		BTA204		BTA204X					BTA204S	
	1000	C				BTA204X					BTA204S	
6	800	CT/ET		BTA206		BTA206X						
	600	D		BTA208		BTA208X					BTA208S	
	600 / 800	B/E/F		BTA208		BTA208X					BTA208S	
	800	CT				BTA208X						
	800	B0/C0				BTA308X						
	800	C0T			BTA308Y							
	800	ET		BTA308		BTA308X					BTA308S	
	800	F0				BTA308X						
	1000	B				BTA208X						
	1000	C0				BTA208X						
10	600 / 800	C/D/E		BTA310		BTA310X						
	600 / 800	BT/CT/ET		BTA410*	BTA410Y*	BTA410X*						
12	600	CT		BTA312				BTA312G		BTA312B		
	600	D		BTA312		BTA312X				BTA312B		
	600 / 800	B/C/E		BTA312		BTA312X				BTA312B		
	600 / 800	C			BTA312Y							
	600 / 800	B/C			BTA412Y*							
	600 / 800	ET			BTA412Y*							
	800	CT		BTA312		BTA312X						
	800	ET		BTA312						BTA312B		
	600	BT		BTA316						BTA316B		
	600	B0		BTA316						BTA316B		
16	600	CT								BTA316B		
	600	D		BTA316								
	600 / 800	B/C/E		BTA316		BTA316X				BTA316B		
	600 / 800	ET		BTA316								
	600 / 800	B/C			BTA416Y*							
	800	B0		BTA316		BTA316X						
	800	BT/CT			BTA316Y							
	800	CT		BTA316		BTA316X						
	20	800	BT/CT		BTA420*	BTA420Y*	BTA420X*					
	25	600	BT		BTA225							
600 / 800		B		BTA225						BTA225B		
800		BT								BTA225B		
800		BT/CT			BTA425Y*							
800		B/BT				BTA425X*						
30	800	BT		BTA330		BTA330X						
	800	BT/CT			BTA330Y					BTA330B		
40	800	BT									BTA440Z*	
45	800	BT										BTA445Z

3Q Triacs part numbering

*high surge I_{TSM} I_{GT} key: B = 50 mA, B0 = 10 - 50 mA, C = 35 mA, C0 = 5 - 35 mA, D = 5 mA, E = 10 mA, F = 25 mA T: high $T_j(max)$ 150 °C R: ACT Pinning

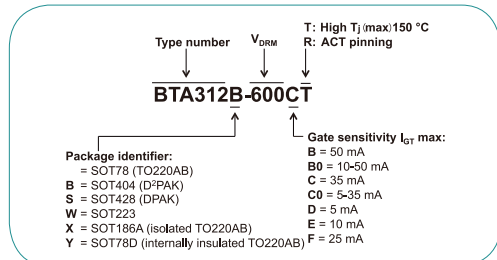

In the spotlight

3Q Hi-Com Triacs BTA425, BTA330, BTA440, BTA445

Planar passivated for voltage ruggedness and reliability

High junction operating temperature capability (150 °C)
Less sensitive gate for high noise immunity



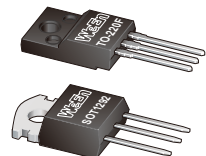





High commutation, high dV/dt for maximum immunity to false triggering



4Q Triacs

(0.6A - 45A)

Types in **bold red** represent new products

$I_{T(RMS)}$ (A)	V_{DRM} (V)	$I_{GT(max)}$ (mA)	SOT54 (TO92)	SOT78 (TO220AB)	SOT78D (internally insulated TO220AB)	SOT82	SOT186A (isolated TO220AB)	SOT223	SOT404 (D ² PAK)	SOT428 (DPAK)	SOT1292 (internally insulated TO-3P)
											
0.6	400	5/5/5/7	MAC97A6								
	600	5/5/5/7	MAC97A8								
1	600	3/3/3/7						BT131W			
	600 / 800	3/3/3/7	BT131								
	600 / 800	5/5/5/7	BT131-D								
	600 / 800	10/10/10/10	BT131-E								
	600 / 800	3/3/3/5	Z0103MA/NA					Z0103MN/NN			
	600 / 800	5/5/5/7	Z0107MA/NA					Z0107MN/NN			
	600 / 800	10/10/10/10	Z0109MA/NA					Z0109MN/NN			
	600 / 800	3/3/3/5	Z0103MA0/NA0**					Z0103MN0/NN0**			
	600 / 800	5/5/5/7	Z0107MA0/NA0**					Z0107MN0/NN0**			
	600 / 800	10/10/10/10	Z0109MA0/NA0**					Z0109MN0/NN0**			
	600	5/5/5/10	BT132-D*								
	600	D/E/-							BT134W*		
800	-							BT134W*			
4	600	D/E/-G				BT134					
	800	E/-				BT134					
	600 / 800	D/E		BT234*			BT234X*				
	600	D/-		BT136			BT136X				BT136S
	800	D									BT136S
	600	F					BT136X				BT136S
	600 / 800	E		BT136			BT136X		BT136B		BT136S
	800	F									BT136S
6	800	-					BT136X				BT136S
	600	F/-G					BT236X				
8	800	-G					BT236X				
	600	D/-G		BT137			BT137X				BT137S
	600	E		BT137			BT137X		BT137B		BT137S
	600	F					BT137X		BT137B		BT137S
	600 / 800	G0/G0T		BT137							
	800	E		BT137			BT137X		BT137B		BT137S
	800	F						BT137B		BT137S	
	800	-		BT137			BT137X		BT137B		BT137S
12	800	G							BT137B		BT137S
	600	D		BT138			BT138X				
	600	-G		BT138			BT138X		BT138B		
	600	F					BT138X		BT138B		
	600	G0/G0T		BT138							
	600 / 800	E		BT138	BT138Y		BT138X		BT138B		
16	800	F					BT138X				
	800	-		BT138			BT138X				
	800	G		BT138							
	600 / 800	B			BTA16						
	600	E/-		BT139			BT139X		BT139B		
	600	F/G					BT139X		BT139B		
	600	G0/G0T		BT139							
	800	E		BT139					BT139B		
20	800	F							BT139B		
	800	-		BT139			BT139X		BT139B		
25	800	G		BT139					BT139B		
	600 / 800	-									
40	600 / 800	B									BTA41
45	800	B									BTA45

I_{GT} key:
D = 5mA (10mA in 3+); E = 10mA (25mA in 3+); F = 25mA (70mA in 3+); - = 35mA (70mA in 3+); G = 50mA (100mA in 3+);
G0 = 50mA (100mA in 3+), 10mA min
* High I_{TSM} ** Enhanced immunity to false triggering T: high $T_J(max)$ 150°C

4Q Triacs part numbering

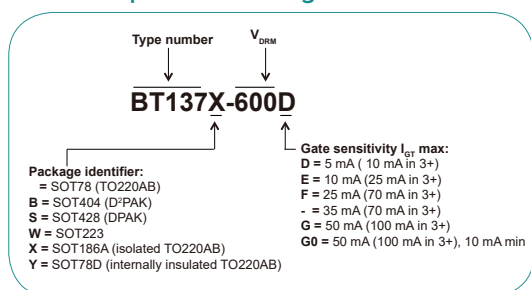

In the spotlight

4Q Triacs Z010***0 series

Planar passivated for voltage ruggedness and reliability

Improved dynamic performance over Z010*** series

Best false trigger immunity for sensitive 4Q triacs

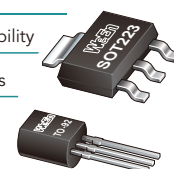

Silicon Controlled Rectifiers

(0.8A - 126A)

Types in **bold red** represent new products
Types in **bold red italic** represent products in development

$I_{T(RMS)}$ (A)	$I_{T(AV)}$ (A)	V_{DRM} & V_{BRM} (V)	I_{GT} (max) (mA)	SOT54 (TO92)	SOT78 (TO220AB)	SOT82	SOT89	SOT186A (isolated TO220AB)	SOT223	SOT404 (D ² PAK)	SOT428 (DPAK)	SOT429 (TO-247)	SOT533 (IPAK)	SOT1259 (TO-3P)	SOT1292	IITO220		
0.8	0.5	200	0.2															
		400	0.012	EC103D1														
		600	0.5µA min - 7µA max	NO118GA														
		200 / 400 / 600	0.2	BT149B/D/G														
		200 / 400 / 600	0.2	BT169B/D/G														
		400	0.015 min - 0.05 max	BT169D-L														
		500 / 600	0.02 min - 0.2 max	BT168E/G														
		600	0.015 min - 0.05 max	BT169G-L														
		600	0.03 min - 0.06 max	BT169G-M														
		600	0.015 min - 0.1 max						NCR100Q-6M									
800	0.1	BT169H																
800	0.015 min - 0.05 max	BT169H-L																
1	0.6	600	0.02 min - 0.2 max															
		600	0.07 min - 0.45 max															
		600	0.2															
1.1	0.7	850	0.015 min - 0.05 max															
		850	0.1															
		1000	0.015 min - 0.05 max															
1.25	0.8	1000	0.1															
		1250	0.1															
4	2.5	400 / 500 / 600	0.2															
		500	0.2															
		600	0.2															
8	5	500 / 600 / 800	0.2															
		600	0.2															
		600	5															
		800	0.05															
		800	0.2															
12	7.5	650	0.2															
		500 / 650	5															
		600	5															
		650	5															
		650	1.5-5															
		650	15															
		500 / 650 / 800	15															
16	10	500 / 650 / 800	15															
		500 / 1000	15															
		600	15															
		600 / 800	25															
20	13	400 / 600 / 800	32															
		500	32															
		600	32															
25	16	800	1.5 - 10															
		800	35															
30	19	800	15															
31	20	1200	32															
40	25	800	15															
47	30	1200	50															
79	50	1200	50															
		1200	50															
		1400	50															
		1600	80															
94	60	1400	80															
126	80	1200	70															
		1600	80															

high I_{TSM} ** Hi-Com / fast turn-off T: high T_j (max) 150 °C A: Automotive qualified AEC-Q101

Silicon Controlled Rectifiers part numbering

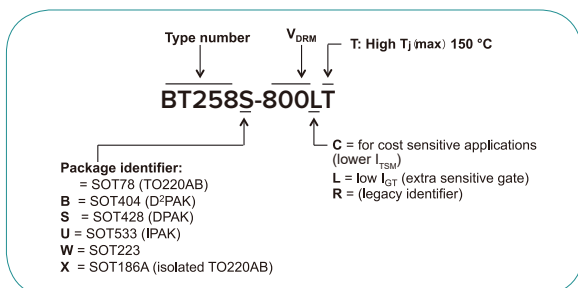

In the spotlight

High Voltage, high surge capability SCR BT155 series, BT158, TYN60

Planar passivated for voltage ruggedness and reliability

Very low on-state voltage (V_r) contributes to best efficiency in AC-DC conversion

High junction operating temperature capability (T_{jmax} 150 °C)

Less sensitive gate for high noise immunity

Power Diodes

Hyperfast Power Diodes

Types in **bold red** represent new products
Types in **bold red italic** represent products in development

V _{RRM} (V)	I _{F(AV)} (A)	V _F (typ) @ 150C (V)	@ I _F (A)	t _{rr} (typ) @ 25C (ns)	SOD59 (TO220AC)	SOD113 (2-pin SOT186A)	SOD142 (2-pin TO247)	SOT429 (3-pin TO247)	SOT78 (TO220AB)	IIT0220	SOT186A (TO220FP)	SOT404 (D ² PAK)	TO247-2L
400	2 x 5	0.85	5	30							BYC405X-400P		
500	5	1.15	5	16	BYC5D-500	BYC5DX-500							
600	5	1.4	5	19								BYC5B-600	
	5	1.55	5	13	BYC5-600P	BYC5X-600P							
	8	1.4	8	20	BYC8D-600	BYC8DX-600							
	8	1.4	8	19	BYC8-600P	BYC8X-600P							BYC8B-600P
	10	1.4	10	19									BYC10B-600
	10	1.3	10	19	BYC10-600P	BYC10X-600P							
	10	1.4	10	18	BYC10D-600	BYC10DX-600							
	2 x 5	1.4	5	19						BYC10-600CT			
	15	1.4	15	22	BYC15-600P	BYC15X-600P							
	20	1.4	20	19	BYC20-600								
	20	1.2	20	26	BYC20D-600P	BYC20DX-600P							
	20	1.2	20	25		BYC20X-600P							
	30	1.5	30	26			BYC30DW-600P						
30	1.38	30	29	BYC30-600P	BYC30X-600P	BYC30W-600P	BYC30WT-600P		BYC30Y-600P			BYC30B-600P	
30	-	-	-			BYC30W-600PT2							
30	-	-	-										BYC30W-600PT2-A
60	1.55	60	40			BYC60W-600P							
75	1.6	75	42			BYC75W-600P							BYC75W-600PT2

1200V Planar Hyperfast Power Diodes

V _{RRM} (V)	I _{F(AV)} (A)	V _F (typ) @150C (V)	@ I _F (A)	t _{rr} (typ) @25C (ns)	SOD59 (TO220AC)	TO247-2L
1200V	5	2.0	5	42	BYC5-1200P	
	8	2.0	8	46	BYC8-1200P	
	15	2.0	15	61	BYC15-1200P	
	30	2.1	30	70	BYC30-1200P	BYC30W-1200P
	40	2.2	40	91		BYC40W-1200P
	40	-	-	-		BYC40W-1200PS
	60	2.2	60	96		BYC60W-1200P
	75	2.2	75	113		BYC75W-1200P
100	2.2	100	115		BYC100W-1200P	

In the Spotlight

1200V Planar Hyperfast Power Diodes

- Planar Passivated, Pt doping technology
- Fast recovery, System efficiency improvement
- Soft recovery, Reduce system EMI
- Avalanche ruggedness
- Reduces switching losses in associated MOSFET or IGBT



Power Diodes

Ultrafast Power Diodes

Types in **bold red italic** represent products in development

V _{RRM} (V)	I _{FMV} (A)	V _F (typ) @150C (V)		t _r (typ) @25C (ns)	SOD59 (TO220AC)	SOD113 (2-pin SOT186A)	SOT78 (TO220AB)	SOT186A (isolated TO220AB)	SOT223	SOT226 (I ² PAK)	SOT404 (D ² PAK)	SOT428 (DPAK)	SMA	SOD132 (SMB)	SMC	SOT1259 (TO-3P)	(TO-3PF)	TO247-2L	SOD142 (2-pin TO247)	SOT429 (3-pin TO247)		
		V _F (typ) @150C (V)	I _F (A)		BYW29E-100	BYW29E-150	BYW29E-200	BYW29E-200	BYW29E-200	BYW29E-200	BYW29E-200	BYW29E-200	BYW29E-200	BYW29E-200	MUR320	BYW29E-200	BYW29E-200	BYW29E-200	BYW29E-200	BYW29E-200	BYW29E-200	BYW29E-200
100	8	0.8	8	20																		
100	2x10	0.72	8	20			BYV32E-100															
150	2x0.75	0.5	0.5	10					BYV40E-150													
150	8	0.8	8	20	BYW29E-150																	
150	2x10	0.72	8	20			BYV32E-150															
150	2x15	0.78	15	20			BYV42E-150															
200	3	0.71	3	27																		
200	8	0.8	8	20	BYW29E-200	BYW29EX-200																
200	2x5	0.8	5	15			BYQ28E-200	BYQ28X-200														
200	2x5	0.8	5	15			BYQ28E-200E															
200	14	0.83	14	20	BYV79E-200																	
200	2x8	0.84	8	20			BYQ30E-200															
200	2x10	0.72	8	20			BYV32E-200P			BYV32G-200	BYV32EB-200P											
200	2x15	0.78	15	20			BYV42E-200			BYV42G-200	BYV42EB-200										BYV72EW-200	
							BYQ42E-200															BYQ72EW-200
300	2x5	0.95	5	50			BYT28-300															
300	2x10	0.81	10	9			BYV32E-300P	BYV32EX-300P														
300	2x30	0.85	30	33							BYV32EB-300P											
400	4	0.784	4	55																	BYV430W-300P	
400	9	0.9	8	50	BYV29-400																	
400	2x10	0.87	10	50			BYV34-400															
400	2x15	0.95	15	35																	BYV74W-400	
500	9	0.9	8	50	BYV29-500	BYV29X-500					BYV29B-500											
500	2x5	0.95	5	50			BYT28-500	BYT28X-500														
500	14	0.9	15	50	BYT79-500																	
500	2x10	0.87	10	50			BYV34-500															
500	2x15	0.95	15	50			BYV44-500															
600	1	0.88	1	45										MURS160	MURS160B							
600	3	0.88	3	36											MURS360B							
600	5	0.9	5	45												MUR560						
600	5	1.1	5	17.5	BYV25F-600	BYV25FX-600					BYV25FB-600	BYV25FD-600										
600	5	0.97	5	50						BYV25G-600		BYV25D-600										
600	8	1.07	8	60	BYR29-600	BYR29X-600																
600	8	0.8	8	65																	MUR860	
600	9	0.97	8	50	BYV29-600P	BYV29X-600P					BYV29G-600P	BYV29B-600P	BYV29D-600P									
600	9	1.25	8	17.5	BYV29F-600	BYV29FX-600					BYV29FB-600	BYV29FD-600										
600	10	1.6	10	20	BYV10-600P	BYV10X-600P																
600	10	1.6max	10	35		BYV10EX-600P															BYV10ED-600P	
600	15	1	15	50	BYT79-600																	
600	15	0.96	15	50		BYT79X-600P																
600	2x10	0.92	10	50			BYV34-600	BYV34X-600				BYV34G-600										
600	2x10	1.3	10	20			BYV410-600P	BYV410X-600P														
600	2x15	1.3	10	20																		
600	30	0.98	30	42	BYV30-600P	BYV30X-600P						BYV30B-600P									BYV415W-600P	
600	40	0.97	40	52																	BYV30W-600P	
600	2x30	1.25	30	53																	BYV40W-600P	
600	60	1.2	60	53																		
600	60	1.35	60	40																	BYV60W-600P	
600	75	-	-	-																		
800	8	1.07	8	60	BYR29-800																BYV75W-600PS	
800	8	1.2	8	40		BYR29X-800P																
1200	5	1.6	5	50								BYR5D-1200P										

Power Diode part numbering

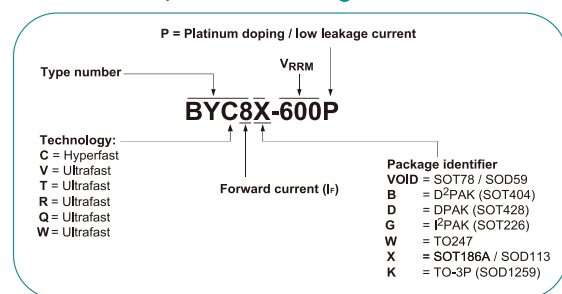

In the Spotlight



Ultrafast power diodes

- Fast switching
- High voltage capability
- Low forward voltage drop
- Low leakage current (platinum doped series)
- Low thermal resistance
- Soft recovery characteristic



SiC Schottky Diode

Types in **bold red italic** represent products in development

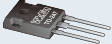
V_{RRM} (V)	$I_{F(AV)}$ (A)	V_F (typ) @25C (V)	$@ I_F$ (A)	Q_r (typ) @25C (nC)	SOD59 (TO220AC)	SOD113 (2-pin SOT186A)	SOD142 (2-pin TO247)	SOT429 (3-pin TO247)	SOT428 (DPAK)	SOT404 (D ² PAK)	DNF 8X8
											
650	4	1.5	4	7	NXPSC04650	NXPSC04650X			NXPSC04650D	NXPSC04650B	WNSC04650T
	6	1.5	6	10	NXPSC06650	NXPSC06650X			NXPSC06650D	NXPSC06650B	WNSC06650T
	8	1.5	8	13	NXPSC08650	NXPSC08650X			NXPSC08650D	NXPSC08650B	WNSC08650T
	10	1.65	10	12	NXPLQSC10650						
	10	1.5	10	15	NXPSC10650	NXPSC10650X			NXPSC10650D	NXPSC10650B	WNSC10650T
	12	1.5	12	20	NXPSC12650					NXPSC12650B	
	16	1.5	16	26	NXPSC16650					NXPSC16650B	
	20	1.5	20	28	NXPSC20650					<i>NXPSC20650B</i>	
	2 x 10	1.5	10	14				NXPSC20650W			
	2 x 10	1.65	10	11				NXPLQSC20650W			
	2 x 15	1.75	15	15				NXPLQSC30650W			
1200	2	1.4	2	-	WNSC021200						
	5	1.4	5	-	WNSC051200						
	10	1.4	10	-	WNSC101200						
	10	1.4	10	24			WNSC101200W				
	2 x 5	1.6	10	12				WNSC101200CW			
	20	1.4	20	52			WNSC201200W				
	2 x 10	1.4	20	24				WNSC201200CW			

In the Spotlight

650V SiC Schottky Diode

- Highly stable switching performance
- High forward surge capability IFSM
- Extremely fast reverse recovery time
- Superior in efficiency to Silicon Diode alternatives
- Reduced losses in associated MOSFET
- Reduced EMI
- Reduced cooling requirements
- RoHS compliant

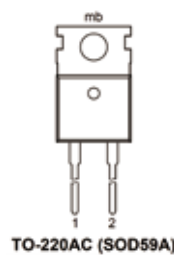

In the Spotlight





1200V SiC Schottky Diode

- Highly stable switching performance
- High forward surge capability IFSM
- Extremely fast reverse recovery time
- Superior in efficiency to Silicon Diode alternatives
- Reduced losses in associated MOSFET
- Reduced EMI
- Reduced cooling requirements
- RoHS compliant
- High junction operating temperature capability ($T_{j(max)} = 175\text{ °C}$)





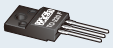

Power Schottky Diodes

Types in **bold red italic** represent products in development

V_{RRM} (V)	$I_{F(AV)}$ (A)	V_F (typ) @120C (V)	@ I_F per diode (A)	SOD78 (TO220AB)	SOD404 (D ² PAK)	SOT186A (isolated TO220AB)	TO262
							
100	2 x 10	0.73	10			WNS20S100CX	
	2 x 10	0.63	10	WNS20H100C	WNS20H100CB	<i>WNS20H100CX</i>	
	2 x 10	0.73	10	WNS20S100C	WNS20S100CB	<i>WNS20S100CX</i>	
	2 x 15	0.6	15	WNS30H100C	WNS30H100CB	<i>WNS30H100CX</i>	
	2 x 20	0.61	20	WNS40H100C	WNS40H100CB	<i>WNS40H100CX</i>	WNS40H100CG
	2 x 20	0.64	20	WNS40I100C			

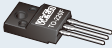
600V - 1600V Standard Power Diodes

Types in **bold red** represent new products
Types in **bold red italic** represent products in development

V_{RRM} (V)	$I_{F(AV)}$ (A)	V_F (typ) @150C (V)	@ I_F (A)	I_{FSM} @10ms (A)	SOT186A (isolated TO220AB)	TO247-2L	SOT428 (DPAK)	SOD132 (SMB)
								
600V	10	0.89@25C	10	-	WND10M600X			
800V	8	0.84	8	150			SK8D	
	10	1.07	10	-	WND10P08X			
1000V	3	1.15@25C	3	-				<i>WND03M10</i>
1600V	8	1.0	8	150	WND08P16X		WND08P16D	
	45	1	45	475		WND45P16W		
	60	1.08	60	-		WND60P16W		

Power Diode Bridge

Types in **bold red italic** represent products in development

V_{RRM} (V)	$I_{F(AV)}$ (A)	V_F (typ) @25C (V)	I_{FSM} @10ms (A)	GBU	GBJ
					
600V	15	0.88	-	<i>WNB15GU</i>	
600V	25	0.9	300		<i>WNB2560M</i>

Power Diode Module

employing series die technology for the lowest possible t_{rr}

V_{RRM} (V)	$I_{F(AV)}$ (A)	V_F (typ) @25C (V)	I_{FSM} @10ms (A)	WNN01
				
1600V	75	1.6 _{MAX}	750	WDMF75M16

In the Spotlight

WDMF75M16

- Three phase rectifiers
- Heat transfer through aluminium oxide DBC, ceramic isolated metal baseplate
- High voltage capability
- High inrush current capability
- Planar process
- High operating temperature capability ($T_{j(max)} = 150^{\circ}C$)

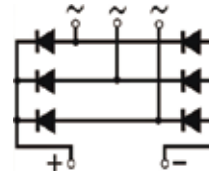

WeEn High Voltage 1600V SCRs

1600V/50A & 1600V/80A, Planar Passivated

Applications

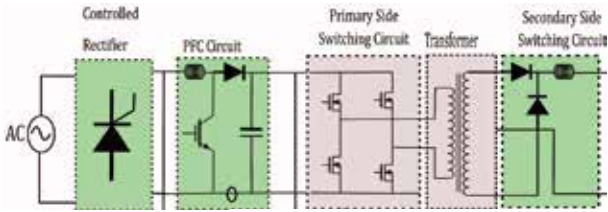

- Uninterruptible Power Supply (UPS)
- Solid State Relay (SSR)
- Battery Charger
- AC Motor control / DC motor control
- Lighting and temperature control



Key Features and Benefits

- Very High Voltage Block capability up to 1600V
- High junction operating temperature $T_{j(max)}=150^{\circ}C$
- Very high current surge capability
- Planar passivated for voltage ruggedness and reliability
- High thermal cycling performance
- Low forward voltage drop
- Enables the control of peak current at power supply switch-on, limits the use of mechanical relay to extend system life time

Key Parameters

Parameters	TYN50W-1600T	TYN80W-1600T
Package	TO-247	TO-247
$I_{T(AV)}$	50A	80A
$I_{T(RMS)}$	79A	126A
V_{DRM}	1600V	1600V
I_{GT}	80mA max	80mA max
I_{TSM}	650A @ 10ms	850A @ 10ms
$T_{j(max)}$	150°C	150°C
di_T/dt	150A/us	150A/us
dV_o/dt	1500V/us @150°C	1000V/us @150°C

Product

Product	Package
TYN50W-1600T	TO-247
TYN80W-1600T	TO-247

WeEn 30A Hi-Com™ Triacs

Applications



- Heating controls
- High power motor control
- High power AC power tools
- Applications subject to high temperature ($T_{j(max)} = 150^{\circ}\text{C}$)

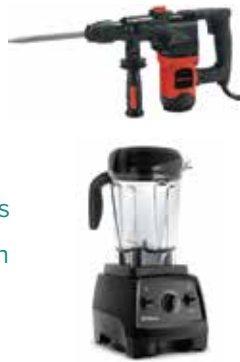

Key Features and Benefits

- Planar passivated 3Q Hi-Com™ technology
- High commutation capability with maximum false trigger immunity
- High junction operating temperature capability ($T_{j(max)} = 150^{\circ}\text{C}$)
- High Surge current capability & Low On-state voltage drop (Low V_T)
- High thermal cycling performance
- Internal insulated package (IITO220) provide best voltage isolation (2500V) & thermal dissipation balancing
- Surface mountable plastic package (D2PAK) gives the benefit of easy assembly
- Package is RoHS compliant





Product

Product	Package
BTA330-800BT	TO220
BTA330X-800BT	TO220FP
BTA330Y-800BT	IITO220
BTA330Y-800CT	IITO220
BTA330B-800BT	D ² PAK
BTA330B-800CT	D ² PAK

Key Parameters

Parameters	BTA330 BT series	BTA330 CT series
$I_{T(RMS)}$	30A	30A
V_{DRM}	800V	800V
I_{GT}	50mA max	35mA max
I_{TSM}	270A @ 20ms	270A @ 20ms
$T_{j(max)}$	150°C	150°C
di_t/dt	100A/μs	100A/μs

DFN 8x8 Package

Package Outline	D ² PAK	DFN 8X8	DFN 8X8 vs D ² PAK
			
L x W x H (mm ³)	10 x 11 x 4.4	8 x 8 x 0.85	
Footprint (mm ²)	110	64	-42%
Volume (mm ³)	484	54.4	-88%

Part No	V _{DC} (V)	I _F (A)	V _F (V) ¹⁾	I _{FSM} (A) ²⁾	C _d (pF) ³⁾	I _R (mA)
WN5C04650T	650	4	1.56	36	4	1.56
WN5C06650T	650	6	1.50	54	6	1.50
WN5C08650T	650	8	1.55	72	8	1.55
WN5C10650T	650	10	1.58	76	10	1.58

Applications

- Telecom / Server power
- Photovoltaic inverter

Features of DFN 8X8

- Surface Mount Package
- Package: height <1mm with light weight
- Low parasitic inductance due to “No-pin” design
- Thermal path through the metal pad to the PCB improves thermal performance

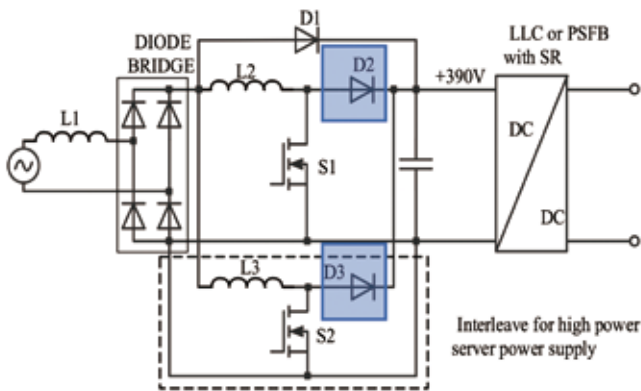

Telecom / Server power

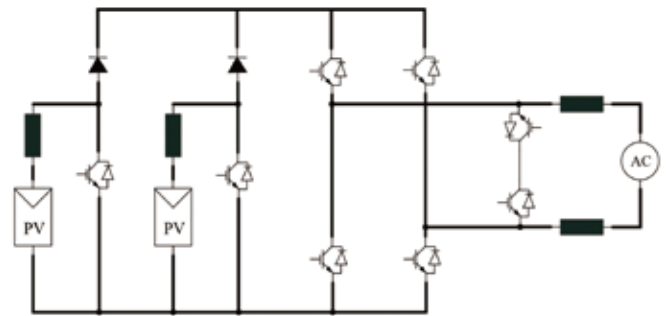

Photovoltaic inverter

WeEn Silicon Carbide Junction Barrier Schottky (JBS) 650V and 1200V Series

Voltage	Current	Package
650V	4-30A	TO220 / TO247 / DPAK / D ² PAK
1200V	2-40A	TO220 / TO247

Key features of WeEn SiC JBS
· No reverse recovery charge
· Qr temperature independent
· High thermal conductivity

WeEn SiC JBS for Server Power / Telecom Power

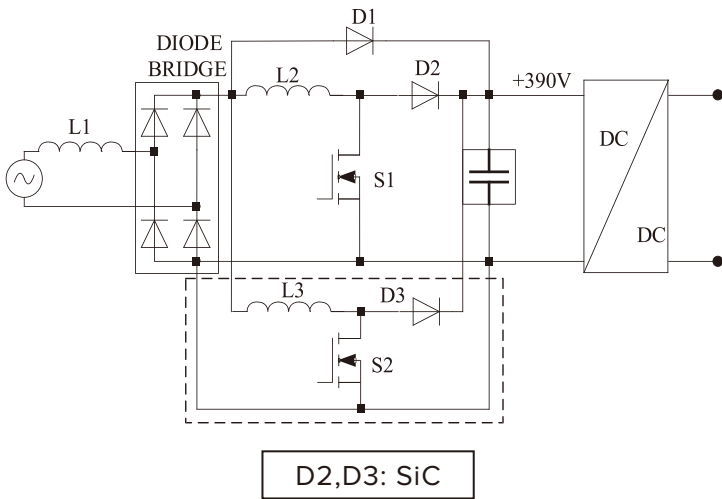

WeEn SiC JBS for Photovoltaic Inverter

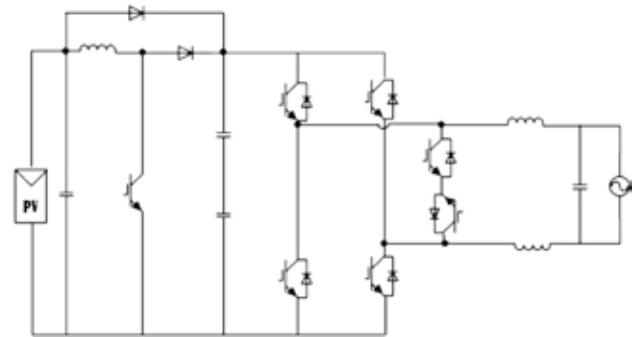

NXPSC10650	NXPSC20650W
NXPSC20650	NXPSC10650X

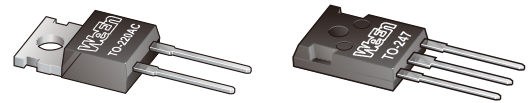

WeEn Products for EV On Board Charger

- Automotive Grade, AEC-Q101 qualified**
- Fast Switching Silicon Diodes $T_{j(max)} 175^{\circ}C$
 - High Efficiency Silicon Carbide Diodes $T_{j(max)} 175^{\circ}C$
 - High Current SCRs $T_{j(max)} 150^{\circ}C$

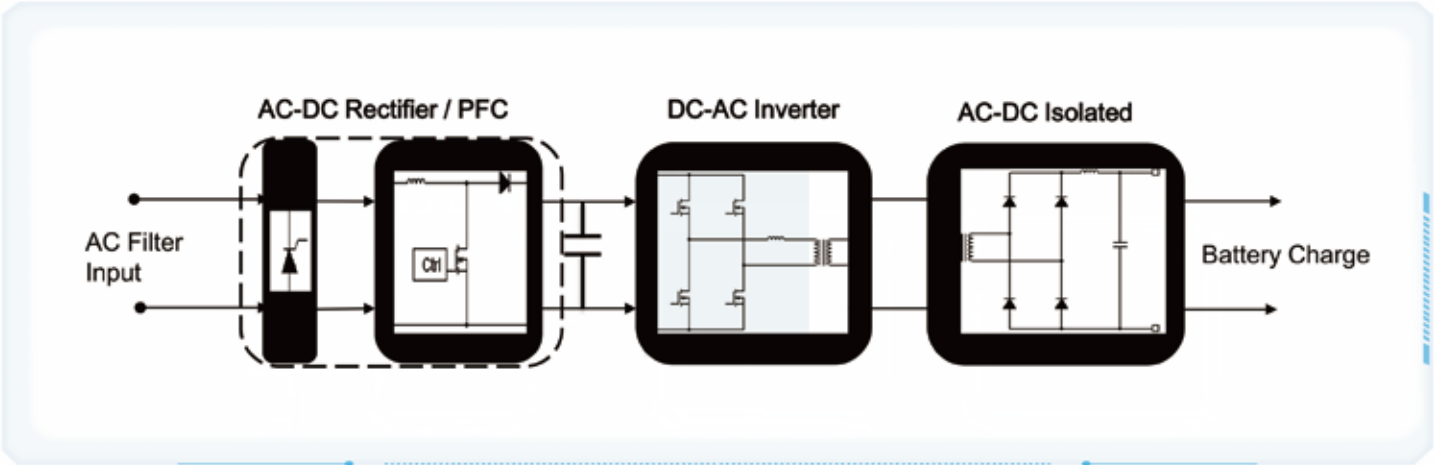

- NXPSC20650W-A
- BT155W-1200T-A
- BT153B-1200T-A
- BYC30W-600PT2-A**

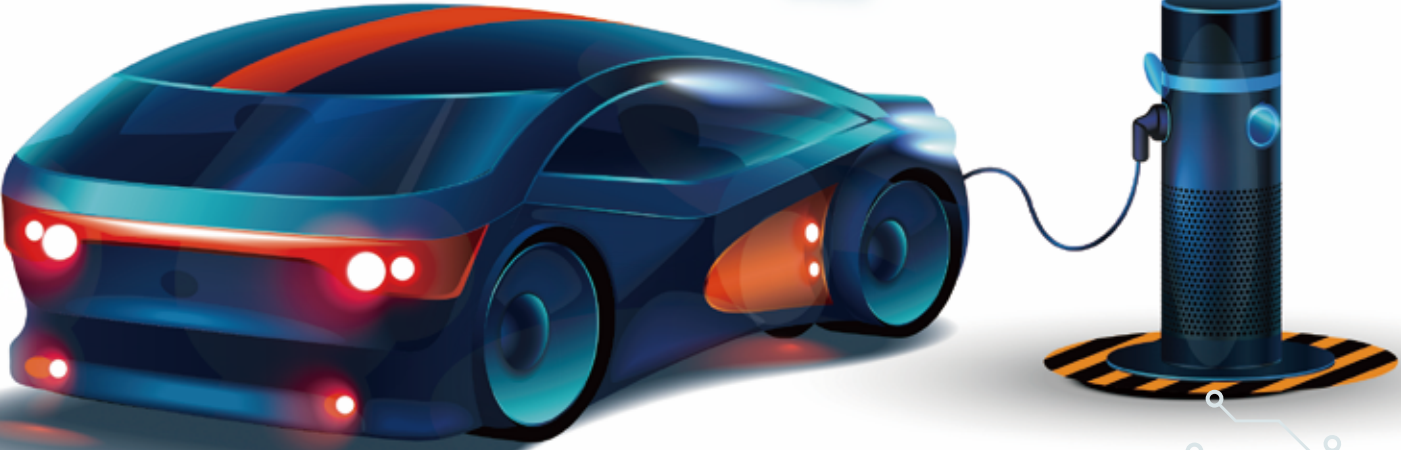
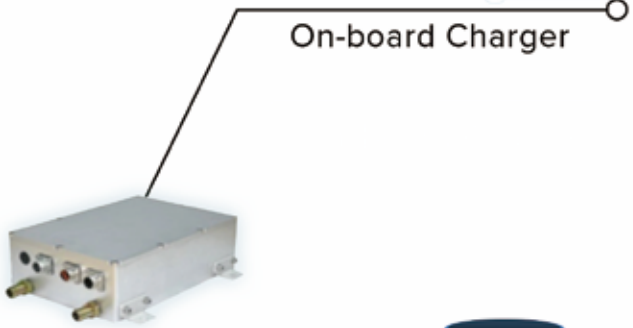

WeEn Products in Smart Home

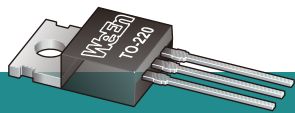

Coffee Machine:

- Planar passivated technology, high $T_{j(max)}$ 150 °C capability for better heating control
- BTA316Y-800CT used for heating element control
- TOPT16-800C0 used for heating element control with over temp. protection function embedded

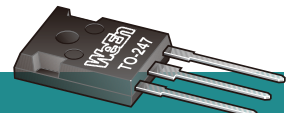

Air-con

- Platinum-doping SABER™ Series Fast Recovery Diodes
- BYV415W-600P, BYV415J-600P used for PFC
- BYV30JT-600P, BYC30W-600PT2, BYC20X-600P, BYC30X-600P used for traditional PFC

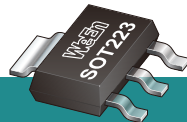

Wash Machine

- Planar Passivated technology with the best false trigger capability
- BTA201W-800E used for Valve control
- BTA416Y-800C used for drum motor control



Dish Washer

- Planar passivated ACT/ACTT series with over-voltage clamp function
- ACT108W-800E used for water inlet valve control
- ACTT4S-800E used for water extraction pump control



FIB&SEM&EDX



X-RAY



Tesec

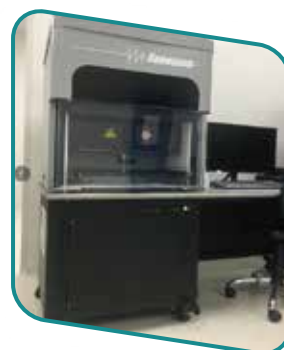

C-SAM



Temperature Cycle



UHASt & PPOT



Reverse bias tropical



ESD(HBM&MM)

Items of Reliability test & FA

可靠性试验及失效分析项目

Failure Analysis	失效分析	Reliability Test	可靠性测试
• Electrical	电测量	• HBM/MM	静电测试
• I-V Curve	I-V曲线	• High temperature storage	高温储存试验
• CSAM	超声波扫描	• Low temperature storage	低温储存试验
• Microscope	高低倍显微镜 (外观检查)	• Temperature cycle (Air to Air)	温度循环试验 (气体式)
• SEM / EDX / FIB	扫描电镜成像/能谱/聚焦离子束成像	• High temperature reverse bias	高温反偏试验
• Fault Isolation	失效定位	• Gate voltage test	高温栅偏偏试验
• Surface Texture	表面纹理	• Reverse bias tropical	高温高湿反偏试验
• X-Ray	X射线成像	• Thermal fatigue	热疲劳试验
• Chemical Decap	化学开封	• Unbiased highly accelerated stress test	高加速老化试验
• Laser Decap	镭射开封	• Highly accelerated stress test	高温高湿高压反偏测试

2020 WeEn Semiconductors

All rights reserved. Reproduction in whole or in part is prohibited without the prior written consent of the copyright owner. The information presented in this document does not form part of any quotation or contract, is believed to be accurate and reliable and may be changed without notice. No liability will be accepted by the publisher for any consequence of its use. Publication thereof does not convey nor imply any license under patent- or other industrial or intellectual property rights.

Date of release: July 2020

Document order number: 20200701



Website: www.ween-semi.com

Mailbox: marcom@ween-semi.com

X-ON Electronics

Largest Supplier of Electrical and Electronic Components

Click to view similar products for [Diodes - General Purpose, Power, Switching category:](#)

Click to view products by [WeEn Semiconductor manufacturer:](#)

Other Similar products are found below :

[MMBD3004S-13-F](#) [1N3611](#) [NTE156A](#) [NTE6244](#) [1SS400CST2RA](#) [SDAA13](#) [SHN2D02FUTW1T1G](#) [1N4449](#) [1N456A](#) [1N914BTR](#)
[D291S45T](#) [BAS 16-02L E6327](#) [BAS 16-02V H6327](#) [BAS 21U E6327](#) [BAS 28 E6327](#) [BAW56DWQ-7-F](#) [BAW75-TAP](#) [MM230L-CAA](#)
[IDW40E65D1](#) [JAN1N3600](#) [JAN1N4454UR-1](#) [SMMSD4148T3G](#) [BYW95B/A52A](#) [NSVDAN222T1G](#) [CDSZC01100-HF](#) [BAV70HDW-7](#)
[BAS28-7](#) [JANTX1N6640](#) [BAW56HDW-13](#) [BAS28 TR](#) [VS-HFA04SD60STR-M3](#) [1SS388-TP](#) [BAV99TQ-13-F](#) [BAV99HDW-13](#) [1N4004](#)
[MMDB30-E28X](#) [LS4148](#) [IDV15E65D2](#) [W0503RH200S0L](#) [M0268SJ200NLF](#) [M0268RJ200NLF](#) [S3MBF](#) [US1J](#) [DAN217U-TP](#) [SHV-06JNS-](#)
[Q](#) [IDW30C65D1](#) [IDW80C65D1](#) [VS-HFA30TA60CSR-M3](#) [M1MA152WAT1](#) [MMSD71RKT1G](#)