



WEICON TOOLS®

No.1 in Form & Funktion

Catalogue 



STRIPPING TOOLS



reddot winner 2020



Download Now

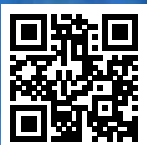

www.weicon.com/app



www.weicon-tools.com

V 1.21



Management System
ISO 9001:2015
ISO 14001:2015

www.tuv.com
ID 9108636595



**FAMILY BUSINESS
SINCE 1947**

We develop, produce and distribute an extensive range of stripping tools. This includes cable knives, wire strippers, dismantling and multi-functional tools. Our tools have been developed for accurate, fast and safe stripping of all common cable types. They carry the GS seal of TÜV Nord and were developed under the aspects of work safety. The tools are specifically tailored to the needs of professional users, are found in both, crafts and industrial use, and are also suitable for domestic use.

Besides the WEICON TOOLS, WEICON produces special chemo-technical products for the industry. The product range of the company includes special adhesives and sealants, technical sprays as well as high performance assembly pastes and greases for all areas of industry - from the production, repair and maintenance to servicing.

The company headquarters are located in Muenster, Germany. WEICON has subsidiaries in Dubai, Canada, Turkey, Romania, South Africa, Singapore, the Czech Republic, Spain and in Italy and is represented by WEICON partners in more than 120 countries all over the world.



Fast and individual service



Strong sales support



Next day delivery



Management System
ISO 9001:2015
ISO 14001:2015
www.tuv.com
ID 9108636595



Member of the Association of German Tool Manufacturers



For more information on all WEICON products, visit www.weicon.com

Content

| Content | Page |
|--------------------------------------------|------|
| WEICON TOOLS..... | 4 |
| Cable Strippers | 6 |
| • S 4 - 28..... | 7 |
| • S 4 - 28 Multi..... | 7 |
| • C 4 - 16..... | 9 |
| • C 8 - 27..... | 9 |
| • C 4 - 28..... | 9 |
| • No. 4 - 16..... | 9 |
| • No. 8 - 27..... | 9 |
| • No. 4 - 28 H..... | 9 |
| • No. 4 - 28 G..... | 9 |
| • No. 28 - 35..... | 9 |
| • No. 35 - 50..... | 9 |
| Wire Strippers | 10 |
| • No. 5..... | 10 |
| • No. 5 Classic..... | 11 |
| • No. 6..... | 11 |
| • No. 7 Magic..... | 12 |
| • No. 7 F..... | 13 |
| • Precision Wire Stripper S..... | 14 |
| • ESD Precision Wire Stripper..... | 15 |
| • Fibre Optic Stripper..... | 15 |
| Stripping Tools | 16 |
| • Round Cable Stripper No. 13..... | 16 |
| • Round Cable Stripper No. 13 Classic..... | 16 |
| • Quadro-Stripper No. 16..... | 17 |
| • Coax-Stripper No. 1 F Plus..... | 18 |
| • Coax-Stripper No. 2..... | 19 |
| • Combi-Coax No. 3..... | 19 |
| • Cat Cable-Stripper No. 10..... | 20 |
| • Stripper No. 2 Cat..... | 21 |
| Multi-Purpose Strippers | 22 |
| • Mini-Duo No. 150..... | 22 |
| • Duo-Stripper No. 200..... | 22 |
| • Duo-Crimp No. 300..... | 23 |
| • Multi-Stripper No. 400..... | 24 |
| • Data-Strip No. 30..... | 25 |
| • Stripper No. 100..... | 25 |
| Tool Sets | 26 |
| • Starter-Set Pro..... | 26 |
| • Crimp-Set Pro..... | 27 |
| • Electrical Installation Sets..... | 28 |
| Special Tools | 30 |
| • Mini-Solar No. 3..... | 30 |
| • Wire Stripper No. 7 Solar..... | 30 |
| • Cable Scissors No. 35..... | 31 |
| • LSA Sensor No. 40..... | 31 |
| • H.D. No. 1000..... | 32 |
| • Dismantling Tool No. 25..... | 32 |
| • Cable Stripper No. 4 - 29 Spiral..... | 32 |
| • Easy Opener®..... | 33 |
| • Multi-Opener..... | 33 |
| Other | 34 |
| • Spare Parts..... | 34 |
| • Selling Aids..... | 35 |
| • Cable Overview..... | 36 |
| • Application Examples..... | 38 |
| • Certificates..... | 40 |
| • Stripping Tools for Private Label..... | 41 |
| • Product Overview..... | 42 |



Scan your way to the video!

You will find QR codes on our product pages that lead directly to our application videos!

With kind support from



WEICON TOOLS®



Member of the German Tool Industry Association



We develop, manufacture and distribute high-quality wire stripping and other special tools for the industry and professional users and can look back on almost 50 years of success by now.

We present these tools at more than 40 fairs and trade shows every year, all over the world. We keep in constant contact with our users, who tell us about new developments in their work processes and, that way, give us ideas and requests for new or improved WEICON TOOLS. This exchange of information generates a process that regularly results in product innovations and modifications and therefore enables us to constantly offer our customers the perfectly engineered and up-to-date solutions they need.



Discover our WEICON TOOLS®



We produce **SUSTAINABLY!**

Quality and continuity "made in Germany"
INNOVATIVE AND RELIABLE!



Since the beginning of 2020, we have been packaging our WEICON TOOLS products in recyclable cardboard boxes. These will come in three different sizes in the future to protect all tools produced by our Muenster-based family business.



reddot winner 2020



In the development of our high-quality stripping tools, we have been working together with the company Krampe from Ascheberg-Herbern near Muenster since 1990.

Our consistent key focus in the production process is on precision to ensure that the products we offer are always of exceptional quality.

Our products are made of high-quality materials, hold numerous certificates and are characterised by their outstanding functionality and durability.



Discover our
WEICON TOOLS®



Cable Strippers S 4 - 28

- ▶ completely ergonomic & fully insulated
- ▶ continuous regulation and easy to operate adjusting wheel
- ▶ precise, quick and safe stripping



EU.Pat.no. 07114242.6

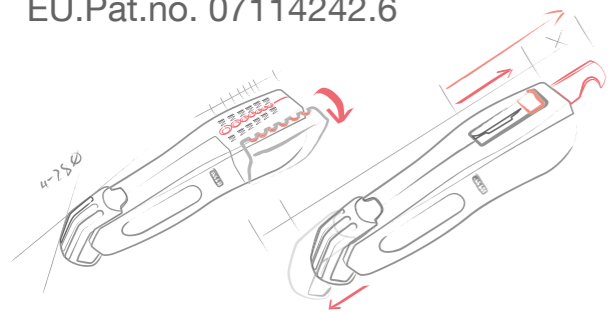

**Working range
4 - 28 mm Ø**

“ Our S4 - 28 range is certainly something special. There are no other comparable tools on the market. The right cable stripper can be found for almost any application area thanks to the different types.

Its extraordinary shape ensures a safe and comfortable grip. Furthermore, the retractable blade of the S 4 - 28 is a milestone in the area of safety at work.

Gerold Specking
Product Manager
WEICON TOOLS

“

No. S 4 - 28 Multi

Stripping function integrated in the housing

- ▶ stripping of all standard flexible and solid cables with a cross-diameter between 0,5 and 6 mm²

| mm | g | mm ² | Ømm | Art.-No. |
|-----|----|--------------------------|--------|----------|
| 145 | 61 | 0,5 - 6 (20 - 10 AWG) | 4 - 28 | 50057328 |



No. S 4 - 28

Safe due to retractable hook blade

- ▶ the blade can be locked in both positions

| mm | g | mm ² | Ømm | Art.-No. |
|-----|----|-----------------|--------|----------|
| 145 | 72 | - | 4 - 28 | 50055328 |



Cable Strippers 4 - 28

- ▶ completely ergonomic & fully insulated
- ▶ continuous regulation and easy to operate adjusting wheel
- ▶ precise, quick and safe stripping

Discover our
WEICON TOOLS®

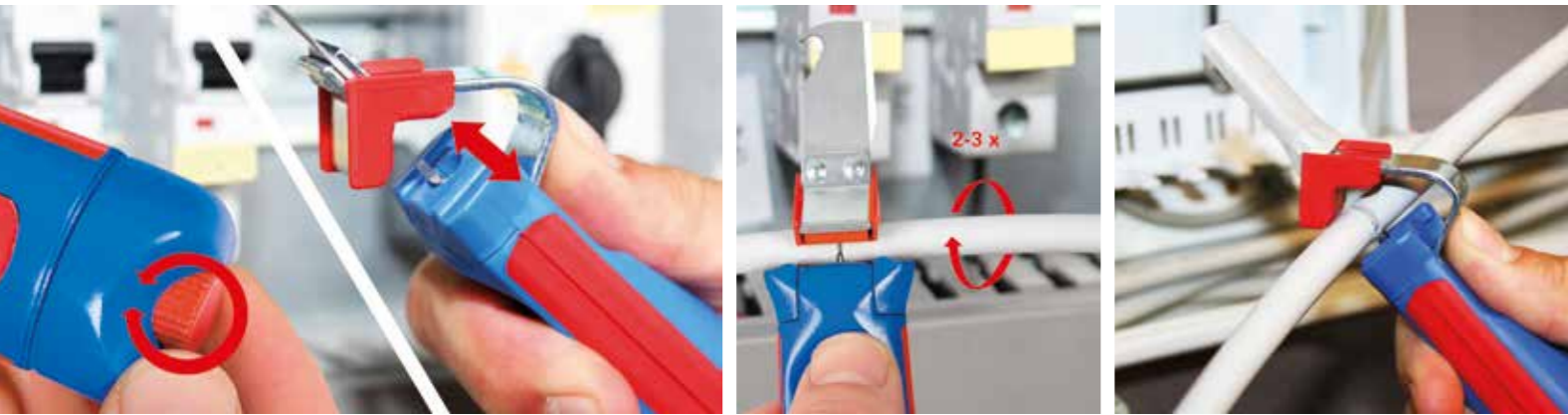

- ① Setting screw
- ② Inner blade
- ③ Bracket with or without blade
- ④ POM part
- ⑤ Cap (on cable stripper with blade)
- ⑥ Outer casing with anti-slip 2-component handle
- ⑦ Closure cap

Cable Strippers

| | mm | g | Ømm | Art.-No. |
|-------------------|-----|----|--------|----------|
| No. 4 - 16 | 140 | 84 | 4 - 16 | 50050116 |



| | | | | |
|-------------------|-----|----|--------|----------|
| No. 8 - 27 | 140 | 92 | 8 - 28 | 50050227 |
|-------------------|-----|----|--------|----------|

| | mm | g | Ømm | Art.-No. |
|---------------------|-----|----|---------------------------|----------|
| No. 4 - 28 H | 185 | 98 | 4 - 28 with hook blade | 50054328 |



| | mm | g | Ømm | Art.-No. |
|---------------------|-----|-----|-------------------------------|----------|
| No. 4 - 28 G | 195 | 104 | 4 - 28 with straight blade | 50054428 |



| | mm | g | Ømm | Art.-No. |
|--------------------|-----|----|---------|----------|
| No. 28 - 35 | 170 | 87 | 28 - 35 | 50050435 |



| | | | | |
|--------------------|-----|----|---------|----------|
| No. 35 - 50 | 180 | 90 | 35 - 50 | 50050450 |
|--------------------|-----|----|---------|----------|



Cable Strippers

| | mm | g | Ømm | Art.-No. |
|---------------------|-----|----|--------|----------|
| No. C 4 - 16 | 135 | 67 | 4 - 16 | 50053116 |



| | | | | |
|---------------------|-----|----|--------|----------|
| No. C 8 - 27 | 135 | 69 | 8 - 28 | 50053227 |
|---------------------|-----|----|--------|----------|

| | | | | |
|---------------------|-----|----|---------------------------|----------|
| No. C 4 - 28 | 180 | 80 | 4 - 28 with hook blade | 50053328 |
|---------------------|-----|----|---------------------------|----------|





Wire Strippers

Automatic wire strippers for all common stranded and solid conductors. A scanning system adjusts automatically to the required wire diameter, and thus permits fast and simple dismantling and stripping.

Discover our
WEICON TOOLS®



Our Bestseller

No. 5

Space-saving thanks to locking mechanism

- ▶ automatic wire stripper
- ▶ precise work with adjustable length stop (5 - 12 mm)
- ▶ integrated, well accessible side cutter up to 2 mm Ø

| mm | g | mm² | Ømm | Art.-No. |
|-----|-----|--------------------------|-----|----------|
| 170 | 107 | 0,2 - 6 (24 - 10 AWG) | | 51000005 |

selbst ist der Mann
Das Do-it-yourself-Magazin

PRAXISTEST
Kategorie: Ader-Abisolier-Werkzeuge
SEHR GUT (1,3)
2 Produkte mit SEHR GUT

TESTSIEGER
Ausgabe 04/2018
11 Produkte im Test
www.selbst.de



No. 5 Classic

| mm | g | mm² | Ømm | Art.-No. |
|-----|-----|--------------------------|-----|----------|
| 170 | 107 | 0,2 - 6 (24 - 10 AWG) | | 51003005 |



No. 6

1000 V
IEC: 60900

Working with voltage up to 1000 Volt*
Unit testing according to DIN EN 60900

- ▶ fully insulated, automatic wire stripper
- ▶ precise work with adjustable length stop (5 - 12 mm)
- ▶ space-saving thanks to locking mechanism

| mm | g | mm² | Ømm | Art.-No. |
|-----|-----|--------------------------|-----|----------|
| 170 | 105 | 0,2 - 6 (24 - 10 AWG) | - | 51000006 |



* Tools with safety insulation are basic prerequisites for working on live wires and parts. Please always pay attention to the legal regulations and follow the corresponding safety advice!

Working Range Wire Strippers:

| Outside diameter in mm | 0,1270 | 0,1430 | 0,1600 | 0,1800 | 0,2020 | 0,2270 | 0,2550 | 0,2860 | 0,3210 | 0,3610 | 0,4050 | 0,4550 | 0,5110 | 0,5730 | 0,6440 | 0,7220 | 0,8120 | 0,9120 | 1,0240 | 1,15 | 1,29 | 1,45 | 1,63 | 1,83 | 2,05 | 2,30 | 2,59 | 2,91 | 3,26 | 3,67 | 4,11 | 4,62 | 5,19 | 5,83 | 6,54 | 7,35 | 8,25 | | | | | |
|-----------------------------|--------|--------|--------|--------|--------|--------|--------|--------|--------|--------|--------|--------|--------|--------|--------|--------|--------|--------|--------|------|------|------|------|------|------|------|------|------|------|------|------|------|------|------|------|------|------|--|--|--|--|--|
| Cross section in mm² | 0,0123 | 0,0161 | 0,0200 | 0,0252 | 0,0320 | 0,0400 | 0,0503 | 0,0646 | 0,0804 | 0,1020 | 0,1280 | 0,1630 | 0,2050 | 0,2590 | 0,3240 | 0,4120 | 0,5190 | 0,6530 | 0,8230 | 1,04 | 1,31 | 1,65 | 2,08 | 2,63 | 3,31 | 4,15 | 5,26 | 6,62 | 8,34 | 10,6 | 13,3 | 16,8 | 21,2 | 26,7 | 33,6 | 42,4 | 53,4 | | | | | |
| AWG number | 36 | 35 | 34 | 33 | 32 | 31 | 30 | 29 | 28 | 27 | 26 | 25 | 24 | 23 | 22 | 21 | 20 | 19 | 18 | 17 | 16 | 15 | 14 | 13 | 12 | 11 | 10 | 9 | 8 | 7 | 6 | 5 | 4 | 3 | 2 | 1 | 0 | | | | | |
| Wire Stripper No. 5 | | | | | | | | | | | | | | | | | | | | | | | | | | | | | | | | | | | | | | | | | | |
| Wire Stripper No. 5 Classic | | | | | | | | | | | | | | | | | | | | | | | | | | | | | | | | | | | | | | | | | | |
| Wire Stripper No. 6 | | | | | | | | | | | | | | | | | | | | | | | | | | | | | | | | | | | | | | | | | | |
| Wire Stripper No. 7-Magic | | | | | | | | | | | | | | | | | | | | | | | | | | | | | | | | | | | | | | | | | | |
| Wire Stripper No. 7-F | | | | | | | | | | | | | | | | | | | | | | | | | | | | | | | | | | | | | | | | | | |
| Precision Wire Stripper S | | | | | | | | | | | | | | | | | | | | | | | | | | | | | | | | | | | | | | | | | | |
| ESD Precision Wire Stripper | | | | | | | | | | | | | | | | | | | | | | | | | | | | | | | | | | | | | | | | | | |
| Fibre Optic Stripper | | | | | | | | | | | | | | | | | | | | | | | | | | | | | | | | | | | | | | | | | | |

Wire Strippers

Automatic wire strippers for all common stranded and solid conductors. A scanning system adjusts automatically to the required wire diameter, and thus permits fast and simple dismantling and stripping.

Discover our
WEICON TOOLS®



No. 7 Magic

The all-rounder for stripping and dismantling
Pat.no. EP 1 671 407 B1

- ▶ for many different cable types in building installation
- ▶ precise work with optical length scale
- ▶ integrated, well accessible side cutter up to 3 mm Ø

| mm | g | Round cables | mm ² | Art.-No. |
|-----|-----|--------------|-----------------------|----------|
| 170 | 217 | flexible | 0,5 - 16 (20 - 6 AWG) | 51000007 |
| | | solid | 0,5 - 10 (20 - 8 AWG) | |



VIDEO



No. 7-F

Stripping and dismantling of all standard flat cables
Pat.no. EP 1 671 407 B1

- ▶ precise work with optical length scale
- ▶ integrated, well accessible side cutter up to 3 mm Ø

| mm | g | mm ² | Art.-No. |
|-----|-----|------------------------------------------|----------|
| 170 | 220 | flat cables 0,75 - 4 (18 - 11 AWG) | 51001007 |



Working Range Wire Strippers:

| Outside diameter in mm | 0,1270 | 0,1430 | 0,1600 | 0,1800 | 0,2020 | 0,2270 | 0,2550 | 0,2860 | 0,3210 | 0,3610 | 0,4050 | 0,4550 | 0,5110 | 0,5730 | 0,6440 | 0,7230 | 0,8120 | 0,9120 | 1,0240 | 1,15 | 1,29 | 1,45 | 1,63 | 1,83 | 2,05 | 2,30 | 2,59 | 2,91 | 3,26 | 3,67 | 4,11 | 4,62 | 5,19 | 5,83 | 6,54 | 7,35 | 8,25 | | | | |
|----------------------------------|--------|--------|--------|--------|--------|--------|--------|--------|--------|--------|--------|--------|--------|--------|--------|--------|--------|--------|--------|------|------|------|------|------|------|------|------|------|------|------|------|------|------|------|------|------|------|--|--|--|--|
| Cross section in mm ² | 0,0123 | 0,0161 | 0,0200 | 0,0252 | 0,0320 | 0,0400 | 0,0503 | 0,0646 | 0,0804 | 0,1020 | 0,1280 | 0,1630 | 0,2050 | 0,2590 | 0,3240 | 0,4120 | 0,5190 | 0,6530 | 0,8230 | 1,04 | 1,31 | 1,65 | 2,08 | 2,63 | 3,31 | 4,15 | 5,26 | 6,62 | 8,34 | 10,6 | 13,3 | 16,8 | 21,2 | 26,7 | 33,6 | 42,4 | 53,4 | | | | |
| AWG number | 36 | 35 | 34 | 33 | 32 | 31 | 30 | 29 | 28 | 27 | 26 | 25 | 24 | 23 | 22 | 21 | 20 | 19 | 18 | 17 | 16 | 15 | 14 | 13 | 12 | 11 | 10 | 9 | 8 | 7 | 6 | 5 | 4 | 3 | 2 | 1 | 0 | | | | |
| Wire Stripper No. 5 | | | | | | | | | | | | | | | | | | | | | | | | | | | | | | | | | | | | | | | | | |
| Wire Stripper No. 5 Classic | | | | | | | | | | | | | | | | | | | | | | | | | | | | | | | | | | | | | | | | | |
| Wire Stripper No. 6 | | | | | | | | | | | | | | | | | | | | | | | | | | | | | | | | | | | | | | | | | |
| flexible | | | | | | | | | | | | | | | | | | | | | | | | | | | | | | | | | | | | | | | | | |
| Wire Stripper No. 7 Magic | | | | | | | | | | | | | | | | | | | | | | | | | | | | | | | | | | | | | | | | | |
| solid | | | | | | | | | | | | | | | | | | | | | | | | | | | | | | | | | | | | | | | | | |
| outer sheath | | | | | | | | | | | | | | | | | | | | | | | | | | | | | | | | | | | | | | | | | |
| Wire Stripper No. 7-F | | | | | | | | | | | | | | | | | | | | | | | | | | | | | | | | | | | | | | | | | |
| Precision Wire Stripper S | | | | | | | | | | | | | | | | | | | | | | | | | | | | | | | | | | | | | | | | | |
| ESD Precision Wire Stripper | | | | | | | | | | | | | | | | | | | | | | | | | | | | | | | | | | | | | | | | | |
| Fibre Optic Stripper | | | | | | | | | | | | | | | | | | | | | | | | | | | | | | | | | | | | | | | | | |

Wire Strippers

Automatic wire strippers for all common stranded and solid conductors. A scanning system adjusts automatically to the required wire diameter, and thus permits fast and simple dismantling and stripping.

Discover our
WEICON TOOLS



Global innovation



reddot winner 2020



DBGM 20 2019 107 281.4

Precision Wire Stripper S

Fast, easy and precise stripping of thin wires and conductors

- ▶ stripping range from 0,12 mm - 0,8 mm (36 - 20 AWG)
- ▶ scanning system adjusts automatically to the required wire diameter
- ▶ precise working thanks to adjustable length stop from 5 - 45 mm
- ▶ professional stripping technology, suitable for right- and left-handed users



| mm | g | Round cables | Ø | Art.-No. |
|-----|----|-------------------|--------------------------------------|----------|
| 112 | 45 | flexible solid | 0,12 mm - 0,8 mm 0,12 mm - 0,8 mm | 5100002 |



ESD Precision Wire Stripper **NEW**



Fast and easy removal of wires and conductors

- ▶ for working in electrostatic protected areas (ESD safe workspace/ ESD protected area)
- ▶ the tool complies with the DIN EN 61340-5-1 standard
- ▶ stripping range from 0,12 - 0,8 mm (36 - 20 AWG)
- ▶ scanning system adjusts automatically to the required conductor cross section
- ▶ precise working thanks to adjustable length stop from 5 - 45 mm
- ▶ professional cable stripping technology
- ▶ suitable for right- and left-handed users

| mm | g | Round cables | Ø | Art.-No. |
|-----|----|-------------------|--------------------------------------|----------|
| 112 | 45 | flexible solid | 0,12 mm - 0,8 mm 0,12 mm - 0,8 mm | 51001002 |

ESD = dissipative ESD material protects against electrostatic discharge



Fibre Optic Stripper **NEW**

Fast and easy stripping of fibre optic primary coatings 200 - 250 µm

- ▶ for removing the primary coating on fibre optic cables Ø 0,125 mm
- ▶ blade Ø 0,16 mm, opening for cable insertion Ø 0,35 mm
- ▶ precise working thanks to adjustable length stop from 5 - 45 mm
- ▶ professional cable stripping technology
- ▶ suitable for right- and left-handed users



| mm | g | Cable type | Ø | Art.-No. |
|-----|----|---------------------------|---------------------------------------|----------|
| 112 | 45 | fibre optic Ø 0,125 mm | primary coating Ø 0,200 - 0,250 mm | 51002002 |

LWL primary coating
Ø 0,200 - 0,250 mm
(200 - 250 µm)

fibre optic
Ø 0,125 mm (125 µm)

Working Range Wire Strippers:

| Outside diameter in mm | 0,1270 | 0,1430 | 0,1600 | 0,1800 | 0,2020 | 0,2270 | 0,2550 | 0,2860 | 0,3210 | 0,3610 | 0,4050 | 0,4550 | 0,5110 | 0,5730 | 0,6440 | 0,7220 | 0,8120 | 0,9120 | 1,0240 | 1,15 | 1,29 | 1,45 | 1,63 | 1,83 | 2,05 | 2,30 | 2,59 | 2,91 | 3,26 | 3,67 | 4,11 | 4,62 | 5,19 | 5,83 | 6,54 | 7,35 | 8,25 | | | | |
|-----------------------------|--------|--------|--------|--------|--------|--------|--------|--------|--------|--------|--------|--------|--------|--------|--------|--------|--------|--------|--------|------|------|------|------|------|------|------|------|------|------|------|------|------|------|------|------|------|------|--|--|--|--|
| Cross section in mm² | 0,0123 | 0,0161 | 0,0200 | 0,0252 | 0,0320 | 0,0400 | 0,0503 | 0,0646 | 0,0804 | 0,1020 | 0,1280 | 0,1630 | 0,2050 | 0,2590 | 0,3240 | 0,4120 | 0,5190 | 0,6530 | 0,8230 | 1,04 | 1,31 | 1,65 | 2,08 | 2,63 | 3,31 | 4,15 | 5,26 | 6,62 | 8,34 | 10,6 | 13,3 | 16,8 | 21,2 | 26,7 | 33,6 | 42,4 | 53,4 | | | | |
| AWG number | 36 | 35 | 34 | 33 | 32 | 31 | 30 | 29 | 28 | 27 | 26 | 25 | 24 | 23 | 22 | 21 | 20 | 19 | 18 | 17 | 16 | 15 | 14 | 13 | 12 | 11 | 10 | 9 | 8 | 7 | 6 | 5 | 4 | 3 | 2 | 1 | 0 | | | | |
| Wire Stripper No. 5 | | | | | | | | | | | | | | | | | | | | | | | | | | | | | | | | | | | | | | | | | |
| Wire Stripper No. 5 Classic | | | | | | | | | | | | | | | | | | | | | | | | | | | | | | | | | | | | | | | | | |
| Wire Stripper No. 6 | | | | | | | | | | | | | | | | | | | | | | | | | | | | | | | | | | | | | | | | | |
| flexible | | | | | | | | | | | | | | | | | | | | | | | | | | | | | | | | | | | | | | | | | |
| Wire Stripper No. 7 Magic | | | | | | | | | | | | | | | | | | | | | | | | | | | | | | | | | | | | | | | | | |
| solid | | | | | | | | | | | | | | | | | | | | | | | | | | | | | | | | | | | | | | | | | |
| outer sheath | | | | | | | | | | | | | | | | | | | | | | | | | | | | | | | | | | | | | | | | | |
| Wire Stripper No. 7-F | | | | | | | | | | | | | | | | | | | | | | | | | | | | | | | | | | | | | | | | | |
| Precision Wire Stripper S | | | | | | | | | | | | | | | | | | | | | | | | | | | | | | | | | | | | | | | | | |
| ESD Precision Wire Stripper | | | | | | | | | | | | | | | | | | | | | | | | | | | | | | | | | | | | | | | | | |
| Fibre Optic Stripper | | | | | | | | | | | | | | | | | | | | | | | | | | | | | | | | | | | | | | | | | |

Stripping Tools

Our stripping tools enable the safe and convenient stripping of a range of different cable types.

The flexible tools can even be used in areas difficult to access and always provide precise results.

Round Cable Stripper No. 13

Safe work with the ergonomic anti-slip handle shape

- ▶ for all standard round cables
- ▶ flush stripping, even in hard-to-reach areas
- ▶ it is not necessary to adjust the cutting depth

| mm | g | mm ² | Ømm | Art.-No. |
|-----|----|-----------------|--------|----------|
| 140 | 48 | - | 6 - 13 | 52000013 |



Now with
length stop

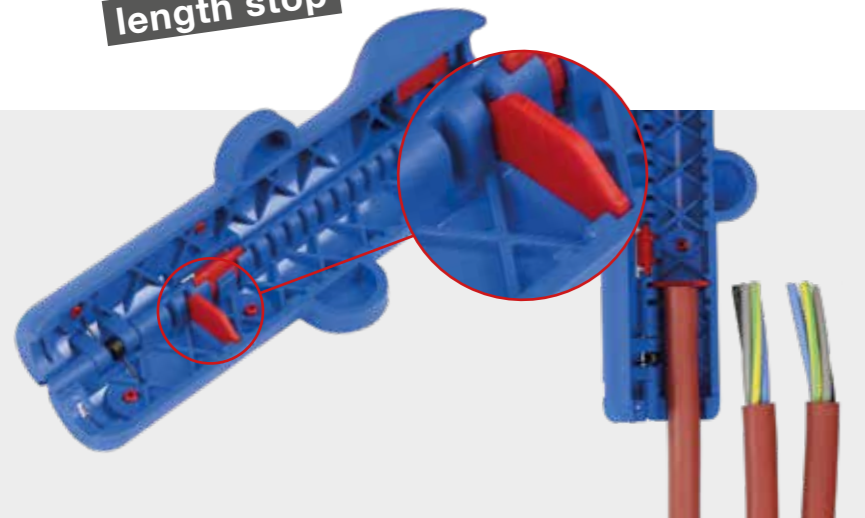

Round Cable Stripper No. 13 Classic

Safe work with the ergonomic anti-slip handle shape

- ▶ for all standard round cables
- ▶ flush stripping, even in hard-to-reach areas
- ▶ it is not necessary to adjust the cutting depth

| mm | g | mm ² | Ømm | Art.-No. |
|-----|----|-----------------|--------|----------|
| 120 | 44 | - | 8 - 13 | 52003013 |

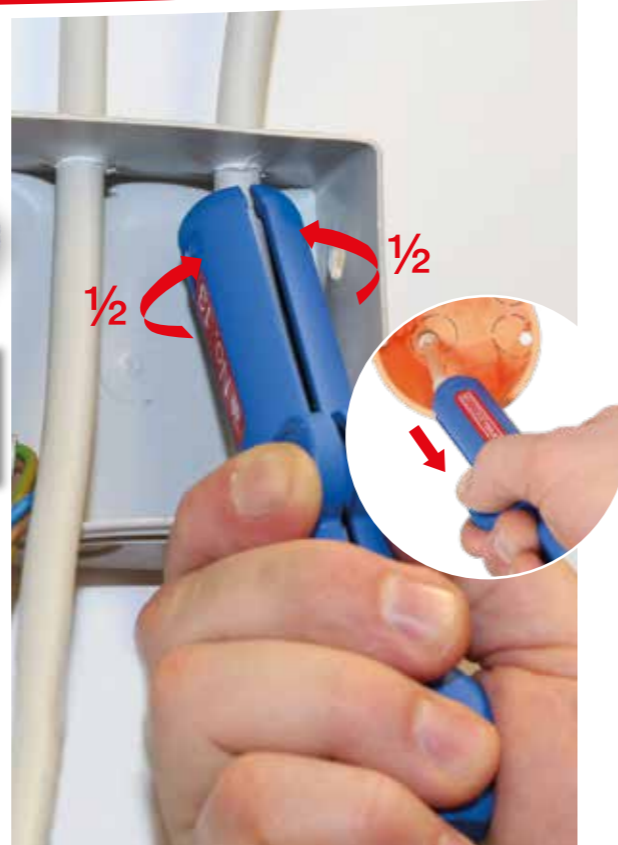

1/2

Quadro-Stripper No. 16

Multifunctional with optimised cable routing

- ▶ circular and longitudinal cutting - stripping - cutting
- ▶ exchangeable hook blade, firmly locked in any position
- ▶ anti-slip handle shape

| mm | g | mm ² | Ømm | Art.-No. |
|-----|----|--------------------------|--------|----------|
| 125 | 53 | 0,5 - 6 (20 - 10 AWG) | 8 - 13 | 52000016 |

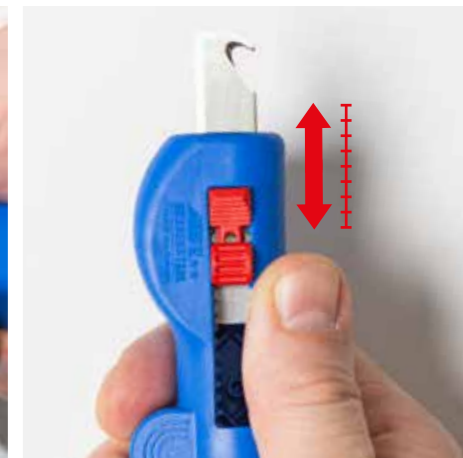

”

No. 16, 13 and 10 are particularly easy to handle thanks to their design. The ergonomic design ensures a safe gripping of the tool, so you won't slip off.

This makes daily work easier and also increases work safety.

Stephan Krampe
Managing Director
Krampe GmbH & Co.KG



Stripping Tools

Our stripping tools enable the safe and convenient stripping of a range of different cable types.

The flexible tools can even be used in areas difficult to access and always provide precise results.

Coax-Stripper No. 1 F Plus

Quick dismantling and stripping of coaxial cables with only one working step

- ▶ space-saving assembly and disassembly of F-connectors due to integrated open hexagon wrench with 11 mm width across flats
- ▶ gripping jaws for screwing F-connectors onto the cable
- ▶ changeable module inserts via click system



DBGM 20 2017 107 094



| mm | g | | Ømm | Art.-No. |
|-----|----|-----------------------------|-----------|----------|
| 125 | 47 | for compression connectors | 6,0 - 8,0 | 52001001 |
| 125 | 47 | for F-screw connectors | 6,0 - 8,0 | 52000001 |
| 125 | 47 | for compression connectors* | 4,0 - 5,0 | 52002001 |

*for mini coaxial cables

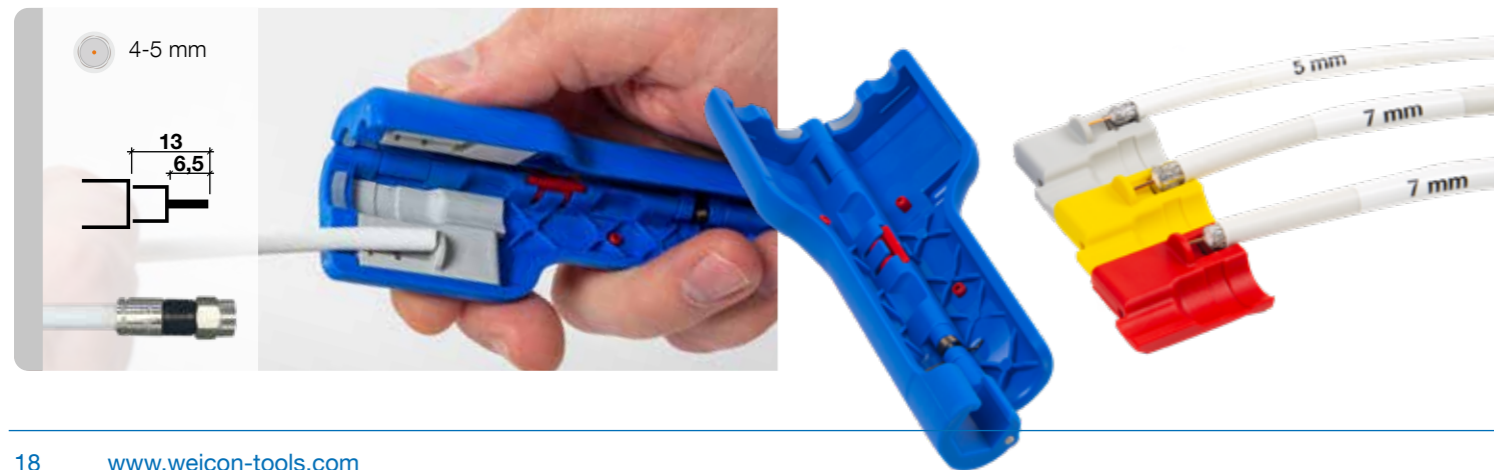

VIDEO



MODIFIED DESIGN

Coax-Stripper No. 2

Good handling due to ergonomic design

- ▶ two-level stripping of all common coaxial cables
- ▶ there is no need to adjust the cutting depth
- ▶ also suitable for flexible cables
- ▶ length scale (0 - 17 mm) integrated in the housing



| mm | g | mm ² | Ømm | Art.-No. |
|-----|----|-----------------|-----------|----------|
| 110 | 28 | - | 4,8 - 7,5 | 52000002 |

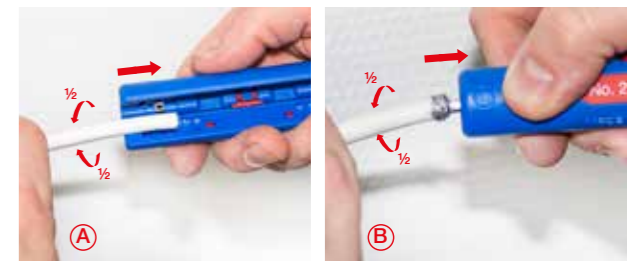
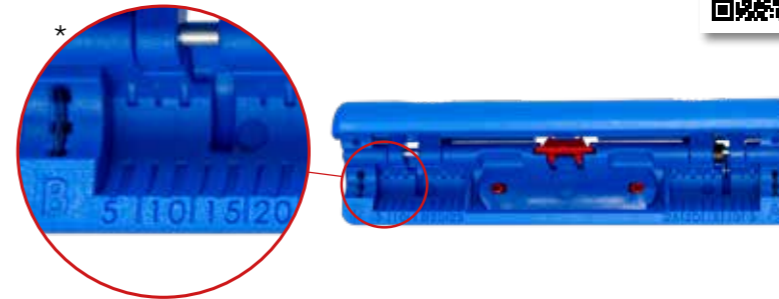

Combi-Coax No. 3

Parallel blade arrangement allows even faster stripping

- ▶ allows two- or three-level stripping of all common coaxial cables
- ▶ also suitable for flexible cables
- ▶ integrated and well accessible side cutter up to 8 mm Ø

| mm | g | mm ² | Ømm | Art.-No. |
|-----|----|-----------------|-----------|----------|
| 125 | 55 | - | 4,8 - 7,5 | 52000003 |



Stripping Tools

Our stripping tools enable the safe and convenient stripping of a range of different cable types.

The flexible tools can even be used in areas difficult to access and always provide precise results.

Cat Cable-Stripper No. 10

Easy and space-saving stripping of data and network cables

- ▶ suitable for e.g. Cat5, Cat6, Cat7 twisted-pair cables (4,5 - 10 mm Ø)
- ▶ integrated length stop, adjustable to the required length
- ▶ safe work with the ergonomic anti-slip handle shape

| mm | g | mm ² | Ømm | Art.-No. |
|-----|----|-----------------|----------|----------|
| 140 | 48 | - | 4,5 - 10 | 52000010 |

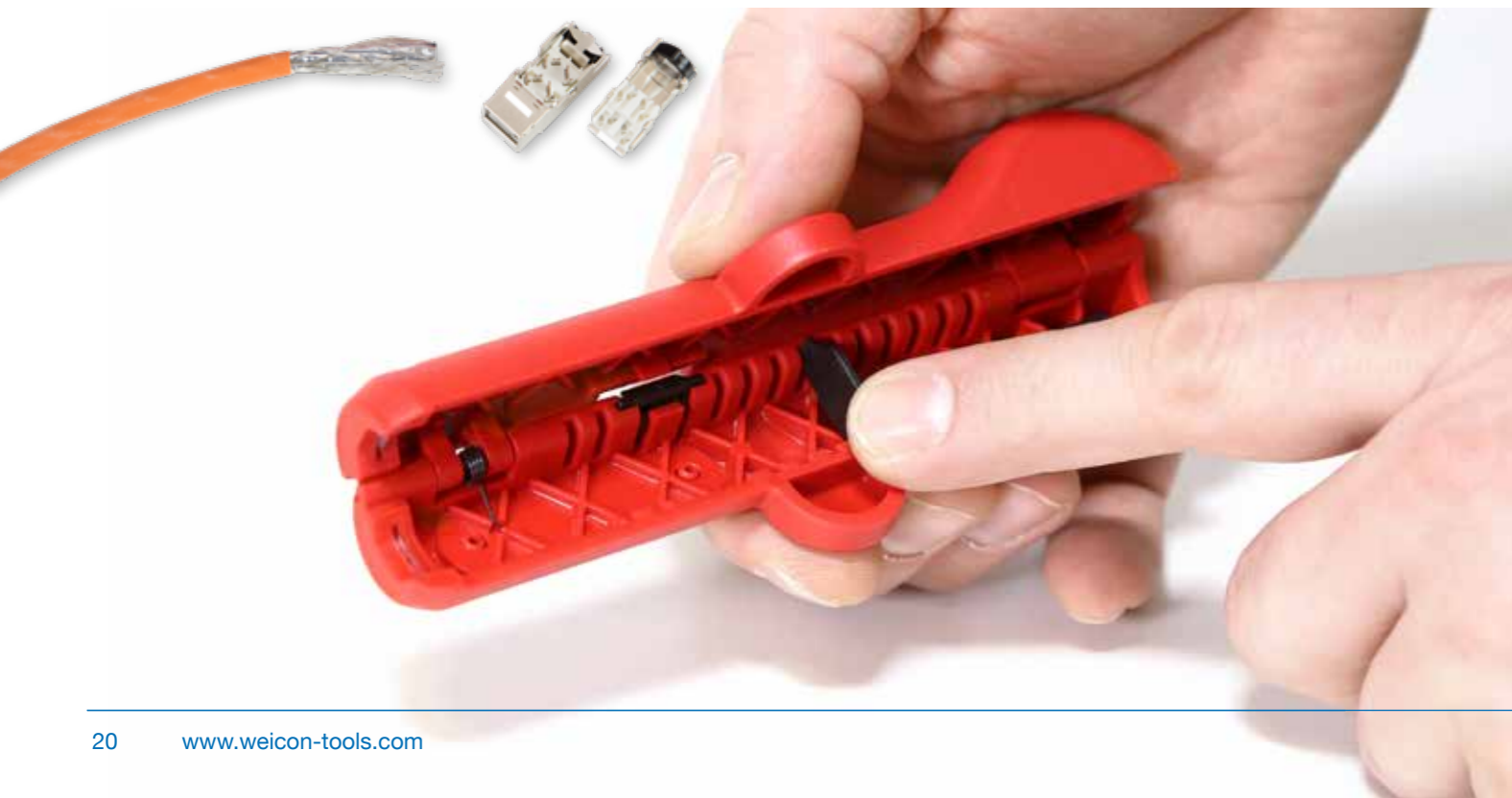
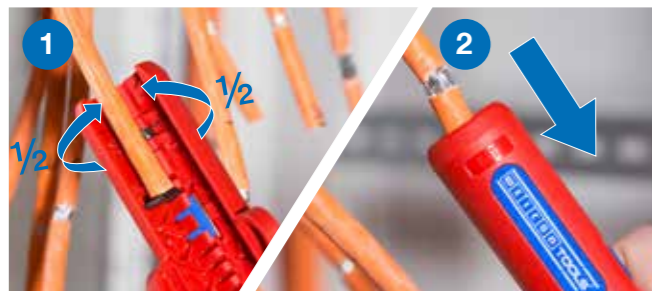

Stripper No. 2 Cat

Easy handling thanks to ergonomic shape

- ▶ for insulated PVC data cables (e.g. Cat5, Cat6, Cat7, twisted-pair cables) with a diameter of 4,5 - 10 mm
- ▶ adjusting the cutting depth manually is not necessary
- ▶ the precise adjustment of the blade removes the outer jacket accurately; with the second blade, the foil shield is slit open carefully and can then be easily removed

| mm | mm ² | Ømm | Art.-No. | |
|-----|-----------------|-----|----------|----------|
| 110 | 28 | - | 4,5 - 10 | 52002002 |

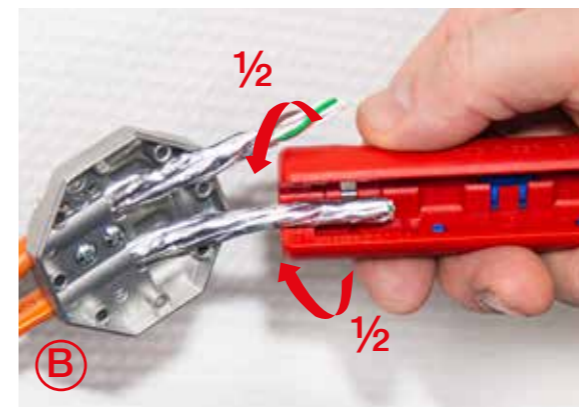
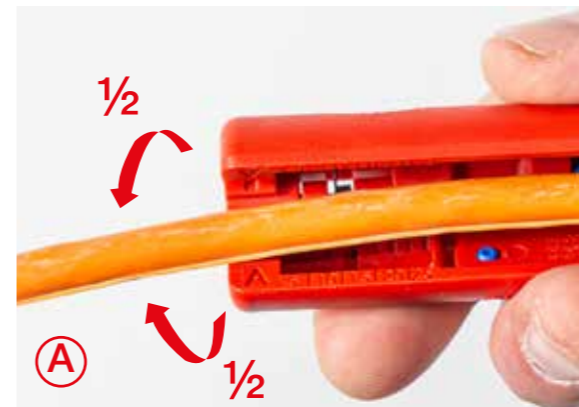

Multi-Purpose Strippers

WEICON TOOLS multi-purpose strippers provide various functions: circular and longitudinal stripping, dismantling and cutting.

This allows professional dismantling and stripping with just one tool.

Mini-Duo No. 150

Automatic wire stripper

- ▶ allows quick and accurate stripping
- ▶ precise work with integrated length scale
- ▶ easily accessible built-in side cutter for cables up to 6 mm²

| mm | g | mm ² | Ømm | Art.-No. |
|-----|-----|--------------------------|-----|----------|
| 160 | 112 | 0,5 - 6 (20 - 10 AWG) | - | 51000150 |

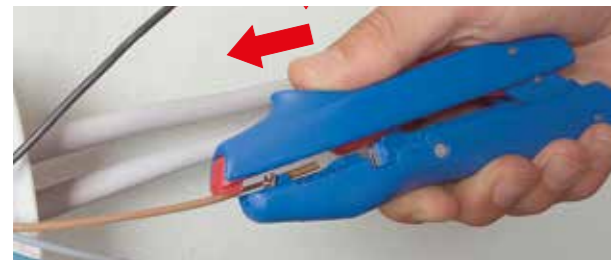

Duo-Crimp No. 300

Stripping and crimping with just one tool

- ▶ insulation removal from 0,5 mm² to 6,0 mm²
- ▶ two crimping ranges are offered (0,5 - 2,5 mm² and 4,0 - 6,0 mm²) according to DIN 46228-2
- ▶ integrated, well accessible side cutter up to 6 mm²

| mm | g | mm ² | Ømm | Art.-No. |
|-----|-----|--------------------------|-----|----------|
| 160 | 116 | 0,5 - 6 (20 - 10 AWG) | - | 51000300 |



VIDEO



Duo-Stripper No. 200

Professional dismantling and stripping

- ▶ quick and simple stripping from 0,5 mm² to 6,0 mm²
- ▶ dismantling: working range 4 - 28 mm Ø
- ▶ spare blade in the handle case

| mm | g | mm ² | Ømm | Art.-No. |
|-----|-----|--------------------------|--------|----------|
| 160 | 123 | 0,5 - 6 (20 - 10 AWG) | 4 - 28 | 51000200 |



STRIPPING + CRIMPING



Multi-Purpose Strippers

WEICON TOOLS multi-purpose strippers provide various functions: circular and longitudinal stripping, dismantling and cutting.

This allows professional dismantling and stripping with just one tool.

Multi-Stripper No. 400

Multifunctional with 4 functions

- ▶ circular cutting - longitudinal cutting - stripping - cutting
- ▶ flush stripping, even in hard-to-reach areas
- ▶ safe and space-saving storage with closing clip

| mm | g | mm ² | Ømm | Art.-No. |
|-----|----|--------------------------|--------|----------|
| 155 | 79 | 0,5 - 6 (20 - 10 AWG) | 8 - 13 | 51000400 |

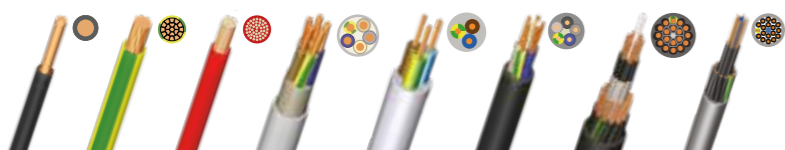

Data-Strip No. 30



Inner blade can be set to the insulation thickness

- ▶ removal of the outer insulation on data cables
- ▶ stripping of conductors and stranded wires, e.g. telephone lines
- ▶ precise stripping with adjustable length stop (3,5 - 14 mm)
- ▶ integrated, well accessible side cutter up to 8 mm Ø

| mm | g | mm ² | Ømm | Art.-No. |
|-----|----|----------------------------------------------|--------|----------|
| 125 | 60 | 0,05 - 0,5 (0,2 - 0,8 Ø) (30 - 20 AWG) | 4 - 10 | 52000030 |



Ø 4 - 10 mm

1

3,5 - 14 mm

2

Ø 0,2 - 0,8 mm

3

Stripper No. 100



Universal tool for dismantling and stripping

- ▶ for many different cable types in building installation
- ▶ flush stripping on ceilings and walls
- ▶ allows circular and longitudinal stripping

| mm | g | mm ² | Ømm | Art.-No. |
|-----|----|--------------------------|--------|----------|
| 140 | 74 | 0,5 - 16 (20 - 6 AWG) | 4 - 13 | 51000100 |

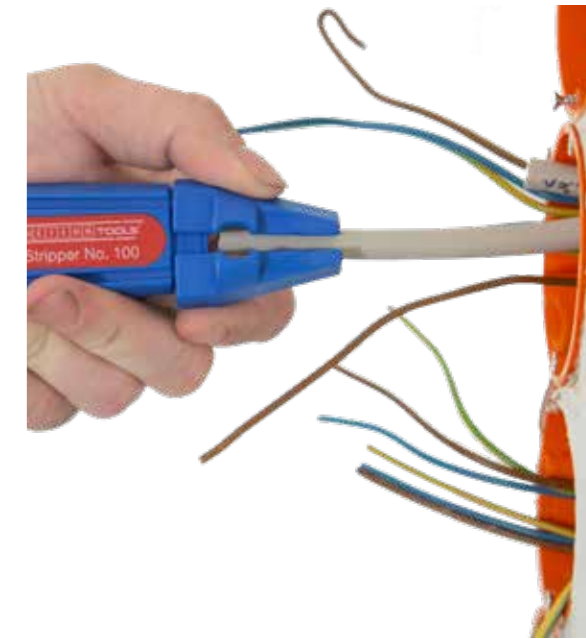
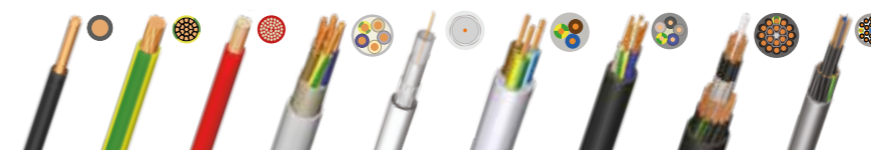

Tool Sets

With our tool sets, we can offer solutions for almost all industries and many different applications.

Starter-Set Pro

Ideal selection for home wiring

- ▶ Wire Stripper No. 5
- ▶ Coax-Stripper No. 2
- ▶ Cable Stripper No. S 4-28
- ▶ Round Cable Stripper No. 13

**TOP
SELECTION**

| mm Length x Width x Height | g | Art.-No. |
|-------------------------------|-----|----------|
| 255 x 210 x 60 | 575 | 52880001 |

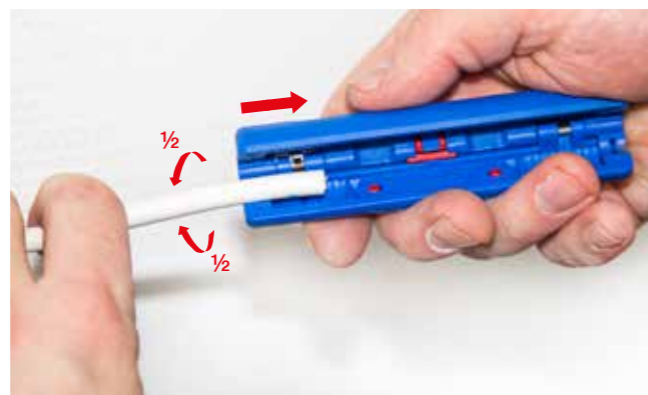

Crimp-Set Pro

All-round equipment for crimping with wire ends

- ▶ Duo-Crimp No. 300
- ▶ Wire Stripper No. 7 Magic
- ▶ high-quality shaker with 400 wire ends (0,5 - 2,5 mm²) according to DIN 46228

| mm Length x Width x Height | g | Art.-No. |
|-------------------------------|-----|----------|
| 340 x 280 x 55 | 950 | 52880002 |



Shaker with wire ends

(DIN 46228)

| Cross Section | Content | Colour |
|----------------------|---------|--------|
| 0,50 mm ² | 50 | white |
| 0,75 mm ² | 100 | grey |
| 1,00 mm ² | 100 | red |
| 1,50 mm ² | 100 | black |
| 2,50 mm ² | 50 | blue |

Electrical Installation Sets

Industrial solutions for skilled trades:
Electrical | Heating/Plumbing | Customer Care | Automotive |
Refrigeration/Air Conditioning | Radio and Television | Home and
Hobby

Electrical Installation Set 1

- ▶ Duo-Crimp No. 300
- ▶ Round Cable Stripper No. 13
- ▶ professional crimping of wire ends
- ▶ two crimping ranges of 0,5 - 2,5 mm² and 4,0 - 6,0 mm²
- ▶ meets the requirements of DIN 46228-21: 1992-02 concerning the pull-off forces
- ▶ side cutter for single wires up to 6 mm²
- ▶ stripping of 0,5 - 6,0 mm²
- ▶ dismantling of all common round cables 6 - 13 mm
- ▶ flush dismantling e.g. at junction and distribution boxes

Art.-No.

52881001



Electrical Installation Set 3

- ▶ Wire Stripper No. 5
- ▶ Coax-Stripper No. 2
- ▶ automatic wire stripper for 0,2 - 6,0 mm²
- ▶ side cutter for single wires up to 2 mm ø
- ▶ adjustable length stop for defined distances at e.g. connection terminals
- ▶ two-level stripping of all common coaxial cables
- ▶ ideal for the installation of SAT systems with multi switches
- ▶ length scale integrated in the housing, e.g. for F-connectors
- ▶ adjustment of cutting depth not necessary

Art.-No.

52881003



Electrical Installation Set 2

- ▶ Wire Stripper No. 5
- ▶ Cable Stripper No. S 4-28
- ▶ automatic wire stripper for 0,2 - 6,0 mm²
- ▶ side cutter for single wires up to 2 mm ø
- ▶ adjustable length stop for defined distances at e.g. WAGO-Clamps
- ▶ cable stripper with working range of 4 - 28 mm
- ▶ adjustable cutting blade for round and longitudinal cutting
- ▶ ideal for the construction of switchboards

Art.-No.

52881002



Electrical Installation Set 4

- ▶ Wire Stripper No. 5
- ▶ Round Cable Stripper No. 13
- ▶ automatic wire stripper for 0,2 - 6,0 mm²
- ▶ side cutter for single wires up to 2 mm ø
- ▶ adjustable length stop for e.g. special distances
- ▶ dismantling of all common round cables from 6 - 13 mm
- ▶ flush dismantling, e.g. at junction and distribution boxes

Art.-No.

52881004



Special Tools

For a series of unusual applications, we provide you with special tools which meet these requirements. Whether it is the dismantling of large cable diameters, tools for the solar industry or working on high voltage cables, WEICON TOOLS has the solution!

Especially for the solar sector

Mini Solar No. 3

Special tools for dismantling and stripping of all common cables in the solar sector

- ▶ quick stripping of all common solar cables with outer diameters from 1,5 mm² to 6 mm²
- ▶ precise work with adjustable length stop (6 - 28 mm)
- ▶ integrated, well accessible side cutter up to 4 mm²

| mm | g | mm ² | Ømm | Art.-No. |
|-----|----|-------------------------|-----|----------|
| 125 | 58 | 1,5 - 6 (15 - 9 AWG) | - | 52002003 |



Wire Stripper No. 7 Solar

Special tools for dismantling and stripping of all common cables in the solar sector

- ▶ automatic wire stripper
- ▶ precise work with optical length scale (up to 26 mm)
- ▶ integrated, well accessible side cutter up to 3 mm Ø

| mm | g | mm ² | Art.-No. |
|-----|-----|----------------------------------------|----------|
| 170 | 218 | Solar cable 1,5 - 6 (15 - 9 AWG) | 51002007 |



LSA Sensor No. 40

For the solderless, screwless and no-stripping inserting and simultaneously cutting of wire ends into LSA punch-down blocks

- ▶ with built-in retractable hook and unlocking blade
- ▶ for conductor diameters 0,35 - 0,9 mm and wire diameters 0,7 - 2,6 mm
- ▶ has a sensor for tracing the wire end position

| mm | g | Ømm | Art.-No. |
|-----|----|------------|----------|
| 185 | 60 | 0,35 - 0,9 | 52000040 |



Cable Scissors No. 35

Cutting - stripping - crimping

- ▶ 2-component handles for increased safety
- ▶ high cutting performance
- ▶ blades made of special stainless steel

| mm | g | Cu/Al | Cu/Al | Art.-No. |
|-----|----|---------------------|---------------------|----------|
| 150 | 90 | <35 mm ² | <50 mm ² | 52000035 |



Special Tools

For a series of unusual applications, we provide you with special tools which meet these requirements. Whether it is the dismantling of large cable diameters, tools for the solar industry or working on high voltage cables, WEICON TOOLS has the solution!



Cable Stripper
H.D. No. 1000

Working with voltage up to 1000 Volt*
Unit testing according to DIN EN 60900

1000 V
IEC: 60900

- ▶ quick cutting of cables with multiple insulations
- ▶ conductor protection with the curved blade tip
- ▶ good transfer of force due to optimised handle shape

| mm | g | Art.-No. |
|-----|----|----------|
| 215 | 93 | 51001000 |

*Tools with safety insulation are basic prerequisites for working on live wires and parts.
Please always pay attention to the legal regulations and follow the corresponding safety advice!



Cable Stripper No. 4 - 29 Spiral **NEW**

round, longitudinal and circular cutting for soft and rigid cable insulations

- ▶ for all common round cables from 4,5 - 29 mm Ø
- ▶ cutting depth can be set comfortably from 0 - 3 mm with lockable control knob in 0,1 mm steps

| mm | g | Ømm | Art.-No. |
|-----|-----|----------|----------|
| 140 | 136 | 4,5 - 29 | 52000029 |



Dismantling Tool
No. 25

For convenient longitudinal and circular cuts

- ▶ safe working thanks to concealed blade
- ▶ wire protection thanks to rounded blade tip
- ▶ easy working even in low temperatures
- ▶ precise, durable, replaceable turning blade

| mm | g | mm | mm | Art.-No. |
|-----|-----|--------|------------|----------|
| 210 | 163 | >25 mm | 0 - 5,0 mm | 52000025 |



Multi-Opener



The ideal tool for the gentle opening of sensitive equipment and dismantling of clipped housings

- ▶ no scratching of sensitive surfaces
- ▶ dissipative ESD material protects against electrostatic discharge
- ▶ flexible fibreglass-reinforced polyamide
- ▶ stainless steel blade to remove adhesive residues

| mm | g | Surface Resistance | Art.-No. |
|-----|----|---------------------------|----------|
| 180 | 22 | approx. 10 ⁹ Ω | 52800000 |

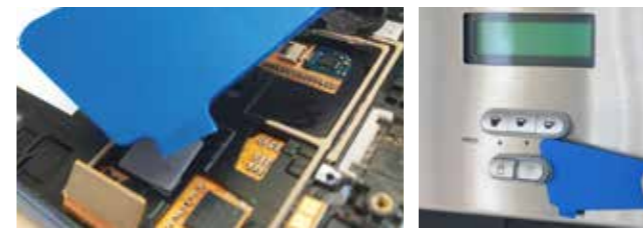

Easy Opener®



Special tool for the gentle disassembly of sensitive components without damaging the material

- ▶ ideal for loosening switches, luminaires or similar components
- ▶ flexible and stable at the same time
- ▶ three surfaces with different material thickness

| mm | g | Art.-No. |
|-----|----|----------|
| 180 | 22 | 52800001 |



Our
DIY TIP!



Spare Parts & Selling Aids

Spare Parts for Tools

| Art. No. | Name | PU | |
|----------|----------------------------------------------------------------|----|--|
| 50100002 | Spare blade for Cable Stripper series S 4 - 28 Inner blade | 1 | |
| 50100001 | Spare blade for Cable Strippers Inner blade | 1 | |
| 51100008 | Spare blade for No. 200 Inner blade | 1 | |
| 51100002 | Spare blade set No. 5/No. 6 2 blades + 1 screw | 1 | |
| 51100006 | Spare blade set No. 7 Magic 2 blades + 4 screws | 1 | |
| 51100007 | Spare blade set No. 7-F 2 blades + 4 screws | 1 | |
| 51100005 | Spare blade set No. 7 Solar | 1 | |
| 52953030 | Spare blade set No. 30 Data-Strip 1 blade + adjusting screw | 1 | |
| 51953020 | Spare blade set for No. 150 / No. 200 / No. 300 | 1 | |
| 52953020 | Spare blade for Dismantling Tool No. 25 Double edge blade | 1 | |
| 52953050 | Spare blade for Cable Stripper 4-29 Spiral | 1 | |
| 52953040 | Hook knife for No. 16 1 hook knife 1 slider + 1 screw | 1 | |
| 52100008 | Inserts for No.1 F Plus 6/4 | 6 | |
| 52100009 | Inserts for No.1 F Plus 6.5/6.5 | 6 | |
| 52100010 | Inserts for No.1 F Plus 6/4 *for mini coaxial cables | 6 | |



Display Cable Stripper
50951050



WEICON TOOLS Display
50952000
WEICON TOOLS Display
with LED lighting
50952000-LICHT



Roll-Up
99951078

Stickers



Poster



Foam Display
without tools
50951199
Example: 12x Dismantler



Foam Display
without tools
50951198
Example: 6x Wire Stripper

WEICON TOOLS® Cable Overview

The cable types shown in the table below are only meant to give an overview of the potential application areas of our tools. WEICON TOOLS can also be used on similar cable types in many cases, of course. Furthermore, the application suggestions depend on the material, application area and working range. Our tool recommendation is only a suggestion due to the various materials used by cable manufacturers.

| Cable | Name | Example | Suggested application Dismantling | Suggested Application Stripping |
|-------|-----------------------------------------------------------------|--------------|------------------------------------------------------------------------------|-----------------------------------------------------------------------------------------------------------------------------------|
| | PVC - coated conductor | (N)YM | All Cable Strippers, No. 13, No. 16, No. 100, No. 200, No. 400, No. 7 Magic | No. S 4 - 28 Multi, No. 5, No. 6, No. 7 Magic, No. 7-F, No. 16, No. 100, No. 200, No. 400 |
| | PVC - sheathed cable for low mechanical loads | H05VV-F | All Cable Strippers (working range from 4 mm), No. 3, No. 200, No. 7 Magic | No. 2, No. 3, No. S 4 - 28 Multi, No. 5, No. 6, No. 7 Magic, No. 7-F, No. 16, No. 100, No. 200, No. 400, |
| | Rubber tube conductor for light mechanical loads | H05RR-F | All Cable Strippers, No. 7 Magic, No. 13, No. 16, No. 100, No. 200, No. 400 | No. S 4 - 28 Multi, No. 5, No. 6, No. 7 Magic, No. 7-F, No. 16, No. 100, No. 200, No. 400 |
| | Rubber - control line | (N)FLGöu | All Cable Strippers, No. 7 Magic, No. 13, No. 16, No. 100, No. 200, No. 400, | No. S 4 - 28 Multi, No. 5, No. 6, No. 7 Magic, No. 7-F, No. 16, No. 100, No. 200, No. 400 |
| | PVC - construction cables | XYMM K3 | All Cable Strippers, No. 7 Magic, No. 13, No. 16, No. 100, No. 200, No. 400 | No. S 4 - 28 Multi, No. 5, No. 6, No. 7 Magic, No. 7-F, No. 16, No. 100, No. 200, No. 400 |
| | PVC - control line | | All Cable Strippers, No. 7 Magic, No. 13, No. 16, No. 100, No. 200, No. 400, | No. S 4 - 28 Multi, No. 5, No. 6, No. 7 Magic, No. 7-F, No. 16, No. 100, No. 200, No. 400 |
| | PVC - control line oil resistant | 73H05VV5-F | All Cable Strippers, No. 7 Magic, No. 13, No. 16, No. 100, No. 200, No. 400, | No. S 4 - 28 Multi, No. 5, No. 6, No. 7 Magic, No. 7-F, No. 16, No. 100, No. 200, No. 400 |
| | PVC - motor connection cables | SLM 0,6/1 kV | All Cable Strippers, No. 7 Magic, No. 13, No. 16, No. 100, No. 200, No. 400, | No. S 4 - 28 Multi, No. 5, No. 6, No. 7 Magic, No. 7-F, No. 16, No. 100, No. 200, No. 400 |
| | PVC - sheathed cable for medium mechanical loads | H05VV-F | All Cable Strippers, No. 7 Magic, No. 13, No. 16, No. 100, No. 200, No. 400, | No. S 4 - 28 Multi, No. 5, No. 6, No. 7 Magic, No. 7-F, No. 16, No. 100, No. 200, No. 400 |
| | PVC insulated high voltage cables, single and multi-core cables | E-YY | No. 25, No. 1000 | --- |
| | PVC insulated cables with aluminium conductor | E-AYY | No. 25, No. 1000 | --- |
| | PVC insulated telecommunications sheathed wires 0,6 mm | YYSch | No. 7 Magic | No. 5, No. 6, No. 7 Magic, No. 7-F, Precision Wire Stripper S/ESD |
| | PVC insulated telecommunications sheathed wires 0,8 mm | YR | No. 7 Magic | No. 5, No. 6, No. 7 Magic, No. 7-F, Precision Wire Stripper S/ESD |
| | PVC - single wire core conductor | H05V-U | --- | No. S 4 - 28 Multi, No. 5, No. 6, No. 7 Magic, No. 7-F, No. 16, No. 100, No. 200, No. 400 |
| | PVC - multiple wire core conductor | H07V-R | --- | No. S 4 - 28 Multi, No. 5, No. 6, No. 7 Magic, No. 7-F, No. 100 |
| | PVC - fine wire core conductor | H05V-K | --- | No. S 4 - 28 Multi, No. 5, No. 6, No. 7 Magic, No. 7-F, No. 16, No. 100, No. 200, No. 300, No. 400, Precision Wire Stripper S/ESD |
| | PVC - wiring conductor fine wire | H07V-K | --- | No. S 4 - 28 Multi, No. 5, No. 6, No. 7 Magic, No. 7-F, No. 16, No. 100, No. 200, No. 300, No. 400, Precision Wire Stripper S/ESD |

| Cable | Name | Example | Suggested application Dismantling | Suggested Application Stripping |
|-------|------------------------------------------------------------------------------|--------------|-----------------------------------|---------------------------------------|
| | PVC ignition cable e.g. in the vehicle industry | AYZL | --- | No. 2, No. 3 |
| | Coaxial cables for the transmission of high frequency signals and conductors | RG 59 B/U | No. 1, No. 2, No. 3, No. 100 | No. 1, No. 2, No. 3, No. 100 |
| | Coaxial cables (SAT compatible) | 2YALGY | No. 1, No. 2, No. 3, No. 100 | No. 1, No. 2, No. 3, No. 100 |
| | Special PVC loud speaker cable | 26 LFZ-XY | --- | No. 7 Magic, No. 7-F |
| | PVC twin conductor | (H)03VH-H | --- | No. 7 Magic, No. 7-F |
| | PVC flat twin and earth cable | | No. 7-F | No. 7-F |
| | Flat rubber cables for medium mechanical loads | | No. 7-F | No. 7-F |
| | Solar cables | H1Z2Z2-K | Mini-Solar No. 3, No. 7 Solar | Mini-Solar No. 3, No. 7 Solar |
| | Installation cables for fire alarm systems | JB-Y(ST)Y | No. 2 Cat, No. 10, No. 30 | No. 30 |
| | Installation cables for telecommunications systems | F-vYAY | No. 2 Cat, No. 10, No. 30 | No. 30, Precision Wire Stripper S/ESD |
| | Electronic - control lines | LiYY | No. 2 Cat, No. 10, No. 30 | No. 30, Precision Wire Stripper S/ESD |
| | Installation cables for industry electronics | JE-Y(ST)Y Bd | No. 2 Cat, No. 10, No. 30 | No. 30, Precision Wire Stripper S/ESD |
| | BUS cable | | No. 2 Cat, No. 10, No. 30 | No. 30 |
| | Patch cable with film shield for local networks | LAN 200flex | No. 2 Cat, No. 10, No. 30 | No. 30 |
| | Data cable (Cat 7) | LAN 1000 | No. 2 Cat, No. 10, No. 30 | No. 30 |
| | Rubber core conductor with higher heat resistance | A07RN-R | --- | No. 2, No. 3 |
| | Silicone core conductor | SiF | --- | No. 2, No. 3 |
| | Fibre optic | | --- | Fibre Optic Stripper |

WEICON TOOLS® Application Examples

PHOTOVOLTAIC/SOLAR

Wire Stripper No. 7 Solar
Automatic stripping of solar cables



Mini-Solar No. 3
Stripping of solar cables



KITCHEN/LIVING ROOM

Round Cable Stripper No. 13
Stripping on cavity wall boxes



Wire Stripper No. 5
Stripping of all common stranded and solid wires



DIY/WORKSHOP

Duo-Crimp No. 300
Crimping wire end ferrules



Multi-Stripper No. 400
Wire stripping and dismantling



Precision Wire Stripper S
For thin wires and conductors



LIVING ROOM

Coax-Stripper No. 1 F Plus
Stripping coaxial cables



LSA Sensor No. 40
Installation network socket



Stripper No. 2 Cat
Stripping data cables (e.g. CAT 7)



UTILITY ROOM

Cable Stripper S 4-28
Removing the outer sheath, e.g. NYM



Wire Stripper No. 6
Stripping of all common stranded and solid wires



Fibre Optic Stripper
Removing the coating of fibre optic cables



HEATING/AIR CONDITIONING

Wire Stripper No. 7 Magic
Wire stripping and dismantling



Quadro-Stripper No. 16
Wire stripping and dismantling



WEICON TOOLS® Certificates

ZERTIFIKAT

für eine Fertigungsstätte von Erzeugnissen, die mit einem TÜV NORD CERT Sicherheitszeichen versehen werden

Weicon GmbH & Co. KG
Königsberger Straße 255
48157 Münster
Deutschland

Fertigungsstätte: Weicon GmbH & Co. KG
Königsberger Straße 255
48157 Münster
Deutschland

Erzeugnisse: Absoluterwerkzeuge

Tag des Besuchs: 05.06.2020

Ergebnis der Besichtigung:
Der Antragsteller konnte nachweisen, dass die Fertigungsstätte der aufgeführten Erzeugnisse technisch so eingerichtet und geleitet ist, dass eine gleichmäßige Herstellung gewährleistet ist.

Registrier-Nr. 44 786 131137-001
Prüfbericht-Nr. 3526 3763
Aktuelle-Nr. 2-4-853/02

Gültigkeit
von 2020-06-02
bis 2021-06-01

TÜV NORD CERT GmbH
Zertifizierungsstelle Konsumgüter
TÜV NORD CERT GmbH Langenmarkstraße 20 45141 Essen www.tuv-nord-cert.de product@tuv-nord.de



Management System
ISO 9001:2015
ISO 14001:2015

www.tuv.com
ID 9108636595

Further certificates
on request!

PRIVATE LABEL TOOLS

We also provide the opportunity to design the tools in a variety of colour combinations and individually with your company print/logo.

We would be pleased to submit a detailed offer.



individual colour combinations



WEICON TOOLS® Product Overview

CABLE STRIPPERS



Cable Stripper No. S 4 - 28
Art.-No. 50055328



Cable Stripper No. S 4 - 28 Multi
Art.-No. 50057328

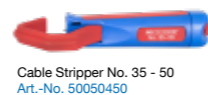

Cable Stripper No. 35 - 50
Art.-No. 50050450



Cable Stripper No. 28 - 35
Art.-No. 50050435



Cable Stripper No. 4 - 28 G
Art.-No. 50054428



Cable Stripper No. 4 - 28 H
Art.-No. 50054328



Cable Stripper No. 4 - 16
Art.-No. 50050116



Cable Stripper No. 8 - 27
Art.-No. 50050227



Cable Stripper No. C 4 - 16
Art.-No. 50053116



Cable Stripper No. C 8 - 27
Art.-No. 50053227



Cable Stripper No. C 4 - 28
Art.-No. 50053328

WIRE STRIPPERS



Wire Stripper No. 5
Art.-No. 51000005



Wire Stripper No. 5 Classic
Art.-No. 51003005



Wire Stripper No. 6
Art.-No. 51000006



ESD Precision Wire Stripper
Art.-No. 51001002



Wire Stripper No. 7 Magic
Art.-No. 51000007



Wire Stripper No. 7-F
Art.-No. 51001007



Precision Wire Stripper S
Art.-No. 51000002



Fibre Optic Stripper
Art.-No. 51002002

STRIPPING TOOLS

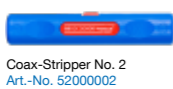

Coax-Stripper No. 2
Art.-No. 52000002



Stripper No. 2 Cat
Art.-No. 52002002



Cat Cable-Stripper No. 10
Art.-No. 52000010

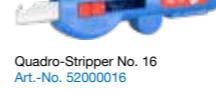

Quadro-Stripper No. 16
Art.-No. 52000016



Combi-Coax No. 3
Art.-No. 52000003



Round Cable Stripper No. 13
Art.-No. 52000013



Round Cable Stripper No. 13 Classic
Art.-No. 52003013



No. 1 F Plus for screw connectors
Art.-No. 52000001



No. 1 F Plus F-compression connectors
Art.-No. 52001001



No. 1 F Plus F-compression connectors
for mini coaxial cables
Art.-No. 52002001

| | |
|------------------------------------|-------|
| Cable Scissors No. 35..... | p. 31 |
| Cable Stripper H. D. No. 1000..... | p. 32 |
| Cable Stripper No. 28 - 35..... | p. 9 |
| Cable Stripper No. 35 - 50..... | p. 9 |
| Cable Stripper No. 4 - 16..... | p. 9 |
| Cable Stripper No. 4 - 28 G..... | p. 9 |
| Cable Stripper No. 4 - 28 H..... | p. 9 |
| Cable Stripper No. 8 - 27..... | p. 9 |

| | |
|-----------------------------------------|-------|
| Cable Stripper No. C 4 - 16..... | p. 9 |
| Cable Stripper No. C 4 - 28..... | p. 9 |
| Cable Stripper No. C 8 - 27..... | p. 9 |
| Cable Stripper No. S 4 - 28..... | p. 7 |
| Cable Stripper No. S 4 - 28 Multi..... | p. 7 |
| Cable Stripper No. S 4 - 29 Spiral..... | p. 32 |
| Cat Cable-Stripper No. 10..... | p. 22 |
| Coax-Stripper No. 1 F Plus..... | p. 18 |

| | |
|------------------------------|-------|
| Coax-Stripper No. 2..... | p. 19 |
| Combi-Coax No. 3..... | p. 19 |
| Crimp-Set Pro..... | p. 27 |
| Data-Strip No. 30..... | p. 25 |
| Dismantling Tool No. 25..... | p. 22 |
| Duo-Crimp No. 300..... | p. 32 |
| Duo-Stripper No. 200..... | p. 22 |
| Easy Opener..... | p. 33 |

Note: Work with WEICON TOOLS is only permitted on zero-potential cables and conductors.

MULTI-PURPOSE STRIPPERS



Duo-Crimp No. 300
Art.-No. 51000300



Mini-Duo No. 150
Art.-No. 51000150



Duo-Stripper No. 200
Art.-No. 51000200



Multi-Stripper No. 400
Art.-No. 51000400



Stripper No. 100
Art.-No. 51000100



Data-Strip No. 30
Art.-No. 52000030

SETS



Starter-Set Pro
Art.-No. 52880001



Crimping-Set Pro
Art.-No. 52880002



Electrical Installation Set 1
Art.-No. 52881001



Electrical Installation Set 2
Art.-No. 52881002

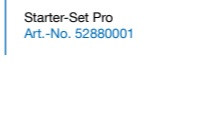

Electrical Installation Set 3
Art.-No. 52881003

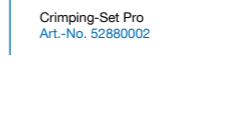

Electrical Installation Set 4
Art.-No. 52881004



Electrical Installation Set 3
Art.-No. 52881003



Electrical Installation Set 4
Art.-No. 52881004

SPECIAL TOOLS



Cable Stripper H. D. No. 1000
Art.-No. 51001000



Dismantling Tool No. 25
Art.-No. 52000025



LSA Sensor No. 40
Art.-No. 52000040

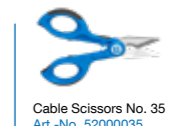

Cable Scissors No. 35
Art.-No. 52000035



Mini-Solar No. 3
Art.-No. 52002003



Wire Stripper No. 7 Solar
Art.-No. 51002007

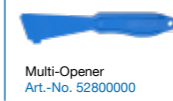

Multi-Opener
Art.-No. 52800000

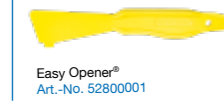

Easy Opener®
Art.-No. 52800001



Cable Stripper No. 4 - 29 Spiral
Art.-No. 52000029

| | |
|-------------------------------------------|-------|
| Electrical Installation Sets 1/2/3/4..... | p. 28 |
| ESD Precision Wire Stripper..... | p. 15 |
| Fibre Optic Stripper..... | p. 15 |
| Mini-Duo No. 150..... | p. 31 |
| Mini-Solar No. 3..... | p. 22 |
| Multi-Opener..... | p. 30 |
| Multi-Stripper No. 400..... | p. 33 |

| | |
|------------------------------------------|-------|
| Precision Wire Stripper S..... | p. 14 |
| Quadro-Stripper No. 16..... | p. 17 |
| Round Cable Stripper No. 13..... | p. 16 |
| Round Cable Stripper No. 13 Classic..... | p. 16 |
| Starter-Set Pro..... | p. 26 |
| Stripper No. 100..... | p. 25 |
| Stripper No. 2 Cat..... | p. 21 |
| Wire Stripper No. 5..... | p. 10 |

| | |
|----------------------------------|-------|
| Wire Stripper No. 5 Classic..... | p. 11 |
| Wire Stripper No. 6..... | p. 11 |
| Wire Stripper No. 7 Magic..... | p. 12 |
| Wire Stripper No. 7 Solar..... | p. 30 |
| Wire Stripper No. 7-F..... | p. 13 |

Note: Work with WEICON TOOLS is only permitted on zero-potential cables and conductors.

WEICON TOOLS®

No. 1 in Form & Funktion



MESSERSTAHL
Qualität aus Solingen



WEICON GmbH & Co. KG
(Headquarters)
Germany
phone +49 (0) 251 9322 0
info@weicon.de

WEICON Middle East L.L.C.
United Arab Emirates
phone +971 4 880 25 05
info@weicon.ae

WEICON Inc.
Canada
phone +1 877 620 8889
info@weicon.ca
www.weicon.ca

WEICON Kimya Sanayi Tic. Ltd. Şti.
Turkey
phone +90 (0) 212 465 33 65
info@weicon.com.tr
www.weicon.com.tr

WEICON Romania SRL
Romania
phone +40 (0) 3 65 730 763
office@weicon.com

WEICON SA (Pty) Ltd
South Africa
phone +27 (0) 21 709 0088
info@weicon.co.za

WEICON South East Asia Pte Ltd
Singapore
phone (+65) 6710 7671
info@weicon.com.sg

WEICON Czech Republic s.r.o.
Czech Republic
phone +42 (0) 417 533 013
info@weicon.cz

WEICON Ibérica S.L.
Spain
phone +34 (0) 914 7997 34
info@weicon.es

WEICON Italia S.r.L.
Italy
phone +39 (0) 329 235 9592
info@weicon.it

www.weicon-tools.com

Art.-No. 50900002

X-ON Electronics

Largest Supplier of Electrical and Electronic Components

Click to view similar products for [Hand Tools](#) category:

Click to view products by [Weicon](#) manufacturer:

Other Similar products are found below :

[58284-1](#) [662908-1](#) [68764-0001](#) [690619-6](#) [7-354778-7](#) [768531-1](#) [810131](#) [81541-16](#) [854183-1](#) [854358-1](#) [90855-1](#) [992258-1](#) [1-21046-3](#) [1-22145-3](#) [1-22278-2](#) [1-24954-2](#) [125529-5](#) [1-305579-8](#) [1320846-1](#) [1338618-1](#) [1338968-2](#) [1-354779-0](#) [1-354779-2](#) [1-354779-4](#) [1424443-1](#) [1424266-1](#) [1424289-1](#) [1424444-1](#) [MS24256A16](#) [1-525441-1](#) [1532195-2](#) [1538773-2](#) [1-692134-3](#) [HT-920A-124-HTELE-RPL-KIT](#) [1976923-1](#) [1976969-1](#) [2063794-1](#) [2063795-1](#) [2-21002-1](#) [2-21002-4](#) [2-21002-7](#) [2-21002-9](#) [2-21004-0](#) [229707-1](#) [911737-2](#) [91348-2](#) [925980-R](#) [301185-9](#) [983533-1](#) [1-694433-7](#)