



WEICON TOOLS®

No.1 in Form & Funktion

Catalogue



STRIPPING TOOLS



reddot winner 2020



Download Now



www.weicon.com/app



www.weicon-tools.com

V 1.21



Management System
ISO 9001:2015
ISO 14001:2015

www.tuv.com
ID 9108636595



**FAMILY BUSINESS
SINCE 1947**

We develop, produce and distribute an extensive range of stripping tools. This includes cable knives, wire strippers, dismantling and multi-functional tools. Our tools have been developed for accurate, fast and safe stripping of all common cable types. They carry the GS seal of TÜV Nord and were developed under the aspects of work safety. The tools are specifically tailored to the needs of professional users, are found in both, crafts and industrial use, and are also suitable for domestic use.

Besides the WEICON TOOLS, WEICON produces special chemo-technical products for the industry. The product range of the company includes special adhesives and sealants, technical sprays as well as high performance assembly pastes and greases for all areas of industry - from the production, repair and maintenance to servicing.

The company headquarters are located in Muenster, Germany. WEICON has subsidiaries in Dubai, Canada, Turkey, Romania, South Africa, Singapore, the Czech Republic, Spain and in Italy and is represented by WEICON partners in more than 120 countries all over the world.



Fast and individual service



Strong sales support



Next day delivery



Member of the Association of German Tool Manufacturers



For more information on all WEICON products, visit www.weicon.com

Content

Content	Page
WEICON TOOLS.....	4
Cable Strippers	6
• S 4 - 28.....	7
• S 4 - 28 Multi.....	7
• C 4 - 16.....	9
• C 8 - 27.....	9
• C 4 - 28.....	9
• No. 4 - 16.....	9
• No. 8 - 27.....	9
• No. 4 - 28 H.....	9
• No. 4 - 28 G.....	9
• No. 28 - 35.....	9
• No. 35 - 50.....	9
Wire Strippers	10
• No. 5.....	10
• No. 5 Classic.....	11
• No. 6.....	11
• No. 7 Magic.....	12
• No. 7 F.....	13
• Precision Wire Stripper S.....	14
• ESD Precision Wire Stripper.....	15
• Fibre Optic Stripper.....	15
Stripping Tools	16
• Round Cable Stripper No. 13.....	16
• Round Cable Stripper No. 13 Classic.....	16
• Quadro-Stripper No. 16.....	17
• Coax-Stripper No. 1 F Plus.....	18
• Coax-Stripper No. 2.....	19
• Combi-Coax No. 3.....	19
• Cat Cable-Stripper No. 10.....	20
• Stripper No. 2 Cat.....	21
Multi-Purpose Strippers	22
• Mini-Duo No. 150.....	22
• Duo-Stripper No. 200.....	22
• Duo-Crimp No. 300.....	23
• Multi-Stripper No. 400.....	24
• Data-Strip No. 30.....	25
• Stripper No. 100.....	25
Tool Sets	26
• Starter-Set Pro.....	26
• Crimp-Set Pro.....	27
• Electrical Installation Sets.....	28
Special Tools	30
• Mini-Solar No. 3.....	30
• Wire Stripper No. 7 Solar.....	30
• Cable Scissors No. 35.....	31
• LSA Sensor No. 40.....	31
• H.D. No. 1000.....	32
• Dismantling Tool No. 25.....	32
• Cable Stripper No. 4 - 29 Spiral.....	32
• Easy Opener®.....	33
• Multi-Opener.....	33
Other	34
• Spare Parts.....	34
• Selling Aids.....	35
• Cable Overview.....	36
• Application Examples.....	38
• Certificates.....	40
• Stripping Tools for Private Label.....	41
• Product Overview.....	42



Scan your way to the video!

You will find QR codes on our product pages that lead directly to our application videos!

With kind support from





Discover our WEICON TOOLS®



We produce **SUSTAINABLY!**



Since the beginning of 2020, we have been packaging our WEICON TOOLS products in recyclable cardboard boxes. These will come in three different sizes in the future to protect all tools produced by our Muenster-based family business.

WEICON TOOLS®



Member of the German Tool Industry Association



We develop, manufacture and distribute high-quality wire stripping and other special tools for the industry and professional users and can look back on almost 50 years of success by now.

We present these tools at more than 40 fairs and trade shows every year, all over the world. We keep in constant contact with our users, who tell us about new developments in their work processes and, that way, give us ideas and requests for new or improved WEICON TOOLS. This exchange of information generates a process that regularly results in product innovations and modifications and therefore enables us to constantly offer our customers the perfectly engineered and up-to-date solutions they need.

Quality and continuity "made in Germany"
INNOVATIVE AND RELIABLE!



reddot winner 2020



In the development of our high-quality stripping tools, we have been working together with the company Krampe from Ascheberg-Herbern near Muenster since 1990.

Our consistent key focus in the production process is on precision to ensure that the products we offer are always of exceptional quality.

Our products are made of high-quality materials, hold numerous certificates and are characterised by their outstanding functionality and durability.



Discover our
WEICON TOOLS®



Cable Strippers S 4 - 28

- ▶ completely ergonomic & fully insulated
- ▶ continuous regulation and easy to operate adjusting wheel
- ▶ precise, quick and safe stripping



EU.Pat.no. 07114242.6

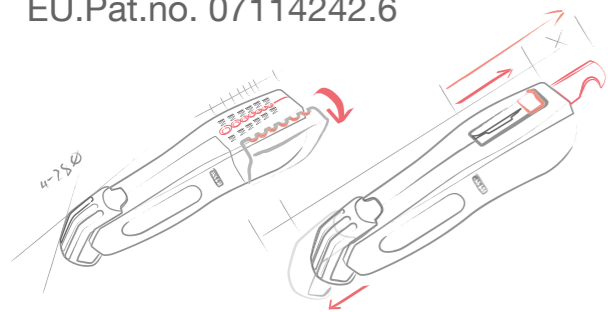

**Working range
4 - 28 mm Ø**

“ Our S4 - 28 range is certainly something special. There are no other comparable tools on the market. The right cable stripper can be found for almost any application area thanks to the different types.

Its extraordinary shape ensures a safe and comfortable grip. Furthermore, the retractable blade of the S 4 - 28 is a milestone in the area of safety at work.

Gerold Specking
Product Manager
WEICON TOOLS

”

No. S 4 - 28 Multi

Stripping function integrated in the housing

- ▶ stripping of all standard flexible and solid cables with a cross-diameter between 0,5 and 6 mm²

mm	g	mm ²	Ømm	Art.-No.
145	61	0,5 - 6 (20 - 10 AWG)	4 - 28	50057328



No. S 4 - 28

Safe due to retractable hook blade

- ▶ the blade can be locked in both positions

mm	g	mm ²	Ømm	Art.-No.
145	72	-	4 - 28	50055328



Cable Strippers 4 - 28

- ▶ completely ergonomic & fully insulated
- ▶ continuous regulation and easy to operate adjusting wheel
- ▶ precise, quick and safe stripping

Discover our
WEICON TOOLS®

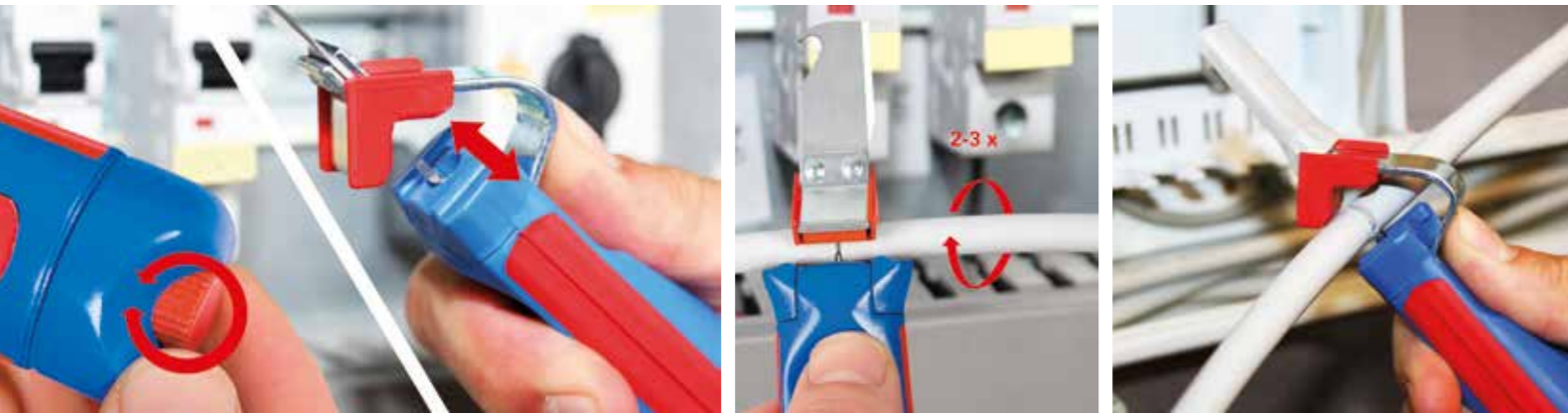

- ① Setting screw
- ② Inner blade
- ③ Bracket with or without blade
- ④ POM part
- ⑤ Cap (on cable stripper with blade)
- ⑥ Outer casing with anti-slip 2-component handle
- ⑦ Closure cap

Cable Strippers

	↔ mm	g	Ømm	Art.-No.
No. 4 - 16	140	84	4 - 16	50050116



No. 8 - 27	140	92	8 - 28	50050227
-------------------	-----	----	--------	----------

	↔ mm	g	Ømm	Art.-No.
No. 4 - 28 H	185	98	4 - 28 with hook blade	50054328



	↔ mm	g	Ømm	Art.-No.
No. 4 - 28 G	195	104	4 - 28 with straight blade	50054428



	↔ mm	g	Ømm	Art.-No.
No. 28 - 35	170	87	28 - 35	50050435



No. 35 - 50	180	90	35 - 50	50050450
--------------------	-----	----	---------	----------



Cable Strippers

	↔ mm	g	Ømm	Art.-No.
No. C 4 - 16	135	67	4 - 16	50053116



No. C 4 - 16

No. C 8 - 27

No. C 8 - 27	135	69	8 - 28	50053227
---------------------	-----	----	--------	----------

No. C 4 - 28	180	80	4 - 28 with hook blade	50053328
---------------------	-----	----	---------------------------	----------



No. C 4 - 28

Wire Strippers

Automatic wire strippers for all common stranded and solid conductors. A scanning system adjusts automatically to the required wire diameter, and thus permits fast and simple dismantling and stripping.

Discover our WEICON TOOLS®



Our Bestseller

No. 5

Space-saving thanks to locking mechanism

- ▶ automatic wire stripper
- ▶ precise work with adjustable length stop (5 - 12 mm)
- ▶ integrated, well accessible side cutter up to 2 mm Ø

mm	g	mm²	Ømm	Art.-No.
170	107	0,2 - 6 (24 - 10 AWG)		51000005

selbst ist der Mann
Das Do-it-yourself-Magazin

PRAXISTEST
Kategorie: Ader-Abisolier-Werkzeuge
SEHR GUT (1,3)
2 Produkte mit SEHR GUT

TESTSIEGER
Ausgabe 04/2018
11 Produkte im Test
www.selbst.de



No. 5 Classic

mm	g	mm²	Ømm	Art.-No.
170	107	0,2 - 6 (24 - 10 AWG)		51003005



No. 6

1000 V
IEC: 60900



Working with voltage up to 1000 Volt*
Unit testing according to DIN EN 60900

- ▶ fully insulated, automatic wire stripper
- ▶ precise work with adjustable length stop (5 - 12 mm)
- ▶ space-saving thanks to locking mechanism

mm	g	mm²	Ømm	Art.-No.
170	105	0,2 - 6 (24 - 10 AWG)	-	51000006



* Tools with safety insulation are basic prerequisites for working on live wires and parts. Please always pay attention to the legal regulations and follow the corresponding safety advice!

Working Range Wire Strippers:

Outside diameter in mm	0,1270	0,1430	0,1600	0,1800	0,2020	0,2270	0,2550	0,2860	0,3210	0,3610	0,4050	0,4550	0,5110	0,5730	0,6440	0,7220	0,8120	0,9120	1,0240	1,15	1,29	1,45	1,63	1,83	2,05	2,30	2,59	2,91	3,26	3,67	4,11	4,62	5,19	5,83	6,54	7,35	8,25				
Cross section in mm²	0,0123	0,0161	0,0200	0,0252	0,0320	0,0400	0,0503	0,0646	0,0804	0,1020	0,1280	0,1630	0,2050	0,2590	0,3240	0,4120	0,5190	0,6530	0,8230	1,04	1,31	1,65	2,08	2,63	3,31	4,15	5,26	6,62	8,34	10,6	13,3	16,8	21,2	26,7	33,6	42,4	53,4				
AWG number	36	35	34	33	32	31	30	29	28	27	26	25	24	23	22	21	20	19	18	17	16	15	14	13	12	11	10	9	8	7	6	5	4	3	2	1	0				
Wire Stripper No. 5																																									
Wire Stripper No. 5 Classic																																									
Wire Stripper No. 6																																									
Wire Stripper No. 7 Magic																																									
Wire Stripper No. 7-F																																									
Precision Wire Stripper S																																									
ESD Precision Wire Stripper																																									
Fibre Optic Stripper																																									

Stripping Tools

Our stripping tools enable the safe and convenient stripping of a range of different cable types.

The flexible tools can even be used in areas difficult to access and always provide precise results.

Round Cable Stripper No. 13

Safe work with the ergonomic anti-slip handle shape

- ▶ for all standard round cables
- ▶ flush stripping, even in hard-to-reach areas
- ▶ it is not necessary to adjust the cutting depth

mm	g	mm ²	Ømm	Art.-No.
140	48	-	6 - 13	52000013



Now with
length stop

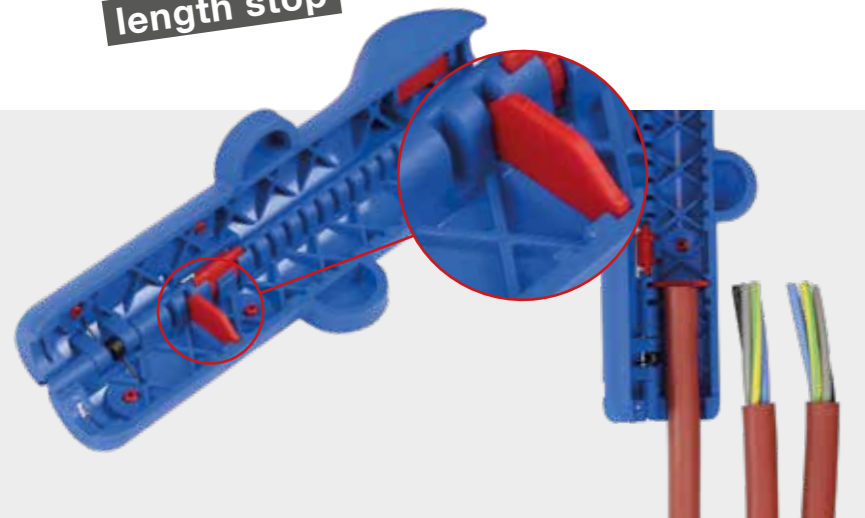

Round Cable Stripper No. 13 Classic

Safe work with the ergonomic anti-slip handle shape

- ▶ for all standard round cables
- ▶ flush stripping, even in hard-to-reach areas
- ▶ it is not necessary to adjust the cutting depth

mm	g	mm ²	Ømm	Art.-No.
120	44	-	8 - 13	52003013



1/2

Quadro-Stripper No. 16

Multifunctional with optimised cable routing

- ▶ circular and longitudinal cutting - stripping - cutting
- ▶ exchangeable hook blade, firmly locked in any position
- ▶ anti-slip handle shape

mm	g	mm ²	Ømm	Art.-No.
125	53	0,5 - 6 (20 - 10 AWG)	8 - 13	52000016

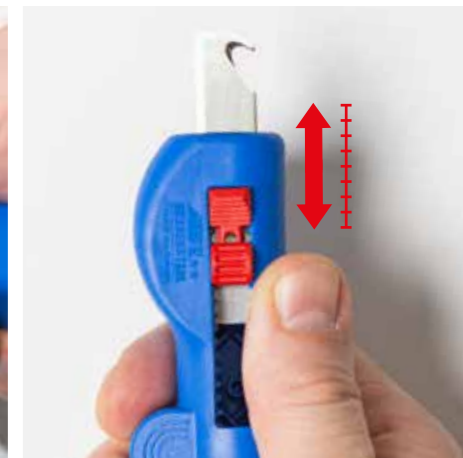

”

No. 16, 13 and 10 are particularly easy to handle thanks to their design. The ergonomic design ensures a safe gripping of the tool, so you won't slip off.

This makes daily work easier and also increases work safety.

Stephan Krampe
Managing Director
Krampe GmbH & Co.KG



Stripping Tools

Our stripping tools enable the safe and convenient stripping of a range of different cable types.

The flexible tools can even be used in areas difficult to access and always provide precise results.

Coax-Stripper No. 1 F Plus

Quick dismantling and stripping of coaxial cables with only one working step

- ▶ space-saving assembly and disassembly of F-connectors due to integrated open hexagon wrench with 11 mm width across flats
- ▶ gripping jaws for screwing F-connectors onto the cable
- ▶ changeable module inserts via click system



DBGM 20 2017 107 094



mm	g		Ømm	Art.-No.
125	47	for compression connectors	6,0 - 8,0	52001001
125	47	for F-screw connectors	6,0 - 8,0	52000001
125	47	for compression connectors*	4,0 - 5,0	52002001

*for mini coaxial cables

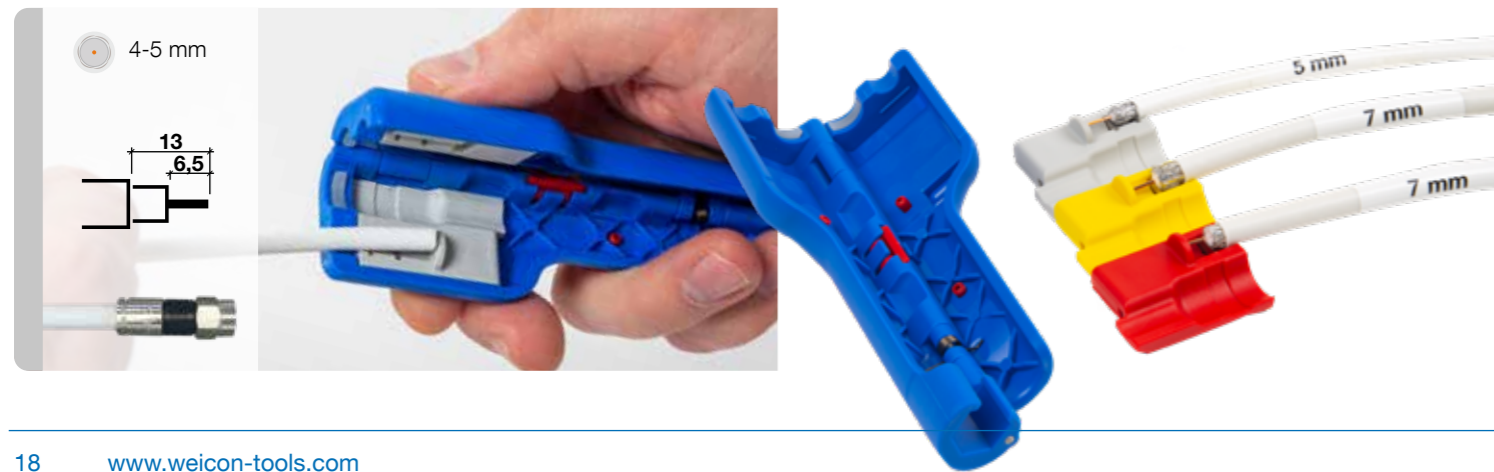

VIDEO



MODIFIED DESIGN

Coax-Stripper No. 2

Good handling due to ergonomic design

- ▶ two-level stripping of all common coaxial cables
- ▶ there is no need to adjust the cutting depth
- ▶ also suitable for flexible cables
- ▶ length scale (0 - 17 mm) integrated in the housing

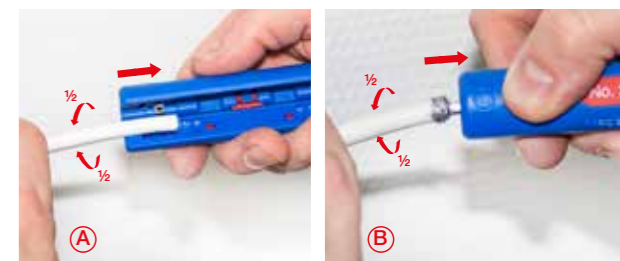

mm	g	mm ²	Ømm	Art.-No.
110	28	-	4,8 - 7,5	52000002

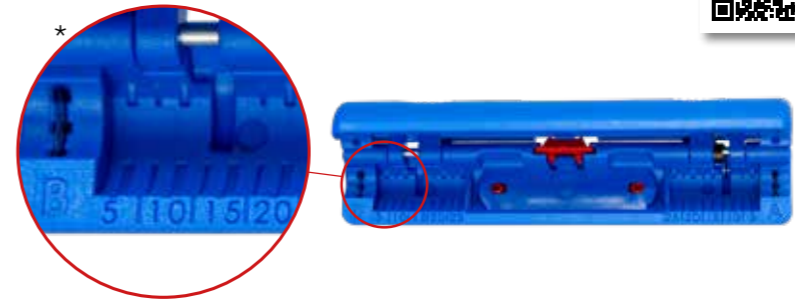

Combi-Coax No. 3

Parallel blade arrangement allows even faster stripping

- ▶ allows two- or three-level stripping of all common coaxial cables
- ▶ also suitable for flexible cables
- ▶ integrated and well accessible side cutter up to 8 mm Ø

mm	g	mm ²	Ømm	Art.-No.
125	55	-	4,8 - 7,5	52000003



Stripping Tools

Our stripping tools enable the safe and convenient stripping of a range of different cable types.

The flexible tools can even be used in areas difficult to access and always provide precise results.

Cat Cable-Stripper No. 10

Easy and space-saving stripping of data and network cables

- ▶ suitable for e.g. Cat5, Cat6, Cat7 twisted-pair cables (4,5 - 10 mm Ø)
- ▶ integrated length stop, adjustable to the required length
- ▶ safe work with the ergonomic anti-slip handle shape

mm	g	mm ²	Ømm	Art.-No.
140	48	-	4,5 - 10	52000010

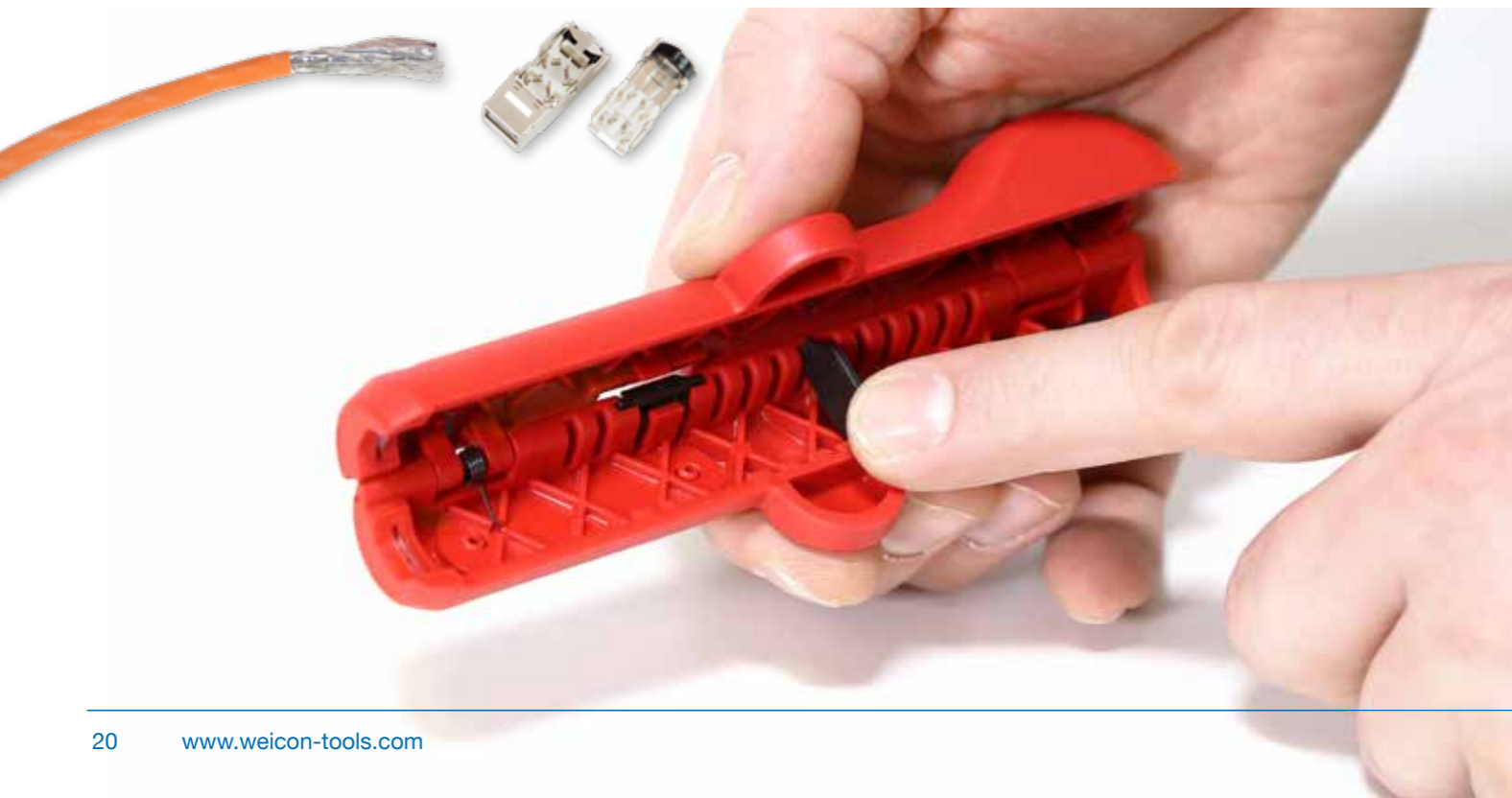
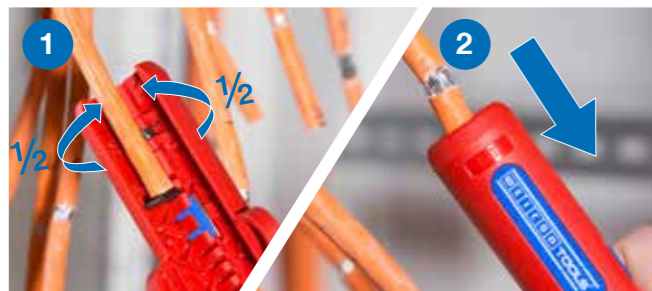

Stripper No. 2 Cat

Easy handling thanks to ergonomic shape

- ▶ for insulated PVC data cables (e.g. Cat5, Cat6, Cat7, twisted-pair cables) with a diameter of 4,5 - 10 mm
- ▶ adjusting the cutting depth manually is not necessary
- ▶ the precise adjustment of the blade removes the outer jacket accurately; with the second blade, the foil shield is slit open carefully and can then be easily removed

mm	mm ²	Ømm	Art.-No.
110	28	-	52002002

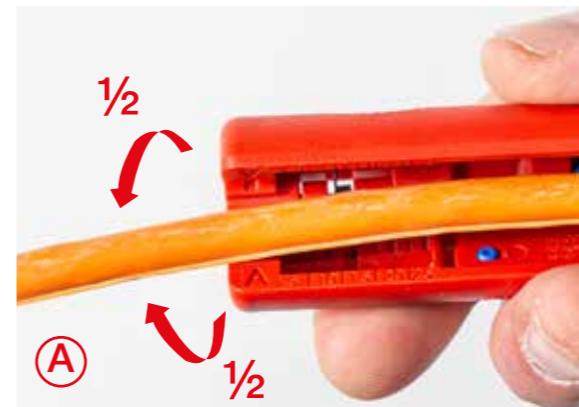

Multi-Purpose Strippers

WEICON TOOLS multi-purpose strippers provide various functions: circular and longitudinal stripping, dismantling and cutting.

This allows professional dismantling and stripping with just one tool.

Mini-Duo No. 150

Automatic wire stripper

- ▶ allows quick and accurate stripping
- ▶ precise work with integrated length scale
- ▶ easily accessible built-in side cutter for cables up to 6 mm²

mm	g	mm ²	Ømm	Art.-No.
160	112	0,5 - 6 (20 - 10 AWG)	-	51000150



Duo-Crimp No. 300

Stripping and crimping with just one tool

- ▶ insulation removal from 0,5 mm² to 6,0 mm²
- ▶ two crimping ranges are offered (0,5 - 2,5 mm² and 4,0 - 6,0 mm²) according to DIN 46228-2
- ▶ integrated, well accessible side cutter up to 6 mm²

mm	g	mm ²	Ømm	Art.-No.
160	116	0,5 - 6 (20 - 10 AWG)	-	51000300



VIDEO



Duo-Stripper No. 200

Professional dismantling and stripping

- ▶ quick and simple stripping from 0,5 mm² to 6,0 mm²
- ▶ dismantling: working range 4 - 28 mm Ø
- ▶ spare blade in the handle case

mm	g	mm ²	Ømm	Art.-No.
160	123	0,5 - 6 (20 - 10 AWG)	4 - 28	51000200

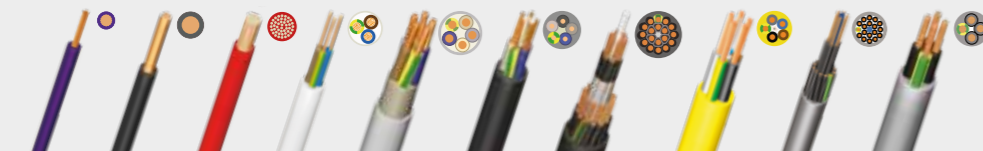

STRIPPING + CRIMPING



Multi-Purpose Strippers

WEICON TOOLS multi-purpose strippers provide various functions: circular and longitudinal stripping, dismantling and cutting.

This allows professional dismantling and stripping with just one tool.

Multi-Stripper No. 400

Multifunctional with 4 functions

- ▶ circular cutting - longitudinal cutting - stripping - cutting
- ▶ flush stripping, even in hard-to-reach areas
- ▶ safe and space-saving storage with closing clip

mm	g	mm ²	Ømm	Art.-No.
155	79	0,5 - 6 (20 - 10 AWG)	8 - 13	51000400



VIDEO

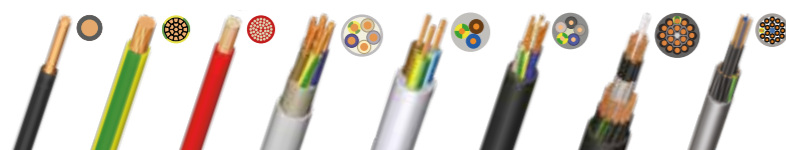

Data-Strip No. 30



Inner blade can be set to the insulation thickness

- ▶ removal of the outer insulation on data cables
- ▶ stripping of conductors and stranded wires, e.g. telephone lines
- ▶ precise stripping with adjustable length stop (3,5 - 14 mm)
- ▶ integrated, well accessible side cutter up to 8 mm Ø

mm	g	mm ²	Ømm	Art.-No.
125	60	0,05 - 0,5 (0,2 - 0,8 Ø) (30 - 20 AWG)	4 - 10	52000030



Ø 4 - 10 mm

1



3,5 - 14 mm

2



Ø 0,2 - 0,8 mm

3



Stripper No. 100



Universal tool for dismantling and stripping

- ▶ for many different cable types in building installation
- ▶ flush stripping on ceilings and walls
- ▶ allows circular and longitudinal stripping

mm	g	mm ²	Ømm	Art.-No.
140	74	0,5 - 16 (20 - 6 AWG)	4 - 13	51000100

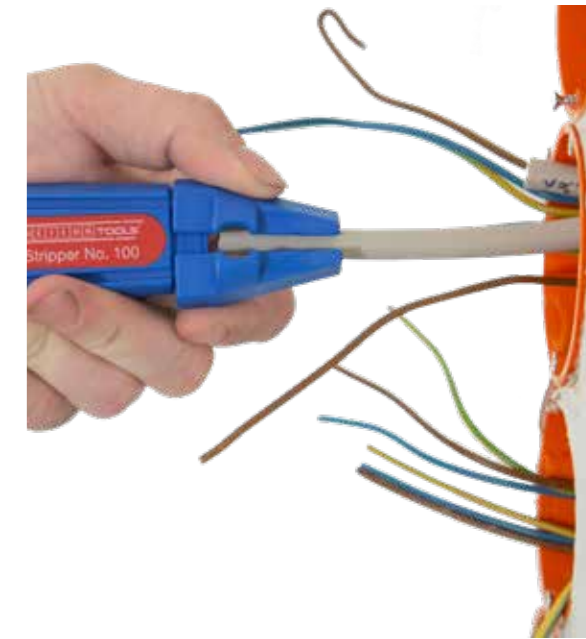
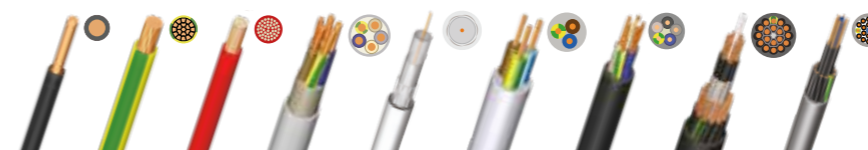

Tool Sets

With our tool sets, we can offer solutions for almost all industries and many different applications.

Starter-Set Pro

Ideal selection for home wiring

- ▶ Wire Stripper No. 5
- ▶ Coax-Stripper No. 2
- ▶ Cable Stripper No. S 4-28
- ▶ Round Cable Stripper No. 13

TOP SELECTION

mm	g	Art.-No.
Length x Width x Height		
255 x 210 x 60	575	52880001

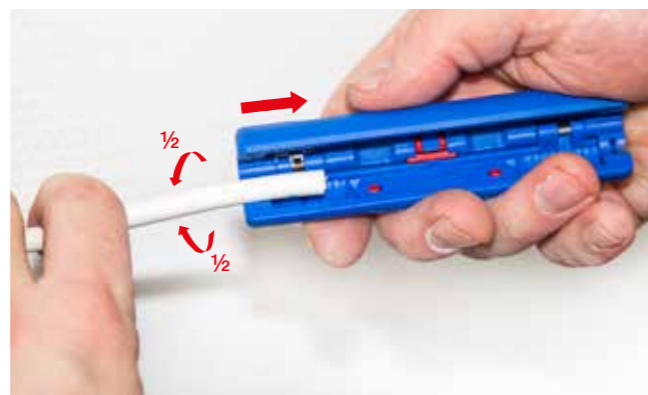

Crimp-Set Pro

All-round equipment for crimping with wire ends

- ▶ Duo-Crimp No. 300
- ▶ Wire Stripper No. 7 Magic
- ▶ high-quality shaker with 400 wire ends (0,5 - 2,5 mm²) according to DIN 46228

mm	g	Art.-No.
Length x Width x Height		
340 x 280 x 55	950	52880002



Shaker with wire ends

(DIN 46228)

Cross Section	Content	Colour
0,50 mm ²	50	white
0,75 mm ²	100	grey
1,00 mm ²	100	red
1,50 mm ²	100	black
2,50 mm ²	50	blue

Electrical Installation Sets

Industrial solutions for skilled trades:
Electrical | Heating/Plumbing | Customer Care | Automotive |
Refrigeration/Air Conditioning | Radio and Television | Home and
Hobby

Electrical Installation Set 1

- ▶ Duo-Crimp No. 300
- ▶ Round Cable Stripper No. 13
- ▶ professional crimping of wire ends
- ▶ two crimping ranges of 0,5 - 2,5 mm² and 4,0 - 6,0 mm²
- ▶ meets the requirements of DIN 46228-21: 1992-02 concerning the pull-off forces
- ▶ side cutter for single wires up to 6 mm²
- ▶ stripping of 0,5 - 6,0 mm²
- ▶ dismantling of all common round cables 6 - 13 mm
- ▶ flush dismantling e.g. at junction and distribution boxes

Art.-No.

52881001



Electrical Installation Set 3

- ▶ Wire Stripper No. 5
- ▶ Coax-Stripper No. 2
- ▶ automatic wire stripper for 0,2 - 6,0 mm²
- ▶ side cutter for single wires up to 2 mm ø
- ▶ adjustable length stop for defined distances at e.g. connection terminals
- ▶ two-level stripping of all common coaxial cables
- ▶ ideal for the installation of SAT systems with multi switches
- ▶ length scale integrated in the housing, e.g. for F-connectors
- ▶ adjustment of cutting depth not necessary

Art.-No.

52881003



Electrical Installation Set 2

- ▶ Wire Stripper No. 5
- ▶ Cable Stripper No. S 4-28
- ▶ automatic wire stripper for 0,2 - 6,0 mm²
- ▶ side cutter for single wires up to 2 mm ø
- ▶ adjustable length stop for defined distances at e.g. WAGO-Clamps
- ▶ cable stripper with working range of 4 - 28 mm
- ▶ adjustable cutting blade for round and longitudinal cutting
- ▶ ideal for the construction of switchboards

Art.-No.

52881002



Electrical Installation Set 4

- ▶ Wire Stripper No. 5
- ▶ Round Cable Stripper No. 13
- ▶ automatic wire stripper for 0,2 - 6,0 mm²
- ▶ side cutter for single wires up to 2 mm ø
- ▶ adjustable length stop for e.g. special distances
- ▶ dismantling of all common round cables from 6 - 13 mm
- ▶ flush dismantling, e.g. at junction and distribution boxes

Art.-No.

52881004



Special Tools

For a series of unusual applications, we provide you with special tools which meet these requirements. Whether it is the dismantling of large cable diameters, tools for the solar industry or working on high voltage cables, WEICON TOOLS has the solution!

Especially for the solar sector

Mini Solar No. 3

Special tools for dismantling and stripping of all common cables in the solar sector

- ▶ quick stripping of all common solar cables with outer diameters from 1,5 mm² to 6 mm²
- ▶ precise work with adjustable length stop (6 - 28 mm)
- ▶ integrated, well accessible side cutter up to 4 mm²

mm	g	mm ²	Ømm	Art.-No.
125	58	1,5 - 6 (15 - 9 AWG)	-	52002003



Wire Stripper No. 7 Solar

Special tools for dismantling and stripping of all common cables in the solar sector

- ▶ automatic wire stripper
- ▶ precise work with optical length scale (up to 26 mm)
- ▶ integrated, well accessible side cutter up to 3 mm Ø

mm	g	mm ²	Art.-No.
170	218	Solar cable 1,5 - 6 (15 - 9 AWG)	51002007



LSA Sensor No. 40

For the solderless, screwless and no-stripping inserting and simultaneously cutting of wire ends into LSA punch-down blocks

- ▶ with built-in retractable hook and unlocking blade
- ▶ for conductor diameters 0,35 - 0,9 mm and wire diameters 0,7 - 2,6 mm
- ▶ has a sensor for tracing the wire end position

mm	g	Ømm	Art.-No.
185	60	0,35 - 0,9	52000040



Cable Scissors No. 35

Cutting - stripping - crimping

- ▶ 2-component handles for increased safety
- ▶ high cutting performance
- ▶ blades made of special stainless steel

mm	g	Cu/Al	Cu/Al	Art.-No.
150	90	<35 mm ²	<50 mm ²	52000035

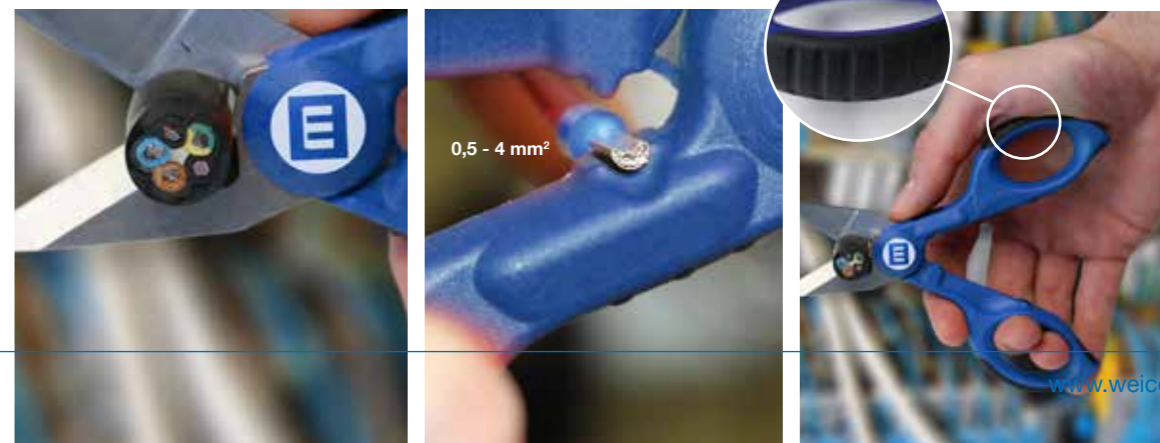

Special Tools

For a series of unusual applications, we provide you with special tools which meet these requirements. Whether it is the dismantling of large cable diameters, tools for the solar industry or working on high voltage cables, WEICON TOOLS has the solution!



Cable Stripper
H.D. No. 1000

Working with voltage up to 1000 Volt*
Unit testing according to DIN EN 60900

1000 V
IEC: 60900

- ▶ quick cutting of cables with multiple insulations
- ▶ conductor protection with the curved blade tip
- ▶ good transfer of force due to optimised handle shape

mm	g	Art.-No.
215	93	51001000

*Tools with safety insulation are basic prerequisites for working on live wires and parts.
Please always pay attention to the legal regulations and follow the corresponding safety advice!



Cable Stripper No. 4 - 29 Spiral **NEW**

round, longitudinal and circular cutting for soft and rigid cable insulations

- ▶ for all common round cables from 4,5 - 29 mm Ø
- ▶ cutting depth can be set comfortably from 0 - 3 mm with lockable control knob in 0,1 mm steps

mm	g	Ømm	Art.-No.
140	136	4,5 - 29	52000029



Dismantling Tool
No. 25

For convenient longitudinal and circular cuts

- ▶ safe working thanks to concealed blade
- ▶ wire protection thanks to rounded blade tip
- ▶ easy working even in low temperatures
- ▶ precise, durable, replaceable turning blade

mm	g	Ømm	Art.-No.
210	163	>25 mm	52000025



Multi-Opener



The ideal tool for the gentle opening of sensitive equipment and dismantling of clipped housings

- ▶ no scratching of sensitive surfaces
- ▶ dissipative ESD material protects against electrostatic discharge
- ▶ flexible fibreglass-reinforced polyamide
- ▶ stainless steel blade to remove adhesive residues

mm	g	Surface Resistance	Art.-No.
180	22	approx. 10 ⁹ Ω	52800000

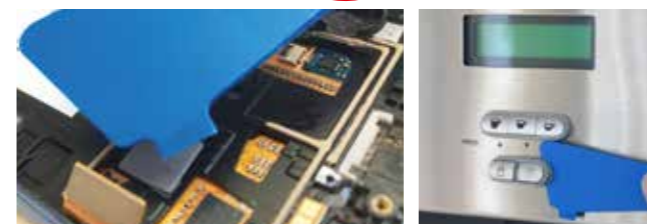

Easy Opener®



Special tool for the gentle disassembly of sensitive components without damaging the material

- ▶ ideal for loosening switches, luminaires or similar components
- ▶ flexible and stable at the same time
- ▶ three surfaces with different material thickness

mm	g	Art.-No.
180	22	52800001



Our
DIY TIP!



Spare Parts & Selling Aids

Spare Parts for Tools

Art. No.	Name	PU	
50100002	Spare blade for Cable Stripper series S 4 - 28 <i>Inner blade</i>	1	
50100001	Spare blade for Cable Strippers <i>Inner blade</i>	1	
51100008	Spare blade for No. 200 <i>Inner blade</i>	1	
51100002	Spare blade set No. 5/No. 6 <i>2 blades + 1 screw</i>	1	
51100006	Spare blade set No. 7 Magic <i>2 blades + 4 screws</i>	1	
51100007	Spare blade set No. 7-F <i>2 blades + 4 screws</i>	1	
51100005	Spare blade set No. 7 Solar	1	
52953030	Spare blade set No. 30 Data-Strip <i>1 blade + adjusting screw</i>	1	
51953020	Spare blade set for No. 150 / No. 200 / No. 300	1	
52953020	Spare blade for Dismantling Tool No. 25 <i>Double edge blade</i>	1	
52953050	Spare blade for Cable Stripper 4-29 Spiral	1	
52953040	Hook knife for No. 16 <i>1 hook knife 1 slider + 1 screw</i>	1	
52100008	Inserts for No.1 F Plus 6/4	6	
52100009	Inserts for No.1 F Plus 6.5/6.5	6	
52100010	Inserts for No.1 F Plus 6/4 <i>*for mini coaxial cables</i>	6	



Stickers

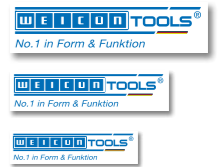

Poster

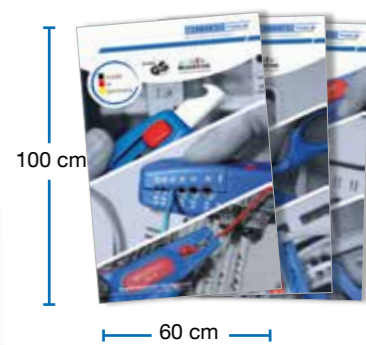

Foam Display without tools
50951199
Example: 12x Dismantler

Foam Display without tools
50951198
Example: 6x Wire Stripper

WEICON TOOLS® Cable Overview

The cable types shown in the table below are only meant to give an overview of the potential application areas of our tools. WEICON TOOLS can also be used on similar cable types in many cases, of course. Furthermore, the application suggestions depend on the material, application area and working range. Our tool recommendation is only a suggestion due to the various materials used by cable manufacturers.

Cable	Name	Example	Suggested application Dismantling	Suggested Application Stripping
	PVC - coated conductor	(N)YM	All Cable Strippers, No. 13, No. 16, No. 100, No. 200, No. 400, No. 7 Magic	No. S 4 - 28 Multi, No. 5, No. 6, No. 7 Magic, No. 7-F, No. 16, No. 100, No. 200, No. 400
	PVC - sheathed cable for low mechanical loads	H05VV-F	All Cable Strippers (working range from 4 mm), No. 3, No. 200, No. 7 Magic	No. 2, No. 3, No. S 4 - 28 Multi, No. 5, No. 6, No. 7 Magic, No. 7-F, No. 16, No. 100, No. 200, No. 400,
	Rubber tube conductor for light mechanical loads	H05RR-F	All Cable Strippers, No. 7 Magic, No. 13, No. 16, No. 100, No. 200, No. 400	No. S 4 - 28 Multi, No. 5, No. 6, No. 7 Magic, No. 7-F, No. 16, No. 100, No. 200, No. 400
	Rubber - control line	(N)FLGöu	All Cable Strippers, No. 7 Magic, No. 13, No. 16, No. 100, No. 200, No. 400,	No. S 4 - 28 Multi, No. 5, No. 6, No. 7 Magic, No. 7-F, No. 16, No. 100, No. 200, No. 400
	PVC - construction cables	XYMM K3	All Cable Strippers, No. 7 Magic, No. 13, No. 16, No. 100, No. 200, No. 400	No. S 4 - 28 Multi, No. 5, No. 6, No. 7 Magic, No. 7-F, No. 16, No. 100, No. 200, No. 400
	PVC - control line		All Cable Strippers, No. 7 Magic, No. 13, No. 16, No. 100, No. 200, No. 400,	No. S 4 - 28 Multi, No. 5, No. 6, No. 7 Magic, No. 7-F, No. 16, No. 100, No. 200, No. 400
	PVC - control line oil resistant	73H05VV5-F	All Cable Strippers, No. 7 Magic, No. 13, No. 16, No. 100, No. 200, No. 400,	No. S 4 - 28 Multi, No. 5, No. 6, No. 7 Magic, No. 7-F, No. 16, No. 100, No. 200, No. 400
	PVC - motor connection cables	SLM 0,6/1 kV	All Cable Strippers, No. 7 Magic, No. 13, No. 16, No. 100, No. 200, No. 400,	No. S 4 - 28 Multi, No. 5, No. 6, No. 7 Magic, No. 7-F, No. 16, No. 100, No. 200, No. 400
	PVC - sheathed cable for medium mechanical loads	H05VV-F	All Cable Strippers, No. 7 Magic, No. 13, No. 16, No. 100, No. 200, No. 400,	No. S 4 - 28 Multi, No. 5, No. 6, No. 7 Magic, No. 7-F, No. 16, No. 100, No. 200, No. 400
	PVC insulated high voltage cables, single and multi-core cables	E-YY	No. 25, No. 1000	---
	PVC insulated cables with aluminium conductor	E-AYY	No. 25, No. 1000	---
	PVC insulated telecommunications sheathed wires 0,6 mm	YYSch	No. 7 Magic	No. 5, No. 6, No. 7 Magic, No. 7-F, Precision Wire Stripper S/ESD
	PVC insulated telecommunications sheathed wires 0,8 mm	YR	No. 7 Magic	No. 5, No. 6, No. 7 Magic, No. 7-F, Precision Wire Stripper S/ESD
	PVC - single wire core conductor	H05V-U	---	No. S 4 - 28 Multi, No. 5, No. 6, No. 7 Magic, No. 7-F, No. 16, No. 100, No. 200, No. 400
	PVC - multiple wire core conductor	H07V-R	---	No. S 4 - 28 Multi, No. 5, No. 6, No. 7 Magic, No. 7-F, No. 100
	PVC - fine wire core conductor	H05V-K	---	No. S 4 - 28 Multi, No. 5, No. 6, No. 7 Magic, No. 7-F, No. 16, No. 100, No. 200, No. 300, No. 400, Precision Wire Stripper S/ESD
	PVC - wiring conductor fine wire	H07V-K	---	No. S 4 - 28 Multi, No. 5, No. 6, No. 7 Magic, No. 7-F, No. 16, No. 100, No. 200, No. 300, No. 400, Precision Wire Stripper S/ESD

Cable	Name	Example	Suggested application Dismantling	Suggested Application Stripping
	PVC ignition cable e.g. in the vehicle industry	AYZL	---	No. 2, No. 3
	Coaxial cables for the transmission of high frequency signals and conductors	RG 59 B/U	No. 1, No. 2, No. 3, No. 100	No. 1, No. 2, No. 3, No. 100
	Coaxial cables (SAT compatible)	2YALGY	No. 1, No. 2, No. 3, No. 100	No. 1, No. 2, No. 3, No. 100
	Special PVC loud speaker cable	26 LFZ-XY	---	No. 7 Magic, No. 7-F
	PVC twin conductor	(H)03VH-H	---	No. 7 Magic, No. 7-F
	PVC flat twin and earth cable		No. 7-F	No. 7-F
	Flat rubber cables for medium mechanical loads		No. 7-F	No. 7-F
	Solar cables	H1Z2Z2-K	Mini-Solar No. 3, No. 7 Solar	Mini-Solar No. 3, No. 7 Solar
	Installation cables for fire alarm systems	JB-Y(ST)Y	No. 2 Cat, No. 10, No. 30	No. 30
	Installation cables for telecommunications systems	F-vYAY	No. 2 Cat, No. 10, No. 30	No. 30, Precision Wire Stripper S/ESD
	Electronic - control lines	LiYY	No. 2 Cat, No. 10, No. 30	No. 30, Precision Wire Stripper S/ESD
	Installation cables for industry electronics	JE-Y(ST)Y Bd	No. 2 Cat, No. 10, No. 30	No. 30, Precision Wire Stripper S/ESD
	BUS cable		No. 2 Cat, No. 10, No. 30	No. 30
	Patch cable with film shield for local networks	LAN 200flex	No. 2 Cat, No. 10, No. 30	No. 30
	Data cable (Cat 7)	LAN 1000	No. 2 Cat, No. 10, No. 30	No. 30
	Rubber core conductor with higher heat resistance	A07RN-R	---	No. 2, No. 3
	Silicone core conductor	SiF	---	No. 2, No. 3
	Fibre optic		---	Fibre Optic Stripper

WEICON TOOLS® Application Examples



PHOTOVOLTAIC/SOLAR

Wire Stripper No. 7 Solar
Automatic stripping of solar cables



Mini-Solar No. 3
Stripping of solar cables



KITCHEN/LIVING ROOM

Round Cable Stripper No. 13
Stripping on cavity wall boxes



Wire Stripper No. 5
Stripping of all common stranded and solid wires



DIY/WORKSHOP

Duo-Crimp No. 300
Crimping wire end ferrules



Multi-Stripper No. 400
Wire stripping and dismantling



Precision Wire Stripper S
For thin wires and conductors



LIVING ROOM

Coax-Stripper No. 1 F Plus
Stripping coaxial cables



LSA Sensor No. 40
Installation network socket



Stripper No. 2 Cat
Stripping data cables (e.g. CAT 7)



UTILITY ROOM

Cable Stripper S 4-28
Removing the outer sheath, e.g. NYM



Wire Stripper No. 6
Stripping of all common stranded and solid wires



Fibre Optic Stripper
Removing the coating of fibre optic cables



HEATING/AIR CONDITIONING

Wire Stripper No. 7 Magic
Wire stripping and dismantling



Quadro-Stripper No. 16
Wire stripping and dismantling



WEICON TOOLS® Certificates

ZERTIFIKAT

für eine Fertigungsstätte von Erzeugnissen, die mit einem TÜV NORD CERT Sicherheitszeichen versehen werden

Weicon GmbH & Co. KG
Königsberger Straße 255
48157 Münster
Deutschland

Fertigungsstätte: Weicon GmbH & Co. KG
Königsberger Straße 255
48157 Münster
Deutschland

Erzeugnisse: Absoluterwerkzeuge

Tag des Besuchs: 05.06.2020

Ergebnis der Besichtigung:
Der Antragsteller konnte nachweisen, dass die Fertigungsstätte der aufgeführten Erzeugnisse technisch so eingerichtet und geleitet ist, dass eine gleichmäßige Herstellung gewährleistet ist.

Registrier-Nr. 44 786 131137-001
Prüfbericht-Nr. 3526 3763
Aktuelle-Nr. 2-4-853/02

Gültigkeit
von 2020-06-02
bis 2021-06-01

TÜV NORD CERT GmbH
Zertifizierungsstelle Konsumgüter
TÜV NORD CERT GmbH Langenmarkstraße 20 45141 Essen www.tuv-nord-cert.de product@tuv-nord.de



Further certificates
on request!



Management
System
ISO 9001:2015
ISO 14001:2015

www.tuv.com
ID 9108636595

PRIVATE LABEL TOOLS

We also provide the opportunity to design the tools in a variety of colour combinations and individually with your company print/logo.

We would be pleased to submit a detailed offer.



individual colour
combinations



WEICON TOOLS® Product Overview

CABLE STRIPPERS



Cable Stripper No. S 4 - 28
Art.-No. 50055328



Cable Stripper No. S 4 - 28 Multi
Art.-No. 50057328

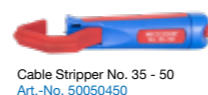

Cable Stripper No. 35 - 50
Art.-No. 50050450

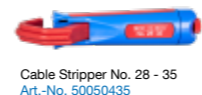

Cable Stripper No. 28 - 35
Art.-No. 50050435



Cable Stripper No. 4 - 28 G
Art.-No. 50054428



Cable Stripper No. 4 - 28 H
Art.-No. 50054328



Cable Stripper No. 4 - 16
Art.-No. 50050116



Cable Stripper No. 8 - 27
Art.-No. 50050227



Cable Stripper No. C 4 - 16
Art.-No. 50053116



Cable Stripper No. C 8 - 27
Art.-No. 50053227



Cable Stripper No. C 4 - 28
Art.-No. 50053328

WIRE STRIPPERS



Wire Stripper No. 5
Art.-No. 51000005



Wire Stripper No. 5 Classic
Art.-No. 51003005



Wire Stripper No. 6
Art.-No. 51000006



ESD Precision Wire Stripper
Art.-No. 51001002



Wire Stripper No. 7 Magic
Art.-No. 51000007



Wire Stripper No. 7-F
Art.-No. 51001007



Precision Wire Stripper S
Art.-No. 51000002



Fibre Optic Stripper
Art.-No. 51002002

STRIPPING TOOLS

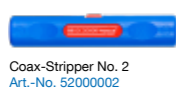

Coax-Stripper No. 2
Art.-No. 52000002



Stripper No. 2 Cat
Art.-No. 52002002



Cat Cable-Stripper No. 10
Art.-No. 52000010

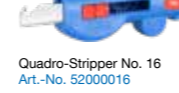

Quadro-Stripper No. 16
Art.-No. 52000016



Combi-Coax No. 3
Art.-No. 52000003



Round Cable Stripper No. 13
Art.-No. 52000013



Round Cable Stripper No. 13 Classic
Art.-No. 52003013



No. 1 F Plus for screw connectors
Art.-No. 52000001



No. 1 F Plus F-compression connectors
Art.-No. 52001001



No. 1 F Plus F-compression connectors
for mini coaxial cables
Art.-No. 52002001

Cable Scissors No. 35.....p. 31
Cable Stripper H. D. No. 1000.....p. 32
Cable Stripper No. 28 - 35.....p. 9
Cable Stripper No. 35 - 50.....p. 9
Cable Stripper No. 4 - 16.....p. 9
Cable Stripper No. 4 - 28 G.....p. 9
Cable Stripper No. 4 - 28 H.....p. 9
Cable Stripper No. 8 - 27.....p. 9

Cable Stripper No. C 4 - 16.....p. 9
Cable Stripper No. C 4 - 28.....p. 9
Cable Stripper No. C 8 - 27.....p. 9
Cable Stripper No. S 4 - 28.....p. 7
Cable Stripper No. S 4 - 28 Multi.....p. 7
Cable Stripper No. S 4 - 29 Spiral.....p. 32
Cat Cable-Stripper No. 10.....p. 22
Coax-Stripper No. 1 F Plus.....p. 18

Coax-Stripper No. 2.....p. 19
Combi-Coax No. 3.....p. 19
Crimp-Set Pro.....p. 27
Data-Strip No. 30.....p. 25
Dismantling Tool No. 25.....p. 25
Duo-Crimp No. 300.....p. 32
Duo-Stripper No. 200.....p. 22
Easy Opener.....p. 33

MULTI-PURPOSE STRIPPERS



Duo-Crimp No. 300
Art.-No. 51000300



Mini-Duo No. 150
Art.-No. 51000150



Duo-Stripper No. 200
Art.-No. 51000200



Multi-Stripper No. 400
Art.-No. 51000400



Stripper No. 100
Art.-No. 51000100



Data-Strip No. 30
Art.-No. 52000030

SETS



Starter-Set Pro
Art.-No. 52880001



Crimping-Set Pro
Art.-No. 52880002



Electrical Installation Set 1
Art.-No. 52881001



Electrical Installation Set 2
Art.-No. 52881002



Electrical Installation Set 3
Art.-No. 52881003



Electrical Installation Set 4
Art.-No. 52881004

SPECIAL TOOLS



Cable Stripper H. D. No. 1000
Art.-No. 51001000



Dismantling Tool No. 25
Art.-No. 52000025



LSA Sensor No. 40
Art.-No. 52000040

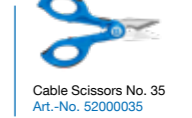

Cable Scissors No. 35
Art.-No. 52000035



Mini-Solar No. 3
Art.-No. 52002003



Wire Stripper No. 7 Solar
Art.-No. 51002007

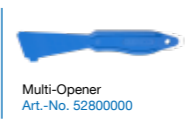

Multi-Opener
Art.-No. 52800000

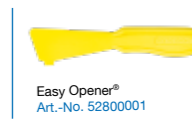

Easy Opener®
Art.-No. 52800001



Cable Stripper No. 4 - 29 Spiral
Art.-No. 52000029

Electrical Installation Sets 1/2/3/4.....p. 28
ESD Precision Wire Stripper.....p. 15
Fibre Optic Stripper.....p. 15
Mini-Duo No. 150.....p. 31
Mini-Solar No. 3.....p. 30
Multi-Opener.....p. 33
Multi-Stripper No. 400.....p. 24

Precision Wire Stripper S.....p. 14
Quadro-Stripper No. 16.....p. 17
Round Cable Stripper No. 13.....p. 16
Round Cable Stripper No. 13 Classic.....p. 16
Starter-Set Pro.....p. 26
Stripper No. 100.....p. 25
Stripper No. 2 Cat.....p. 21
Wire Stripper No. 5.....p. 10

Wire Stripper No. 5 Classic.....p. 11
Wire Stripper No. 6.....p. 11
Wire Stripper No. 7 Magic.....p. 12
Wire Stripper No. 7 Solar.....p. 30
Wire Stripper No. 7-F.....p. 13

Note: Work with WEICON TOOLS is only permitted on zero-potential cables and conductors.

Note: Work with WEICON TOOLS is only permitted on zero-potential cables and conductors.

WEICON TOOLS®

No. 1 in Form & Funktion



MESSERSTAHL
Qualität aus Solingen



WEICON GmbH & Co. KG
(Headquarters)
Germany
phone +49 (0) 251 9322 0
info@weicon.de

WEICON Middle East L.L.C.
United Arab Emirates
phone +971 4 880 25 05
info@weicon.ae

WEICON Inc.
Canada
phone +1 877 620 8889
info@weicon.ca
www.weicon.ca

WEICON Kimya Sanayi Tic. Ltd. Şti.
Turkey
phone +90 (0) 212 465 33 65
info@weicon.com.tr
www.weicon.com.tr

WEICON Romania SRL
Romania
phone +40 (0) 3 65 730 763
office@weicon.com

WEICON SA (Pty) Ltd
South Africa
phone +27 (0) 21 709 0088
info@weicon.co.za

WEICON South East Asia Pte Ltd
Singapore
phone (+65) 6710 7671
info@weicon.com.sg

WEICON Czech Republic s.r.o.
Czech Republic
phone +42 (0) 417 533 013
info@weicon.cz

WEICON Ibérica S.L.
Spain
phone +34 (0) 914 7997 34
info@weicon.es

WEICON Italia S.r.L.
Italy
phone +39 (0) 329 235 9592
info@weicon.it

www.weicon-tools.com

Art.-No. 50900002

X-ON Electronics

Largest Supplier of Electrical and Electronic Components

Click to view similar products for [Wire Stripping & Cutting Tools](#) category:

Click to view products by [Weicon](#) manufacturer:

Other Similar products are found below :

[6-690504-4](#) [693855-1](#) [813066-2](#) [844764-5](#) [844765-5](#) [1-240644-7](#) [1-240642-7](#) [133900-001](#) [1424635-1](#) [1424650-1](#) [1440-0013-84](#) [1-458031-5](#)
[1-458030-5](#) [1490498-1](#) [1755](#) [2-539783-7](#) [1633578-3](#) [1-844765-9](#) [240825-8](#) [CST596711](#) [458031-9](#) [462839-1](#) [4-690504-2](#) [406339-3](#) [L-4994](#)
[45-265](#) [453653-1](#) [45-418](#) [455177-1](#) [455671-4](#) [45-637](#) [458144-8](#) [462007-1](#) [462548-1](#) [464661-1](#) [224186-1](#) [809687-1](#) [852080-2](#) [856695-8](#)
[458030-1](#) [679326-7](#) [605744-1](#) [690784-2](#) [844765-6](#) [T147A](#) [TE3SA](#) [690464-4](#) [63820-0030](#) [378185](#) [568680-1](#)