

**General Description**

2N65M / A G the silicon N-channel Enhanced VDMOSFETS, is obtained by the self-aligned planar Technology which reduce the conduction loss, improve switching performance and enhance the avalanche energy. The transistor can be used in various power switching circuit for system miniaturization and higher efficiency. The package form is TO-252, which accords with the RoHS standard.

V_{DSS}	650	V
I_D	2	A
$P_D (T_C=25^\circ\text{C})$	35	W
$R_{DS(ON)type}$	3.8	Ω

Features

- Fast Switching
- Low Gate Charge and R_{dson}
- Low Reverse transfer capacitances
- 100% Single Pulse avalanche energy Test

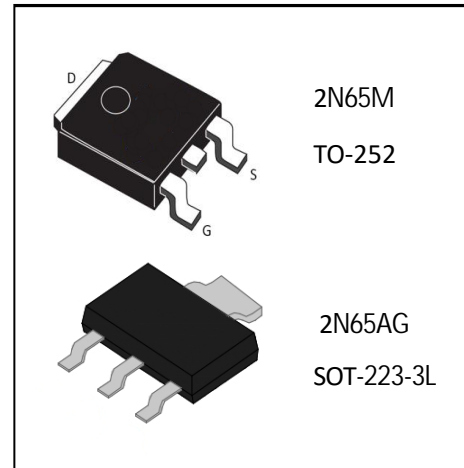
**Applications**

- Power switch circuit of adaptor and charger.

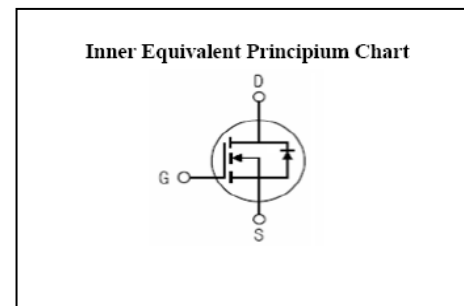
**Absolute** ($T_C=25^\circ\text{C}$ unless otherwise specified)

Symbol	Parameter	Rating	Units
V_{DSS}	Drain-to-Source Voltage	650	V
I_D	Continuous Drain Current	2.0	A
	Continuous Drain Current $T_C = 100^\circ\text{C}$	1.45	A
I_{DM}^{a1}	Pulsed Drain Current	8.0	A
V_{GS}	Gate-to-Source Voltage	± 30	V
E_{AS}^{a2}	Single Pulse Avalanche Energy	68	mJ
E_{AR}^{a1}	Avalanche Energy ,Repetitive	6.4	mJ
I_{AR}^{a1}	Avalanche Current	1.1	A
dv/dt^{a3}	Peak Diode Recovery dv/dt	5.0	V/ns
P_D	Power Dissipation	35	W
	Derating Factor above 25°C	0.28	W/ $^\circ\text{C}$
T_J, T_{stg}	Operating Junction and Storage Temperature Range	150, -55 to 150	$^\circ\text{C}$
T_L	Maximum Temperature for Soldering	300	$^\circ\text{C}$

Caution Stresses greater than those in the "Absolute Maximum Ratings" may cause permanent damage to the device

**Electrical Characteristics** ($T_c=25^\circ\text{C}$ unless otherwise specified)

OFF Characteristics						
Symbol	Parameter	Test Conditions	Rating			Units
			Min.	Typ.	Max.	
V_{DSS}	Drain to Source Breakdown Voltage	$V_{GS}=0V, I_D=250\mu A$	650	--	--	V
$\Delta BV_{DSS}/\Delta T_J$	Bvdss Temperature Coefficient	$I_D=250\mu A, \text{Reference } 25^\circ\text{C}$	--	0.60	--	V/ $^\circ\text{C}$
I_{DSS}	Drain to Source Leakage Current	$V_{DS}=650V, V_{GS}=0V, T_a=25^\circ\text{C}$	--	--	1	μA
		$V_{DS}=520V, V_{GS}=0V, T_a=125^\circ\text{C}$	--	--	100	
$I_{GSS(F)}$	Gate to Source Forward Leakage	$V_{GS}=+30V$	--	--	100	nA
$I_{GSS(R)}$	Gate to Source Reverse Leakage	$V_{GS}=-30V$	--	--	-100	nA

ON Characteristics						
Symbol	Parameter	Test Conditions	Rating			Units
			Min.	Typ.	Max.	
$R_{DS(ON)}$	Drain-to-Source On-Resistance	$V_{GS}=10V, I_D=1.0A$	--	3.8	4.5	Ω
$V_{GS(TH)}$	Gate Threshold Voltage	$V_{DS}=V_{GS}, I_D=250\mu A$	2.0	--	4.0	V
Pulse width $t_p \leq 380\mu s, \delta \leq 2\%$						

Dynamic Characteristics						
Symbol	Parameter	Test Conditions	Rating			Units
			Min.	Typ.	Max.	
g_{fs}	Forward Transconductance	$V_{DS}=15V, I_D=2A$	--	2.6	--	S
C_{iss}	Input Capacitance	$V_{GS}=0V, V_{DS}=25V$ $f=1.0\text{MHz}$	--	290	--	pF
C_{oss}	Output Capacitance		--	31	--	
C_{rss}	Reverse Transfer Capacitance		--	6	--	

Resistive Switching Characteristics						
Symbol	Parameter	Test Conditions	Rating			Units
			Min.	Typ.	Max.	
$t_{d(ON)}$	Turn-on Delay Time	$I_D=2.0A, V_{DD}=325V$ $V_{GS}=10V, R_G=9.1\Omega$	--	8	--	ns
t_r	Rise Time		--	6	--	
$t_{d(OFF)}$	Turn-Off Delay Time		--	30	--	
t_f	Fall Time		--	11	--	
Q_g	Total Gate Charge	$I_D=2.0A, V_{DD}=325V$ $V_{GS}=10V$	--	9	--	nC
Q_{gs}	Gate to Source Charge		--	1.5	--	
Q_{gd}	Gate to Drain ("Miller") Charge		--	4.0	--	



Source-Drain Diode Characteristics						
Symbol	Parameter	Test Conditions	Rating			Units
			Min.	Typ.	Max.	
I_S	Continuous Source Current (Body Diode)		--	--	2	A
I_{SM}	Maximum Pulsed Current (Body Diode)		--	--	8	A
V_{SD}	Diode Forward Voltage	$I_S=2.0A, V_{GS}=0V$	--	--	1.5	V
t_{rr}	Reverse Recovery Time	$I_S=2.0A, T_J=25^\circ C$	--	425	--	ns
Q_{rr}	Reverse Recovery Charge	$di_F/dt=100A/us, V_{GS}=0V$	--	1140	--	nC
Pulse width $t_p \leq 380\mu s, \delta \leq 2\%$						

Thermal Characteristics

Symbol	Parameter	Typ.	Units
$R_{\theta JC}$	Junction-to-Case	3.57	$^\circ C/W$
$R_{\theta JA}$	Junction-to-Ambient	62	$^\circ C/W$

a¹: Repetitive rating; pulse width limited by maximum junction temperature

a²: $L=10.0mH, I_D=3.7A, \text{Start } T_J=25^\circ C$

a³: $I_{SD}=2A, di/dt \leq 100A/us, V_{DD} \leq BV_{DS}, \text{Start } T_J=25^\circ C$

Test Circuits

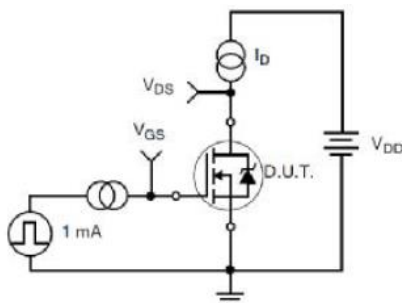

Figure 17. Gate Charge Test Circuit

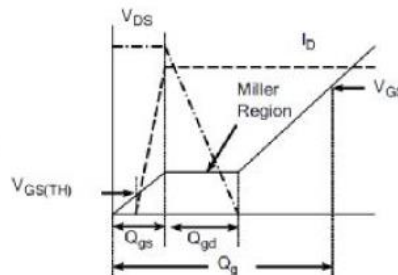

Figure 18. Gate Charge Waveform

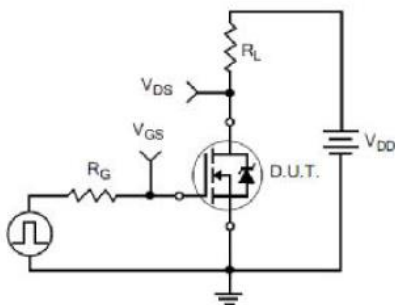

Figure 19. Resistive Switching Test Circuit

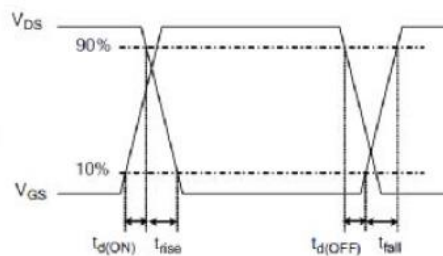

Figure 20. Resistive Switching Waveforms



Characteristics Curves

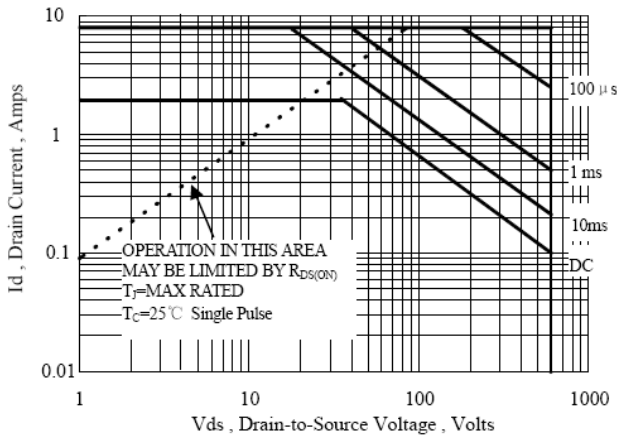

Figure 1 Maximum Forward Bias Safe Operating Area

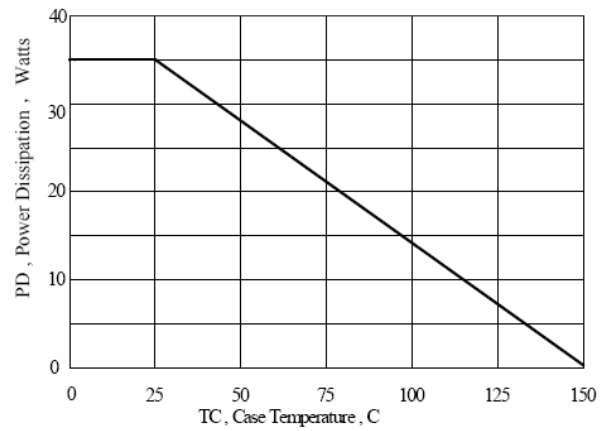

Figure 2 Maximum Power Dissipation vs Case Temperature

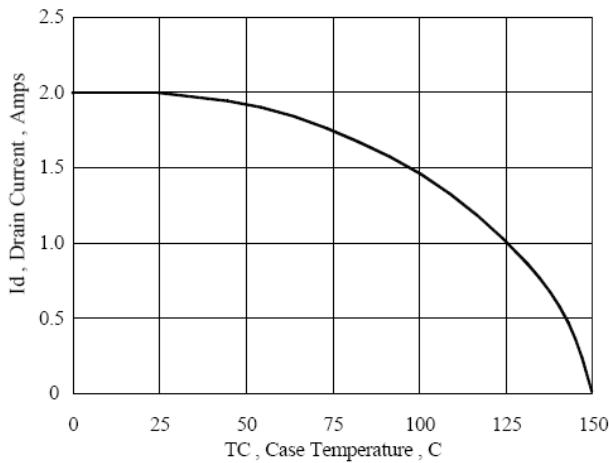

Figure 3 Maximum Continuous Drain Current vs Case Temperature

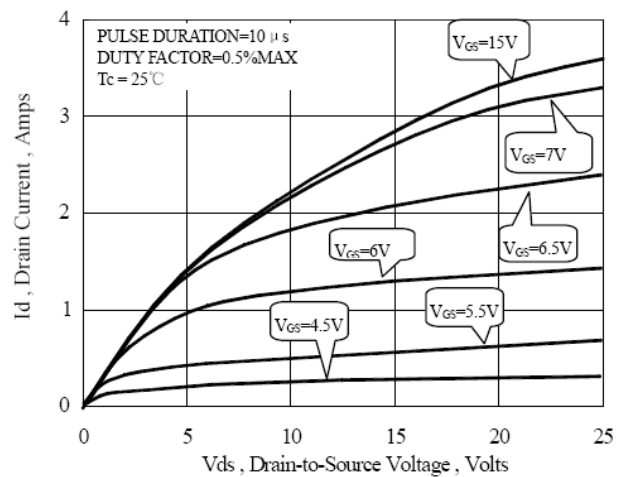

Figure 4 Typical Output Characteristics

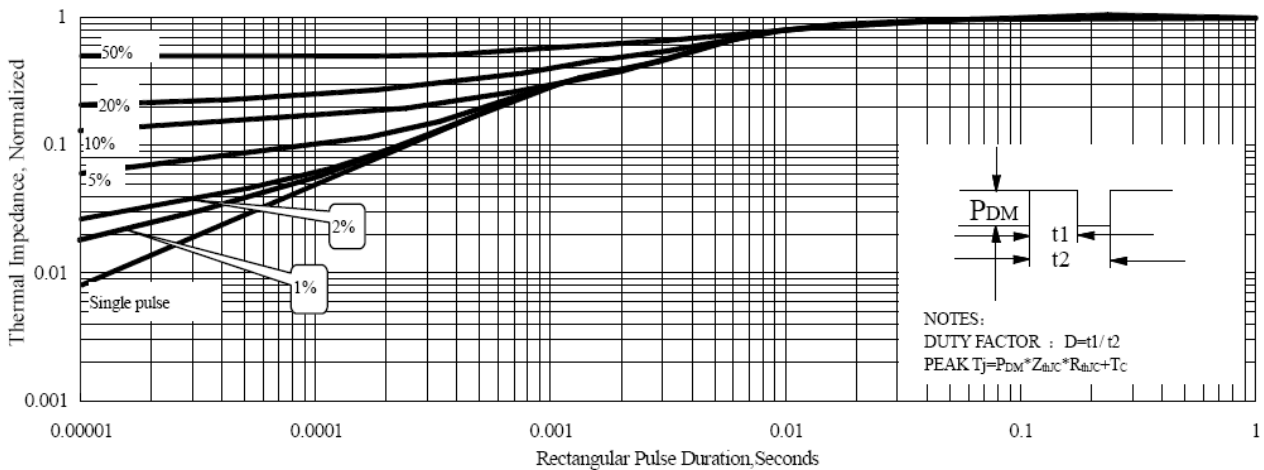

Figure 5 Maximum Effective Thermal Impedance, Junction to Case

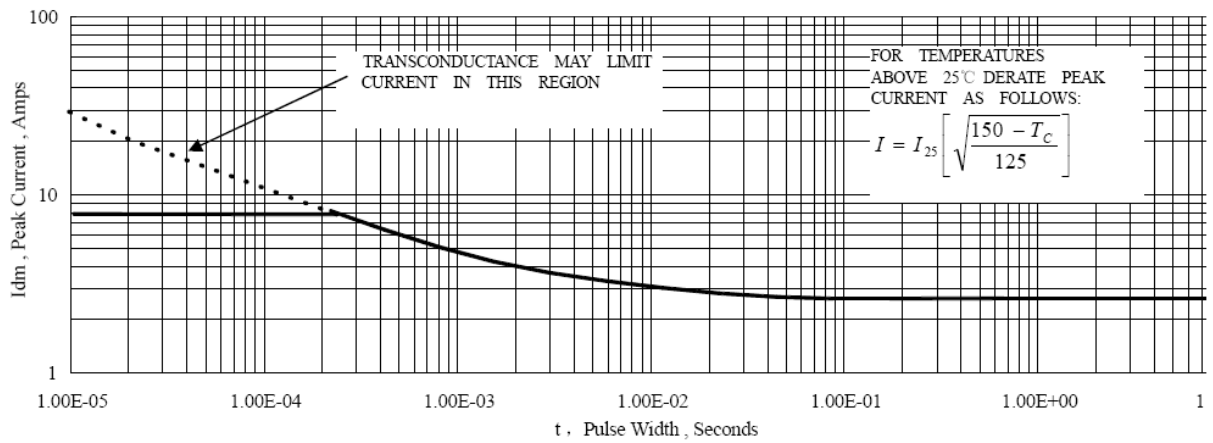

Figure 6 Maximum Peak Current Capability

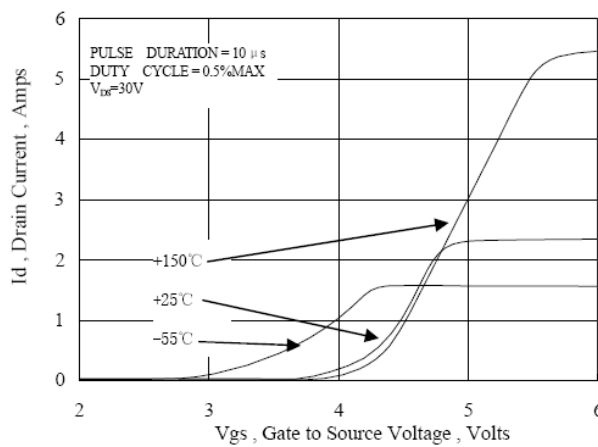

Figure 7 Typical Transfer Characteristics

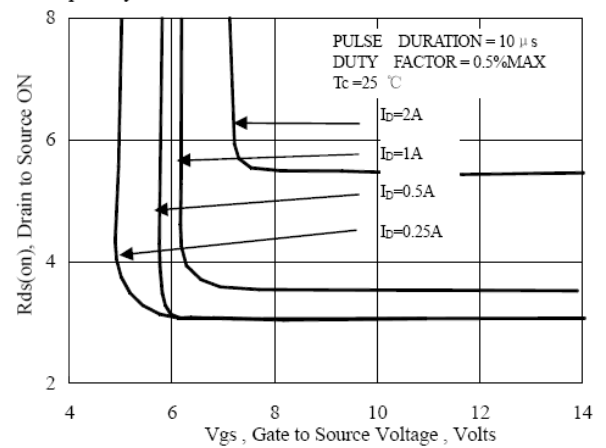

Figure 8 Typical Drain to Source ON Resistance vs Gate Voltage and Drain Current

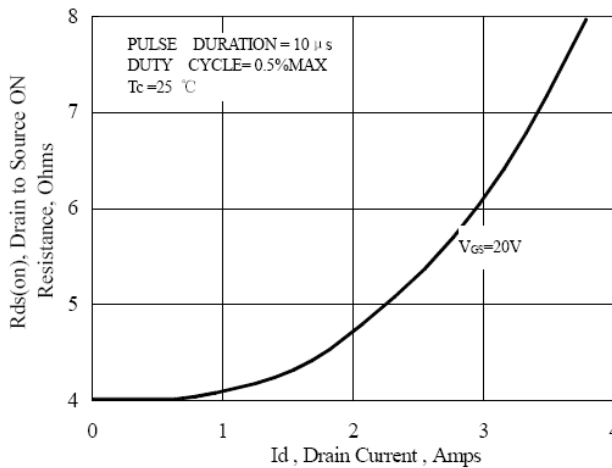

Figure 9 Typical Drain to Source ON Resistance vs Drain Current

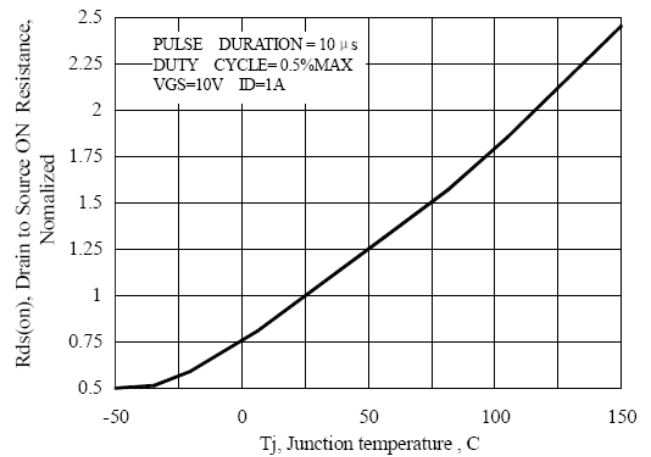

Figure 10 Typical Drain to Source on Resistance vs Junction Temperature



Silicon N-Channel Power MOSFET

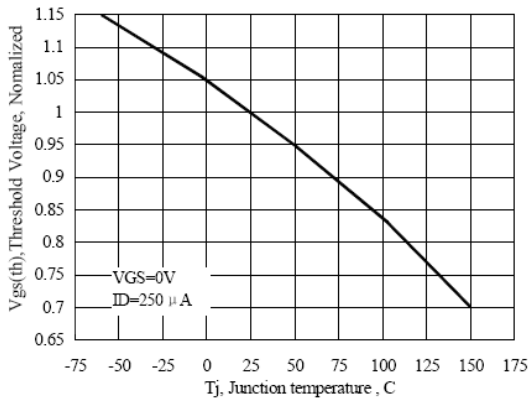

Figure 11 Typical Theshold Voltage vs Junction Temperature

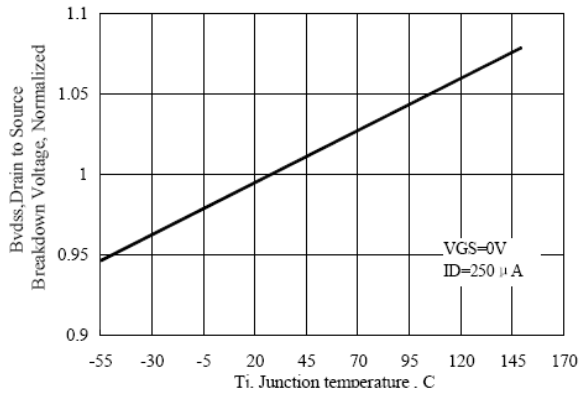

Figure 12 Typical Breakdown Voltage vs Junction Temperature

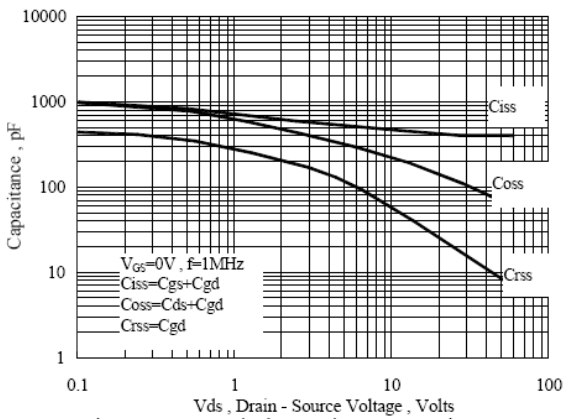

Figure 13 Typical Capacitance vs Drain to Source Voltage

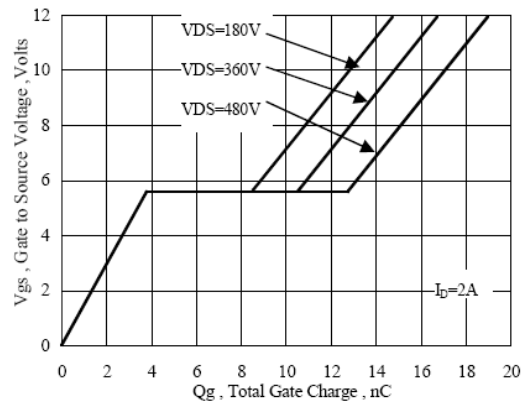

Figure 14 Typical Gate Charge vs Gate to Source Voltage

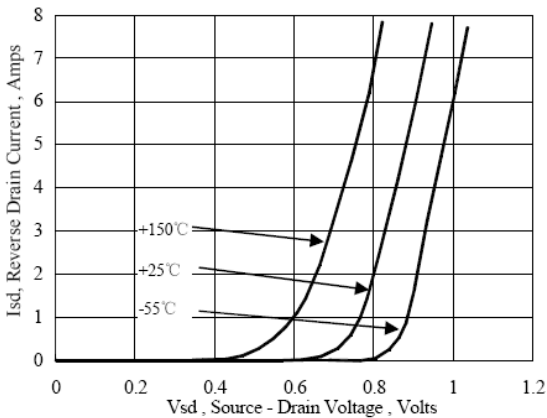

Figure 15 Typical Body Diode Transfer Characteristics

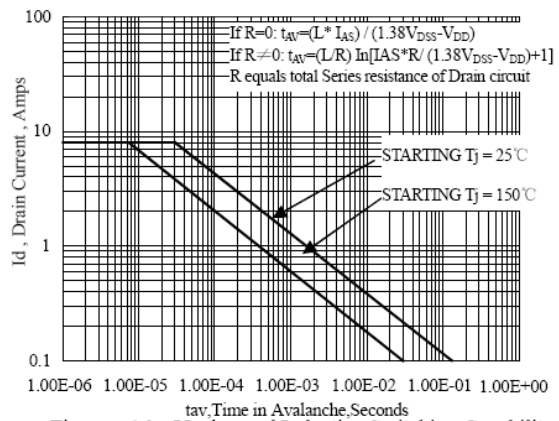

Figure 16 Unclamped Inductive Switching Capability

X-ON Electronics

Largest Supplier of Electrical and Electronic Components

Click to view similar products for [MOSFET](#) category:

Click to view products by [Weida Semiconductor](#) manufacturer:

Other Similar products are found below :

[IRFD120](#) [JANTX2N5237](#) [2SK2267\(Q\)](#) [BUK455-60A/B](#) [TK100A10N1,S4X\(S](#) [MIC4420CM-TR](#) [VN1206L](#) [NDP4060](#) [SI4482DY](#)
[IRS2092STRPBF-EL](#) [IPS70R2K0CEAKMA1](#) [TK31J60W5,S1VQ\(O](#) [TK31J60W,S1VQ\(O](#) [TK16J60W,S1VQ\(O](#) [2SK2614\(TE16L1,Q\)](#)
[DMN1017UCP3-7](#) [EFC2J004NUZTDG](#) [P85W28HP2F-7071](#) [DMN1053UCP4-7](#) [NTE2384](#) [DMC2700UDMQ-7](#) [DMN2080UCB4-7](#)
[DMN61D9UWQ-13](#) [US6M2GTR](#) [DMN31D5UDJ-7](#) [DMP22D4UFO-7B](#) [IPS60R3K4CEAKMA1](#) [DMN1006UCA6-7](#) [DMN16M9UCA6-7](#)
[STF5N65M6](#) [IRF40H233XTMA1](#) [STU5N65M6](#) [DMN6022SSD-13](#) [DMN13M9UCA6-7](#) [DMTH10H4M6SPS-13](#) [IPS60R360PFD7SAKMA1](#)
[DMN2990UFB-7B](#) [SSM3K35CT,L3F](#) [IPLK60R1K0PFD7ATMA1](#) [2N7002W-G](#) [MCAC30N06Y-TP](#) [IPWS65R035CFD7AXKSA1](#)
[MCQ7328-TP](#) [SSM3J143TU,LXHF](#) [DMN12M3UCA6-7](#) [PJMF280N65E1_T0_00201](#) [PJMF380N65E1_T0_00201](#)
[PJMF280N60E1_T0_00201](#) [PJMF600N65E1_T0_00201](#) [PJMF900N65E1_T0_00201](#)