

## BLF 5.08HC/04/180 SN OR BX

**Weidmüller Interface GmbH & Co. KG**  
 Klingenbergstraße 26  
 D-32758 Detmold  
 Germany

www.weidmueller.com

### Product image

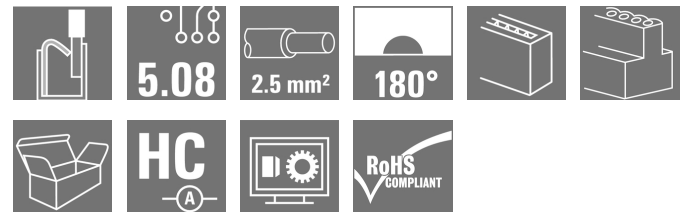
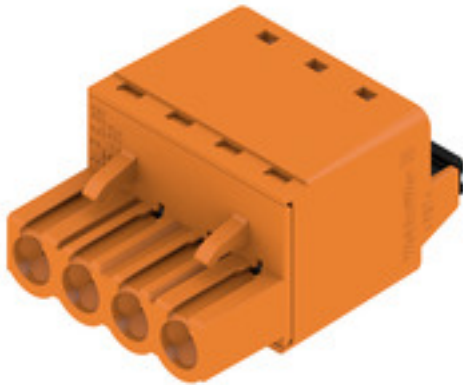

Just as reliable as the millionfold proven original and featuring innovative details:

The BLF 5.08HC PUSH IN version of the BLZP 5.08HC female connector is not only different in terms of connection system; it also has a more compact design. Weidmüller's innovative PUSH IN spring connection system stands for the future of easy and tool-free wire connection. HC = High Current.

In terms of versatility, the BLF 5.08HC offers just as much as the version which served as a model:

- 3 tested-and-proven wire outlet directions provide the usual flexibility for application-specific design
- 4 flange variations and the patented release latch allow the locking concept to be based on the requirements of the user
- Use the BLF 5.08HC and SL 5.08HC plug combination to reach the max. rated specifications

### General ordering data

Version	PCB plug-in connector, female plug, 5.08 mm, Number of poles: 4, 180°, PUSH IN with actuator, Tension-clamp connection, Clamping range, max. : 3.31 mm², Box
Order No.	<a href="#">1013710000</a>
Type	BLF 5.08HC/04/180 SN OR BX
GTIN (EAN)	4032248721825
Qty.	90 pc(s).
Product data	IEC: 400 V / 24 A / 0.2 - 2.5 mm² UL: 300 V / 18.5 A / AWG 26 - AWG 12
Packaging	Box

## BLF 5.08HC/04/180 SN OR BX

Weidmüller Interface GmbH &amp; Co. KG

Klingenbergstraße 26

D-32758 Detmold

Germany

www.weidmueller.com

## Technical data

## Dimensions and weights

Depth	27.7 mm	Depth (inches)	1.091 inch
Height	14.2 mm	Height (inches)	0.559 inch
Width	20.32 mm	Width (inches)	0.8 inch
Net weight	7.967 g		

## System Parameters

Product family	OMNIMATE Signal - series BL/SL 5.08	Type of connection	Field connection
Wire connection method	PUSH IN with actuator, Tension-clamp connection	Pitch in mm (P)	5.08 mm
Pitch in inches (P)	0.2 inch	Conductor outlet direction	180°
Number of poles	4	L1 in mm	15.24 mm
L1 in inches	0.6 inch	Number of rows	1
Pin series quantity	1	Rated cross-section	2.5 mm <sup>2</sup>
Touch-safe protection acc. to DIN VDE 57 106	Safe from finger touch	Touch-safe protection acc. to DIN VDE 0470	IP 20
Protection degree	IP20	Volume resistance	≤5 mΩ
Can be coded	Yes	Stripping length	10 mm
Screwdriver blade	0.6 x 3.5	Screwdriver blade standard	DIN 5264
Plugging cycles	25	Plugging force/pole, max.	7 N
Pulling force/pole, max.	5.5 N		

## Material data

Insulating material	PBT	Colour	orange
Colour chart (similar)	RAL 2000	Insulating material group	IIIa
Comparative Tracking Index (CTI)	≥ 200	UL 94 flammability rating	V-0
Contact material	CuSn	Contact surface	tinned
Layer structure of plug contact	4...8 μm Sn hot-dip tinned	Storage temperature, min.	-40 °C
Storage temperature, max.	70 °C	Operating temperature, min.	-50 °C
Operating temperature, max.	100 °C	Temperature range, installation, min.	-30 °C
Temperature range, installation, max.	100 °C		

## Conductors suitable for connection

Clamping range, min.	0.13 mm <sup>2</sup>
Clamping range, max.	3.31 mm <sup>2</sup>
Wire connection cross section AWG, min.	AWG 26
Wire connection cross section AWG, max.	AWG 12
Solid, min. H05(07) V-U	0.2 mm <sup>2</sup>
Solid, max. H05(07) V-U	2.5 mm <sup>2</sup>
Flexible, min. H05(07) V-K	0.2 mm <sup>2</sup>
Flexible, max. H05(07) V-K	2.5 mm <sup>2</sup>
w. plastic collar ferrule, DIN 46228 pt 4, min.	0.25 mm <sup>2</sup>
w. plastic collar ferrule, DIN 46228 pt 4, max.	2.5 mm <sup>2</sup>
w. wire end ferrule, DIN 46228 pt 1, min.	0.25 mm <sup>2</sup>
w. wire end ferrule, DIN 46228 pt 1, max.	2.5 mm <sup>2</sup>
Plug gauge in accordance with EN 60999 a x b; ø	2.8 mm x 2.0 mm

Creation date January 8, 2022 11:36:33 PM CET

## BLF 5.08HC/04/180 SN OR BX

Weidmüller Interface GmbH &amp; Co. KG

Klingenbergstraße 26

D-32758 Detmold

Germany

www.weidmueller.com

## Technical data

Clampable conductor	Cross-section for conductor connection	Type	fine-wired
		nominal	0.5 mm <sup>2</sup>
wire end ferrule		Stripping length	nominal 12 mm
		Recommended wire-end ferrule	<a href="#">H0.5/16 OR</a>
		Stripping length	nominal 10 mm
		Recommended wire-end ferrule	<a href="#">H0.5/10</a>
Cross-section for conductor connection	Type	fine-wired	
	nominal	0.75 mm <sup>2</sup>	
wire end ferrule		Stripping length	nominal 12 mm
		Recommended wire-end ferrule	<a href="#">H0.75/16 W</a>
		Stripping length	nominal 10 mm
		Recommended wire-end ferrule	<a href="#">H0.75/10</a>
Cross-section for conductor connection	Type	fine-wired	
	nominal	1 mm <sup>2</sup>	
wire end ferrule		Stripping length	nominal 12 mm
		Recommended wire-end ferrule	<a href="#">H1.0/16D R</a>
		Stripping length	nominal 10 mm
		Recommended wire-end ferrule	<a href="#">H1.0/10</a>
Cross-section for conductor connection	Type	fine-wired	
	nominal	1.5 mm <sup>2</sup>	
wire end ferrule		Stripping length	nominal 10 mm
		Recommended wire-end ferrule	<a href="#">H1.5/10</a>
		Stripping length	nominal 12 mm
		Recommended wire-end ferrule	<a href="#">H1.5/16 R</a>
Cross-section for conductor connection	Type	fine-wired	
	nominal	2.5 mm <sup>2</sup>	
wire end ferrule		Stripping length	nominal 10 mm
		Recommended wire-end ferrule	<a href="#">H2.5/10</a>
		Stripping length	nominal 10 mm
		Recommended wire-end ferrule	<a href="#">H2.5/14DS BL</a>

Reference text The outside diameter of the plastic collar should not be larger than the pitch (P), Length of ferrules is to be chosen depending on the product and the rated voltage.

## Rated data acc. to IEC

tested acc. to standard	IEC 60664-1, IEC 61984	Rated current, min. number of poles (Tu=20°C)	24 A
Rated current, max. number of poles (Tu=20°C)	19 A	Rated current, min. number of poles (Tu=40°C)	21 A
Rated current, max. number of poles (Tu=40°C)	16.5 A	Rated voltage for surge voltage class / pollution degree II/2	400 V
Rated voltage for surge voltage class / pollution degree III/2	320 V	Rated voltage for surge voltage class / pollution degree III/3	250 V
Rated impulse voltage for surge voltage class/ pollution degree II/2	4 kV	Rated impulse voltage for surge voltage class/ pollution degree III/2	4 kV
Rated impulse voltage for surge voltage class/ contamination degree III/3	4 kV	Short-time withstand current resistance	3 x 1s with 120 A

## BLF 5.08HC/04/180 SN OR BX

**Weidmüller Interface GmbH & Co. KG**  
 Klingenbergstraße 26  
 D-32758 Detmold  
 Germany

www.weidmueller.com

## Technical data

### Rated data acc. to CSA

Institute (CSA)		Certificate No. (CSA)	
			
		200039-1121690	
Rated voltage (Use group B / CSA)	300 V	Rated voltage (Use group D / CSA)	300 V
Rated current (Use group D / CSA)	10 A	Wire cross-section, AWG, min.	AWG 26
Wire cross-section, AWG, max.		Reference to approval values	Specifications are maximum values, details - see approval certificate.
	AWG 12		

### Rated data acc. to UL 1059

Institute (cURus)		Certificate No. (cURus)	
			
		E60693	
Rated voltage (Use group B / UL 1059)	300 V	Rated voltage (Use group D / UL 1059)	300 V
Rated current (Use group B / UL 1059)	18.5 A	Rated current (Use group D / UL 1059)	10 A
Wire cross-section, AWG, min.	AWG 26	Wire cross-section, AWG, max.	AWG 12
Reference to approval values	Specifications are maximum values, details - see approval certificate.		

### Packing

Packaging	Box	VPE length	352 mm
VPE width	136 mm	VPE height	38 mm

### Type tests

Test: Durability of markings	Standard	DIN EN 61984 section 7.3.2 / 09.02 taking pattern from DIN EN 60068-2-70 / 07.96
	Test	mark of origin, type identification, pitch, type of material, date clock
	Evaluation	available
	Test	durability
	Evaluation	passed
Test: Misengagement (Non-interchangeability)	Standard	DIN EN 61984 section 6.3 and 6.9.1 / 09.02, DIN EN 60512-13-5 / 11.08
	Test	180° turned with coding elements
	Evaluation	passed
	Test	visual examination
	Evaluation	passed

**BLF 5.08HC/04/180 SN OR BX**

**Weidmüller Interface GmbH & Co. KG**  
 Klingenbergstraße 26  
 D-32758 Detmold  
 Germany

www.weidmueller.com

**Technical data**

Test: Clampable cross section	Standard	DIN EN 60999-1 section 7 and 9.1 / 12.00, DIN EN 60947-1 section 8.2.4.5.1 / 04.08	
	Conductor type	Type of conductor and conductor cross-section	solid 0.2 mm <sup>2</sup>
		Type of conductor and conductor cross-section	stranded 0.2 mm <sup>2</sup>
		Type of conductor and conductor cross-section	solid 2.5 mm <sup>2</sup>
		Type of conductor and conductor cross-section	stranded 2.5 mm <sup>2</sup>
		Type of conductor and conductor cross-section	AWG 26/1
		Type of conductor and conductor cross-section	AWG 26/19
		Type of conductor and conductor cross-section	AWG 14/1
		Type of conductor and conductor cross-section	AWG 14/19
Evaluation	passed		
Test for damage to and accidental loosening of conductors	Standard	DIN EN 60999-1 section 9.4 / 12.00	
	Requirement	0.2 kg	
	Conductor type	Type of conductor and conductor cross-section	AWG 26/1
		Type of conductor and conductor cross-section	AWG 26/19
	Evaluation	passed	
	Requirement	0.3 kg	
	Conductor type	Type of conductor and conductor cross-section	H05V-U0.5
		Type of conductor and conductor cross-section	H05V-K0.5
	Evaluation	passed	
	Requirement	0.7 kg	
	Conductor type	Type of conductor and conductor cross-section	H07V-U2.5
		Type of conductor and conductor cross-section	H07V-K2.5
	Evaluation	passed	
	Requirement	0.9 kg	
	Conductor type	Type of conductor and conductor cross-section	AWG 12/1
Type of conductor and conductor cross-section		AWG 12/19	
Evaluation	passed		

**BLF 5.08HC/04/180 SN OR BX**

**Weidmüller Interface GmbH & Co. KG**  
 Klingenbergstraße 26  
 D-32758 Detmold  
 Germany

www.weidmueller.com

**Technical data**

Pull-out test	Standard	DIN EN 60999-1 section 9.5 / 12.00		
	Requirement	≥10 N		
	Conductor type	Type of conductor and conductor cross-section	AWG 26/1	
		Type of conductor and conductor cross-section	AWG 26/19	
	Evaluation	passed		
	Requirement	≥20 N		
	Conductor type	Type of conductor and conductor cross-section	H05V-K0.5	
		Type of conductor and conductor cross-section	H05V-U0.5	
	Evaluation	passed		
	Requirement	≥50 N		
	Conductor type	Type of conductor and conductor cross-section	H07V-U2.5	
		Type of conductor and conductor cross-section	H07V-K2.5	
	Evaluation	passed		
	Requirement	≥60 N		
	Conductor type	Type of conductor and conductor cross-section	AWG 12/1	
		Type of conductor and conductor cross-section	AWG 12/19	
	Evaluation	passed		

**Classifications**

ETIM 6.0	EC002638	ETIM 7.0	EC002638
ETIM 8.0	EC002638	ECLASS 9.0	27-44-03-09
ECLASS 9.1	27-44-03-09	ECLASS 10.0	27-44-03-09
ECLASS 11.0	27-46-02-02		

**BLF 5.08HC/04/180 SN OR BX**

**Weidmüller Interface GmbH & Co. KG**  
 Klingenbergstraße 26  
 D-32758 Detmold  
 Germany

www.weidmueller.com

**Technical data****Important note**

IPC conformity	Conformity: The products are developed, manufactured and delivered according international recognized standards and norms and comply with the assured properties in the data sheet resp. fulfill decorative properties in accordance with IPC-A-610 "Class 2". Further claims on the products can be evaluated on request.
Notes	<ul style="list-style-type: none"> <li>• Additional colours on request</li> <li>• Gold-plated contact surfaces on request</li> <li>• Rated current related to rated cross-section &amp; min. No. of poles.</li> <li>• Wire end ferrule without plastic collar to DIN 46228/1</li> <li>• Wire end ferrule with plastic collar to DIN 46228/4</li> <li>• P on drawing = pitch</li> <li>• Crimping shape "A" for wire end ferrules with PZ 6/5 crimping tool recommended.</li> <li>• The test point can only be used as potential-pickup point.</li> <li>• Long term storage of the product with average temperature of 50 °C and average humidity 70%, 36 months</li> </ul>

**Approvals**

Approvals



ROHS	Conform
UL File Number Search	E60693

**Downloads**

Approval/Certificate/Document of Conformity	<a href="#">Declaration of the Manufacturer</a>
Engineering Data	<a href="#">CAD data – STEP</a>
Engineering Data	<a href="#">EPLAN, WSCAD, Zuken E3.S</a>
Catalogues	<a href="#">Catalogues in PDF-format</a>
Brochures	<a href="#">FL DRIVES EN</a> <a href="#">MB DEVICE MANUF. EN</a> <a href="#">FL DRIVES DE</a> <a href="#">FL BUILDING SAFETY EN</a> <a href="#">FL APPL LED LIGHTING EN</a> <a href="#">FLIndustr.CONTROLS EN</a> <a href="#">FL MACHINE SAFETY EN</a> <a href="#">FL HEATING ELECTR EN</a> <a href="#">FL APPL INVERTER EN</a> <a href="#">FL_BASE_STATION_EN</a> <a href="#">FL ELEVATOR EN</a> <a href="#">FL POWER SUPPLY EN</a> <a href="#">FL 72H SAMPLE SER EN</a> <a href="#">PO OMNIMATE EN</a> <a href="#">PO OMNIMATE EN</a>

**BLF 5.08HC/04/180 SN OR BX**

**Weidmüller Interface GmbH & Co. KG**  
 Klingenbergstraße 26  
 D-32758 Detmold  
 Germany

www.weidmueller.com

**Drawings**

**Product image**

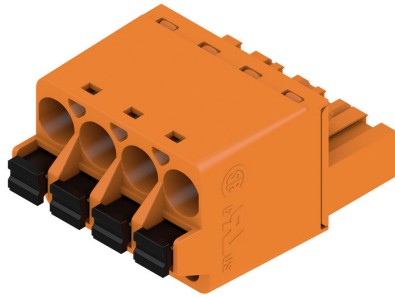

**Dimensional drawing**

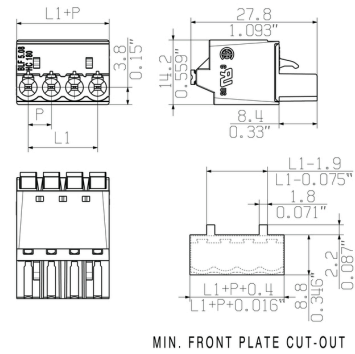

**Graph**



**Graph**



Uncompromising functionality  
 High vibration resistance



## BLF 5.08HC/04/180 SN OR BX

**Weidmüller Interface GmbH & Co. KG**  
 Klingenbergstraße 26  
 D-32758 Detmold  
 Germany

www.weidmueller.com

# Accessories

## Slotted screwdriver

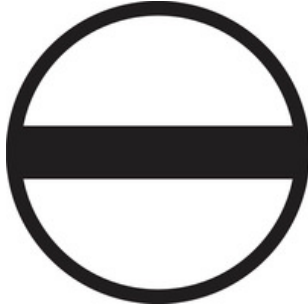

Slotted screwdriver with rounded blade SD DIN 5265, ISO 2380/2, output to DIN 5264, ISO 2380/1. ChromTop tip, SoftFinish grip

### General ordering data

Type	SDS 0.6X3.5X200	Version	
Order No.	<a href="#">9010110000</a>	Screwdriver, Screwdriver	
GTIN (EAN)	4032248300754		
Qty.	1 pc(s).		
Type	SDS 0.6X3.5X100	Version	
Order No.	<a href="#">2749340000</a>	Screwdriver, Blade width (B): 3.5 mm, Blade length: 100 mm, Blade thickness (A): 0.6 mm	
GTIN (EAN)	4050118895568		
Qty.	1 pc(s).		

## Coding elements



**Only connects what is supposed to be connected: the right connection at the right place.**

Coding elements and locking devices clearly assign connecting elements during the manufacturing process and operation

The coding elements and locking devices are inserted prior to assembly or during the cable assembly phase. The Weidmüller alternative: configure online using the variant configurator to precode prior to delivery.

Incorrect assembly on the circuit board and incorrect plugging of connecting elements is no longer possible. The advantage: no troubleshooting during manufacture and no operational errors by the user.

### General ordering data

Type	BLZ/SL KO OR BX	Version	Product data	Packaging
Order No.	<a href="#">1573010000</a>	PCB plug-in connector, Accessories, Coding element, orange, Number		Box
GTIN (EAN)	4008190048396	of poles: 1		
Qty.	100 pc(s).			
Type	BLZ/SL KO BK BX	Version	Product data	Packaging
Order No.	<a href="#">1545710000</a>	PCB plug-in connector, Accessories, Coding element, black, Number		Box
GTIN (EAN)	4008190087142	of poles: 1		
Qty.	50 pc(s).			

**Data sheet**

**BLF 5.08HC/04/180 SN OR BX**

**Weidmüller Interface GmbH & Co. KG**  
 Klingenbergstraße 26  
 D-32758 Detmold  
 Germany

www.weidmueller.com

**Accessories**

**Slotted screwdriver**



VDE insulated slot-head screwdriver, SDI DIN 7437, ISO 2380/2, drive output acc. to DIN 5264, ISO 2380/1. SoftFinish grip

**General ordering data**

Type	SDIS 0.6X3.5X100	Version
Order No.	<a href="#">2749810000</a>	Screwdriver, Blade width (B): 3.5 mm, Blade length: 100 mm, Blade thickness (A): 0.6 mm
GTIN (EAN)	4050118897012	
Qty.	1 pc(s).	

**BLF 5.08HC/04/180 SN OR BX**

**Weidmüller Interface GmbH & Co. KG**  
Klingenbergstraße 26  
D-32758 Detmold  
Germany

[www.weidmueller.com](http://www.weidmueller.com)

Drawings

**Product benefits**

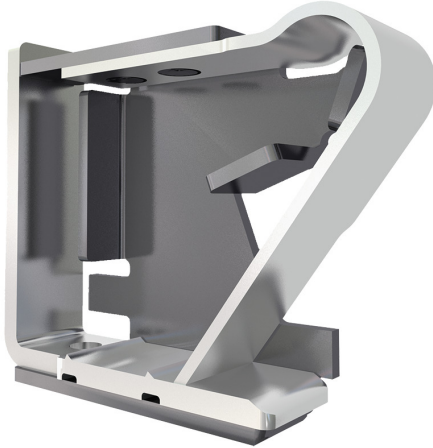

Solid PUSH IN contact  
Safe and durable

**Product benefits**

**Product benefits**

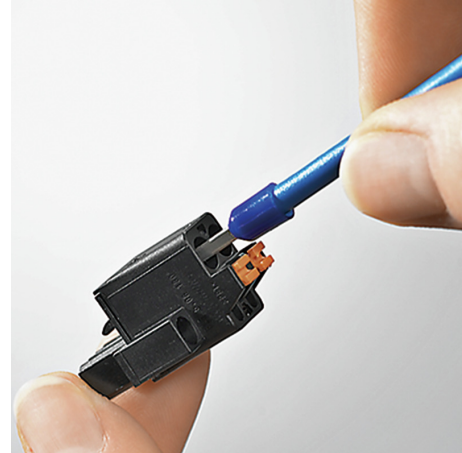

Cost-effective wiring  
Quick and intuitive operation

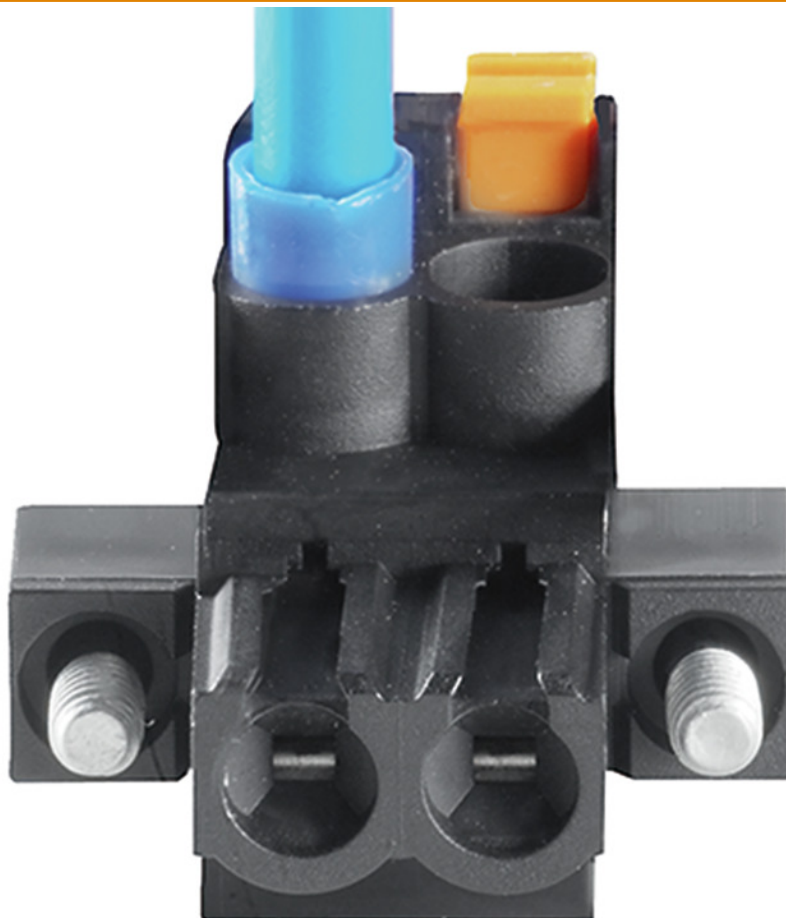

Wide clamping range  
Tool-free wire connection

The reproduction, distribution and utilization of this document as well as the communication of its contents to others without explicit authorization is prohibited. Offenders will be held liable for the payment of damages. Weidmueller exclusively reserves the right to file for patents, utility models or designs.

© Weidmueller Interface GmbH & Co. KG

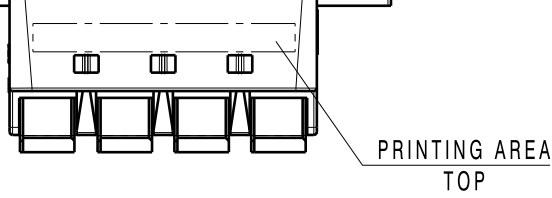

L1+0.609  
FRONT PLATE CUT-OUT

M 1/1

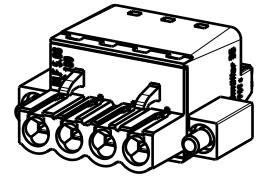

SHOWN: BLF 5.08HC/04/180LR

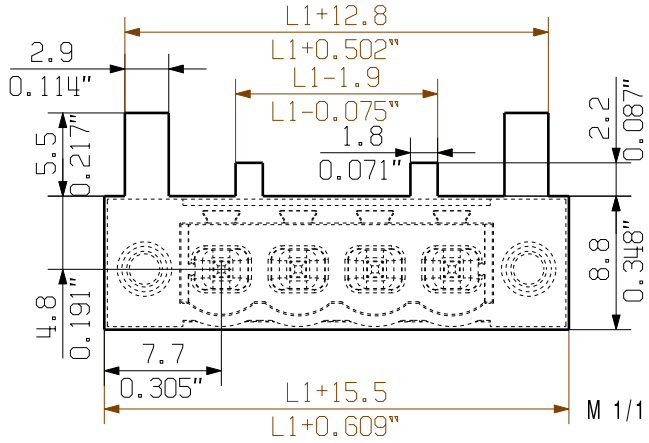
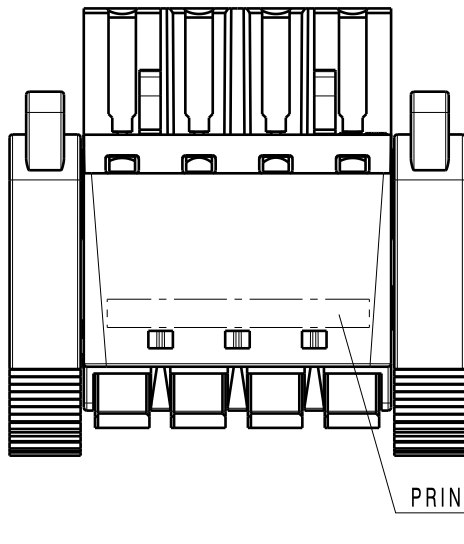
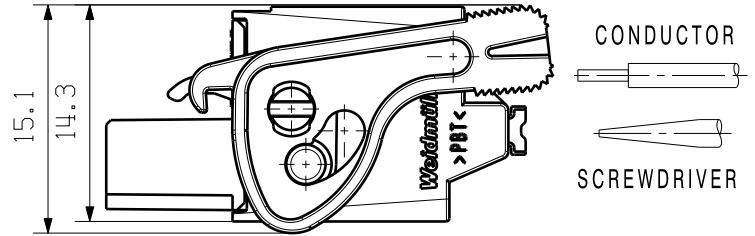
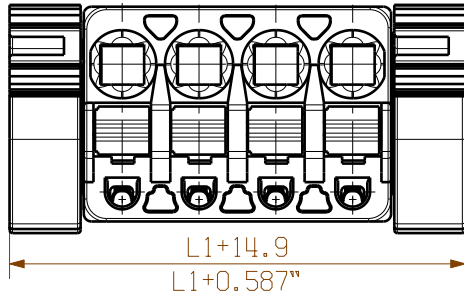

FRONT PLATE CUT-OUT

M 1/1

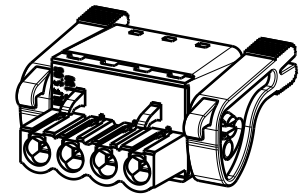

SHOWN: BLF 5.08HC/04/180G SO

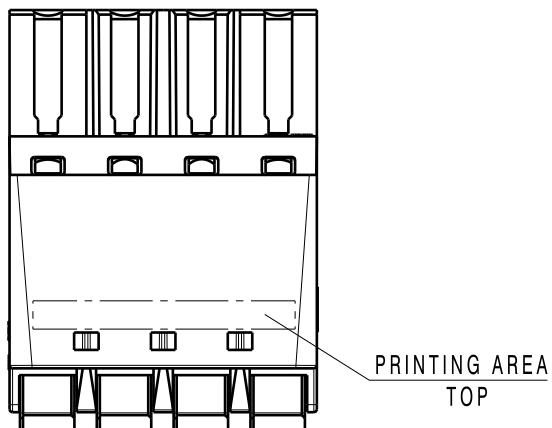
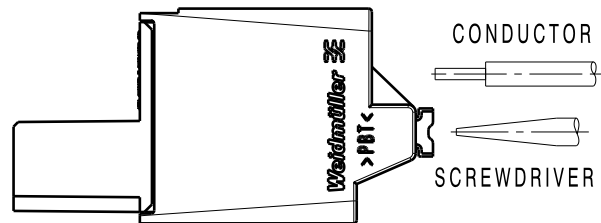
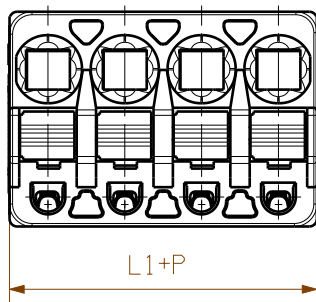

M 1/1

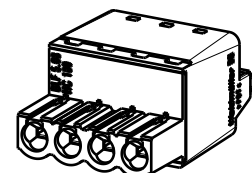

## X-ON Electronics

Largest Supplier of Electrical and Electronic Components

*Click to view similar products for [Pluggable Terminal Blocks](#) category:*

*Click to view products by [Weidmuller](#) manufacturer:*

Other Similar products are found below :

[57.510.0053](#) [MC 1.5/ 6-ST-3.5 GY AU](#) [ET02015000J0G](#) [734-104](#) [734-302](#) [8-141-P](#) [8426620000](#) [860505](#) [860516](#) [860810](#) [GBPACX-12](#)  
[PV05-5,08-K](#) [PVP02-5,00](#) [PVP03-3,50](#) [PVP04-3,50](#) [PVS02-5,00](#) [1-1986160-3](#) [1377680000](#) [1531000000](#) [1546228-5](#) [ELFH16150](#)  
[ELFP03110](#) [ELFP10210](#) [ELFT06250](#) [ELVP03100](#) [1700101](#) [1700410](#) [1700425](#) [1702246](#) [1705229](#) [1710175](#) [1714537](#) [1717806](#) [1719600](#)  
[1728941](#) [1734692](#) [1734795](#) [1736036](#) [1740194](#) [1740628](#) [1740990](#) [1746952](#) [1750207](#) [1752441](#) [1752865](#) [1754115](#) [1754144](#) [1756913](#)  
[1760051](#) [1760336](#)