

BLF 5.08HC/09/180 SN OR BX

Weidmüller Interface GmbH & Co. KG
Klingenbergstraße 26
D-32758 Detmold
Germany

www.weidmueller.com

Product image

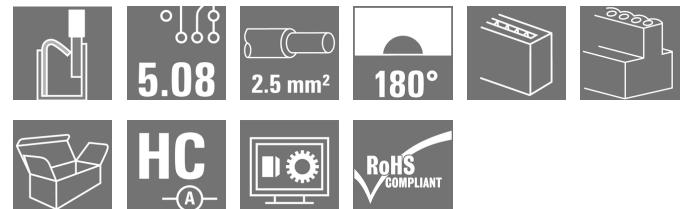

Just as reliable as the millionfold proven original and featuring innovative details:

The BLF 5.08HC PUSH IN version of the BLZP 5.08HC female connector is not only different in terms of connection system; it also has a more compact design. Weidmüller's innovative PUSH IN spring connection system stands for the future of easy and tool-free wire connection. HC = High Current.

In terms of versatility, the BLF 5.08HC offers just as much as the version which served as a model:

- 3 tested-and-proven wire outlet directions provide the usual flexibility for application-specific design
- 4 flange variations and the patented release latch allow the locking concept to be based on the requirements of the user
- Use the BLF 5.08HC and SL 5.08HC plug combination to reach the max. rated specifications

General ordering data

| | |
|--------------|---|
| Version | PCB plug-in connector, female plug, 5.08 mm, Number of poles: 9, 180°, PUSH IN with actuator, Tension-clamp connection, Clamping range, max. : 3.31 mm ² , Box |
| Order No. | 1013760000 |
| Type | BLF 5.08HC/09/180 SN OR BX |
| GTIN (EAN) | 4032248721870 |
| Qty. | 36 pc(s). |
| Product data | IEC: 400 V / 24 A / 0.2 - 2.5 mm ² UL: 300 V / 18.5 A / AWG 26 - AWG 12 |
| Packaging | Box |

BLF 5.08HC/09/180 SN OR BX
Weidmüller Interface GmbH & Co. KG

 Klingenbergstraße 26
 D-32758 Detmold
 Germany

www.weidmueller.com
Technical data
Dimensions and weights

| | | | |
|------------|----------|-----------------|------------|
| Depth | 27.7 mm | Depth (inches) | 1.091 inch |
| Height | 14.2 mm | Height (inches) | 0.559 inch |
| Width | 45.72 mm | Width (inches) | 1.8 inch |
| Net weight | 17.972 g | | |

System Parameters

| | | | |
|--|---|--|---------------------|
| Product family | OMNIMATE Signal - series BL/SL 5.08 | Type of connection | Field connection |
| Wire connection method | PUSH IN with actuator, Tension-clamp connection | Pitch in mm (P) | 5.08 mm |
| Pitch in inches (P) | 0.2 inch | Conductor outlet direction | 180° |
| Number of poles | 9 | L1 in mm | 40.64 mm |
| L1 in inches | 1.6 inch | Number of rows | 1 |
| Pin series quantity | 1 | Rated cross-section | 2.5 mm ² |
| Touch-safe protection acc. to DIN VDE 57 106 | Safe from finger touch | Touch-safe protection acc. to DIN VDE 0470 | IP 20 |
| Protection degree | IP20 | Volume resistance | ≤5 mΩ |
| Can be coded | Yes | Stripping length | 10 mm |
| Screwdriver blade | 0.6 x 3.5 | Screwdriver blade standard | DIN 5264 |
| Plugging cycles | 25 | Plugging force/pole, max. | 7 N |
| Pulling force/pole, max. | 5.5 N | | |

Material data

| | | | |
|---------------------------------------|----------------------------|---------------------------------------|--------|
| Insulating material | PBT | Colour | orange |
| Colour chart (similar) | RAL 2000 | Insulating material group | IIIa |
| Comparative Tracking Index (CTI) | ≥ 200 | UL 94 flammability rating | V-0 |
| Contact material | CuSn | Contact surface | tinned |
| Layer structure of plug contact | 4...8 μm Sn hot-dip tinned | Storage temperature, min. | -40 °C |
| Storage temperature, max. | 70 °C | Operating temperature, min. | -50 °C |
| Operating temperature, max. | 100 °C | Temperature range, installation, min. | -30 °C |
| Temperature range, installation, max. | 100 °C | | |

Conductors suitable for connection

| | |
|---|----------------------|
| Clamping range, min. | 0.13 mm ² |
| Clamping range, max. | 3.31 mm ² |
| Wire connection cross section AWG, min. | AWG 26 |
| Wire connection cross section AWG, max. | AWG 12 |
| Solid, min. H05(07) V-U | 0.2 mm ² |
| Solid, max. H05(07) V-U | 2.5 mm ² |
| Flexible, min. H05(07) V-K | 0.2 mm ² |
| Flexible, max. H05(07) V-K | 2.5 mm ² |
| w. plastic collar ferrule, DIN 46228 pt 4, min. | 0.25 mm ² |
| w. plastic collar ferrule, DIN 46228 pt 4, max. | 2.5 mm ² |
| w. wire end ferrule, DIN 46228 pt 1, min. | 0.25 mm ² |
| w. wire end ferrule, DIN 46228 pt 1, max. | 2.5 mm ² |
| Plug gauge in accordance with EN 60999 a x b; ø | 2.8 mm x 2.0 mm |

Creation date January 18, 2022 8:09:20 AM CET

BLF 5.08HC/09/180 SN OR BX

Weidmüller Interface GmbH & Co. KG

Klingenbergstraße 26

D-32758 Detmold

Germany

www.weidmueller.com

Technical data

| | | | |
|--|--|------------------------------|------------------------------|
| Clampable conductor | Cross-section for conductor connection | Type | fine-wired |
| | | nominal | 0.5 mm ² |
| wire end ferrule | | Stripping length | nominal 12 mm |
| | | Recommended wire-end ferrule | H0.5/16 OR |
| | | Stripping length | nominal 10 mm |
| | | Recommended wire-end ferrule | H0.5/10 |
| Cross-section for conductor connection | Type | fine-wired | |
| | nominal | 0.75 mm ² | |
| wire end ferrule | | Stripping length | nominal 12 mm |
| | | Recommended wire-end ferrule | H0.75/16 W |
| | | Stripping length | nominal 10 mm |
| | | Recommended wire-end ferrule | H0.75/10 |
| Cross-section for conductor connection | Type | fine-wired | |
| | nominal | 1 mm ² | |
| wire end ferrule | | Stripping length | nominal 12 mm |
| | | Recommended wire-end ferrule | H1.0/16D R |
| | | Stripping length | nominal 10 mm |
| | | Recommended wire-end ferrule | H1.0/10 |
| Cross-section for conductor connection | Type | fine-wired | |
| | nominal | 1.5 mm ² | |
| wire end ferrule | | Stripping length | nominal 10 mm |
| | | Recommended wire-end ferrule | H1.5/10 |
| | | Stripping length | nominal 12 mm |
| | | Recommended wire-end ferrule | H1.5/16 R |
| Cross-section for conductor connection | Type | fine-wired | |
| | nominal | 2.5 mm ² | |
| wire end ferrule | | Stripping length | nominal 10 mm |
| | | Recommended wire-end ferrule | H2.5/10 |
| | | Stripping length | nominal 10 mm |
| | | Recommended wire-end ferrule | H2.5/14DS BL |

Reference text The outside diameter of the plastic collar should not be larger than the pitch (P), Length of ferrules is to be chosen depending on the product and the rated voltage.

Rated data acc. to IEC

| | | | |
|---|------------------------|---|-------------------|
| tested acc. to standard | IEC 60664-1, IEC 61984 | Rated current, min. number of poles (Tu=20°C) | 24 A |
| Rated current, max. number of poles (Tu=20°C) | 19 A | Rated current, min. number of poles (Tu=40°C) | 21 A |
| Rated current, max. number of poles (Tu=40°C) | 16.5 A | Rated voltage for surge voltage class / pollution degree II/2 | 400 V |
| Rated voltage for surge voltage class / pollution degree III/2 | 320 V | Rated voltage for surge voltage class / pollution degree III/3 | 250 V |
| Rated impulse voltage for surge voltage class/ pollution degree II/2 | 4 kV | Rated impulse voltage for surge voltage class/ pollution degree III/2 | 4 kV |
| Rated impulse voltage for surge voltage class/ contamination degree III/3 | 4 kV | Short-time withstand current resistance | 3 x 1s with 120 A |

BLF 5.08HC/09/180 SN OR BX

Weidmüller Interface GmbH & Co. KG
 Klingenbergstraße 26
 D-32758 Detmold
 Germany

www.weidmueller.com

Technical data

Rated data acc. to CSA

| | | | |
|---|--------|-----------------------------------|--|
| Institute (CSA) | | Certificate No. (CSA) | |
|  | | | |
| | | 200039-1121690 | |
| Rated voltage (Use group B / CSA) | 300 V | Rated voltage (Use group D / CSA) | 300 V |
| Rated current (Use group D / CSA) | 10 A | Wire cross-section, AWG, min. | AWG 26 |
| Wire cross-section, AWG, max. | AWG 12 | Reference to approval values | Specifications are maximum values, details - see approval certificate. |

Rated data acc. to UL 1059

| | | | |
|---|--|---------------------------------------|--------|
| Institute (cURus) | | Certificate No. (cURus) | |
|  | | | |
| | | E60693 | |
| Rated voltage (Use group B / UL 1059) | 300 V | Rated voltage (Use group D / UL 1059) | 300 V |
| Rated current (Use group B / UL 1059) | 18.5 A | Rated current (Use group D / UL 1059) | 10 A |
| Wire cross-section, AWG, min. | AWG 26 | Wire cross-section, AWG, max. | AWG 12 |
| Reference to approval values | Specifications are maximum values, details - see approval certificate. | | |

Packing

| | | | |
|-----------|--------|------------|--------|
| Packaging | Box | VPE length | 351 mm |
| VPE width | 135 mm | VPE height | 36 mm |

Type tests

| | | |
|--|------------|--|
| Test: Durability of markings | Standard | DIN EN 61984 section 7.3.2 / 09.02 taking pattern from DIN EN 60068-2-70 / 07.96 |
| | Test | mark of origin, type identification, pitch, type of material, date clock |
| | Evaluation | available |
| | Test | durability |
| | Evaluation | passed |
| Test: Misengagement (Non-interchangeability) | Standard | DIN EN 61984 section 6.3 and 6.9.1 / 09.02, DIN EN 60512-13-5 / 11.08 |
| | Test | 180° turned with coding elements |
| | Evaluation | passed |
| | Test | visual examination |
| | Evaluation | passed |

BLF 5.08HC/09/180 SN OR BX

Weidmüller Interface GmbH & Co. KG
 Klingenbergstraße 26
 D-32758 Detmold
 Germany

www.weidmueller.com

Technical data

| | | | |
|---|----------------|--|------------------------------|
| Test: Clampable cross section | Standard | DIN EN 60999-1 section 7 and 9.1 / 12.00, DIN EN 60947-1 section 8.2.4.5.1 / 04.08 | |
| | Conductor type | Type of conductor and conductor cross-section | solid 0.2 mm ² |
| | | Type of conductor and conductor cross-section | stranded 0.2 mm ² |
| | | Type of conductor and conductor cross-section | solid 2.5 mm ² |
| | | Type of conductor and conductor cross-section | stranded 2.5 mm ² |
| | | Type of conductor and conductor cross-section | AWG 26/1 |
| | | Type of conductor and conductor cross-section | AWG 26/19 |
| | | Type of conductor and conductor cross-section | AWG 14/1 |
| | | Type of conductor and conductor cross-section | AWG 14/19 |
| Evaluation | passed | | |
| Test for damage to and accidental loosening of conductors | Standard | DIN EN 60999-1 section 9.4 / 12.00 | |
| | Requirement | 0.2 kg | |
| | Conductor type | Type of conductor and conductor cross-section | AWG 26/1 |
| | | Type of conductor and conductor cross-section | AWG 26/19 |
| | Evaluation | passed | |
| | Requirement | 0.3 kg | |
| | Conductor type | Type of conductor and conductor cross-section | H05V-U0.5 |
| | | Type of conductor and conductor cross-section | H05V-K0.5 |
| | Evaluation | passed | |
| | Requirement | 0.7 kg | |
| | Conductor type | Type of conductor and conductor cross-section | H07V-U2.5 |
| | | Type of conductor and conductor cross-section | H07V-K2.5 |
| | Evaluation | passed | |
| | Requirement | 0.9 kg | |
| | Conductor type | Type of conductor and conductor cross-section | AWG 12/1 |
| Type of conductor and conductor cross-section | | AWG 12/19 | |
| Evaluation | passed | | |

BLF 5.08HC/09/180 SN OR BX

Weidmüller Interface GmbH & Co. KG
 Klingenbergstraße 26
 D-32758 Detmold
 Germany

www.weidmueller.com

Technical data

| | | | | |
|---------------|----------------|---|-----------|--|
| Pull-out test | Standard | DIN EN 60999-1 section 9.5 / 12.00 | | |
| | Requirement | ≥10 N | | |
| | Conductor type | Type of conductor and conductor cross-section | AWG 26/1 | |
| | | Type of conductor and conductor cross-section | AWG 26/19 | |
| | Evaluation | passed | | |
| | Requirement | ≥20 N | | |
| | Conductor type | Type of conductor and conductor cross-section | H05V-K0.5 | |
| | | Type of conductor and conductor cross-section | H05V-U0.5 | |
| | Evaluation | passed | | |
| | Requirement | ≥50 N | | |
| | Conductor type | Type of conductor and conductor cross-section | H07V-U2.5 | |
| | | Type of conductor and conductor cross-section | H07V-K2.5 | |
| | Evaluation | passed | | |
| | Requirement | ≥60 N | | |
| | Conductor type | Type of conductor and conductor cross-section | AWG 12/1 | |
| | | Type of conductor and conductor cross-section | AWG 12/19 | |
| | Evaluation | passed | | |

Classifications

| | | | |
|-------------|-------------|-------------|-------------|
| ETIM 6.0 | EC002638 | ETIM 7.0 | EC002638 |
| ETIM 8.0 | EC002638 | ECLASS 9.0 | 27-44-03-09 |
| ECLASS 9.1 | 27-44-03-09 | ECLASS 10.0 | 27-44-03-09 |
| ECLASS 11.0 | 27-46-02-02 | | |

BLF 5.08HC/09/180 SN OR BX

Weidmüller Interface GmbH & Co. KG
 Klingenbergstraße 26
 D-32758 Detmold
 Germany

www.weidmueller.com

Technical data
Important note

| | |
|----------------|---|
| IPC conformity | Conformity: The products are developed, manufactured and delivered according international recognized standards and norms and comply with the assured properties in the data sheet resp. fulfill decorative properties in accordance with IPC-A-610 "Class 2". Further claims on the products can be evaluated on request. |
| Notes | <ul style="list-style-type: none"> • Additional colours on request • Gold-plated contact surfaces on request • Rated current related to rated cross-section & min. No. of poles. • Wire end ferrule without plastic collar to DIN 46228/1 • Wire end ferrule with plastic collar to DIN 46228/4 • P on drawing = pitch • Crimping shape "A" for wire end ferrules with PZ 6/5 crimping tool recommended. • The test point can only be used as potential-pickup point. |

Approvals

Approvals



| | |
|-----------------------|---------|
| ROHS | Conform |
| UL File Number Search | E60693 |

Downloads

| | |
|---|---|
| Approval/Certificate/Document of Conformity | Declaration of the Manufacturer |
| Engineering Data | CAD data – STEP |
| Engineering Data | EPLAN, WSCAD, Zuken E3.S |
| Catalogues | Catalogues in PDF-format |
| Brochures | FL DRIVES EN MB DEVICE MANUF. EN FL DRIVES DE FL BUILDING SAFETY EN FL APPL LED LIGHTING EN FLIndustr.CONTROLS EN FL MACHINE SAFETY EN FL HEATING ELECTR EN FL APPL INVERTER EN FL_BASE_STATION_EN FL ELEVATOR EN FL POWER SUPPLY EN FL 72H SAMPLE SER EN PO OMNIMATE EN PO OMNIMATE EN |

BLF 5.08HC/09/180 SN OR BX

Weidmüller Interface GmbH & Co. KG
 Klingenbergstraße 26
 D-32758 Detmold
 Germany

www.weidmueller.com

Drawings

Product image

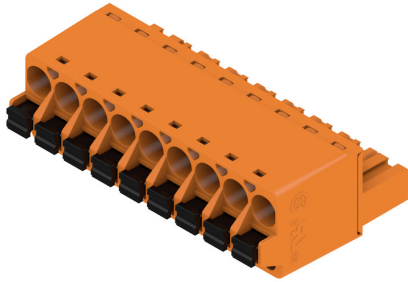

Dimensional drawing

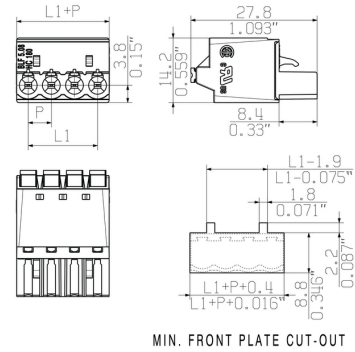

Graph

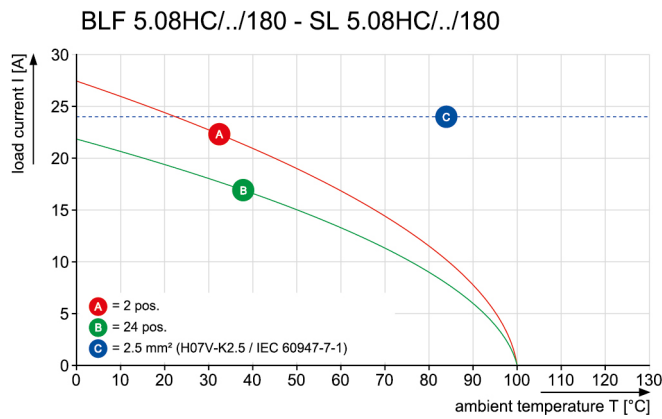

Graph

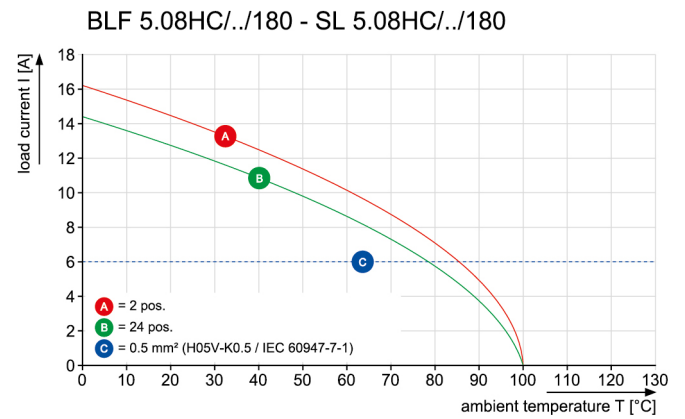

Uncompromising functionality
 High vibration resistance

BLF 5.08HC/09/180 SN OR BX

Weidmüller Interface GmbH & Co. KG
 Klingenbergstraße 26
 D-32758 Detmold
 Germany

www.weidmueller.com

Accessories
Slotted screwdriver

VDE insulated slot-head screwdriver, SDI DIN 7437, ISO 2380/2, drive output acc. to DIN 5264, ISO 2380/1. SoftFinish grip

General ordering data

| | | |
|------------|----------------------------|---|
| Type | SDIS 0.6X3.5X100 | Version |
| Order No. | 2749810000 | Screwdriver, Blade width (B): 3.5 mm, Blade length: 100 mm, Blade thickness (A): 0.6 mm |
| GTIN (EAN) | 4050118897012 | |
| Qty. | 1 pc(s). | |

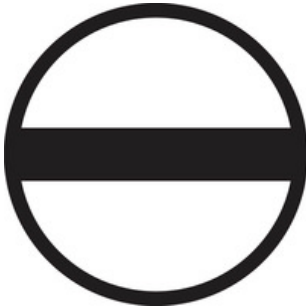
Slotted screwdriver

Slotted screwdriver with rounded blade SD DIN 5265, ISO 2380/2, output to DIN 5264, ISO 2380/1. ChromTop tip, SoftFinish grip

General ordering data

| | | |
|------------|----------------------------|---|
| Type | SDS 0.6X3.5X100 | Version |
| Order No. | 2749340000 | Screwdriver, Blade width (B): 3.5 mm, Blade length: 100 mm, Blade thickness (A): 0.6 mm |
| GTIN (EAN) | 4050118895568 | |
| Qty. | 1 pc(s). | |
| Type | SDS 0.6X3.5X200 | Version |
| Order No. | 9010110000 | Screwdriver, Screwdriver |
| GTIN (EAN) | 4032248300754 | |
| Qty. | 1 pc(s). | |

BLF 5.08HC/09/180 SN OR BX

Weidmüller Interface GmbH & Co. KG
 Klingenbergstraße 26
 D-32758 Detmold
 Germany

www.weidmueller.com

Accessories
Coding elements

Only connects what is supposed to be connected: the right connection at the right place.

Coding elements and locking devices clearly assign connecting elements during the manufacturing process and operation

The coding elements and locking devices are inserted prior to assembly or during the cable assembly phase. The Weidmüller alternative: configure online using the variant configurator to precode prior to delivery.

Incorrect assembly on the circuit board and incorrect plugging of connecting elements is no longer possible. The advantage: no troubleshooting during manufacture and no operational errors by the user.

General ordering data

| Type | BLZ/SL KO OR BX | Version | Product data | Packaging |
|------------|----------------------------|--|--------------|-----------|
| Order No. | 1573010000 | PCB plug-in connector, Accessories, Coding element, orange, Number | | Box |
| GTIN (EAN) | 4008190048396 | of poles: 1 | | |
| Qty. | 100 pc(s). | | | |
| Type | BLZ/SL KO BK BX | Version | Product data | Packaging |
| Order No. | 1545710000 | PCB plug-in connector, Accessories, Coding element, black, Number | | Box |
| GTIN (EAN) | 4008190087142 | of poles: 1 | | |
| Qty. | 50 pc(s). | | | |

BLF 5.08HC/09/180 SN OR BX

Weidmüller Interface GmbH & Co. KG
Klingenbergstraße 26
D-32758 Detmold
Germany

www.weidmueller.com

Drawings

Product benefits

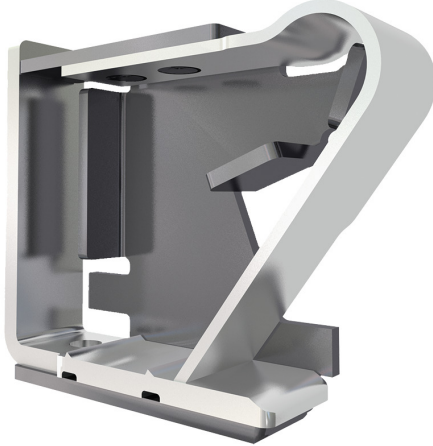

Solid PUSH IN contact
Safe and durable

Product benefits

Product benefits



Cost-effective wiring
Quick and intuitive operation

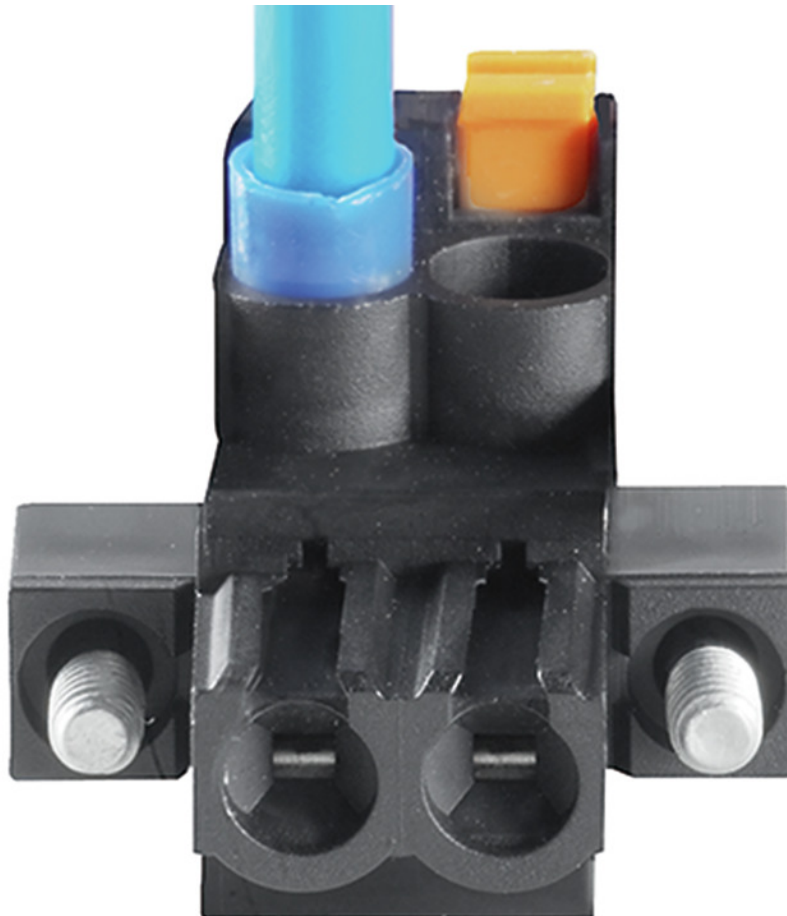

Wide clamping range
Tool-free wire connection

The reproduction, distribution and utilization of this document as well as the communication of its contents to others without explicit authorization is prohibited. Offenders will be held liable for the payment of damages. Weidmueller exclusively reserves the right to file for patents, utility models or designs.

© Weidmueller Interface GmbH & Co. KG

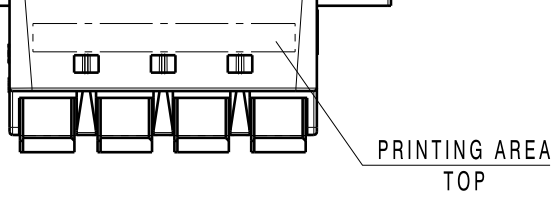

L1+0.609
FRONT PLATE CUT-OUT

M 1/1

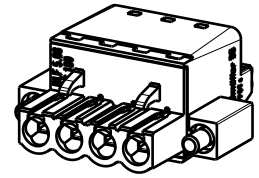

SHOWN: BLF 5.08HC/04/180LR

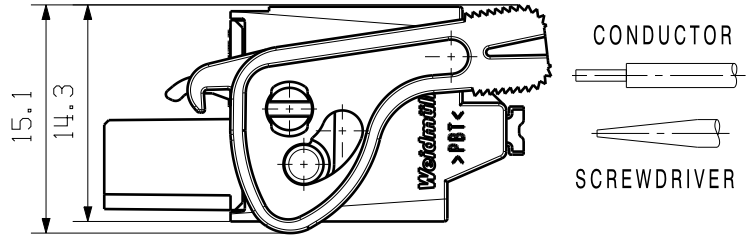
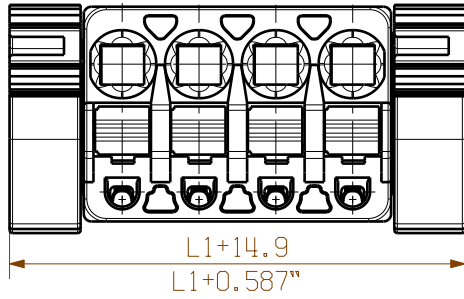

CONDUCTOR
SCREWDRIVER

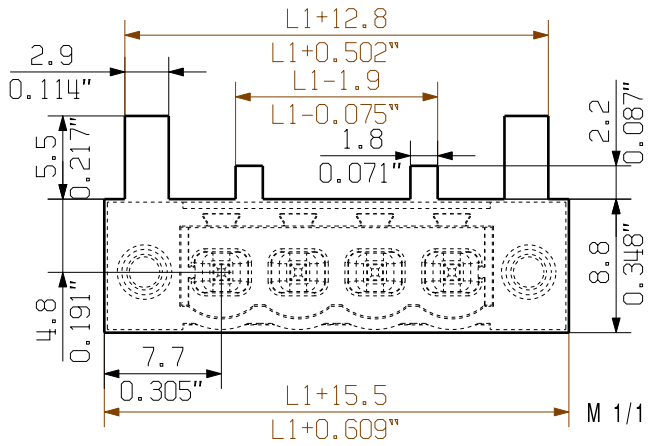
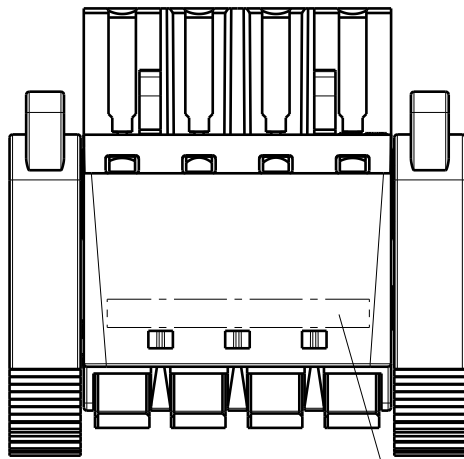

FRONT PLATE CUT-OUT

M 1/1

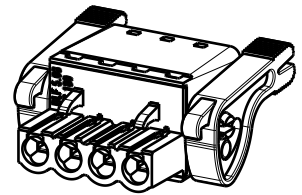

PRINTING AREA
TOP

SHOWN: BLF 5.08HC/04/180G SO

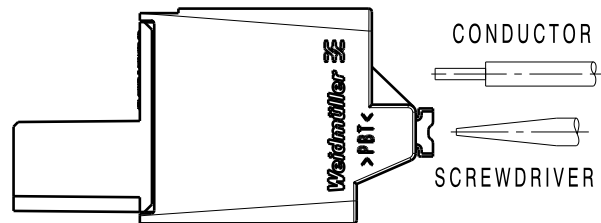
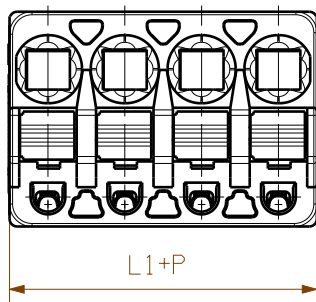

CONDUCTOR
SCREWDRIVER

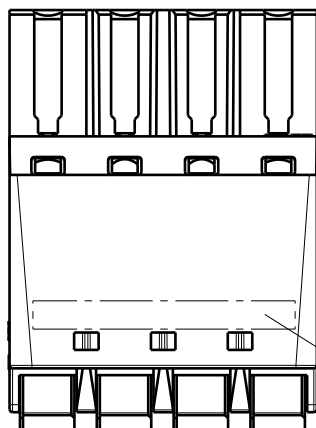

PRINTING AREA
TOP

M 1/1

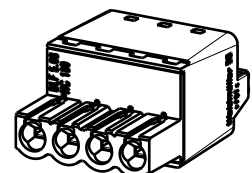

X-ON Electronics

Largest Supplier of Electrical and Electronic Components

Click to view similar products for [Pluggable Terminal Blocks](#) category:

Click to view products by [Weidmuller](#) manufacturer:

Other Similar products are found below :

[57.510.0053](#) [MC 1.5/ 6-ST-3.5 GY AU](#) [734-104](#) [734-302](#) [8-141-P](#) [8426620000](#) [860505](#) [860516](#) [860810](#) [GBPACX-12](#) [93.731.4953.0](#) [PV05-5,08-K](#) [PVP02-5,00](#) [PVP03-3,50](#) [PVP04-3,50](#) [PVS02-5,00](#) [1-1986160-3](#) [1377680000](#) [1531000000](#) [1546228-5](#) [ELFH16150](#) [ELFP03110](#) [ELFP10210](#) [ELFT06250](#) [ELVP03100](#) [1700101](#) [1700410](#) [1700425](#) [1702246](#) [1705229](#) [1710175](#) [1714537](#) [1717806](#) [1719600](#) [1728941](#) [1734692](#) [1734795](#) [1736036](#) [1740194](#) [1740291](#) [1740628](#) [1740990](#) [1746952](#) [1750207](#) [1752441](#) [1752865](#) [1754115](#) [1754144](#) [1756913](#) [1760051](#)