

WDU 4**Weidmüller Interface GmbH & Co. KG**

Klingenbergstraße 26

D-32758 Detmold

Germany

www.weidmueller.com

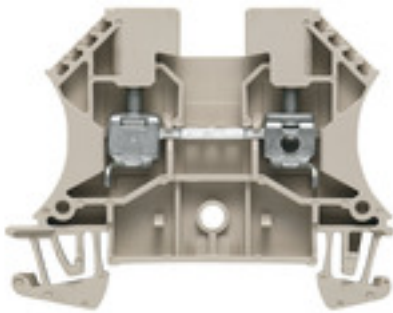
Product image**Klippon® Connect with clamping yoke Technology**

The high reliability and variety of designs of the terminal blocks with clamping yoke connections make planning easier and optimises operational safety. Klippon® Connect provides a proven response to a range of different requirements.

General ordering data

Version	Feed-through terminal, Screw connection, 4 mm ² , 800 V, 32 A, dark beige
Order No.	1020100000
Type	WDU 4
GTIN (EAN)	4008190150617
Qty.	100 pc(s).

Creation date January 8, 2022 3:11:38 AM CET

Catalogue status 17.12.2021 / We reserve the right to make technical changes.

WDU 4

Weidmüller Interface GmbH & Co. KG

Klingenbergstraße 26

D-32758 Detmold

Germany

www.weidmueller.com

Technical data

Dimensions and weights

Depth	46.5 mm	Depth (inches)	1.831 inch
Depth including DIN rail	47 mm	Height	60 mm
Height (inches)	2.362 inch	Width	6.1 mm
Width (inches)	0.24 inch	Weight	9 g
Net weight	9.57 g		

Temperatures

Storage temperature		Operating temperature range	For operating temperature range see EC Design Test Certificate / IEC Ex-Certificate of Conformity
	-25 °C...55 °C		
Continuous operating temp., min.	-60 °C	Continuous operating temp., max.	130 °C

Material data

Material	Wemid	Colour	dark beige
UL 94 flammability rating	V-0		

Rating data IECEx/ATEX

Certificate No. (ATEX)	DEMKO 14ATEX1338U	Certificate No. (IECEX)	IECEXULD14.0005U
Max. voltage (ATEX)	690 V	Current (ATEX)	32 A
Wire cross section max. (ATEX)	4 mm ²	Max. voltage (IECEX)	690 V
Current (IECEX)	32 A	Wire cross section max. (IECEX)	4 mm ²
Operating temperature range	For operating temperature range see EC Design Test Certificate / IEC Ex-Certificate of Conformity	Marking EN 60079-7	
Ex 2014/34/EU label	II 2 G D		Ex eb II C Gb

System specifications

Version	Screw connection, for plug-in cross-connector, for screwable cross-connection, One end without connector	End cover plate required	Yes
Number of potentials	1	Number of levels	1
Number of clamping points per level	2	Number of potentials per tier	1
Levels cross-connected internally	No	PE connection	No
Rail	TS 35	N-function	No
PE function	No	PEN function	No

2 clampable conductors (H05V/H07V) with equal cross-section (rated connection)

Cross-section for connected wire, solid, two clampable wires, max.	2.5 mm ²	Cross-section for connected wire, solid, two clampable wires, min.	0.5 mm ²
Wire connection cross section, finely stranded with wire-end ferrules DIN 46228/1, 2 clampable wires, max.	1.5 mm ²	Wire connection cross section, finely stranded with wire-end ferrules DIN 46228/1, 2 clampable wires, min.	0.5 mm ²
Wire connection cross section, finely stranded, two clampable wires, min.	0.5 mm ²	Wire cross-section, finely stranded, two clampable wires, max.	1.5 mm ²

WDU 4

Weidmüller Interface GmbH & Co. KG
 Klingenbergstraße 26
 D-32758 Detmold
 Germany

www.weidmueller.com

Technical data

Additional technical data

Explosion-tested version	Yes	Number of similar terminals	1
Open sides	right	Type of mounting	Snap-on

CSA rating data

Certificate No. (CSA)	200039-1057876	Current size B (CSA)	35 A
Current size C (CSA)	35 A	Voltage size C (CSA)	600 V
Wire cross section max. (CSA)	10 AWG	Wire cross section min. (CSA)	26 AWG

Conductors for clamping (rated connection)

Blade size	0.6 x 3.5 mm				
Clampable conductor	Connection specification		Screw connection		
	Cross-section for conductor connection		Type	solid, H05(07) V-U	
			min.	0.5 mm ²	
			max.	6 mm ²	
			nominal	4 mm ²	
	wire end ferrule		Stripping length	min.	10 mm
				max.	10 mm
				nominal	10 mm
			Tightening torque	min.	0.5 Nm
	max.	1 Nm			
	Recommended wire-end ferrule				
	Connection specification		Screw connection		
	Cross-section for conductor connection		Type	stranded, H07V-R	
			min.	1.5 mm ²	
			max.	6 mm ²	
			nominal	4 mm ²	
	wire end ferrule		Stripping length	min.	10 mm
				max.	10 mm
				nominal	10 mm
			Tightening torque	min.	0.5 Nm
	max.	1 Nm			
	Recommended wire-end ferrule				
	Connection specification		Screw connection		
	Cross-section for conductor connection		Type	flexible, H05(07) V-K	
min.			0.5 mm ²		
max.			6 mm ²		
nominal			4 mm ²		
wire end ferrule		Stripping length	min.	10 mm	
			max.	10 mm	
			nominal	10 mm	
		Tightening torque	min.	0.5 Nm	
max.	1 Nm				
Recommended wire-end ferrule					
Clamping range, max.	6 mm ²				
Clamping range, min.	0.13 mm ²				
Clamping screw	M 3				
Connection cross-section, stranded, max.	6 mm ²				
Connection cross-section, stranded, min.	1.5 mm ²				
Connection direction	on side				

Creation date January 8, 2022 3:11:38 AM CET

WDU 4

Weidmüller Interface GmbH & Co. KG

Klingenbergstraße 26

D-32758 Detmold

Germany

www.weidmueller.com

Technical data

Gauge to IEC 60947-1	A4
Number of connections	2
Stripping length	10 mm
Tightening torque, max.	1 Nm
Tightening torque, min.	0.5 Nm
Torque level with DMS electric screwdriver	2
Twin wire-end ferrules, max.	2.5 mm ²
Twin wire-end ferrules, min.	0.5 mm ²
Type of connection	Screw connection
Wire connection cross section AWG, max.	AWG 10
Wire connection cross section AWG, min.	AWG 26
Wire connection cross section, finely stranded, max.	6 mm ²
Wire connection cross section, finely stranded, min.	0.5 mm ²
Wire connection cross-section, finely stranded with wire-end ferrules DIN 46228/1, max.	4 mm ²
Wire connection cross-section, finely stranded with wire-end ferrules DIN 46228/1, min.	0.5 mm ²
Wire connection cross-section, finely stranded with wire-end ferrules DIN 46228/4, max.	4 mm ²
Wire connection cross-section, finely stranded with wire-end ferrules DIN 46228/4, min.	0.5 mm ²
Wire connection cross-section, solid core, max.	6 mm ²
Wire connection cross-section, solid core, min.	0.5 mm ²

General

Rail	TS 35	Standards	IEC 60947-7-1
Wire connection cross section AWG, max.	AWG 10	Wire connection cross section AWG, min.	AWG 26

Rating data

Rated cross-section	4 mm ²	Rated voltage	800 V
Rated current	32 A	Current at maximum wires	41 A
Standards	IEC 60947-7-1	Volume resistance according to IEC 60947-7-x	1 mΩ
Rated impulse withstand voltage	8 kV	Power loss in accordance with IEC 60947-7-x	1.02 W
Pollution severity	3		

UL rating data

Certificate No. (UR)	E60693	Conductor size Factory wiring max. (UR)	10 AWG
Conductor size Factory wiring min. (UR)	26 AWG	Conductor size Field wiring max. (UR)	10 AWG
Conductor size Field wiring min. (UR)	22 AWG	Current size C (UR)	35 A
Voltage size C (UR)	600 V		

Creation date January 8, 2022 3:11:38 AM CET

Catalogue status 17.12.2021 / We reserve the right to make technical changes.

WDU 4

Weidmüller Interface GmbH & Co. KG

Klingenbergstraße 26

D-32758 Detmold

Germany

www.weidmueller.com

Technical data

Classifications

ETIM 6.0	EC000897	ETIM 7.0	EC000897
ETIM 8.0	EC000897	ECLASS 9.0	27-14-11-20
ECLASS 9.1	27-14-11-20	ECLASS 10.0	27-14-11-20
ECLASS 11.0	27-14-11-20		

Approvals

Approvals



ROHS	Conform
UL File Number Search	E60693

Downloads

Approval/Certificate/Document of Conformity	Attestation of Conformity IECEX Certificate CB Testreport CB Certificate EAC certificate DNVGL certificate NEMKO certificate INMETRO certificate Lloyds Register Certificate MARITREG Certificate POLSKIREJ certificate EAC EX Certificate CCC Ex Certificate CE Declaration of Conformity ATEX Certificate CE Declaration of Conformity all terminals
Engineering Data	CAD data – STEP
Engineering Data	EPLAN, WSCAD, Zuken E3.S
User Documentation	NTI WDU/WPE 4 StorageConditionsTerminalBlocks
Catalogues	Catalogues in PDF-format
Brochures	

Data sheet

WDU 4

Weidmüller Interface GmbH & Co. KG
Klingenbergstraße 26
D-32758 Detmold
Germany

www.weidmueller.com

Drawings



WDU 4

Weidmüller Interface GmbH & Co. KG
 Klingenbergstraße 26
 D-32758 Detmold
 Germany

www.weidmueller.com

Accessories

WS 12/6

**WS/ DEK**

MultiMark terminal markers use an innovative composite material made from two components. The hard base contour of the marker snaps securely into the connector. The elastic surface finish makes the marker easy to mount. This specially punched material enables the strips to be stretched to accommodate the slight variations in spacing that tend to add up, especially with long terminal blocks. Another advantage: the excellent printability of the surface material guarantees durable and wear-resistant labelling. A print resolution of 300 dpi also produces a very legible script.

Your benefits with MultiMark

- Firm hold and durable printing
- Continuous strips save installation time
- Easy mounting thanks to an innovative composite material
- Large label field for optimal legibility
- High flexibility thanks to manufacturer independence

General ordering data

Type	WS 12/6 MM WS	Version
Order No.	2007200000	WS, Terminal marker, 12 x 6 mm, Weidmueller, white
GTIN (EAN)	4050118391886	
Qty.	600 pc(s).	

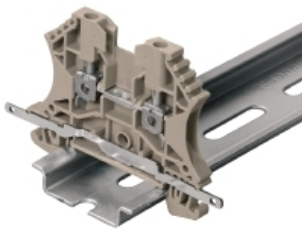
Shielding connection**Shielding and earthing**

Our protective earth conductor and shielding terminals featuring different connection technologies allow you to effectively protect both people and equipment from interference, such as electrical or magnetic fields. A comprehensive range of accessories rounds off our range.

General ordering data

Type	LS 2.8 WDU2.5-10	Version
Order No.	1056400000	W-Series, Shield bus
GTIN (EAN)	4008190036454	
Qty.	100 pc(s).	

WDU 4

Weidmüller Interface GmbH & Co. KG
 Klingenbergstraße 26
 D-32758 Detmold
 Germany

www.weidmueller.com

Accessories

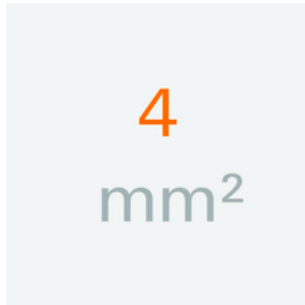
4 mm²

The plug-in cross-connections feature easy handling and quick installation. This saves a great deal of time during installation in comparison with screwed solutions.

General ordering data

Type	ZQV 4N/30 BL
Order No.	2561610000
GTIN (EAN)	4050118569971
Qty.	5 pc(s).
Type	ZQV 4N/50 RD
Order No.	2460730000
GTIN (EAN)	4050118476156
Qty.	5 pc(s).
Type	ZQV 4N/5
Order No.	1527980000
GTIN (EAN)	4050118332759
Qty.	60 pc(s).
Type	ZQV 4N/50 BL
Order No.	1528240000
GTIN (EAN)	4050118333121
Qty.	5 pc(s).
Type	ZQV 4N/3 BL
Order No.	1528080000
GTIN (EAN)	4050118333008
Qty.	60 pc(s).
Type	ZQV 4N/3
Order No.	1527940000
GTIN (EAN)	4050118332865
Qty.	60 pc(s).
Type	ZQV 4N/5 BL
Order No.	1528140000
GTIN (EAN)	4050118333015
Qty.	60 pc(s).
Type	ZQV 4N/30
Order No.	2561580000
GTIN (EAN)	4050118570113
Qty.	5 pc(s).
Type	ZQV 4N/4
Order No.	1527970000
GTIN (EAN)	4050118332889
Qty.	60 pc(s).
Type	ZQV 4N/30 RD
Order No.	2561600000
GTIN (EAN)	4050118569964
Qty.	5 pc(s).

Creation date January 8, 2022 3:11:38 AM CET

WDU 4

Weidmüller Interface GmbH & Co. KG
 Klingenbergstraße 26
 D-32758 Detmold
 Germany

www.weidmueller.com

Accessories

Type	ZQV 4N/6 BL
Order No.	1528170000
GTIN (EAN)	4050118332926
Qty.	20 pc(s).
Type	ZQV 4N/8 BL
Order No.	1528190000
GTIN (EAN)	4050118332858
Qty.	20 pc(s).
Type	ZQV 4N/4 BL
Order No.	1528120000
GTIN (EAN)	4050118332872
Qty.	60 pc(s).
Type	ZQV 4N/3 RD
Order No.	2460810000
GTIN (EAN)	4050118476231
Qty.	60 pc(s).
Type	ZQV 4N/10 BL
Order No.	1528230000
GTIN (EAN)	4050118333138
Qty.	20 pc(s).
Type	ZQV 4N/8
Order No.	1528030000
GTIN (EAN)	4050118332841
Qty.	20 pc(s).
Type	ZQV 4N/7 RD
Order No.	2460770000
GTIN (EAN)	4050118476194
Qty.	20 pc(s).
Type	ZQV 4N/5 RD
Order No.	2460790000
GTIN (EAN)	4050118476217
Qty.	60 pc(s).
Type	ZQV 4N/9
Order No.	1528070000
GTIN (EAN)	4050118332797
Qty.	20 pc(s).
Type	ZQV 4N/6 RD
Order No.	2460780000
GTIN (EAN)	4050118476200
Qty.	20 pc(s).
Type	ZQV 4N/9 RD
Order No.	2460750000
GTIN (EAN)	4050118476170
Qty.	20 pc(s).
Type	ZQV 4N/4 RD
Order No.	2460800000
GTIN (EAN)	4050118476224
Qty.	60 pc(s).
Type	ZQV 4N/7
Order No.	1528020000
GTIN (EAN)	4050118332780
Qty.	20 pc(s).

Creation date January 8, 2022 3:11:38 AM CET

WDU 4

Weidmüller Interface GmbH & Co. KG
 Klingenbergstraße 26
 D-32758 Detmold
 Germany

www.weidmueller.com

Accessories

Type	ZQV 4N/9 BL
Order No.	1528220000
GTIN (EAN)	4050118333107
Qty.	20 pc(s).
Type	ZQV 4N/2 BL
Order No.	1528040000
GTIN (EAN)	4050118332773
Qty.	60 pc(s).
Type	ZQV 4N/50
Order No.	1528130000
GTIN (EAN)	4050118332902
Qty.	5 pc(s).
Type	ZQV 4N/7 BL
Order No.	1528180000
GTIN (EAN)	4050118333114
Qty.	20 pc(s).
Type	ZQV 4N/10
Order No.	1528090000
GTIN (EAN)	4050118332896
Qty.	20 pc(s).
Type	ZQV 4N/8 RD
Order No.	2460760000
GTIN (EAN)	4050118476187
Qty.	20 pc(s).
Type	ZQV 4N/2
Order No.	1527930000
GTIN (EAN)	4050118332766
Qty.	60 pc(s).
Type	ZQV 4N/2 RD
Order No.	2460450000
GTIN (EAN)	4050118476149
Qty.	60 pc(s).
Type	ZQV 4N/6
Order No.	1527990000
GTIN (EAN)	4050118332919
Qty.	20 pc(s).
Type	ZQV 4N/10 RD
Order No.	2460740000
GTIN (EAN)	4050118476163
Qty.	20 pc(s).

WDU 4

Weidmüller Interface GmbH & Co. KG
 Klingenbergstraße 26
 D-32758 Detmold
 Germany

www.weidmueller.com

Accessories

DEK 5/6



WS/ DEK

MultiMark terminal markers use an innovative composite material made from two components. The hard base contour of the marker snaps securely into the connector. The elastic surface finish makes the marker easy to mount. This specially punched material enables the strips to be stretched to accommodate the slight variations in spacing that tend to add up, especially with long terminal blocks. Another advantage: the excellent printability of the surface material guarantees durable and wear-resistant labelling. A print resolution of 300 dpi also produces a very legible script.

Your benefits with MultiMark

- Firm hold and durable printing
- Continuous strips save installation time
- Easy mounting thanks to an innovative composite material
- Large label field for optimal legibility
- High flexibility thanks to manufacturer independence

General ordering data

Type	DEK 5/6 MM WS	Version	
Order No.	2007120000	Dekafix, Terminal marker, 5 x 6 mm, Weidmueller, white	
GTIN (EAN)	4050118392104		
Qty.	600 pc(s).		

2.5-10 mm²

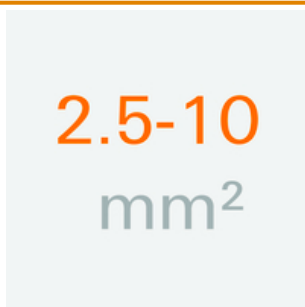

End plates are fitted to the open side of the last modular terminal before the end bracket. The use of an end plate ensures the function of the modular terminal and the specified rated voltage. It guarantees protection against contact with live parts and makes the final terminal finger-proof.

General ordering data

Type	WAP 16+35 WTW 2.5-10	Version	
Order No.	1050100000	W-Series, End plate, Partition plate	
GTIN (EAN)	4008190079901		
Qty.	20 pc(s).		
Type	WAP 2.5-10	Version	
Order No.	1050000000	W-Series, End plate	
GTIN (EAN)	4008190103149		
Qty.	50 pc(s).		

WDU 4

Weidmüller Interface GmbH & Co. KG
 Klingenbergstraße 26
 D-32758 Detmold
 Germany

www.weidmueller.com

Accessories

Type	WAP 2.5-10 BL	Version
Order No.	1050080000	W-Series, End plate
GTIN (EAN)	4008190136611	
Qty.	50 pc(s).	
Type	WAP 16+35 WTW 2.5-10 BL	Version
Order No.	1050180000	W-Series, End plate, Partition plate
GTIN (EAN)	4008190013899	
Qty.	20 pc(s).	

W-Series



Test adapters and test plugs are used for the electrical connection between terminal blocks and the test equipment. In this way, an electrical contact can be established in the wired state and measurements can be done easily.

General ordering data

Type	WTA 3/ZA WDU4	Version
Order No.	1632360000	W-Series, Test adapter
GTIN (EAN)	4008190209704	
Qty.	25 pc(s).	
Type	WTA 3 WDU4	Version
Order No.	1632350000	W-Series, Test adapter
GTIN (EAN)	4008190209711	
Qty.	25 pc(s).	

Testsockets



Test adapters and test plugs are used for the electrical connection between terminal blocks and the test equipment. In this way, an electrical contact can be established in the wired state and measurements can be done easily.

General ordering data

Type	STB 8.5/5/2.3/M3 SAK2.5	Version
Order No.	0280600000	Accessories, Socket
GTIN (EAN)	4008190023188	
Qty.	50 pc(s).	

WDU 4

Weidmüller Interface GmbH & Co. KG
Klingenbergstraße 26
D-32758 Detmold
Germany

www.weidmueller.com

Accessories

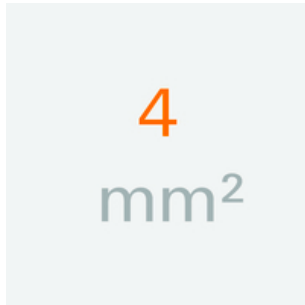
4 mm²

Screwable cross-connections are easy to mount and de mount. Thanks to the big contact surface, even high currents can be transmitted with maximum contact reliability.

General ordering data

Type	WQV 4/3	Version
Order No.	1054560000	W-Series, Cross-connector, For the terminals, Number of poles: 3
GTIN (EAN)	4008190168971	
Qty.	50 pc(s).	
Type	WQV 4/2	Version
Order No.	1051960000	W-Series, Cross-connector, For the terminals, Number of poles: 2
GTIN (EAN)	4008190026486	
Qty.	50 pc(s).	
Type	WQV 4/4	Version
Order No.	1054660000	W-Series, Cross-connector, For the terminals, Number of poles: 4
GTIN (EAN)	4008190095758	
Qty.	50 pc(s).	
Type	WQV 4/10	Version
Order No.	1052060000	W-Series, Cross-connector, For the terminals, Number of poles: 10
GTIN (EAN)	4008190054687	
Qty.	20 pc(s).	

W-Series



A partition plate is used for the optical separation of circuits or used for electrical isolation from neighbouring cross-connectors. In contrast to the end plate, the contour can be larger than the adjacent terminal blocks. However, it should not be smaller, as otherwise the required clearance and creepage distances within the application can no longer be maintained.

General ordering data

Type	WTW EN	Version
Order No.	1058800000	W-Series, Partition plate
GTIN (EAN)	4008190140175	
Qty.	20 pc(s).	

WDU 4

Weidmüller Interface GmbH & Co. KG
 Klingenbergstraße 26
 D-32758 Detmold
 Germany

www.weidmueller.com

Accessories

SchT group marker carrier

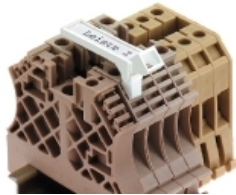

The SchT 5 S group tag carriers are clipped directly onto the TS 32 mounting rail (G-rail) or the TS 35 mounting rail (top-hat rail). It is therefore possible to label the terminal strip irrespective of the terminal and the type of terminal. SchT 5 and SchT 5 S are fitted with ESO 5, STR 5 protective strips.

The SchT 7 is a hinged group tag carrier for inlay tags which enables easy access to the clamping screw. The SchT 7 is fitted with ESO 7, STR 7 protective strips or DEK 5.

Inlay tags and protective strips can be found under "Accessories".

General ordering data

Type	SCHT 7	Version
Order No.	0517960000	SCHT, Terminal marker, 39.3 x 8 mm, Pitch in mm (P): 7.00
GTIN (EAN)	4008190001742	Weidmueller, white
Qty.	20 pc(s).	

Blank



The Dekafix (DEK) marker is the universal marker for all conductor and plug-in connectors as well as for electronic sub-assemblies. The system is ideal for short number sequences and covers a wide range of ready-printed markers.

Strips for fast installation in only one work step. The printing is easy to read, rich in contrast and available in various widths.

- Large range of ready-to-use markers
- Strips for fast installation
- Terminal markers, suitable for all Weidmüller cable connectors
- Available as blank MultiCard or with standard printing

For custom printing: Please send us a file of our labeling software M-Print PRO or M-Print PRO Online (without installation) for your labeling specifications.

General ordering data

Type	DEK 5/6 MC NE WS	Version
Order No.	1609820000	Dekafix, Terminal marker, 5 x 6 mm, Pitch in mm (P): 6.00
GTIN (EAN)	4008190203436	Weidmueller, white
Qty.	1,000 pc(s).	

WDU 4

Weidmüller Interface GmbH & Co. KG
Klingenbergstraße 26
D-32758 Detmold
Germany

www.weidmueller.com

Accessories

W-Series



Weidmüller's range of products includes end brackets that guarantee a permanent, reliable mounting on the terminal rail and prevent sliding. Versions with and without screws are available. The end brackets include marking options, also for group markers, and also a test plug holder.

General ordering data

Type	WEW 35/2	Version
Order No.	1061200000	W-Series, End bracket
GTIN (EAN)	4008190030230	
Qty.	50 pc(s).	

Blank



WS markers are the perfect match for the W-series connectors. Thanks to their system compatibility, the WS tags can also be used with the I-series and the Z-series. The large marking surfaces do not only permit long character strings but also multi-line text. WS markers are ideal for labels with long, customised character strings. Thanks to the proven MultiCard format, printing with PrintJet CONNECT oder/or Plotter is possible.

- Can be fitted in strips or individually
- Markers in proven MultiCard format

For custom printing: Please send us a file of our labeling software M-Print PRO or M-Print PRO Online (without installation) for your labeling specifications.

General ordering data

Type	WS 12/6 MC NE WS	Version
Order No.	1609900000	WS, Terminal marker, 12 x 6 mm, Pitch in mm (P): 6.00 Weidmueller,
GTIN (EAN)	4008190203467	Allen-Bradley, white
Qty.	600 pc(s).	

WDU 4

Weidmüller Interface GmbH & Co. KG
Klingenbergstraße 26
D-32758 Detmold
Germany

www.weidmueller.com

Accessories

ZGB pivotable group tag holder

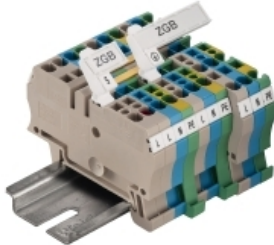

The ZGB 15 is a hinged group tag carrier. The tag carrier can hold the dekafix 5, WS 12/5 terminal markers or the inlay tag ESO 15.

The ZGB 30 is a hinged group tag carrier. The tag carrier can hold the dekafix 5, WS 12/5 terminal markers or the inlay tag ESO 7.

Inlay tags and protective strips can be found under "Accessories".

General ordering data

Type	ZGB 30	Version
Order No.	1611930000	Terminal markers, Terminal marker, 32 x 7 mm, Pitch in mm (P): 5.00
GTIN (EAN)	4008190002251	Weidmueller, white
Qty.	20 pc(s).	
Type	ZGB 15	Version
Order No.	1636530000	Terminal markers, Terminal marker, 15 x 7 mm, Pitch in mm (P): 5.00
GTIN (EAN)	4008190297053	Weidmueller, white
Qty.	20 pc(s).	

Test sockets



Current and voltage transformer wiring

Our test disconnect terminal blocks featuring spring and screw connection technology allow you to create all the important converter circuits for measuring current, voltage and power in a safe and sophisticated way.

General ordering data

Type	STB 21.6/IH/BL WTL6/3	Version
Order No.	1071080000	Accessories, Socket
GTIN (EAN)	4008190043957	
Qty.	50 pc(s).	
Type	STB 21.6/IH/VI WTL6/3	Version
Order No.	1071030000	Accessories, Socket
GTIN (EAN)	4008190259235	
Qty.	50 pc(s).	
Type	STB 21.6/IH/WS WTL6/3	Version
Order No.	1312520000	Accessories, Socket
GTIN (EAN)	4050118121704	
Qty.	50 pc(s).	
Type	STB 21.6/IH/SW WTL6/3	Version
Order No.	1071040000	Accessories, Socket
GTIN (EAN)	4008190859985	
Qty.	50 pc(s).	

WDU 4

Weidmüller Interface GmbH & Co. KG

Klingenbergstraße 26

D-32758 Detmold

Germany

www.weidmueller.com

Accessories

Type	STB 21.6/IH/RT WTL6/3	Version
Order No.	1778990000	Accessories, Socket
GTIN (EAN)	4032248169665	
Qty.	50 pc(s).	
Type	STB 21.6/IH/GE WTL6/3	Version
Order No.	1071010000	Accessories, Socket
GTIN (EAN)	4008190259211	
Qty.	50 pc(s).	
Type	STB 21.6/IH/GN WTL6/3	Version
Order No.	1071020000	Accessories, Socket
GTIN (EAN)	4008190259228	
Qty.	50 pc(s).	
Type	STB 21.6/IH/DB WTL6/3	Version
Order No.	1071000000	Accessories, Socket
GTIN (EAN)	4008190259204	
Qty.	50 pc(s).	

Blank



The WAD connector marker is suitable for W-series terminals and for the WEW 35/2 and ZEW 35/2 end brackets. The markers are available as blank markers, with custom printing or standard print with lightning symbol. The WAD MultiCard markers are suitable for labelling with PrintJet CONNECT printers.

For custom printing: Please send us a file of our labeling software M-Print PRO or M-Print PRO Online (without installation) for your labeling specifications.

General ordering data

Type	WAD 5 MC NE GE	Version
Order No.	1112920000	Group markers, Cover, 33.3 x 5 mm, Pitch in mm (P): 5.00 yellow
GTIN (EAN)	4032248891771	
Qty.	48 pc(s).	
Type	WAD 5 MC NE WS	Version
Order No.	1112910000	Group markers, Cover, 33.3 x 5 mm, Pitch in mm (P): 5.00 white
GTIN (EAN)	4032248891689	
Qty.	48 pc(s).	

X-ON Electronics

Largest Supplier of Electrical and Electronic Components

Click to view similar products for [DIN Rail Terminal Blocks](#) category:

Click to view products by [Weidmuller](#) manufacturer:

Other Similar products are found below :

[00110420202](#) [8WA1011-1BH23](#) [8WA1011-1EF20](#) [91.010](#) [9102100000](#) [91.040](#) [9123140000](#) [9123140001](#) [RBO 5-T-B-HEX](#) [1333564](#) [DP25-GY-ND](#) [1431306](#) [1433306](#) [NFT2-WH](#) [HSL-TB64-DIN](#) [90.070](#) [91.020](#) [912314](#) [260-301_NR](#) [2757571](#) [280-331](#) [280-560](#) [280-564](#) [281-611/281-542](#) [281-673/281-411](#) [281-994](#) [283-317](#) [283-607](#) [2909798](#) [264-724](#) [264-726](#) [280-530](#) [280-555](#) [280-619](#) [281-610](#) [281-622/281-417](#) [284-317](#) [284-601](#) [2907033](#) [3048496](#) [5542152](#) [35956](#) [USK 10](#) [102510](#) [1025100000](#) [5520682](#) [5607102](#) [EMH 25-ZE30](#) [591620-2](#) [UM 45-SEFE M.NUT BK](#)