

- |                        |             |                      |
|------------------------|-------------|----------------------|
| Argentina              | Indonesia   | Saudi Arabia         |
| Australia              | Iran        | Serbia               |
| Austria                | Ireland     | Singapore            |
| Azerbaijan             | Israel      | Slovakia             |
| Bahrain                | Italy       | Slovenia             |
| Belarus                | Japan       | South Africa         |
| Belgium                | Jordan      | Spain                |
| Bosnia and Herzegovina | Kazakhstan  | Sweden               |
| Brazil                 | Korea       | Switzerland          |
| Bulgaria               | Kuwait      | Taiwan               |
| Canada                 | Latvia      | Thailand             |
| Chile                  | Lebanon     | Tunisia              |
| China                  | Lithuania   | Turkey               |
| Colombia               | Luxembourg  | Ukraine              |
| Costa Rica             | Macedonia   | United Arab Emirates |
| Croatia                | Malaysia    | United States        |
| Czech Republic         | Malta       | Uruguay              |
| Denmark                | Mexico      | Uzbekistan           |
| Ecuador                | Moldova     | Venezuela            |
| Egypt                  | Netherlands | Vietnam              |
| Estonia                | New Zealand |                      |
| Finland                | Norway      |                      |
| France                 | Oman        |                      |
| Germany                | Pakistan    |                      |
| Great Britain          | Peru        |                      |
| Greece                 | Philippines |                      |
| Hong Kong              | Poland      |                      |
| Hungary                | Portugal    |                      |
| Iceland                | Qatar       |                      |
| India                  | Romania     |                      |
|                        | Russia      |                      |

Weidmüller is a leading international provider of solutions for electrical connectivity, transmission and conditioning of power, signal and data in industrial environments.

The company with headquarters in Detmold/Germany develops, produces and sells products in the field of electrical connectivity and electronics all over the world. Via a network of application specialists Weidmüller offers engineering services and develops application specific solutions.

The complete product and service portfolio consistently assures both Weidmüller and its customers of competitive advantages and an increase in value.

Catalogue 2011

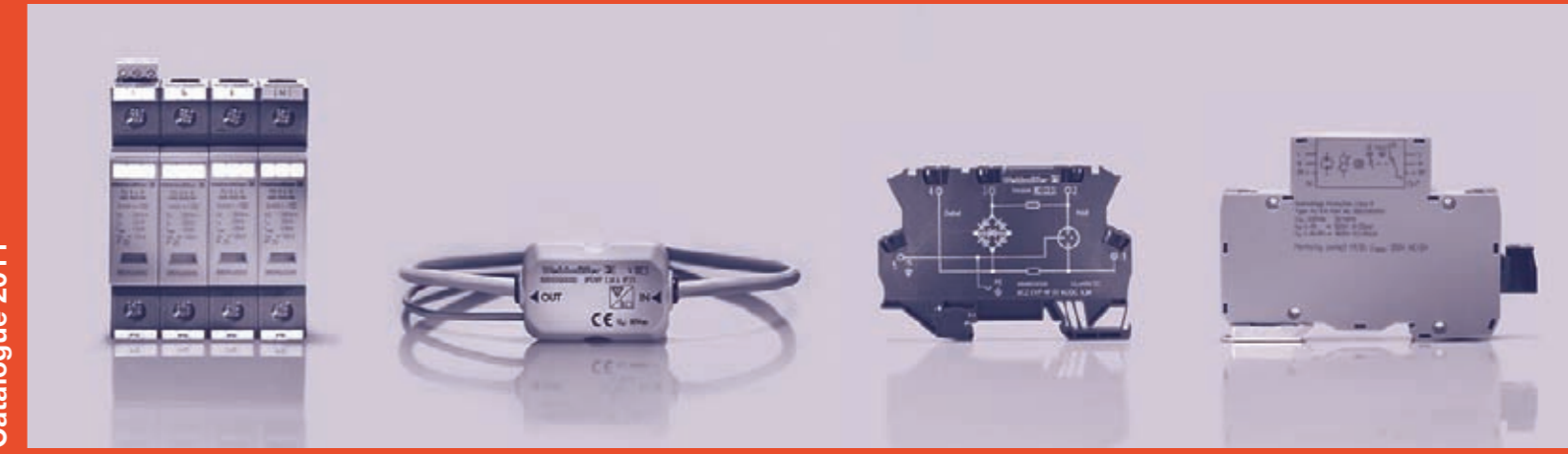

# Electronics Surge protection

Catalogue

Electronics – Surge protection

Order number:  
1271290000/01/2011/SMMD



# Product Portfolio

Weidmüller is a leading international provider of solutions for electrical connectivity, transmission and conditioning of power, signal and data in industrial environments. The company with headquarters in Detmold/Germany develops, produces and sells products in the field of electrical connectivity and electronics all over the world.

[www.power-signal-data.com](http://www.power-signal-data.com)

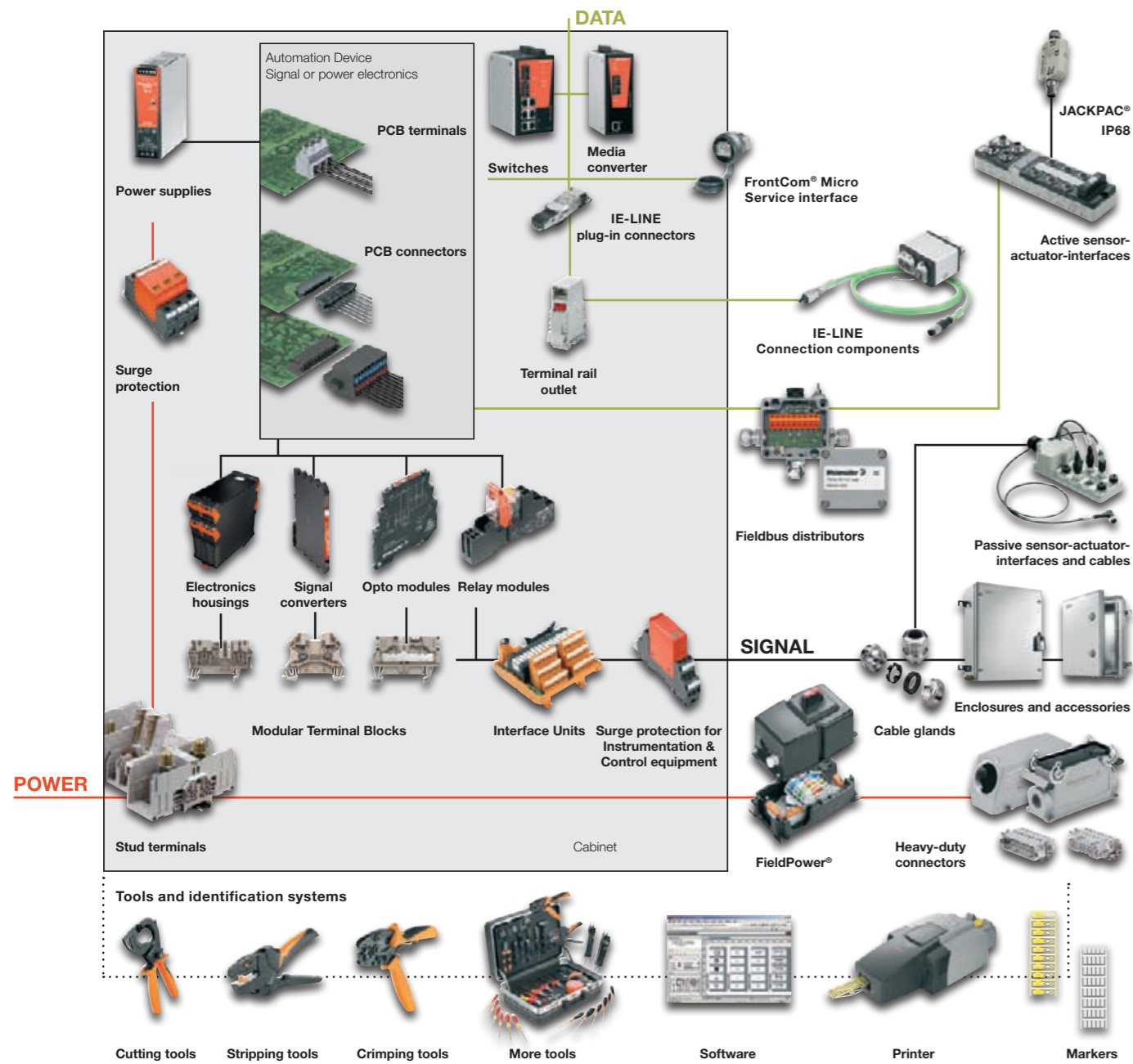

**All the catalogues at a glance**

Catalog	Product	Order No.
Catalog 1	Modular Terminal Blocks	5661400000
Catalog 2	PCB Terminals, PCB Connectors and Housings for Electronics	1000310000
Catalog 3	RockStar® – Heavy Duty Connectors	5664240000
Catalog 4.1	Electronics – Analogue Signal Conditioning	1203510000
Catalog 4.2	Electronics – Relays and Optos	1158120000
Catalog 4.3	Electronics – Power Supplies	1158070000
Catalog 4.4	Electronics – Surge protection	1271290000

Catalog	Product	Order No.
Catalog 4.5	Electronics – Interface units and PLC solutions	1102340000
Catalog 5	Enclosures and Cable Glands	5661920000
Catalog 6	Tools	1161520000
Catalog 7	Identification systems	1125590000
Catalog 8	Sensor Actuator Interface	1235620000
Catalog 9	Industrial Ethernet	1067180000
Product information	FieldPower® – decentralised power distribution	1229860000

# Examples of applications in 230/400 V systems

**TN-C system application**

**TN-C 230/400 V**

**Ordering data**

Class I (B arrester)	Light. protect. class	Type	Order No.	Page	Remarks
Sparkover gap	I / II	3 x PU1 TSG 35 kA/0.9 kV-260 V	8561260000	B.11	No decoupling necessary
or High-power varistor	III / IV	PU I 3 280 V/12.5 kA	8858990000	B.14	No decoupling necessary
Class II (C arrester)	Type	Order No.	Page	Remarks	
Varistor	PU II 3 280 V/40 kA	8859630000	B.22		
Class III (D arrester)	Type	Order No.	Page	Remarks	
Hybrid circuit	PU III 230 V/16 A	8860330000	B.41	Install behind RCD, with FM contact	
or Hybrid circuit	PU D ZS	8697560000	B.48	plugg. for socket outlet with earth. contact	

**TN-C-S system application**

**TN-C-S 230/400 V with 3+1 circuit and TN-S system with 4-pole protection circuit**

**Ordering data**

Class I (B arrester)	Light. protect. class	Type	Order No.	Page	Remarks
Sparkover gap	I / II	3 x PU1 TSG 35 kA/0.9 kV-260 V	8561260000	B.11	No decoupling necessary
	II / III / IV	1 x PU1 TSG 50 kA/0.9 kV-260 V	8561230000	B.11	as N-PE sparkover gap
	III / IV	3 x PU BC	8805440000	B.13	No decoupling necessary
	III / IV	1 x PU1 TSG 50 kA/0.9 kV-260 V	8561230000	B.11	as N-PE sparkover gap
	III / IV	1 x PU I 3 280 V/12.5 kA	8858990000	B.14	No decoupling necessary
	III / IV	1 x PU1 TSG 50 kA/0.9 kV-260 V	8561230000	B.11	as N-PE sparkover gap
Class II (C arrester)	Type	Order No.	Page	Remarks	
Varistor + N-PE	PU II 3+1 280 V/40 kA 3+1 circuit	8859710000	B.24	Inclusive N-PE sparkover gap	
or Varistor	PU II 4 280 V/40 kA	8859640000	B.22	Install behind RCD	
Class III (D arrester)	Type	Order No.	Page	Remarks	
Hybrid circuit	PU III 230 V/16 A	8860330000	B.41	Install behind RCD, with FM contact	
or Hybrid circuit	PU D ZS	8697560000	B.48	plugg. for socket outlet with earth. contact	

**TT system application**

**TT 230/400V with 3+1 circuit**

**Ordering data**

Class I (B arrester)	Light. protect. class	Type	Order No.	Page	Remarks
Sparkover gap	I / II	3 x PU1 TSG 35 kA/0.9 kV-260 V	8561260000	B.11	No decoupling necessary
	III / IV	1 x PU1 TSG 50 kA/0.9 kV-260 V	8561230000	B.11	as N-PE sparkover gap
	III / IV	3 x PU BC	8805440000	B.13	No decoupling necessary
	III / IV	1 x PU1 TSG 50 kA/0.9 kV-260 V	8561230000	B.11	as N-PE sparkover gap
	III / IV	1 x PU I 3 280 V/12.5 kA	8858990000	B.14	No decoupling necessary
	III / IV	1 x PU1 TSG 50 kA/0.9 kV-260 V	8561230000	B.11	as N-PE sparkover gap
Class II (C arrester)	Type	Order No.	Page	Remarks	
Varistor + N-PE	PU II 3+1 280 V/40 kA 3+1 circuit	8859710000	B.24	Inclusive N-PE sparkover gap	
or Varistor	PU II 4 280 V/40 kA	8859640000	B.22	Install behind RCD	
Class III (D arrester)	Type	Order No.	Page	Remarks	
Hybrid circuit	PU III 230 V/16 A	8860330000	B.41	Install behind RCD, with FM contact	
or Hybrid circuit	PU D ZS	8697560000	B.48	plugg. for socket outlet with earth. contact	

**IT system application**

**IT 230/400 V with 3+1 circuit**

**Ordering data**

Class I (B arrester)	Light. protect. class	Type	Order No.	Page	Remarks
Sparkover gap	I / II	3 x PU1 TSG 35 kA/0.9 kV-260 V	8561260000	B.11	No decoupling necessary
	III / IV	3 x PU BC	8805440000	B.13	No decoupling necessary
	III/IV	1x PU1 TSG 50 kA/0.9 kV-260 V	8561230000	B.11	as N-PE sparkover gap
	III/IV	1 x PU I 3 280 V/12.5 kA	8858990000	B.14	No decoupling necessary
	III/IV	1 x PU1 TSG 50 kA/0.9 kV-260 V	8561230000	B.11	as N-PE sparkover gap
	III/IV	1 x PU1 TSG 50 kA/0.9 kV-260 V	8561230000	B.11	as N-PE sparkover gap
Class II (C arrester)	Type	Order No.	Page	Remarks	
Varistor + N-PE	PU III 3+1 280 V/40 kA 3+1 circuit	8859710000	B.24	Inclusive N-PE sparkover gap	
or Varistor	PU II 4 280 V/40 kA	8859640000	B.22	Install behind RCD	
Class III (D arrester)	Type	Order No.	Page	Remarks	
Hybrid circuit	PU III 230 V/16 A	8860330000	B.41	Install behind RCD, with FM contact	
or Hybrid circuit	PU D ZS	8697560000	B.48	plugg. for socket outlet with earth. contact	

For further applications / voltage levels, please ask Weidmüller. All class II arresters and PU BC also available with telecommunication contact.

# Surge protection 2011

	The basics of Surge protection	<b>A</b>
	Surge protection Innovations 2010/2011	<b>B</b>
	Surge protection for low-voltage supplies	<b>C</b>
	Surge protection for instrumentation and control equipment	<b>D</b>
	Surge protection for data interfaces	<b>E</b>
	Surge protection for photovoltaic systems	<b>F</b>
	Things worth knowing about surge protection	<b>G</b>

Contents

Appendix

Index  
Search according to Type or order number, Addresses worldwide

X

## Surge protection Innovations 2010/2011

### VARITECTOR SPC

Page B.8

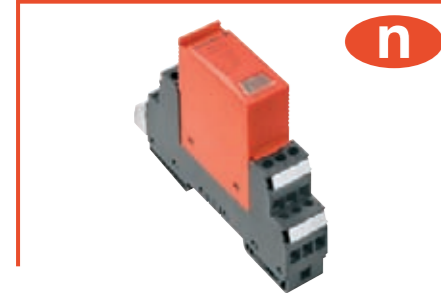

Pluggable surge protection for C&I circuits ( IEC 61643-21)

### VARITECTOR SPC EX

Page B.36

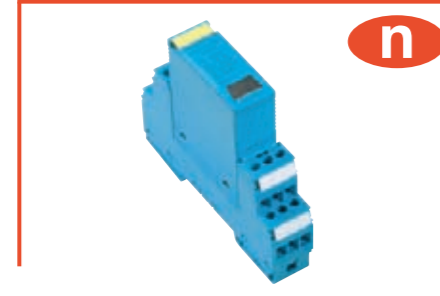

Pluggable surge protection for intrinsically safe current loops for gas and dust atmosphere up to zone 0

### VARITECTOR SSC 6AN

Page B.48



2-stage surge protection with 6 screw-connection for C&I circuits (IEC 61643-21)

### VARITECTOR SSC 4AN

Page B.72



2-stage surge protection with 4 screw-connection for C&I circuits (IEC 61643-21)

### PU II 750 V

Page B.82



Pluggable overvoltage protection class II for 750 V application, e.g. wind power

### PU I TSG+

Page B.86



Enclosed lightning arrester class I up to 100 kA (10/350  $\mu$ s) for installation in front of the meter. (lightning protection Level 1)



## Surge protection for low-voltage supplies

### PU I series

Page C.11, B.49

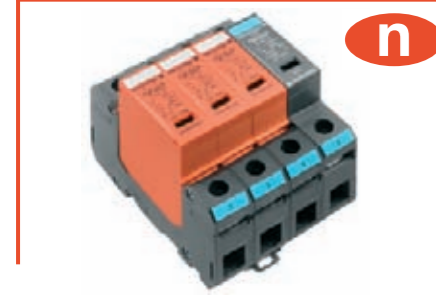

Class I + II plug-in arrester for lightning protection equipotential bonding. Suitable for lightning protection level III and IV

### PU BC/PU BCR

Page C.13



Class I + II plug-in arrester for lightning protection equipotential bonding. Suitable for lightning protection level II and III

### PU 1 TSG

Page C.14



Enclosed lightning arrester class I up to 35/50 kA (10/350 μs), 17.5 mm wide, for use in main distribution boards, 230 V

### PU 1 TSG, N-PE path

Page C.15



Enclosed lightning arrester class I up to 100 kA (10/350 μs), 35 mm wide, for insertion between N and PE

### PU 1 TSG+

Page C.16



Lightning arrester class I up to 50 kA (10/350 μs) per unit with triggered sparkover gap for industrial main distribution boards, 330 V

### PU 1 TSG+

Page C.16



Lightning arrester class I up to 50 kA (10/350 μs) per unit, with triggered sparkover gap for industrial main distribution boards, 440 V

### Combination arrester

Page C.20



Combination arrester for 4-conductor and 5-conductor system

### PU II series

Page C.24



Surge voltage protector class II, with varistors for main distribution or subdistribution boards (also with remote signalling contact)

### PU III series

Page C.45



Surge voltage protector class III, single-phase with gas discharge tube and varistor for equipment protection, slimline model with remote signalling contact

## Surge protection for low-voltage supplies / instrumentation and control equipment

### PO DS

Page C.49



Surge voltage protector class III, single-phase with gas discharge tube and varistor for equipment protection, build-in module with visual indication

### Wavefilter

Page C.58



Mains filter, 3/6/10 A, with screw connection for 230 V devices or voltage supplies

### MCZ HF

Page D.7

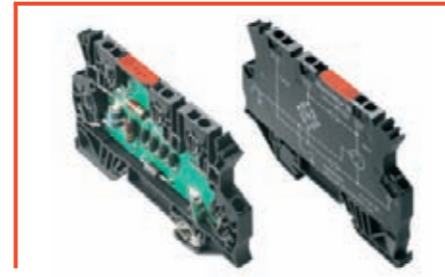

Measurement and control surge protection for binary and analogue signals. In a thin design (6 mm) with tension clamp connection and mounting rail contact

### MCZ CL/SL

Page D.9

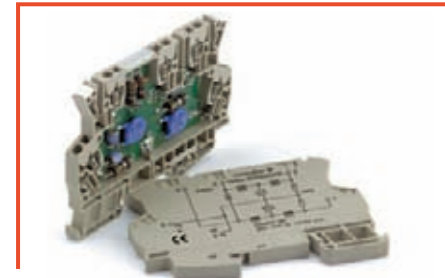

Instrumentation and control engineering surge protection for binary and analogue signals, slimline model (6 mm) with tension spring connection and mounting rail contact

### MCZ Filter

Page D.16

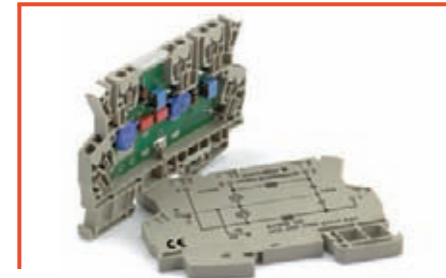

Instrumentation and control engineering filter for analogue signals, slimline model (6 mm) with tension spring connection and mounting rail contact

### MCZ GDT, MOV, TAZ

Page D.17

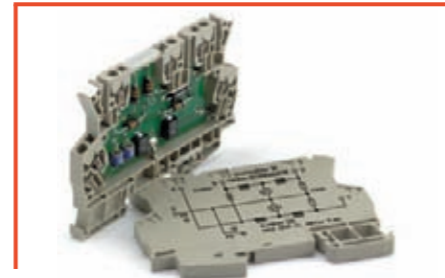

Instrumentation and control engineering surge protection with individual protective elements (GDT, MOV, TAZ), slimline model (6 mm) with tension spring connection and mounting rail contact

### LPU

Page D.41



Instrumentation and control engineering surge protection for binary and analogue signals, plug-in model with screw connection (connection variations and test option)

# Surge protection for instrumentation and control equipment

## DKU

Page D.20



Instrumentation and control engineering surge protection for binary and analogue signals, slimline model (5 mm) with screw connection

## DK5U

Page D.22

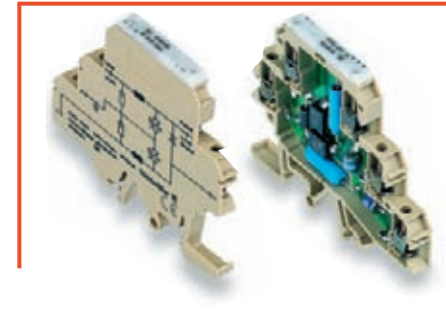

Instrumentation and control engineering surge protection for binary and analogue signals, slimline model (6 mm) with screw connection

## DK6U

Page D.23

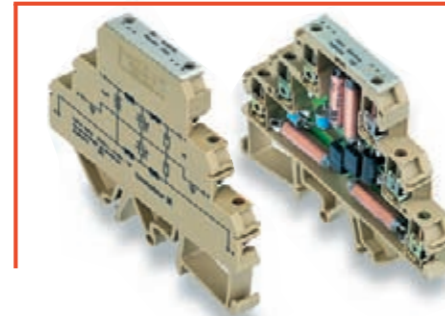

Instrumentation and control engineering surge protection for binary and analogue signals, slimline model (8 mm) with screw connection

## DK4U

Page D.24



Instrumentation and control engineering surge protection with individual protective elements (GDT, MOV, TAZ), slimline model with screw connection

## DK4RC

Page D.26

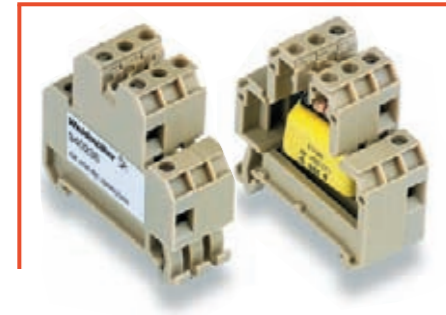

RC combination, suppressor circuit for contactors and solenoid valves, with screw connection

## EGU 1/2

Page D.29



Two-stage instrumentation and control engineering surge protection for binary signals, with integral fuse (5 x 20 mm) and screw connection

## EGU 3 / EGU 4

Page D.30



Two- and three-stage surge protection for binary and analogue signals up to 1.5 A, with rotating clip-in foot.

## JACKPAC®

Page D.32



Single- and three-stage surge protection in IP67 quality: for protecting binary switching signals up to 24 V, or for analogue measuring circuits with 0...20 mA or 0...10 V.

## RSU 6/10 A

Page D.36



Three-stage surge protection for analogue signals with high current requirement, or for power supplies in instrumentation and control systems

## Surge protection for data interfaces

### EGU 4 RS232

Page E.4



Surge protection for RS 232 data interface in EG4 housing, with screw connection

### ZS RS232

Page E.4



Surge protection for RS 232 data interface in flat connector housing, available as plug or socket connector

### LPU RS485 / RS422

Page E.5



Surge protection for RS 485 and RS 422 data interface, plug-in model with screw connection

### RS485

Page E.5



Surge protection for RS 485 data interface, in protected housing with T-junction option and optional earth connection via gas discharge tube

### LON™ Termination

Page E.6



Bus termination terminal for LON Termination LPT/FTT/TP 78, with screw connection

### MCZ OVP LON™

Page E.6

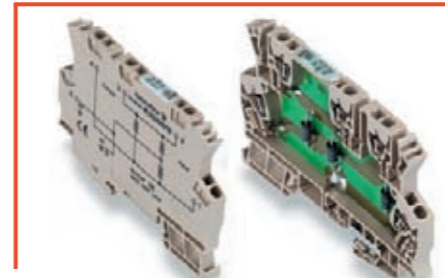

Surge protection for LON bus in MCZ housing, with tension spring connection and mounting rail contact

### DME Ethernet Cat.5

Page E.7



DME Ethernet cat.5 surge protection

### COAX

Page E.8



Surge protection for COAX interfaces, as BNC, N, F, and UHF adapter plug

### Telecommunications interfaces

Page E.13



TAE-NFN for analogue and ISDN lines



## Surge protection for photovoltaic systems

### PV box

Page F.10



PU II surge arrester, especially for photovoltaic systems



# The basics of Surge protection

<b>The basics of Surge protection</b>	Is surge protection worthwhile?	A.2
	Electromagnetic compability	A.4
	What are overvoltages?	A.5
	How do overvoltages occur?	A.6
	Prevention is better than cure	A.10
	How do we achieve surge protection?	A.11
	Classification and protective zones	A.12
	Components for Surge protection	A.14
	Lightning protection classes	A.17
	Network forms	A.18
	Office building with lightning protection	A.20
	Industrial building with lightning protection	A.21
	General installation advice	A.22
	Summary of standards and regulations	A.23
	Surge protection concept	A.24

**A**



## Is surge protection worthwhile?

A



### You can rely on luck or take precautions.

The priority you give to surge protection depends on your willingness to take risks! Perhaps you think "it'll never happen to me". Then you won't have lost anything, but will have gained only very little. However, the subject of overvoltage is then a daily worry for you.

But if you wish to be on the safe side, you should include surge protection in your corporate strategy. Such an investment brings you operational reliability and can prove invaluable when disaster strikes.

### Disaster comes from the sky

The violent forces of nature in the form of a thunderstorm are a spectacular show. Potentially, this is a dangerous event for human beings and no less dangerous for industrial and commercial premises and equipment.

While a person is mainly exposed to the risk of a lightning strike in his or her immediate vicinity, this is not the case for electrical equipment. Lightning strikes up to 2 km away can damage electrical components.

Apart from this, electrical systems are considerably more sensitive to the indirect effects of the energy of a bolt of

lightning. Lightning strikes generate secondary voltages in anything that conducts and therefore endanger the insulation of electrical equipment.

The number of lightning strikes per annum in Europe alone are considerable. Lightning strikes are registered worldwide. You can get the latest figures by visiting the Internet address [www.wetteronline.de/eurobli.htm](http://www.wetteronline.de/eurobli.htm).

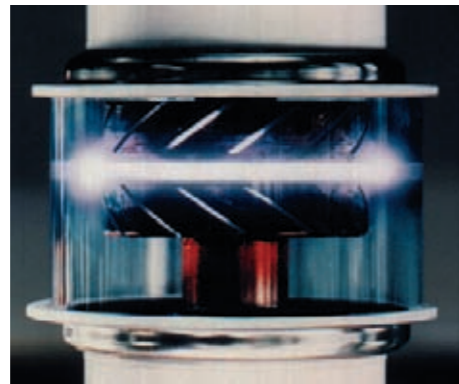

Electric arc in a 10 kV switch while being switched off





#### But disaster also comes from inside

And to a much greater extent than from the sky. Wherever electricity is used, it must also be switched on and off. And the physical processes of a switching operation can also cause overvoltages.

These overvoltages are nowhere near as high as those of lightning. But as they are generated directly in the lines, they are also directly in the system and place a stress on the insulation. Although switching operations are not as spectacular as lightning strikes, they do take place more frequently. Added to this are overvoltages caused by electrostatic discharges or faulty switching operations.

#### Protection would seem to be a matter of common-sense

Our modern working lives would be inconceivable without power supply systems, instrumentation and control equipment, IT networks and much more besides. They have become matter-of-fact and we realise their significance only when they break down. The potential scenarios range from a brief interruption in the work to bankruptcy. Good protection can prevent that.

#### Surge protection is a topic for today

Surge protection is an important aspect of electromagnetic compatibility and is required by law. There have been many technical improvements in the field of surge protection over the years. The quality and quantity of surge protection systems have increased. This is also revealed by the statistics of the umbrella organisation for the German insurance industry: the annual total damages for the insurance of electronic equipment has fallen slightly despite the fact that more electronic equipment is almost certainly being used and electrical and electronic systems are becoming increasingly complex with the degree of integration ever higher.

Nevertheless, each year in Germany about 450,000 claims are registered across the whole electronic spectrum.

The total loss in Germany for 2005 amounted to 230 mio. €. It is estimated that about one-third of these are due to overvoltages.

#### Voltages that exceed the limits

Surges are voltages that exceed the normal values. These normal values determine the insulation, which is designed and tested according to the appropriate regulations. The degree of insulation varies depending on the type of electrical equipment. We therefore speak of "insulation coordination".

An item for use with 230 V, e.g. an electric motor, is fitted with insulation tested with a few kilovolts. It is obvious that a chip on a PCB operating with 5 V cannot have the same dielectric strength. For this chip 10 V could mean disaster.



Component destroyed

#### Surge protection calls for special knowledge

Surge protection must differentiate in order to take into account insulation coordination. It must be able to deal with high voltages at high currents just as safely as low voltages at low currents. These could be completely normal in other parts of the system.

Therefore, surge protection is a complex subject.

It comprises of not just one electrical component but rather several functional elements combined in one circuit. This calls for special engineering expertise – not just for the provision of functional surge protection modules, but also for their utilisation, planning and installation.

Therefore, this catalogue does not just present our products but instead provides comprehensive information to help you understand the subject of surge protection.

# Electromagnetic compatibility

EMC – electromagnetic compatibility – means the trouble-free interaction between electrical and electronic systems and devices without mutual interference. In this respect, any electrical item can act both as transmitter (source of interference) and receiver (potentially susceptible device) simultaneously.

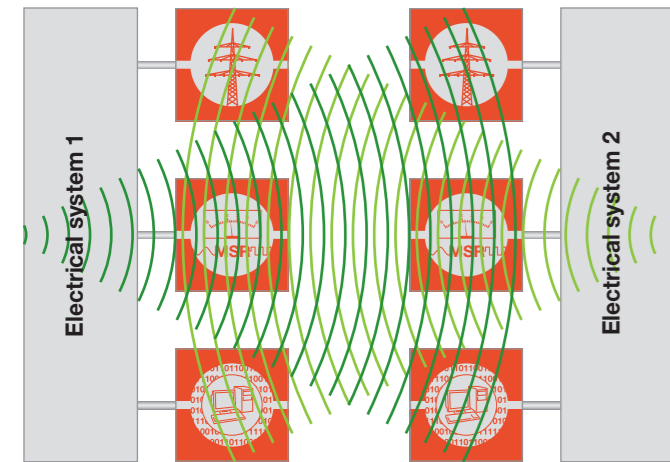

## EMC laws and directives

There are a multitude of standards and statutory requirements aimed at controlling mutual interference-free operation. As the Single European Market was set up in 1989, an EEC directive covering electromagnetic compatibility was passed and subsequently ratified by the governments of the member states. In Germany this is covered by the Electromagnetic Compatibility Act, passed on 9 November 1992. There was a period of transition in which the 1992 Act, the Radio Interference Act of 1979 and the High-Frequency Equipment Act of 1949 were all valid. However, since 1 January 1996 only the 1992 Act has been valid. The second amendment to the Act has been in force since 25 September 1998. Electromagnetic influences can be caused by natural processes, e.g. a lightning strike, and also technical processes, e.g. high-speed changes in the status of currents and voltages.

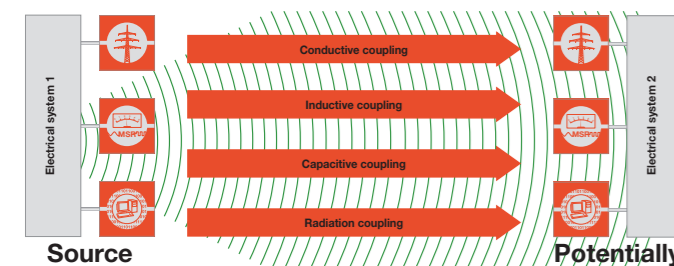

We distinguish between periodic interference (system hum, RF irradiation), transient interference (brief, often high-energy pulses) and noise (broad distribution of interference energy across the frequency range).

The model used in EMC observations designates the transmitter as the **source of interference** emission and the receiver as the **interference drain**. The transmission of the interference takes place via line-bound and/or field-bound (H-field/E-field) coupling mechanisms.

When considered as a source of interference, a device or a system may not exceed emissions thresholds specified in the EMC standards.

When considered as a potentially susceptible device, the same system must exhibit the immunity to interference specified in the standards.

However, the arrangement of various electrical systems within a complex plant or in a room and the many lines for power supplies, inputs and outputs to controls and bus systems give rise to diverse potential influences. Surges can be introduced by lightning, switching operations, etc. via the various coupling paths. This can lead to the following effects:

- reduced functionality
- malfunctions
- failure of functions
- damage

These last two functional interferences result in stoppages for entire production facilities and cause high breakdown costs.

The following points must be taken into account in order to achieve a system or plant that operates according to EMC guidelines:

- lightning protection
- earthing
- routing of cables
- cable shielding
- panel construction
- sensors and actuators
- transmitters and receivers
- frequency converters
- bus and field devices
- ESD



# What are overvoltages?

## Surge protection (OVP) installations

Constructing an electrical or electronic system in accordance with EMC guidelines using suitable components is generally not sufficient to guarantee operation free from interference. Only by employing **surge protection systems** at the appropriate points in a plant is it possible to achieve operation without breakdowns caused by coupled surges. The procedure for the use of surge protection systems is also linked to the model of influences between interference source and potentially susceptible device and be integrated in a comprehensive protective system in conjunction with a lightning protection zoning concept and insulation coordination.

## What are surges?

Surges are extremely high voltages that damage or even completely destroy insulation and hence impair or completely disrupt the function of electrical and electronic components of all kinds. Every electrical component is provided with insulation to isolate the electrical voltage from earth or other voltage-carrying parts. The insulation strength is dependent on the rated voltage and the type of electrical component, as stipulated by the IEC/VDE regulations. It is tested by applying the prescribed voltages for a defined period of time.

If the test voltage is exceeded in operation, the safety effect of the insulation is no longer guaranteed. The component can be damaged or completely ruined. Surges are the voltage pulses that are higher than the test voltage and therefore could have a detrimental effect on the respective electrical component or system. This means that components with a high rated voltage may be capable of withstanding a surge voltage. But components with a lower rated voltage would be very much at risk from the same surge. An overvoltage allowable in an electric motor can spell disaster for an electronic circuit!

Permanently higher voltages also occur with the 50/60 Hz mains frequency. These voltages can be coupled or may occur as a result of faulty switching operations. The resulting continuous interference voltages are then another case for overvoltage protection.

Individual surge pulses, which have a high frequency because of their physical formation, have a current rise that is about ten thousand times steeper compared with 50 Hz voltage. If the current rise time in the 50/60 Hz range is 5 ms, then for an overvoltage it is around 1  $\mu$ s.

These surges are designated as "transient" voltages.

This means that they are short-lived, temporary oscillations. Their shape and frequency depends on the impedance of the circuit.

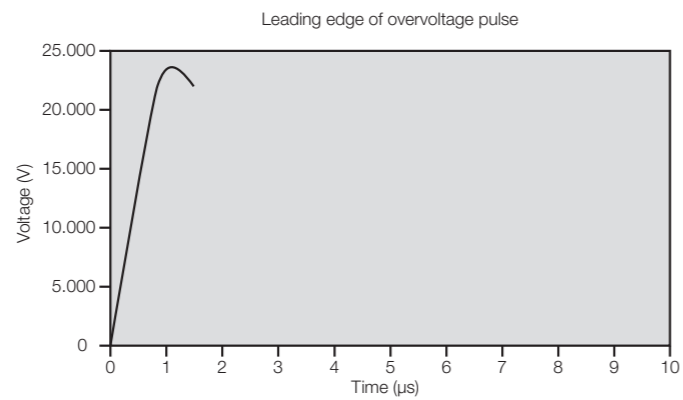
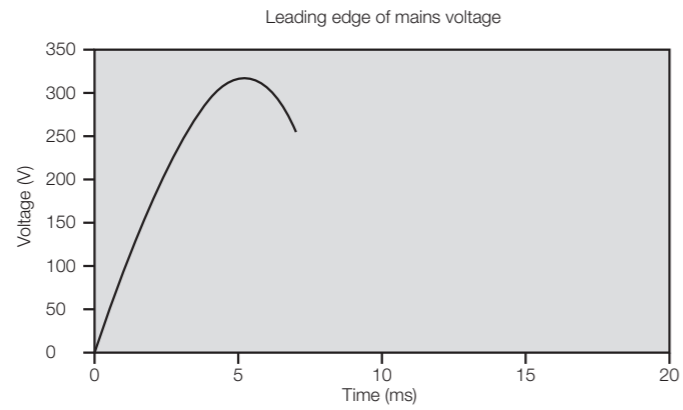

# How do overvoltages occur?

Surges are primarily caused by:

- transient switching operations
- lightning due to atmospheric discharges
- electrostatic discharges
- faulty switching operations

## Lightning

Bolts of lightning exhibit extremely high currents. Therefore, they cause a large voltage drop and, accordingly, a large rise in potential even in well-earthed buildings or systems despite low earthing resistances.

This will then cause a galvanic, inductive or capacitive coupling of surge voltages within the circuits of electrical or electronic facilities. It will also penetrate through the insulation.

### Conductive coupling

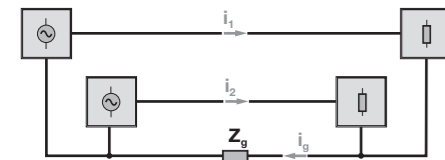

Surges are transferred directly into circuits via common earthing impedances. The magnitude of the overvoltage depends on the amperage of the lightning and the earthing conditions. The frequency and the wave behaviour are mainly determined by the inductance and the speed of the current rise. Even distant lightning strikes can lead to overvoltages in the form of travelling waves, which affect different parts of electrical systems by way of conductive coupling.

### Inductive coupling

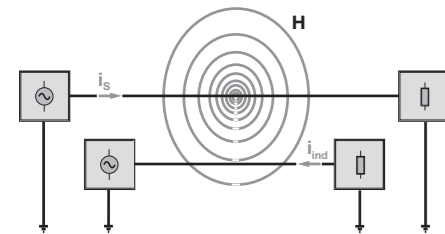

A high-amperage lightning strike generates a strong magnetic field. Starting from here, overvoltages reach nearby circuits by means of an induction effect (e.g. directly earthed conductor, power supply lines, data lines, etc.). According to the transformer

principle, the coupling of induced voltages is considerable owing to the high-frequency current  $di/dt$  – even when primary and secondary windings consist of only a single winding each, i.e. the inductance is low.

### Capacitive coupling

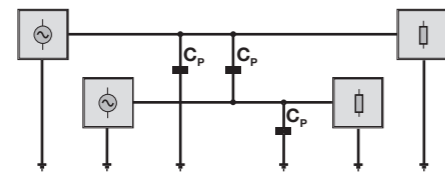

A capacitive coupling of overvoltages is also possible. The high voltage of the lightning generates an electric field with a high field strength. The transport of electrons can cause a capacitive decay to circuits with lower potentials and raise the potential concerned to an overvoltage level.

### Radiation coupling

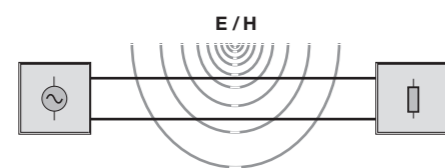

Electromagnetic wave fields (E/H field), that also ensue during lightning (distant field condition, E/H field vectors perpendicular to each other), affect conductor structures in such a way that coupled overvoltages must be expected even without direct lightning strikes. Permanent wave fields from strong transmitters are also able to cause coupled interference voltages in lines and circuits.

### Switching operations – transients

More often, it is switching operations that cause interference rather than lightning. High-amperage shutdowns in the mains in particular can generate considerable overvoltages. Switching operations generate overvoltages because, due to their construction, switching contacts that switch the current on or off do not operate in synchronisation with the current zero of an alternating current. This means that in the majority of cases there is a very rapid change of current, from a high value to zero ( $di/dt$ ). Owing to the impedances in the circuit concerned, this leads to transient overvoltages with high-frequency oscillations and high voltage peaks. These can reach electrical components by conductive, inductive or capacitive means and endanger or damage





them. The situation is similar in the case of short-circuits in the mains because these also represent a rapid switching operation.

**Electrostatic discharges – ESD**

Electrostatic discharges (ESD) caused by frictional charges are well known. You can experience them when getting out of a car or walking across a carpet. These discharges can be over 10,000 volts in strength. We speak of ESD when these discharge to a lower potential. If such a charge strikes, for example, electronic components, then these can be completely ruined.

**Faulty switching operations**

Again and again, we experience faulty switching operations in the 50/60 Hz mains. This can be caused by a failed power supply unit controller or incorrect wiring in a panel. The relatively high voltages that can occur as a result also represent dangerous overvoltages. Protection against these is vital.

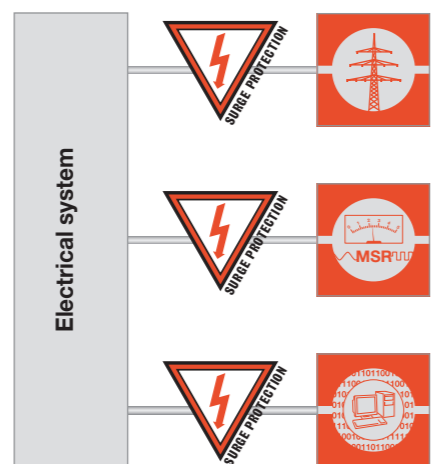

**Description of interference voltages**

Surges that occur between current-carrying conductors or between a current-carrying conductor and the neutral conductor are designated as transverse voltages or symmetrical interference.

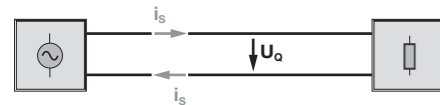

Surges that occur between a current-carrying conductor and the protective earth conductor are designated as longitudinal voltages or asymmetrical interference.

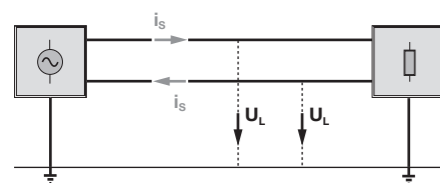

**The forms of interference voltage**

Basically, coupled transient overvoltages are either normal-mode or common-mode interference measured as a longitudinal or transverse voltage. The interference voltages occur as symmetrical, unsymmetrical or asymmetrical voltages depending on the particular systems involved.

**Normal-mode interference** (symmetrical interference)

A voltage between supply and return conductor, differential mode voltage/current. Occurs mainly at low interference frequencies in the existing lines. The interference current causes an interference voltage  $U_0$  directly at the interference sink (between the input terminals). With galvanic or inductive coupling, both the effective sources and the interference sources are connected serially. Series connection of load and interference source, e.g. in the case of inductive (magnetic field) or conductive coupling (common impedance).

In symmetrical circuits (non-earthed or virtual potential earthed), the normal-mode interference occurs as symmetrical voltages. In unsymmetrical circuits (earthed one side), the normal-mode interference occurs as unsymmetrical voltages.

**How do overvoltages occur?****Transverse voltage  $U_{\perp}$**  (normal-mode voltage)

Coupled transient interference voltage between two active conductors. In the case of unsymmetrical circuits with earth potential, the transverse voltage is equal to the longitudinal voltage. It is limited by twisting groups of associated wires together and providing one or more layers of shielding by way of cable sheathing. This reduces the induction of transverse voltages.

**Common-mode interference** (unsymmetrical interference)

Voltage between conductor and reference potential (earth), common-mode voltage/current. Mainly caused by a capacitive coupling (electrical field).

Therefore, significant common-mode interference currents only flow at higher interference frequencies. The interference voltage at the potentially susceptible device is caused by different voltage drops at the supply and return conductors (in each case between input terminal and reference earth). Source of interference between signal wire and reference conductor, e.g. due to a capacitive coupling or an increase in reference potential between separate earths.

In symmetrical circuits, common-mode interference occurs as asymmetrical voltages between the d.c. offset of the circuit and the reference earth. The forward and return conductors have the same interference voltages compared to the reference ground. In unsymmetrical circuits, common-mode interference occurs as unsymmetrical voltages between the individual conductors and the reference earth.

**Longitudinal voltage  $U_{\parallel}$**  (common-mode voltage)

Coupled transient interference voltage between an active conductor and the earth potential. As a rule, the longitudinal voltage is higher than the transverse voltage (transverse voltage is lower owing to cable shielding and twisting).

Longitudinal voltages caused by lightning currents on cable shielding can assume quite high values, especially in the case of long lines entering a building from the outside.

**Symmetrical, unsymmetrical and asymmetrical interference voltages**

The symmetrical interference voltage is measured between the supply and return conductors of a circuit.

$$U_{\text{sym}} = U_{\text{unsym},1} - U_{\text{unsym},2}$$

The unsymmetrical interference voltage is measured between one conductor and the reference potential (earth) of a circuit.

$$U_{\text{unsym},1} = U_{\text{sym}} + U_{\text{unsym},2}$$

$$U_{\text{unsym},2} = U_{\text{unsym},1} - U_{\text{sym}}$$

The asymmetrical interference voltage is measured between the d.c. offset and the reference potential (earth) of a circuit.

$$U_{\text{asym}} = (U_{\text{unsym},1} + U_{\text{unsym},2}) / 2$$

**Normal-mode interference in symmetrical circuit**

1. Series connection between voltage source and consumer.  
Circuit designed without reference potential or virtual potential has connection to reference potential. Interference voltage is added to signal because signal currents are, as a rule, normal-mode currents.
2. Symmetrical signal transmissions, e.g. as with a microphone, use two wires with shielding. Virtual potential has connection to reference potential. Symmetrical interference voltage is added to signal and asymmetrical interference voltage occurs between virtual potential and reference potential.

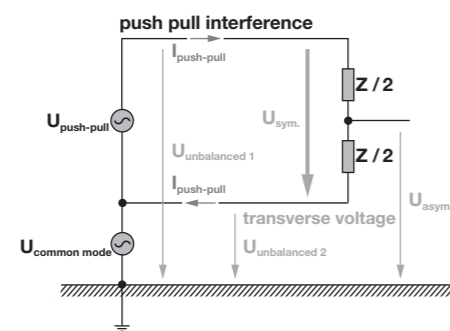
**Normal-mode interference in unsymmetrical circuit**

- Series connection between voltage source and consumer. Circuit designed with connection to reference potential, e.g. coaxial cable. Interference voltage occurs as unsymmetrical voltage between wire of one line and reference potential.



**Common-mode interference in symmetrical circuit**

Does not cause any interference voltage in ideal (completely symmetrical) circuits. However components are put under a heavier load by additional current.

**Common-mode interference in unsymmetrical circuit**

Does not cause any interference voltage in ideal (completely symmetrical) circuits.

**Common-mode interference at higher frequencies**

The parasitic impedances have a stronger influence as the frequencies increase. The common-mode voltage drives common-mode currents through the different impedances of the supply and return conductors and to earth via stray capacitances and back to the source of interference.

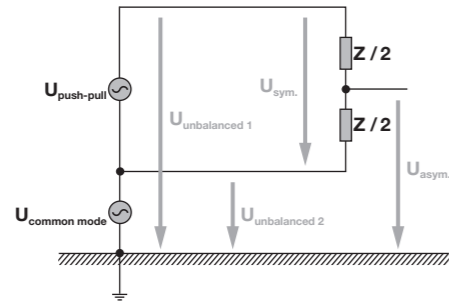

So the unequal impedances lead to the common-mode voltage becoming, for the most part, a normal-mode voltage because of the dissimilarity in the voltages to earth of the supply and return conductors.

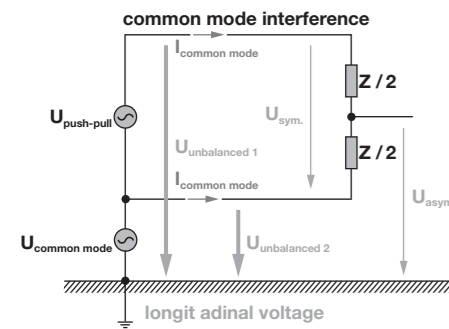

**Consequences**

The impedances and stray capacitances are equal in ideal circuits. This means that the currents in the supply and return conductors generated by coupled overvoltages are also equal and so do not generate any interference voltage. However, in practice the impedances and stray capacitances in the supply and return conductors are different. This results in unequal currents which cause different voltages to earth in the supply and return conductors.

## Prevention is better than cure

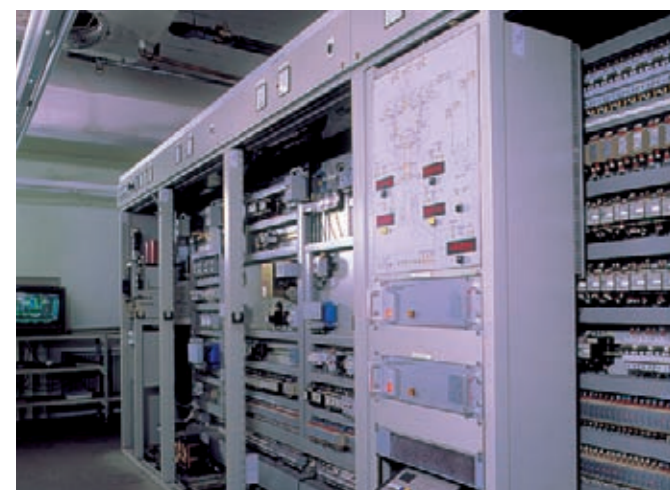

That is also true for the "health" of electrical and electronic components and systems.

Taking economic considerations into account also means investing in surge protection. This investment is only a fraction of the cost of the damage that can occur. Having to shut down a production plant because a control system has failed or the collapse of industrial data transmissions can be expensive experiences. It is not just the disruption or repairs that are expensive, the downtimes, too, have to be taken into account. The risks caused by surges are considerable. But the significant overhead in repairing the problem is not the only factor. You must also take into account the system down times. In addition, the mean time between failures is also reduced. Surge voltages present a significant danger. This is not only demonstrated by the damage statistics from property insurers. In general, all electrical equipment is threatened by surge voltages: this includes anything from free-standing high-voltage switching facilities to electronic micro-components.

For the low voltages, this risk is particularly present in the fields of power supply, measure and control technology, telecommunication, and data transmission. We offer the perfect form of surge protection for these applications fields. Surge protection has become a theme of growing significance. On the one hand, electrical and electronic components continue to get smaller. On the other side, there are increasing levels of automation in the industrial and consumer electronics sectors.

The insulation safety margins are decreasing. This, in turn, lowers the levels of tolerance. Electronic circuits function at low voltage levels of only several hundred volts. Thus surge voltages can present a significant danger. Legislators have also recognized the importance of ensuring the proper surge voltage protection. The German "Law on electromagnetic compatibility in devices" establishes the proper EMC-compliant design and layout for electrical and electronic devices.

Surge protection is an element of these EMC measures. Measures for implementing this protection are described in a variety of IEC/VDE standards. Such measures can also help in obtaining the CE mark of approval.

The subject of surge protection is rather complicated and requires special knowledge. Therefore, this catalogue provides you with some helpful information. And if you want to know more, simply contact us. We shall be happy to help and advise you.

Cause of overvoltage	Protective measures specified in:			Installation of protective devices specified in: IEC 60364-5-53
	ICE 62305-1	DIN VDE 0185-305-4	IEC 60364-4-443	
Direct lightning strike	X	X		X
Remote lightning strike	X	X	X	
Lightning fields		X		X
Switching operations			X	X



## How do we achieve surge protection?

We have to consider surge protection from two points of view:

- General protective measures during the planning and construction of buildings and electrical installations.
- Special protective measures realised by the installation of additional surge protection components.

### Planning buildings and electrical installations

Much can be done to prevent damage due to overvoltages through the careful planning and construction of buildings and electrical/electronic systems. Although these measures provide only basic protection, they can amount to cost-savings in an effective, complete protection concept. It is vital to include an adequately dimensioned earthing system right from the very first construction phase. Only this guarantees full equipotential bonding in the event of interference.

When planning the electrical installation, care must be taken to ensure that electrical systems with dissimilar rated voltages are kept separate. Corresponding protection zones can then be set up and this leads to cost-savings for the surge protection.

Furthermore, the physical separation or shielding of lines that can influence each other is a good way to achieve maximum electrical isolation. Another good option is to split up the individual phases of three-phase systems corresponding to their functions, e.g. one phase only for the supply to instrumentation and control systems.

Of course, all these primary measures do not achieve complete protection. To do this, you must install additional protective components.

### Surge protection components

Surge voltages are kept away from at-risk electrical components by first reducing them to a harmless dimension before they reach the components.

To do this, we use surge arresters that react very quickly. They must respond during the high-frequency rising phase of the overvoltage, i.e. before a dangerous value has been reached, and quench the overvoltage. The response time lies in the nanoseconds range.

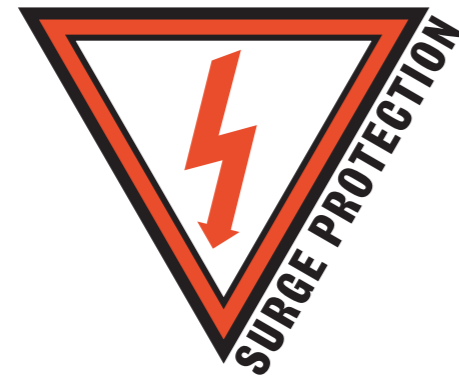

Naturally the surge protection components must be able to withstand very high currents, since a surge can, under certain circumstances, deliver several thousand amperes. At the same time, no excessive (i.e., dangerous) residual voltages should remain, even if the operating current is very high. So surge protection components must exhibit a very low resistance discharge behaviour.

Apart from that, it is absolutely essential that the surge protection component is very quickly available again in electrical terms after the surge has been quenched by earthing it. This is necessary to ensure that the function of the circuit is guaranteed.

Good surge protection is characterised by:

- fast response behaviour
- high current-carrying capacity
- low residual voltage
- good reactivation time

Weidmüller can supply protective components that fulfil these criteria. Depending on the application, these usually consist of a combination of individual components, as described in the chapter on surge components. Which combination of protective components is available for the respective application is described in the chapters B, C and D.



# Classification and protective zones

The requirements placed on surge protection and the necessary tests for surge protection components are stipulated by national and international standards.

**For rated voltages up to 1000 V AC, the standards are valid for the manufacturers of surge protection devices and the installers of the surge protection within the facility or system. This catalogue contains a list of valid standards for your reference.**

The insulation coordination for electrical equipment in low-voltage systems to IIV EN 60664-1 (IEC 60664-1) is critical for the design of surge protection. This specifies different dielectric strengths within electrical systems. Based on this, individual lightning protection zones can be set up according to IEC/EN 62305-3.

## Lightning protection zones

A protective zone is characterised by a fully earthed envelope. In other words, it has an enclosing shield which enables full equipotential bonding. This shielding can also be formed by building materials such as metal facades or metal reinforcement. Lines that pass through this shield must be protected with arresters in such a way that a prescribed protection level is achieved. Further protective zones can be set up inside such a protective zone. The protection level of these zones can be lower than that of the enclosing protective zone.

This leads to a coordinated protection level for the objects to be protected. Not every individual section has to be protected with the maximum protection level (e.g. against lightning). Instead, the individual protective zones guarantee that a certain overvoltage level is not exceeded and hence cannot infiltrate that zone.

This leads to economic protection concepts with respect to the capital outlay for protective components.

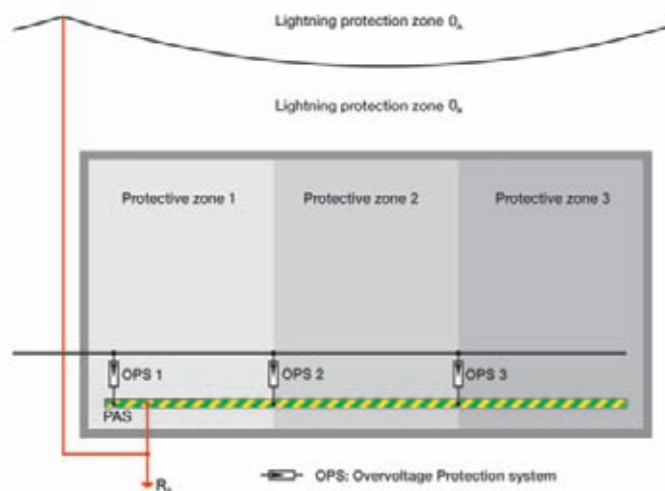

## Classification

Originally, protective zones were classified according to coarse, medium and fine protection. These protective zones were designated classes B, C and D in IEC 60099 (VDE 0675-1). There was also a class A for external arresters (e.g. for low-voltage overhead lines); however, this class has now been abolished. The IEC 61643-1 (Feb 1998) classifies the protective zones as classes I, II and III.

## Comparison of surge protection classifications.

**Many national standards, e.g. in Austria, are derived from the aforementioned VDE or IEC standards.**

Formerly IEC 60099-1	Now IEC 37A / 44 / CDV or IEC 61 643-1 (Feb 1998)
Arresters of requirements class B, lightning protection equipotential bonding to DIN VDE 0185 part 1 ("B arresters")	<b>"Class I"</b> arresters
Arresters of requirements class C, surge protection in permanent installations, surge withstand voltage category (surge cat.) III ("C arresters")	<b>"Class II"</b> arresters
Arresters of requirements class D, surge protection in mobile/permanent installations, surge withstand voltage category (surge cat.) II ("D arresters")	<b>"Class III"</b> arresters



# Test criteria

The new classification is based on the experience that “B arresters” can become overloaded in extreme situations, and also on more recent investigations into lightning discharges. This resulted in the new standardised 10/350 µs current curves for the testing of “class I” arresters. The test parameters lie between 12,5 and 25 kA Ipeak.  
 The term “10/350 µs” means that the surge current reaches 90% of its maximum value after 10 µs and then decays to half that value after 350 µs. The area beneath this curve corresponds to the current energy used in the test.  
 As in the past, “class II” arresters (formerly “C arresters”) are tested with the 8/20 µs current curve. The rated discharge current for our arresters: for a 2-pole feed up to 75 kA; for a 4-pole feed up to 100 kA. “Class III” arresters (formerly “D arresters”) are used for protecting equipment. These are tested with a 2 W hybrid surge current generator delivering a maximum charging voltage of 0.1 to max. 20 kV, which during a short-circuit supplies between 0.05 and 10 kA, 8/20 µs.

Classification			Test values	Application
formerly	VDE	IEC		
	0675	37A		
coarse protection	B-arrester	class I	$I_{wp} = 25 \text{ kA}$ 10/350 µs curve	Protection against direct lightning strike (incoming supply, main distribution board, etc.)
medium protection	C-arrester	class II	single pole $I_n = 20 \text{ kA}$ 8/20 µs curve  3 or 4-pole $I_n = 100 \text{ kA}$ 8/20 µs curve	Protection for permanent installations (electricity distribution etc.)
fine protection	D-arrester	class III	$U_{oc} = 20 \text{ kV max.}$ $I_n = 10 \text{ kA max.}$ hybrid generator	Protection for devices (sockets etc.)

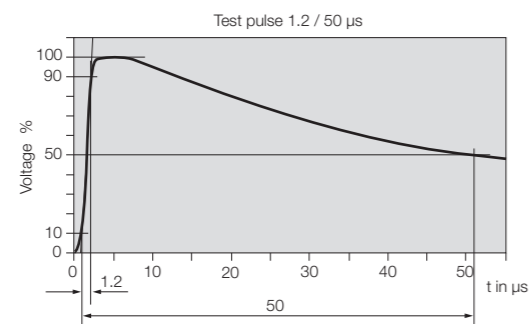
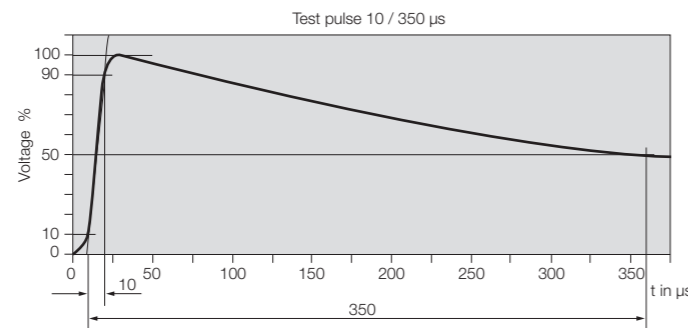
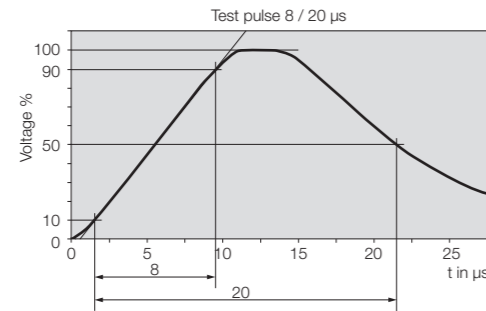

# Components for Surge protection

There is no ideal component that can fulfil all the technical requirements of surge protection equally effectively. Instead, we use a variety of components whose different physical methods of operation complement each other; these possess distinct protective effects. Super-fast reaction time, high current-carrying capacity, low residual voltage and long service life cannot be found in one single component.

In practice we use three principal components:

1. **sparkover gaps**
2. **varistors**
3. **suppression diodes**

Therefore, to optimise the surge protection, carefully matched groups of these components are often combined in one protective module.

#### 4. **Combination circuits**

#### 1. **Sparkover gaps**



**Pulse form shape without GDT**

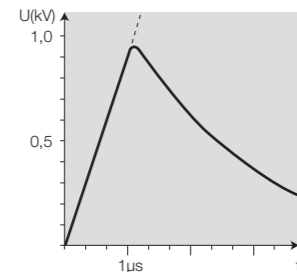

**Pulse form shape with GDT**

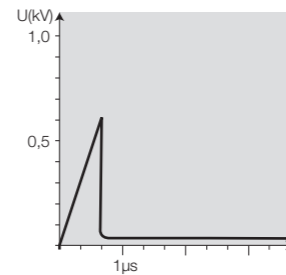

The name says it all. High voltages are discharged to earth via a spark gap (e.g. gas discharge tube) that has been fired.

The discharge capacity of sparkover gaps is very high – up to 100 kA depending on type.

Gas sparkover gaps are incorporated in insulating glass or ceramic (aluminium oxide) housings. The electrodes of the sparkover gap are made from a special alloy and placed in housings which are vacuum sealed and filled with a noble gas such as argon or neon. They are aligned with respect to shape and clearance distance, so that the applied voltage produces a distribution of field strengths. This results in a fairly precise voltage value for the complete ignition of the spark gap. The housings are vacuum-tight and filled with an inert gas such as argon or neon. The spark gap has a bipolar function. The ignition voltage value, however, is dependent on the steepness of the applied surge voltage.

The ignition characteristic curve for gas-filled spark gaps reveals that the ignition voltages increase for those surge voltages which climb more steeply. The consequence is that, for very steep surge voltages, the ignition voltage (that is, the protection level) is relatively high and can be well in excess of the rated voltage for the spark gap (approx. 600–800 V). The problematic quenching behaviour of the fired sparkover gap can be a disadvantage. The arc has a very low voltage and is only extinguished when the value drops below this. Therefore, when designing the geometry of a sparkover gap, care is taken to ensure that – through long distances and also through cooling – the voltage of the arc remains as high as possible and so is quenched relatively quickly. Nevertheless, a longer follow current can ensue. This can draw its energy, in addition, from the incoming supply of the circuit to be protected. One effective solution is to wire a sparkover gap and a fast-acting fusible link in series.

## 2. Varistors

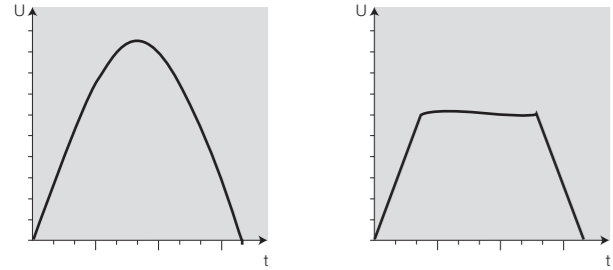

The varistors used with surge protection (MOV-Metal Oxide Varistors) have resistance which depends on the voltage. This is implemented with metal-oxide (zinc-oxide) discs. There is a low-ohm resistance in the range above the rated voltage. The surge voltage is limited since a current flows through the varistor. The varistor works bi-directionally.

Depending on the type, varistors have either a middle or high discharging capacity. It is in the range from 40 kA to 80 kA. The response time is less than 25 ns. However there are also disadvantages when using varistors. Two factors that must be taken into account are the relatively high capacitance and the aging characteristics.

Leakage currents occur over time, depending on the frequency of the triggering, because individual resistance elements break down. This can cause temperature rise or even destroy them completely.

The high capacitance of varistors causes problems in circuits with high frequencies. Attenuation of the signals must be reckoned with for frequencies above about 100 kHz. Therefore, varistors are not recommended for use in data transmission systems.

## 3. Suppression diodes

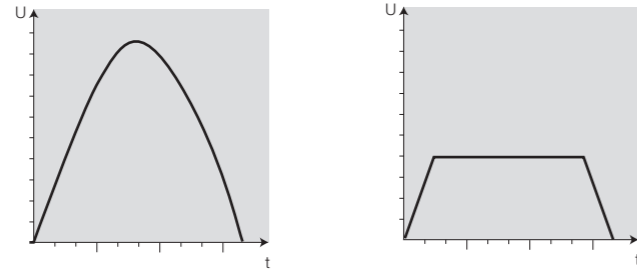

Suppressor diodes function in a similar fashion as Zener diodes. There are uni-directional and bi-directional versions. Uni-directional suppressor diodes are often used in DC circuits. Compared to standard Zener diodes, suppressor diodes have a higher current-carrying capacity and are significantly quicker. At a certain breakdown voltage level, they become conductive very quickly. They therefore discharge the surge voltage. However their current-carrying capacity is not very high. It is only a few hundred amps. Instead, they feature a very quick reaction time which lies in the picosecond range. Unfortunately, suppression diodes possess a significant inherent capacitance. Therefore, like with varistors, their possible attenuation effect on high frequencies must be taken into account.

## 4. Combination circuits

Combining the components described above results in surge fine protection products that can match individual requirements.

If a voltage pulse reaches the input of such a combination circuit, then the gas discharge tube is fired and discharges high current. The residual pulse is attenuated by a downstream inductance and subsequently received and limited by the varistor and/or suppression diode. If the gas discharge tube is not triggered, i.e. in the case of a slower voltage rise, then the pulse is discharged by the varistor or the suppression diode alone.

The sequence of the individual components results in an increasing response sensitivity towards the output.

An interference voltage with a rise of  $1 \text{ kV}/\mu\text{s}$  and a peak value of  $10 \text{ kV}$  at the input is limited by a gas-filled surge arrester to approx.  $600\text{--}700 \text{ V}$ . The second stage, decoupled from the first by means of an inductance, suppresses this value to approx.  $100 \text{ V}$ . This voltage pulse is then reduced to approx.  $35 \text{ V}$  (in a  $24 \text{ V}$  protective combination) by the suppression diode.

Therefore, the downstream electronics need only be able to cope with a voltage pulse of approx.  $1.5 \times U_B$ .

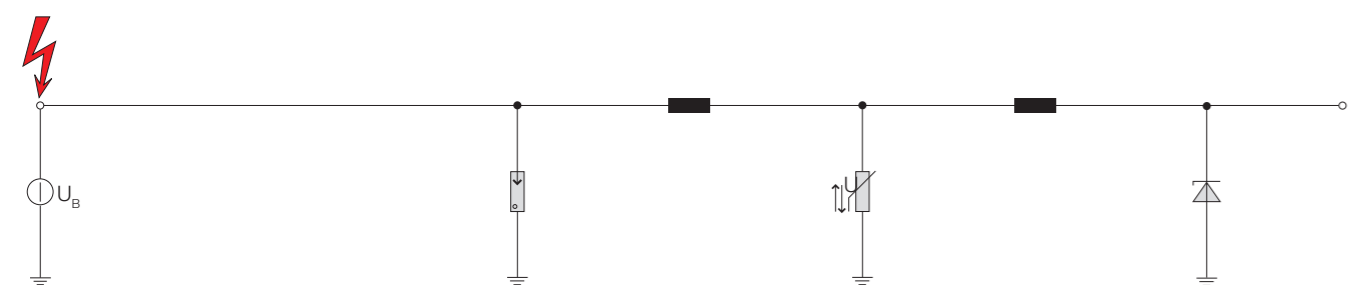
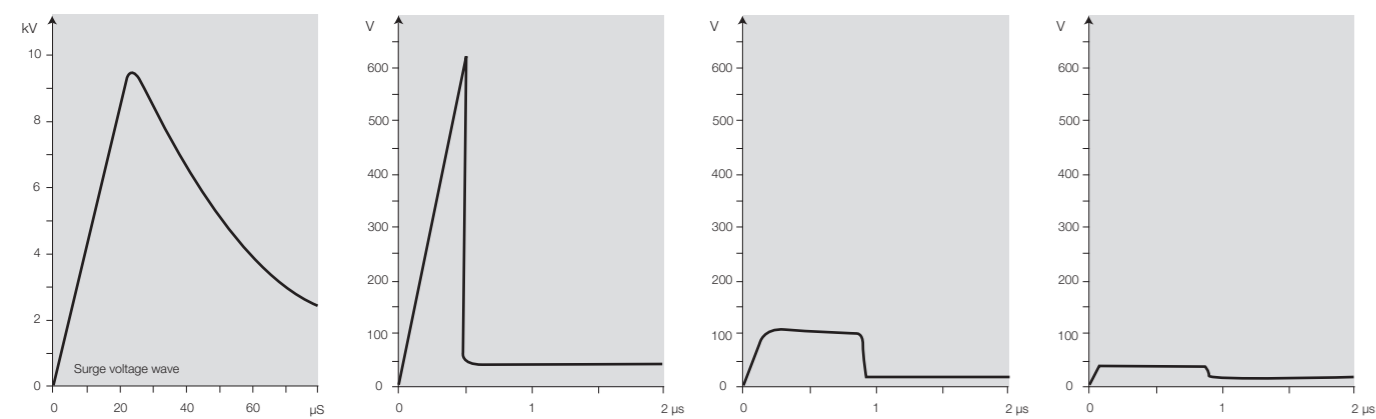





## Lightning protection classes

I

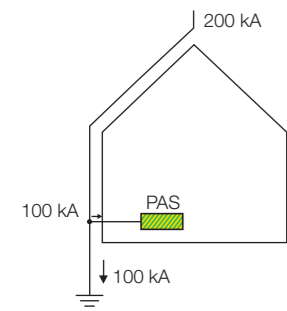

## Lightning protection class I

Lightning protection class I covers a pulse of 200 kA. This pertains to external lightning protection facilities. Half of this pulse is conducted to the earth and the other half is conducted to that section of the facility that is conductive.

If only a four-wire system is available, then a current of 25 kA is distributed to each wire. For a five-wire system, that would correspond to 20 kA.

This lightning protection class covers multiple areas, including: petrochemical facilities (Ex-zones) and explosive material depots.

II

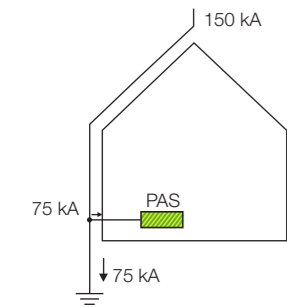

## Lightning protection class II

Lightning protection class II covers a pulse of 150 kA. This pertains to external lightning protection facilities. Half of this pulse is conducted to the earth and the other half is conducted to that section of the facility that is conductive.

If only a four-wire system is available, then a current of 19 kA is distributed to each wire. For a five-wire system, that would correspond to 15 kA.

This lightning protection class covers multiple areas, including: parts of hospitals, shipping warehouses and telecommunication towers.

III/IV

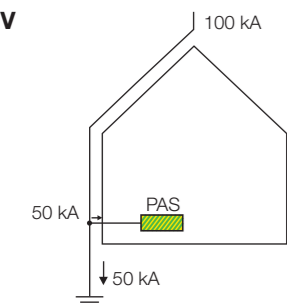

## Lightning protection class III/IV

Lightning protection class III covers a pulse of 100 kA. This pertains to external lightning protection facilities. Half of this pulse is conducted to the earth and the other half is conducted to that section of the facility that is conductive.

If only a four-wire system is available, then a current of 12.5 kA is distributed to each wire. For a five-wire system, that calculates to 10 kA. The 12.5 kA value is also used here.

About 80% of all applications are covered by lightning protection class III. This includes houses, home, administrative buildings and industrial facilities.

# Network forms to DIN VDE 0100 part 300 (DIN 57100 part 310)

The letters describe the earthing conditions

1st letter Earthing at current source	2nd letter Earthing of exposed conductive parts of electrical installation	3rd letter Routing of N and PE conductor (only applies to TN systems)
<b>T-</b> Direct earthing of current source (of transformer)	<b>T-</b> Exposed conductive parts of electrical installation are earthed directly	<b>C-</b> "Combined" N conductor and PE conductor are routed together as PEN conductor from current source into electrical installation
<b>I-</b> Insulated structure of current source	<b>N-</b> Exposed conductive parts of electrical installation are connected to earth of current source	<b>S-</b> "Separate" N conductor and PE conductor are routed separately from current source to exposed conductive parts of electrical installation

### Four-conductor systems:

Still valid according to VDE but unfavourable for information technology systems from the point of view of EMC (VDE 0100 pt 444 / pt 540 pt 2).

#### TN-C-System ("classic earthing")

Neutral conductor and protective earth conductor functions are combined throughout the network in a single conductor, the PEN conductor.

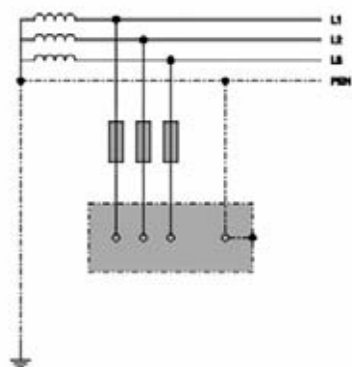

#### TN-C-S-System ("modern earthing")

Neutral conductor, PEN conductor and equipotential bonding system are connected once at the main distribution board or after the incoming supply to the building. Therefore, a TN-C system becomes a TN-S system (TN-C-S system) from this point onwards.

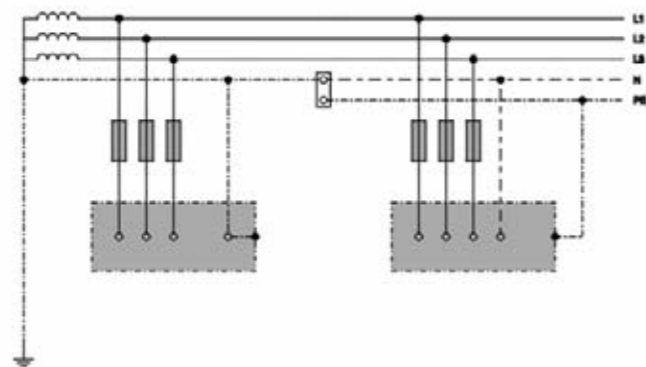



**Five-conductor systems:**

The neutral point of the supply source is earthed (N and PE). Both conductors must be laid separately and insulated from the incoming supply onwards. In these systems the PE (protective earth conductor) does not carry any operating current but instead only discharge currents.

**TN-S systems**

Neutral conductor and protective earth conductor are separated throughout the network.

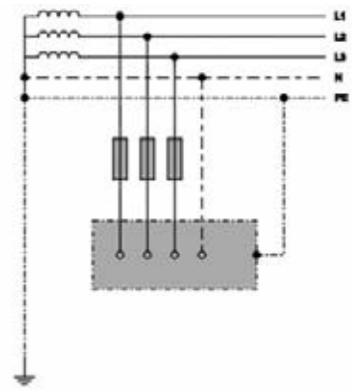

**TT systems**

One point is earthed directly (operational earth). The exposed conductive parts of the electrical installation are connected to earth lines separate from the operational earth.

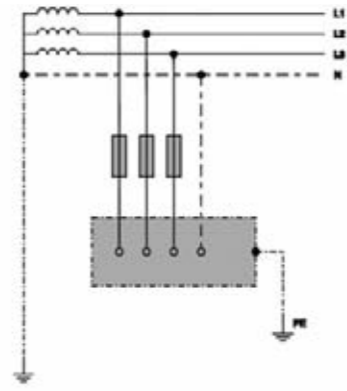

**Special system:**

Used, for example, in medical applications

**IT systems**

There is no direct connection between active conductors and earthed parts. The exposed conductive parts of the electrical installation are earthed.

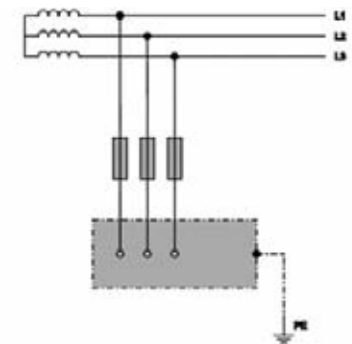

# Applications, installation positions: Application Office building

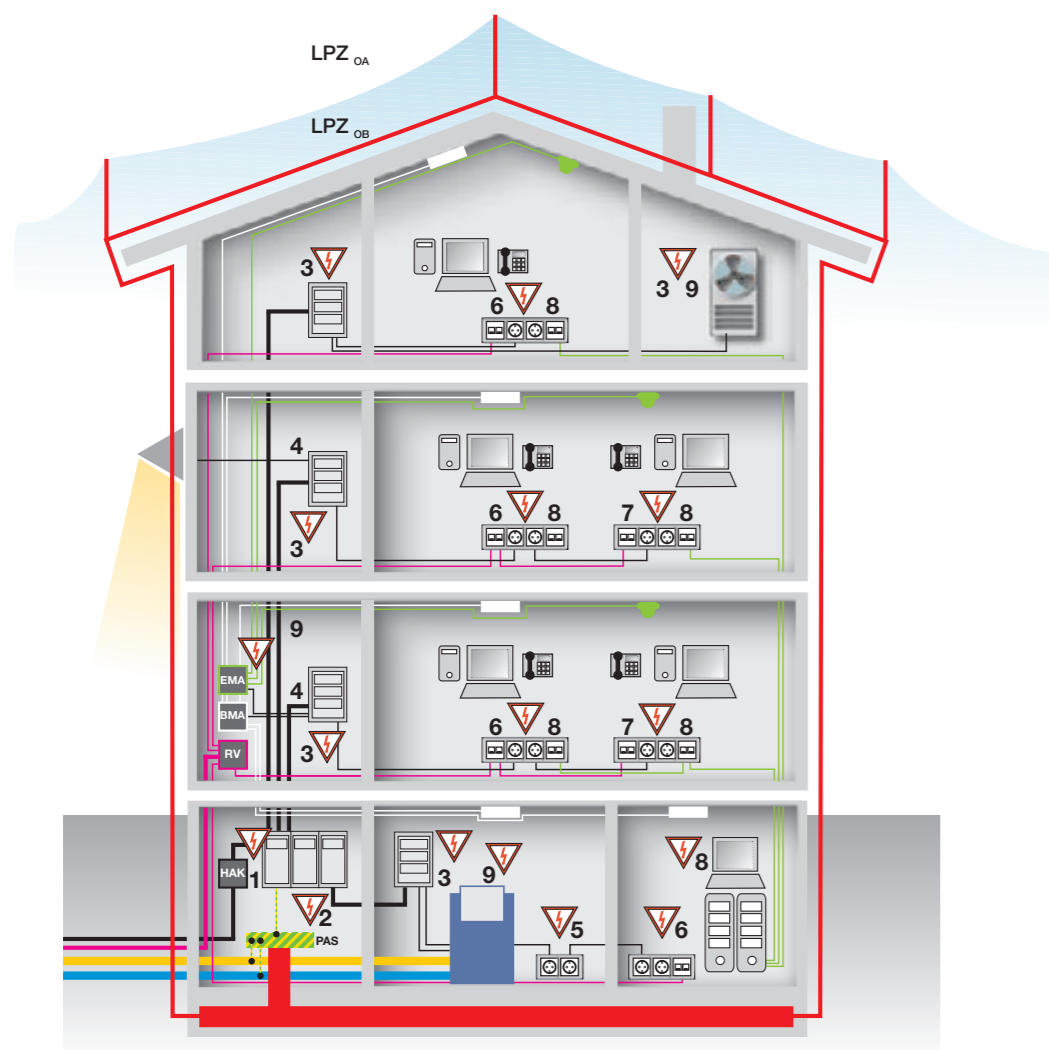

### Power (low-voltage supply)

- 1 Class I Arresters with sparkover gaps, PU 1 TSG / PU 1 TSG+
- 2 Class I Arresters with high-power varistors, PU BC series, PU I series
- 3 Class II Arresters with varistors, PU II series
- 4 Class III Arresters for installing in subdistribution boards, PU III series
- 5 Class III Arresters in the form of plug-in surge protectors, PU D ZS

### Data

- 8 Surge protection for data lines, e.g. Ethernet CAT.5

### Power and data

- 6 Class III Arresters in the form of plug-in surge protectors with protection for **analogue** telephone lines, PU D ZS
- 7 Class III Arresters in the form of plug-in surge protectors with protection for **digital** telephone lines, PU D ZS

### Instrumentation and control equipment

- 9 Surge protection for instrumentation and control circuits, e.g. MCZ OVP series



# Applications, installation positions: Application Industrial building

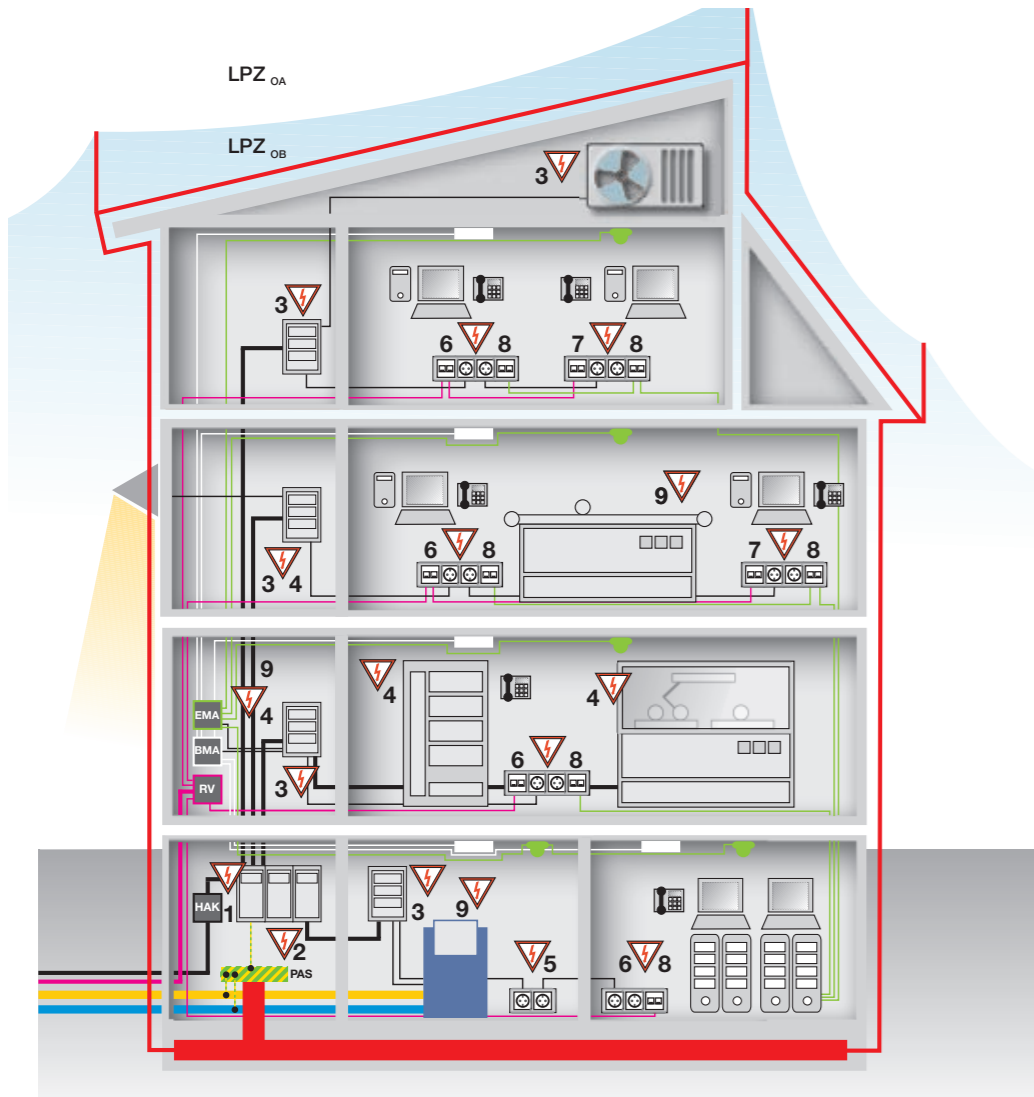

**Standards**

**IEC 61643-1** Ed.2 2005-03, SPDs connected to low-voltage power distribution systems. Class I, Class II and Class III products are tested in accordance with this standard.

**IEC/EN 62305-1 until 4**, - Protection against lightning.

This lightning protection standard defines everything to do with internal and external lightning protection. It includes four sections:

- "Protection against Lightning – Part 1: General principles"
- "Protection against Lightning – Part 2: Risk management: assessing the damage risk for buildings and structures"
- "Protection against Lightning – Part 3: Physical damage to structures and life hazared"
- "Protection against Lightning – Part 4: Electrical and electronic systems within structures"

Regulations for installation

**IEC 60364-5-53: 2002-6**, Electrical installations of buildings – Part 5-53. Standard for the installation of low-voltage facilities.

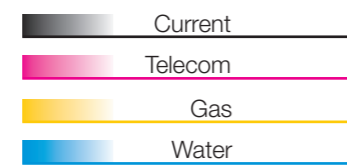

**LPZ OA**  
Unprotected area outside of the building. Direct lightning strike; no shielding against electro- magnetic interference.

**LPZ OB**  
Area protected by lightning protection system. No shielding against LEMP.



## General installation advices

Many details have to be taken into account during the installation of surge protection and the electrical system in order to achieve optimum protection.

### Arrangement and subdivision of electrical panel

Steel cabinets possess good magnetic shielding properties. The following points should be taken into consideration during the installation:

- Avoid unnecessarily long lines (particularly lines with a high volume of data traffic).
- Route sensitive signalling lines separately from lines with a high interference potential.
- Route shielded lines directly to the equipment and connect the shielding there (do not connect via additional terminal in switching cabinet).
- Classify equipment in groups with different sensitivities and place these together.

### Place of installation

The surge protection devices should be mounted where the lines and cables enter the cabinet. This is the lowest mounting rail directly above the cable entries. This prevents interference being coupled within the cabinet; interference is discharged right at the entry to the cabinet. When using shielded lines, these can be connected at this point by using Weidmüller clamp straps.

### Routing the lines

Signalling lines should be laid within the system/cabinet over the shortest route to the surge protection and then continue to the connected equipment. Protected and unprotected lines should be routed separately. The earth line should be regarded as an unprotected line. Metal partitions can be used along cable routes or in cable ducts to achieve this separation. If signalling lines are laid parallel to power lines, a clearance of min. 500 mm must be maintained.

### Earthing of products and connected products

All surge protection devices include an earth connection terminal. The earth line of the associated equipotential bonding strip must be connected to this point. The cross-section of this earth line must be as large as possible and the length of the line kept as short as possible; every centimetre of line increases the residual voltage of the surge protection device. In addition to the

earth connection terminal, the MCZ OVP module also has a mounting rail contact for earthing directly to the TS 35 rail. The mounting rail should be mounted on an earthed metal back plate in order to achieve optimum earthing. The earth connection terminal of the MCZ OVP should be connected to the equipotential bonding every 600 mm in order to achieve a satisfactory protection level.

### Fuse protection

Surge protection devices for instrumentation and control systems frequently operate with a decoupling between the components. This decoupling is achieved with inductors or resistors. Decoupling, besides the types and routes of lines, compels us to employ fuse protection at the maximum level of the rated current for the surge protection devices. Fuse protection for the PU series on the power feed side must be designed in accordance with DIN VDE 0298 part 4 (conductor cross-section, number and type of conductors as well as type of installation). This information is given on a leaflet included with the respective PU module.

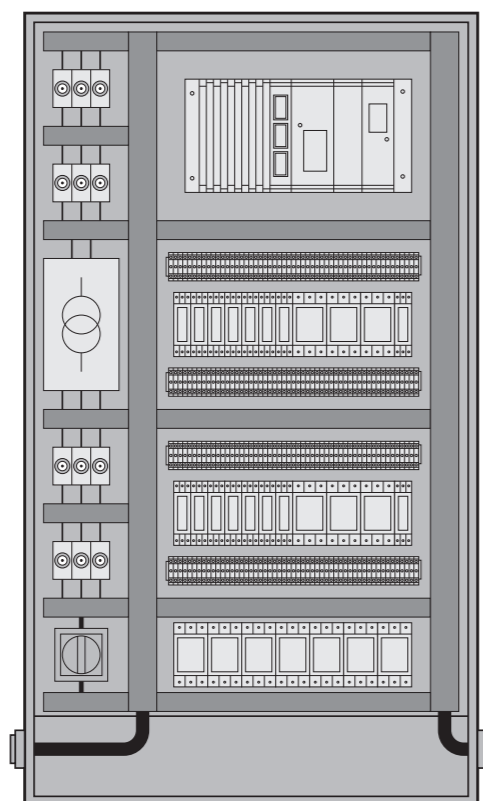

# Surge protection standards and regulations

In the case of national and international standards and specifications on the same subject, the document with the widest scope takes precedence (e.g. international "IEC", European "CENELEC" or "CNC", national (Germany) "DIN VDE" or (Austria) "ÖVE").

IEC	EN	VDE	others	
	EN 60728-11			Cables distribution systems for television and sound signals – Part 11: Safety requirements
IEC 60364-5-53	HD 60364-5-53	VDE 0100-534		Electrical installations of buildings – Part 5-53: Selection and erection of electrical equipment – Isolation, switching and control – Part: 534: Surge protection device
IEC 60364-5-54	HD 60364-5-54	VDE 0100-540		Electrical installations of buildings – Part 5-54: Selection and erection of electrical equipment – Earthing arrangements, protective conductors and protective bonding conductors
IEC 60664-1	EN 60664-1	VDE 0110-1		Insulation coordination for equipment within low-voltage systems – Part 1: Principles, requirements and tests
IEC 61241-14	EN 61241-14	VDE 0165 part 2		Electrical apparatus for use in the presence of combustible dust – Part 14: Selection and installation
IEC 60079-11	EN 60079-11	VDE 0170 part 7		Explosive atmospheres – Part 11: Equipment protection by intrinsic safety "I"
IEC 62305-1	EN 62305-1	VDE 0185-305-1		Protection against lightning – Part 1: General principles
IEC 62305-2	EN 62305-2	VDE 0185-305-2		Protection against lightning – Part 2: Risk management
IEC 62305-3	EN 62305-3	VDE 0185-305-3		Protection against lightning – Part 3: Physical damage to structures and life hazard
IEC 62305-4	EN 62305-4	VDE 0185-305-4		Protection against lightning – Part 4: Electrical and electronic systems within structures
IEC 60529	EN 60 529	VDE 0470-1		Degrees of protection provided by enclosures (IP code)
IEC 60099-1 DIN IEC 37-197-CDV	EN 60099-1	VDE 0675, part 1		Surge arresters – Part 1: non-linear resistor type gapped surge arresters for A.C. systems
IEC 60099-4	EN 60099-4	VDE 0675, part 4		Surge arresters – Part 4: Metal-oxide surge arresters without gaps for A.C. systems
IEC 60099-5	EN 60099-5	VDE 0675, part 5		Surge arresters – Part 5: Selection and application recommendations
IEC 61643-1	EN 61643-11	VDE 0675-6-11	ÖVE SN 60 part 1+4	Low-voltage surge protective devices – Part 11: Surge protective devices connected to low-voltage power systems – Requirements and tests
		VDE 845, part 1		Protection of telecommunication systems against lightning, electrostatic discharges and over-voltages from electric power installations; Provisions against over-voltages
IEC 60038	HD472	VDE 0175		IEC standard voltages
			KTA 2206, 06.92	Lightning protection standard for nuclear power plants
			VDE publication 44	Lightning protection systms, expanations to DIN 57185/VDF 01 85, published by VDE
			DIN-VDE publication	Publication No. 519; Lightning protection systems 1, external lightning protection, published by VDE
			DKE publication No 520	Publication No. 520; Lightning protection systems 2, internal lightning protection, published by VDE
			ÖVE 8001 §18	Protection against lightning

The above list is not exhaustive.



# Surge protection concept

A

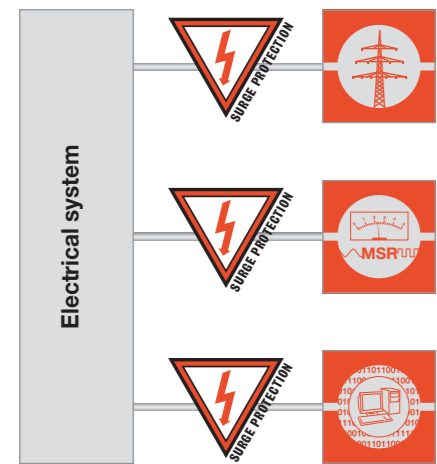

effective surge protection is the presence of properly functioning equipotential bonding to DIN VDE 0100 part 540 in a series, or better still, star or grid arrangement.

DIN VDE 0110 (insulation coordination) divides overvoltage protection for power supplies and power distribution into the following three areas:

## 1. Power supply

The surge voltage strength of the insulation is 6 kV from the incoming supply to the building – by means of underground cables or overhead lines – right up to the main distribution board (backup fuse and meter cupboard). Owing to the lightning protection zoning concept and the physical circumstances, high-energy overvoltages have to be discharged here.



Surge currents exceeding 200 kA can be generated by cloud-to-ground but also cloud-to-cloud lightning discharges.

As a rule, 50% of the current is discharged via the lightning protection system and the remaining 50% is coupled into the conductors and conductive parts in the building and distributed uniformly. The closer a conductor is to the lightning protection system, the greater is the launched voltage (which can exceed 100 kV). The pulse duration can be up to 0.5 ms. These powerful interference pulses are discharged to earth directly at the incoming supply or main distribution board by class I lightning arresters and limited to voltages below 6 kV. Power follow currents and backup fuse values are just some of the aspects that need to be taken into account here.

Depending on the local circumstances and the discharge currents to be expected, sparkover gaps or varistor surge arresters are used, taking into account the type of network.

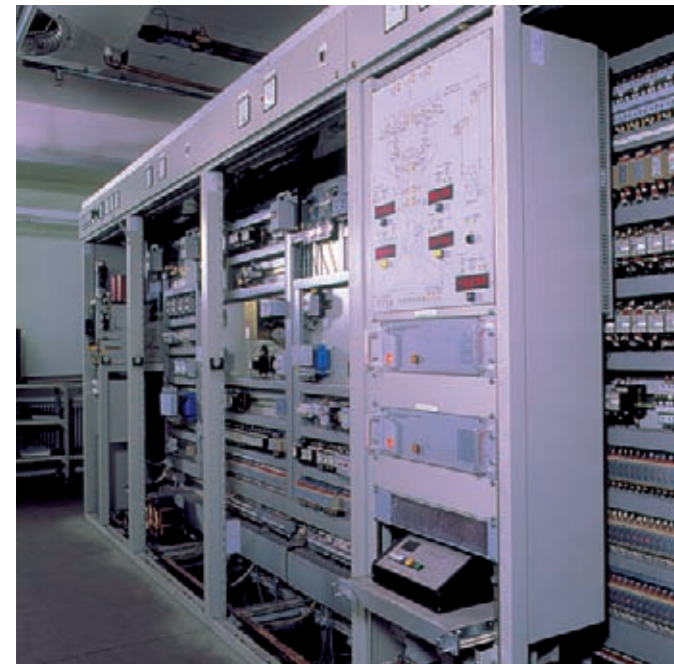



If a lightning protection system has been installed, or the power supply is via overhead lines, or buildings or plants are spread over a wide area and individual buildings are sited on elevated ground or open areas, high-capacity class I arresters should always be employed.

## 2. Subdistribution

The surge voltage strength of the insulation is 4 kV from the main distribution board up to and including subdistribution boards. Owing to the coordinated use of arresters, class II surge arresters are used here and, if necessary, decoupled from class I arresters by means of coils. The use of decoupling coils is only necessary when the class I arresters consist of one sparkover gap and the length of the line between the class I and class II arresters is less than 10 m. It is not necessary to decouple Weidmüller class I and class II arresters. The pulse currents that occur here are no longer that high because most of the energy has already been absorbed by the class I arresters. Nevertheless, the line impedances give rise to high interference voltages which must be limited to less than 4 kV by the class II arresters. Class II arresters based on varistors are normally installed in the subdistribution board before the residual-current circuit-breakers.

## 3. Terminals, consumers, sockets

The surge voltage strength of the insulation is 2.5 kV from the subdistribution board to the electrical consumer. Surge arresters in Class III are used for this purpose. Depending on the application, they can be used as protective components or in composite switching together with gas discharge tubes, varistors, suppressor diodes and decoupling elements. These arresters are best installed directly before the device to be protected. This can be in a socket or trailing socket (on extension lead) but also in the terminal or junction box of the device itself.

To protect against permanent interference such as “ripples” or “noise” caused by other systems, additional filter circuits are available for the voltage supplies to devices. The insulation of the electrical consumer itself has a surge voltage strength of 1.5 kV.

### Principle for selecting arresters according to IEC 664 DIN VDE 0110 part 1

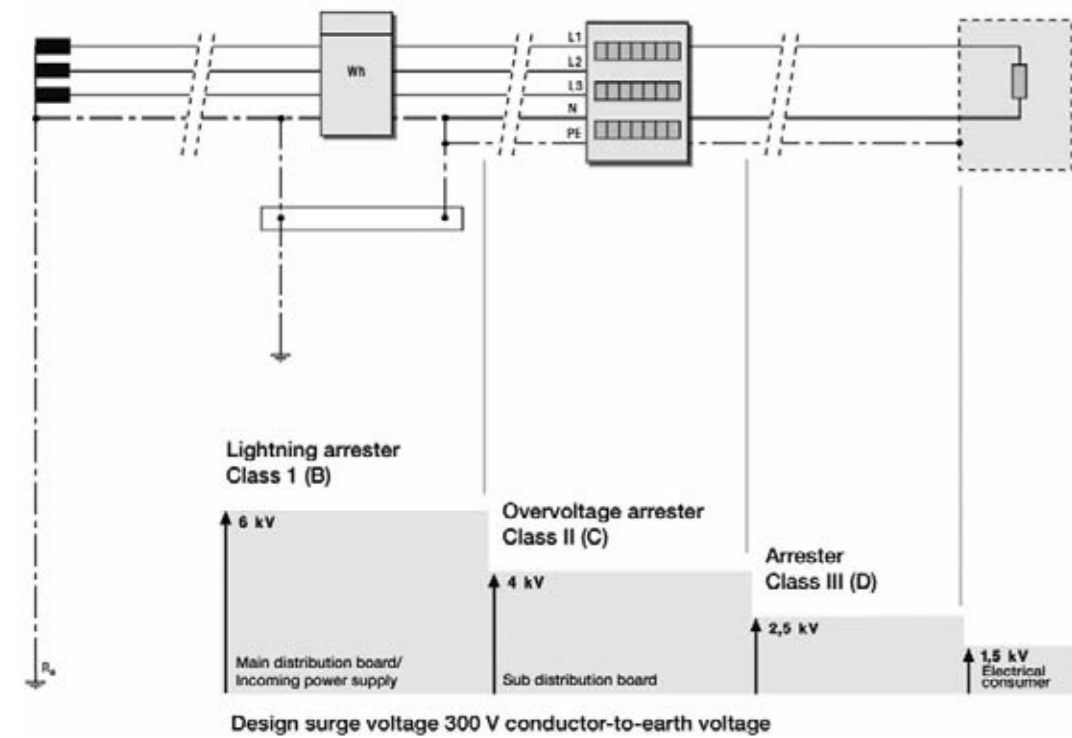





# Surge protection Innovations 2010/2011

<b>for instrumentation and control equipment</b>	VSPC – Overview	B.2
	VARITECTOR SPC – Choice of device depending on the interface	B.7
	VARITECTOR SPC	B.8
	VARITECTOR SPC EX	B.36
	VARITECTOR SSC 6AN	B.48
	VARITECTOR SSC 4AN	B.72
<b>for low-voltage supplies</b>	PU II 750 V	B.82
	PU I 3+1 280 V	B.85
	PU I TSG+	B.86



# VARITECTOR SPC

## Pluggable surge protection for the measurement and control industry VARITECTOR SPC

Weidmüller's VARITECTOR SPC pluggable surge protection is remarkable for its combination of extremely high protective functionality and compact dimensions. It is suited for use in measurement and control circuits.

The size is made possible by the selection of INSTA dimensions, with a width of 17.8 mm (1TE).

Two versions are available:

- VSPC: a surge protector with no monitoring function
- VSPC R: a surge protector with monitoring function

The base components are plugged in to form a direct earthing contact via the mounting rail. Thus you save time during the connection. The VARITECTOR SPC series is optimally designed for compact installation locations in process automation, industrial automation or building automation. The two-stage surge-protection base components are equipped with gas discharge tubes, suppressor diodes (TVS) and decoupling components. Individual protective components (such as gas-filled spark gaps, varistors and suppressor diodes) supplement this product line. IEC 62305 requires that a periodic inspection of surge protection products be conducted. The functionality of all VARITECTOR SPC modules can be tested using testing equipment (such as the V-TEST Basic) that is available separately. The VARITECTOR SPC R modules also feature an internal monitoring function. The green LED signals when the protection function is ready. The red LED signals an error. VARITECTOR SPC Up to ten modules can be wired together in

series. The modules alert an evaluative module (the VSPC CONTROL UNIT) in the event of an error. VARITECTOR SPC-series surge protection is available with rated voltages of 5 V, 12 V, 24 V, 48 V and 60 V. The product's voltage level is colour-coded on the pluggable arrester. An earthing contact is established by snapping onto an earthed TS35 rail. The TS35 must be earthed in order to ensure safe power discharging via the terminals of up to 20 kA (8/20 µs) and 2.5 kA (10/350 µs). The rail must be screwed onto the earthed mounting plate for reasons of EMC. In order to optimize the protective function, a PE-contact connection should be made over the VSPC module every 60 cm for equipotential bonding. The pluggable protective element can be pulled out during operations without interrupting the measurement circuit. A testing instrument, available as a Weidmüller accessory, allows you to test the protective element in compliance with the IEC 62305-3 directive. The accessory also includes a simple mechanism for applying the wire shield.



## Overview of model types

A VARITECTOR SPC (VSPC) consists of a **pluggable component** and a **separate base component (VSPC BASE)**.

### Explanation of terms:

CL = current loop / analogue signals

SL = symmetric loop - for binary signals

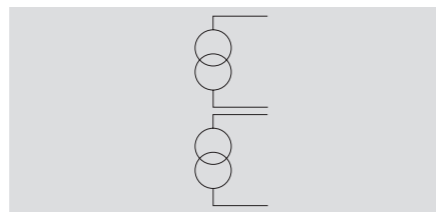
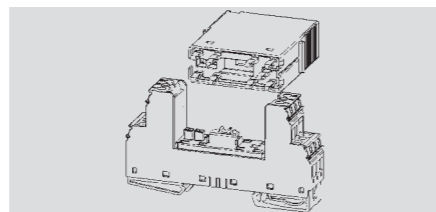

**VSPC 2CL** (CL = current loop) is a two-stage protective combination with a gas discharge tube and a suppressor diode located between the current paths. This VSPC 2CL limits the surge voltage within **two analogue signal circuits** (such as for current loops). This pluggable component can be inserted into the base (VSPC BASE 2CL). The base (VSPC BASE FG 2CL) is used when working with signal circuits which are not earthed. The VSPC 2CL HF is used in order to avoid influencing high-frequency signal circuits (this also includes the VSPC RS485 and the VSPC UK0). This protective combination is also inserted into the base mentioned above.

### Monitoring function

The **VSPC 2CL R** products feature monitor and alert functions. Despite the alert function, there are still two channels available for current loops in a single

housing. The special VSPC BASE 2CL R and VSPC BASE 2CL FG R bases transfer the alert function to a 2-pole screw/plug-in connection in the bases and to the VSPC CONTROL UNIT.

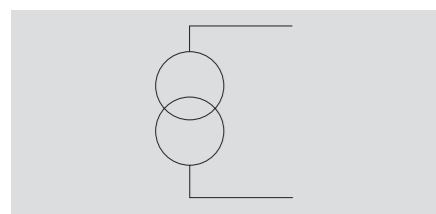

The **VSPC 1CL** is a two-stage protective combination with a gas discharge tube and a suppressor diode located between the current paths. This VSPC 1CL limits the surge voltage within **one analogue signal circuits** (such as for current loops). This pluggable component can be inserted into the base (VSPC BASE 1CL). The base (VSPC BASE FG 1CL) is used when working with signal circuits which are not earthed.

**Monitoring function**

The **VSPC 1CL R** products feature monitor and alert functions. All channels remain despite the alert function. The special VSPC BASE 1CL R and VSPC BASE 1CL FG R bases transfer the alert function to a 2-pole screw/plug-in connection in the bases and to the VSPC CONTROL UNIT.

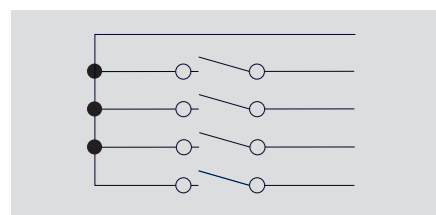

The **VSPC 4SL** is a two-stage protective combination with a gas discharge tube and a suppressor diode from the current path to the PE. This VSPC 4SL limits the surge voltage within **four binary signal**

**circuits** (such as for alert contacts). This pluggable component can be inserted into the base (VSPC BASE 4SL). The base (VSPC BASE FG 4CL) is used when working with signal circuits which are not earthed.

**Monitoring function**

The **VSPC 4SL R** products feature monitor and alert functions. Despite the alert function, there are still channels available for the four binary signal circuits in a single housing. The special VSPC BASE 4SL R base transfers the alert function to a 2-pole screw/plug-in connection in the base and to the VSPC CONTROL UNIT.

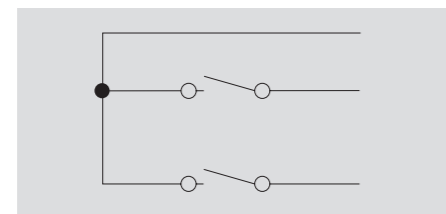

The **VSPC 2SL** is a two-stage protective combination with a gas discharge tube and a suppressor diode from the current path to the PE. This VSPC 2SL limits the surge voltage within **two binary signal circuits** (such as for alert contacts). This pluggable component can be inserted into the base (VSPC BASE 2SL). The base (VSPC BASE 2CL FG) is used when working with signal circuits which are not earthed.

**Monitoring function**

The **VSPC 2SL R** products feature monitor and alert functions. Despite the alert function, there are still channels available for the two binary signal circuits in a single housing. The special VSPC BASE 2SL R base transfers the alert function to a 2-pole screw/plug-in connection in the base and to the VSPC CONTROL UNIT.

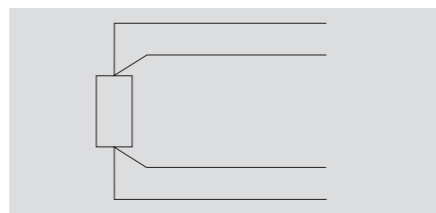

The **VSPC 3/4WIRE** is a two-stage protective combination with a gas discharge tube and a suppressor diode from the current path to the GND. This VSPC 3/4WIRE limits the surge voltage within four temperature-measurement circuits (such as for DMS or PT100/100 sensors). For non-earthed measurement circuits, we recommend using the base (VSPC BASE FG 4CL).

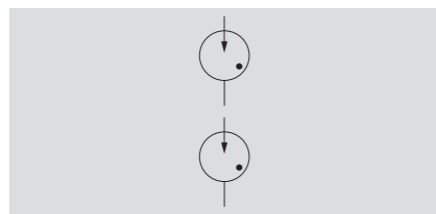

**VSPC MOV 2CH , VSPC TAZ 2CH und VSPC GDT 2CH**

Four cables can be protected with the 2CH modules. By wiring the connections differently, either two no-voltage signal lines or four binary signal lines can be protected. Two three-pole gas discharge tubes (GDTs) are used for the VSPC GDT 2CH. This universal protective circuitry limits the voltage between the signal lines and also between each signal line and the PE.

B



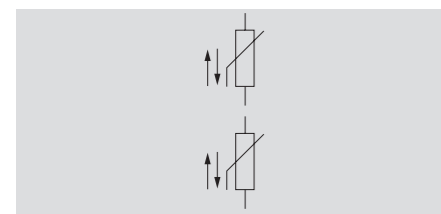
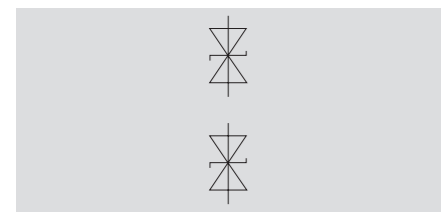

The VSPC MOV 2CH and TAZ 2CH offer one-stage protection with a varistor (MOV) or suppressor diode (TAZ or TVS) between the current paths. This makes it possible to protect a no-voltage (floating) signal circuit. Two binary signal circuits can also be protected if terminals 1 and 7 are assigned to GND / PE. These VSPC pluggable components are inserted into the base (VSPC BASE 2/4CH). The base (VSPC BASE 2/4CH FG) is used when working with signal circuits which are not earthed..

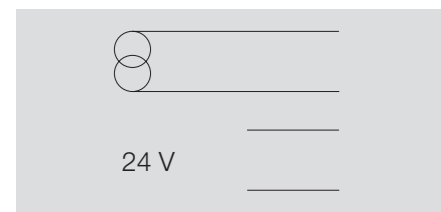

**VSPC 1CL PW (power and signal 1CL)** offers combined protection that is suitable for the 24 VDC power supply and the current loops within a device. This VSPC protects sensors with an additional 24 VDC.

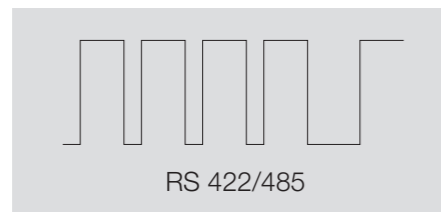

The **VSPC RS485** is a two-stage protective combination with a gas discharge tube and a suppressor diode located between the current paths. This VSPC RS485 limits the surge voltage within **two high-frequency signal circuits**. This pluggable component can be inserted into the base (VSPC BASE 2CL). The base (VSPC BASE FG 2CL) is used when working with signal circuits which are not earthed.

#### Monitoring function

The VSPC RS485 R product features monitoring and alert functions. Despite the alert function, there are still two channels available for current loops in a single housing. The special VSPC BASE 2CL R and VSPC BASE 2CL FG R bases transfer the alert function to a 2-pole screw/plug-in connection in the bases and to the VSPC CONTROL UNIT.

#### Earthing unit and test plug

The earthing unit can be used during installation to short out the connected wires to earth. The earthing unit is swapped out for a VSPC pluggable component before the initial commissioning. The test plug has 2,3-mm sockets. These sockets can be used by a meter to check the connected measurement circuit..

#### Applications

The pluggable INSTA housing was created in compliance with DIN 43880. It consists of a lower section (the VSPC BASE) and a pluggable component (the VSPC). The VSPC BASE is made from black PA6.6 V0. The pluggable component is made from red PA6.6 V0. The temperature range is from -40 °C to + 70 °C. The VSPC series has been tested to comply with IEC 61643-21 04/2008 and EN 61643-21. Modules were tested with categories C1, C2 and C3; with quick-rising edges with up to 300 pulses. Category D1 describes high power testing (10/350 µs), so that the VSPC can be used according to IEC 62305-4. The base and pluggable components are colour coded according to the voltage level. This makes installation easier.

#### Colour coding

The pluggable components transfer their coding to the base element when they are plugged in for the first time. The voltage levels are also labelled with coloured Dekafix markers applied to the VSPC pluggable component. This gives you a better overview within the electrical cabinet.

Voltage level	Colour
≤ 12 V	green
24 V Binary	blue
24 V Analogue	yellow
48 V	red
≥ 60 V	violet
Special function	white

**Test possibility / V-TEST**

Because the modules are pluggable, it is possible to test the VSPC visually or by using a V-TEST BASIC testing device. The VSPC can be easily tested; the user needs only to insert the VSPC pluggable component into the V-TEST BASIC. The result is then shown on the display. The VSPC R modules also feature an internal monitoring function for the arrester. An error is displayed at the defective module. The VSPC CONTROL UNIT can then transfer an alert to the control room.

**Reoccurring tests / V-TEST**

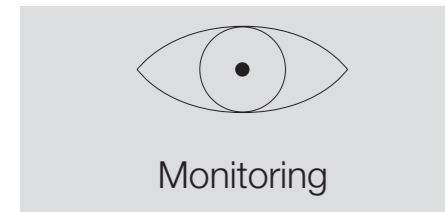

The IEC 62305-3 requires testing and maintenance for lightning protection systems. This includes the testing of the arresters used in the system.

Class of protection	Interval for complete testing	Interval for visual inspection
I	2 years	1 year
II	4 years	2 years
III/IV	6 years	3 years

**Caution!** These periodic inspections may be extended with stricter requirements pertaining to special applications or regions.

**Remote error diagnostics**

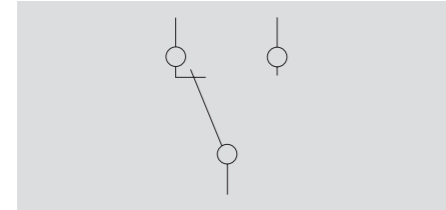

When the VSPC module labelled "R" is inserted into the corresponding "R" base component, it is then possible to use the outage alert function via a two-pole plug. This screw/plug-in connection has a clamping range from 0.5 to 1.5 mm<sup>2</sup>. The wire stripping length is 6 to 6.5 mm. A screwdriver with a 2-mm blade width is used to turn the screw. The VSPC Rs are connected in series to the VSPC CONTROL UNIT evaluative module. Up to ten VSPC Rs can be connected in series to the VSPC CONTROL UNIT. The evaluative module is supplied with 24 VDC. It is then responsible for the switching and for the voltage supply to the VSPC modules. A no-voltage (floating) CO contact can then be used to alert in the event of an outage. The error is also displayed directly on the module when the LED changes colour from green to red. An automatic reset is carried out by the VSPC CONTROL UNIT within one minute after the failed VSPC pluggable component is replaced.

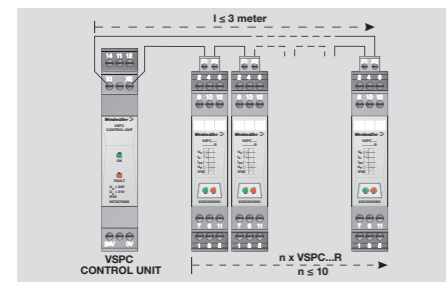

**Installation**

The VSPC series is appropriate for protecting signal circuits. In order to achieve a complete protective strategy for the facility, the power feed must be protected against Class-II surge voltages (for example, by using the PU II series). For existing lightning protection facilities, Class-I protection must be used (for example, by using the PU I series). Class-II protection (for example, the PU II) is sufficient when there is no lightning protection facility.

**Fusing**

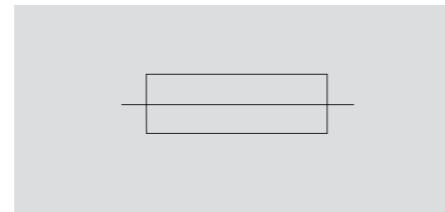

The VSPC surge protection modules are designed so that they are decoupled between the individual protective stages. The following must be observed when providing fuse protection externally:

- Max. rated current
- Deratings curve
- Type of installation
- Application

B





## VSPC – Overview

### Discharge capacity

Testing is conducted using voltage and current pulses according to the IEC 61643-21 standard concerning surge protection in networks which process signals.

Category	Testing pulse	Surge voltage	Surge current	Pulse	Type
C1	Quick-rising edge	0.5 - 2 kV with 1.2/50 µs	0.25 - 1 kA mit 8/20 µs	300	Surge voltage arrester
C2	Quick-rising edge	2 - 10 kV with 1.2/50 µs	1 - 5 kA mit 8/20 µs	10	Surge voltage arrester
C3	Quick-rising edge	≥ 1 kV with 1 kV/µs	10 - 100 A mit 10/10000 µs	300	Surge voltage arrester
D1	High power	≥ 1 kV	0.5 - 2.5 kA mit 10/350 µs	2	Arrester for lightning current and surge voltages

Category C reflects the interference pulses with quick-rising edges and minimized power. Category D uses quick-rising edges and high power to detail the interference pulses. This energy simulates the high-power load that stems from coupled partial lightning currents.

### General technical data

Storage temperature: -40 °C...+80 °C  
Operating temperature: -40 °C...+70 °C  
Air humidity: 5%...96% RH with no condensation  
Material: V0, IP20

Connection: screw connection  
screwdriver blade: 0.6 x 3.5 DIN 5264  
(for example, 0.6x3.5x200, order no. 9010110000)  
rated torque: 0.5 Nm  
max. torque: 0.8 Nm  
stripping length: 7 mm  
solid: 0.5...4 mm<sup>2</sup>  
flexible: 0.5...2.5 mm<sup>2</sup>  
wire-end ferrule with plastic collar:  
0.5...2.5 mm<sup>2</sup>

Remote signalling connection:  
screw connection  
screwdriver blade: 0.4 x 2.0 DIN 5264  
(for example, SD 0.4x2.0x60, order no. 9037160000)  
max. torque: 0.2 Nm  
stripping length: 6...6.5 mm  
solid: 0.5...1.5 mm<sup>2</sup>

### Dimensions

length : 90 mm  
length with remote signalling contact:  
98 mm  
height: 69 mm  
width: 17.8 mm

### Accessories

#### Markers

The VSPC BASE lower section can be labelled with Dekafix-5 markers. The VSPC pluggable modules are colour coded with Dekafix-5 markers according to their rated voltage.

#### Shield connection

EMC SET, order number 1067470000  
The EMC set consists of a connection component with shielding and a cable tie covered with shielding braid. The RT-1 cable tie tool (order number 1296000000) can be used to fasten the cable ties professionally.

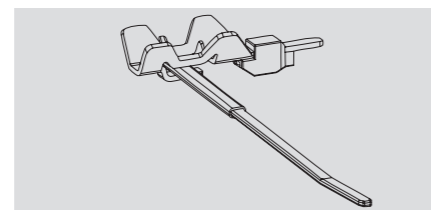

#### V-Test

Testing device for functional tests of the pluggable VSPC, PU II and PU I surge protection.



# VARITECTOR SPC – Choice of device depending on the interface

Interface	Pluggable arrestor	Order No. Arrestor	Order No. Base	Order No. Base floating ground (FG)	Pluggable arrestor with operation message (R)	Order No. Arrestor	Order No. Base	Order No. Base floating ground (FG)
<b>0(4) ... 20 mA</b>	VSPC 2CL 24Vdc 0,5A	8924470000	8924710000	8924270000	VSPC 2CL 24Vdc 0,5A R	8951480000	8951710000	8951720000
<b>0(4) ... 20 mA</b>	VSPC 1CL 24Vdc 0,5A	8924480000	8924730000	8924290000	VSPC 1CL 12Vdc 0,5A R	8951540000	8951730000	8951740000
<b>0 ... 10 V</b>	VSPC 2CL 24Vdc 0,5A	8924470000	8924710000	8924270000	VSPC 2CL 24Vdc 0,5A R	8951480000	8951710000	8951720000
<b>0 ... 10 V</b>	VSPC 1CL 24Vdc 0,5A	892448 0000	8924730000	8924290000	VSPC 1CL 12Vdc 0,5A R	8951540000	8951730000	8951740000
<b>ADSL</b>	VSPC Uko	8924660000	8924710000	8924270000				
<b>ADVANT</b>	VSPC 2CL HF 5Vdc	8924430000	8924710000	8924270000	VSPC 2CL HF 5Vdc R	8951680000	8951710000	8951720000
<b>ARCNET (Plus)</b>	VSPC R485 2ch	8924670000	8924710000	8924270000	VSPC R485 2ch R	8951670000	8951710000	8951720000
<b>ASI</b>	PU III R 48Vdc	8860350000			PU III R 48Vdc	8860350000		
	PU III R 24Vdc	8860360000			PU III R 24Vdc	8860360000		
<b>BITBUS</b>	VSPC 2CL HF 12Vdc	8924460000	8924710000	8924270000	VSPC 2CL 12Vdc 0,5A R	8951470000	8951710000	8951720000
<b>BLN (Building Level Network)</b>	VSPC 2CL HF 12Vdc	8924460000	8924710000	8924270000	VSPC 2CL 12Vdc 0,5A R	8951470000	8951710000	8951720000
<b>Level Network</b>	VSPC 1CL 24Vdc 0,5A	892448 0000	8924730000	8924290000	VSPC 1CL 12Vdc 0,5A R	8951540000	8951730000	8951740000
<b>CAN-Bus</b>	VSPC 2CL HF 12Vdc	8924460000	8924710000	8924270000	VSPC 2CL HF 12Vdc R	8951690000	8951710000	8951720000
<b>C-BUS</b>	VSPC 2CL HF 12Vdc	8924460000	8924710000	8924270000	VSPC 2CL HF 12Vdc R	8951690000	8951710000	8951720000
<b>CC-LINK</b>	VSPC 2CL HF 12Vdc	8924460000	8924710000	8924270000	VSPC 2CL HF 12Vdc R	8951690000	8951710000	8951720000
<b>Data Highway (Plus), DH+</b>	VSPC 2CL HF 12Vdc	8924460000	8924710000	8924270000	VSPC 2CL HF 12Vdc R	8951690000	8951710000	8951720000
<b>Datex-P</b>	VSPC 2CL HF 12Vdc	8924460000	8924710000	8924270000	VSPC 2CL HF 12Vdc R	8951690000	8951710000	8951720000
<b>DeviceNet</b>	VSPC 2CL HF 12Vdc	8924460000	8924710000	8924270000	VSPC 2CL HF 12Vdc R	8951690000	8951710000	8951720000
<b>DIH Detecting Bus System</b>	VSPC 2CL HF 12Vdc	8924460000	8924710000	8924270000	VSPC 2CL HF 12Vdc R	8951690000	8951710000	8951720000
<b>Dupline/Miniplex</b>	VSPC 1CL 12Vdc 0,5A	8924450000	8924730000	8924290000	VSPC 1CL 12Vdc 0,5A R	8951540000	8951730000	8951740000
<b>EIB (European Installation Bus)</b>	VSPC 1CL 24Vdc 0,5A	892448 0000	8924730000	8924290000	VSPC 1CL 24Vdc 0,5A R	8951550000	8951730000	8951740000
<b>ET 200 E1</b>	VSPC 1CL 5Vdc 0,5A	8924420000	8924730000	8924290000	VSPC 1CL 5Vdc 0,5A R	8951530000	8951730000	8951740000
	VSPC Uko	8924660000	8924710000	8924270000				
	VSPC 2CL HF 5Vdc	8924430000	8924710000	8924270000	VSPC 2CL HF 5Vdc R	8951680000	8951710000	8951720000
<b>FIPIO/FIPWAY</b>	VSPC 2CL HF 5Vdc	8924430000	8924710000	8924270000	VSPC 2CL HF 5Vdc R	8951680000	8951710000	8951720000
<b>Genius I/O Bus</b>	VSPC 2CL 12Vdc 0,5A	8924440000	8924710000	8924270000	VSPC 2CL 12Vdc 0,5A R	8951470000	8951710000	8951720000
<b>Hart</b>	VSPC 1CL 24Vdc 0,5A	892448 0000	8924730000	8924290000	VSPC 1CL 24Vac 0,5A R	8951560000	8951730000	8951740000
<b>HDSL</b>	VSPC Uko	8924660000	8924710000	8924270000				
<b>IEC-BUS</b>	VSPC 2CL HF 5Vdc	8924430000	8924710000	8924270000	VSPC 2CL HF 5Vdc R	8951680000	8951710000	8951720000
<b>ISDN Basic connection (Uk0-Bus)</b>	VSPC Uko	8924660000	8924710000	8924270000				
<b>Cathodic corrosion prevention</b>	VSPC GDT 2ch 90V20kA	8924570000	8924740000	8924300000				
<b>LON (Works)</b>	VSPC 1CL 48Vac 0,5A	8924520000	8924730000	8924290000				
<b>LRE Networks</b>	VSPC 2CL HF 5Vdc	8924430000	8924710000	8924270000	VSPC 2CL HF 5Vdc R	8951680000	8951710000	8951720000
<b>LUXMATE-Bus</b>	VSPC 2CL HF 24Vdc	8924510000	8924710000	8924270000	VSPC 2CL HF 24Vdc R	8951700000	8951710000	8951720000
<b>M-Bus (Remote readout of counter)</b>	VSPC 1CL 24Vac 0,5A	8924500000	8924730000	8924290000	VSPC 1CL 24Vdc 0,5A R	8951550000	8951730000	8951740000
<b>MODBUS(-PLUS)</b>	VSPC 2CL HF 12Vdc	8924460000	8924710000	8924270000	VSPC 2CL HF 12Vdc R	8951690000	8951710000	8951720000
<b>MPI-Bus</b>	VSPC R485 2ch	8924670000	8924710000	8924270000			8951710000	8951720000
<b>N1 LAN</b>	VSPC 2CL HF 5Vdc	8924430000	8924710000	8924270000	VSPC 2CL HF 5Vdc R	8951680000	8951710000	8951720000
<b>N2 Bus</b>	VSPC 2SL 5Vdc 0,5A	8924210000	8924720000	8924280000	VSPC 2SL 5Vdc 0,5A R	8951610000	8951770000	8951780000
<b>P-NET</b>	VSPC 2CL HF 12Vdc	8924460000	8924710000	8924270000	VSPC 2CL HF 12Vdc R	8951690000	8951710000	8951720000
<b>Procontic CS31</b>	VSPC 1CL 12Vdc 0,5A	8924450000	8924730000	8924290000	VSPC 1CL 12Vdc 0,5A R	8951540000	8951730000	8951740000
	VSPC 2CL HF 12Vdc	8924460000	8924710000	8924270000	VSPC 2CL HF 12Vdc R	8951690000	8951710000	8951720000
<b>Procontic T200</b>	VSPC 2CL HF 12Vdc	8924460000	8924710000	8924270000	VSPC 2CL HF 12Vdc R	8951690000	8951710000	8951720000
<b>Profibus DP (FMS)</b>	VSPC 2CL HF 5Vdc	8924430000	8924710000	8924270000	VSPC 2CL HF 5Vdc R	8951680000	8951710000	8951720000
	VSPC 2CL HF 12Vdc	8924460000	8924710000	8924270000	VSPC 2CL HF 12Vdc R	8951690000	8951710000	8951720000
<b>Process-Bus, Panel-Bus</b>	VSPC 2CL HF 12Vdc	8924460000	8924710000	8924270000	VSPC 2CL HF 12Vdc R	8951690000	8951710000	8951720000
<b>PT100</b>	VSPC 3/4WIRE 24VDC	8924550000	8924740000	8924300000				
<b>P-Bus</b>	PU III R 24Vdc	8860360000			PU III R 24Vdc	8860360000		
<b>PSM-EG-RS422...</b>	VSPC 2CL HF 12Vdc	8924460000	8924710000	8924270000	VSPC 2CL HF 12Vdc R	8951690000	8951710000	8951720000
<b>PSM-EG-RS485...</b>	VSPC 2CL HF 12Vdc	8924460000	8924710000	8924270000	VSPC 2CL HF 12Vdc R	8951690000	8951710000	8951720000
<b>RACKBUS</b>	VSPC 2CL HF 5Vdc	8924430000	8924710000	8924270000	VSPC 2CL HF 5Vdc R	8951680000	8951710000	8951720000
<b>RS 422A, V.11, X.27, RS 423A</b>	VSPC 2CL HF 12Vdc	8924460000	8924710000	8924270000	VSPC 2CL HF 12Vdc R	8951690000	8951710000	8951720000
<b>RS 449</b>	VSPC 2CL HF 12Vdc	8924460000	8924710000	8924270000	VSPC 2CL HF 12Vdc R	8951690000	8951710000	8951720000
<b>RS 485</b>	VSPC R485 2ch	8924670000	8924710000	8924270000	VSPC R485 2ch R	8951670000	8951710000	8951720000
<b>RS-232-C/V.24</b>	VSPC 2CL HF 12Vdc	8924460000	8924710000	8924270000	VSPC 2CL HF 12Vdc R	8951690000	8951710000	8951720000
<b>SDLC</b>	VSPC 2CL HF 12Vdc	8924460000	8924710000	8924270000	VSPC 2CL HF 12Vdc R	8951690000	8951710000	8951720000
<b>SDSL</b>	VSPC Uko	8924660000	8924710000	8924270000				
<b>SecurLan-LON-Bus</b>	VSPC 1CL 12Vdc 0,5A	8924450000	8924730000	8924290000	VSPC 1CL 12Vdc 0,5A R	8951540000	8951730000	8951740000
<b>SHDSL</b>	VSPC Uko	8924660000	8924710000	8924270000				
<b>SINEC L1</b>	VSPC 2CL HF 5Vdc	8924430000	8924710000	8924270000	VSPC 2CL HF 5Vdc R	8951680000	8951710000	8951720000
<b>SINEC L2 DP</b>	VSPC 2CL HF 5Vdc	8924430000	8924710000	8924270000	VSPC 2CL HF 5Vdc R	8951680000	8951710000	8951720000
<b>Profibus DP</b>	VSPC R485 2ch	8924670000	8924710000	8924270000	VSPC R485 2ch R	8951670000	8951710000	8951720000
<b>T-DSL</b>	VSPC Uko	8924660000	8924710000	8924270000				
<b>Telephone analog</b>	VSPC Uko	8924660000	8924710000	8924270000				
<b>TTY 0(4) - 20 mA</b>	VSPC 2CL 24Vdc 0,5A	8924470000	8924710000	8924270000	VSPC 2CL 24Vdc 0,5A R	8951480000	8951710000	8951720000
<b>U-BUS</b>	VSPC GDT 2ch 90V20kA	8924570000	8924740000	8924300000				
<b>VDSL</b>	VSPC Uko	8924660000	8924710000	8924270000				
<b>V.35</b>	VSPC 2CL HF 5Vdc	8924430000	8924710000	8924270000	VSPC 2CL HF 5Vdc R	8951680000	8951710000	8951720000
<b>X.21/X.24</b>	VSPC 2CL HF 12Vdc	8924460000	8924710000	8924270000	VSPC 2CL HF 12Vdc R	8951690000	8951710000	8951720000
<b>X.25/X.31</b>	VSPC 2CL HF 12Vdc	8924460000	8924710000	8924270000	VSPC 2CL HF 12Vdc R	8951690000	8951710000	8951720000

This tables contains recommendations for the choice of device. Our technical consultants will be glad to assist you with your individual requirements.

## VARITECTOR SPC

### VSPC 1CL – Protection for one analogue signal

- Optional monitoring function with status indicator and alert function
- Pluggable arrester (plug-in / disconnect interruption-free and impedance neutral)
- Testable with V-TEST instrument
- Version with non-earthed PE connection for avoiding potential differences
- Usable in accordance with installations standard IEC 62305
- Integrated PE contact in base element, safely discharges up to 20 kA (8/20 μs) and 2.5 kA (10/350 μs) to PE



#### Technical data

##### for all VSPC 1CL

Dielectric strength with FG against PE	> 500 V
Volume resistivity per path	2.2 Ω
Overstressed fault mode	Mode 2
Requirement category acc. to IEC 61643-21	C1; C2; C3; D1
Surge strength C1	< 1 kA / 8/20 μs
Surge strength C2	5 kA / 8/20 μs
Surge strength C3	100 A / 10/1000 μs
Surge strength D1	1 kA 10/350 μs
Rated discharge current $I_{n1}$ (8/20 μs) wire-wire / wire-PE / GND-PE	2.5 kA / 2.5 kA / 2.5 kA
Rated discharge current $I_{n2}$ (8/20 μs) wire-wire / wire-PE / GND-PE	10 kA / 10 kA / 10 kA
Lightning test current $I_{imp}$ (10/350 μs) wire-wire / wire-PE / GND-PE	2.5 kA / 2.5 kA / 2.5 kA
Type of connection	Pluggable in VSPC BASE
Storage temperature	-40 °C...+80 °C
Ambient temperature (operational)	-40 °C...+70 °C
Rel. humidity	5 %...96 % RH
Degree of protection	IP20

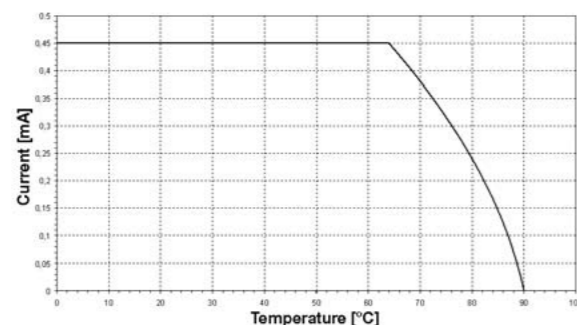
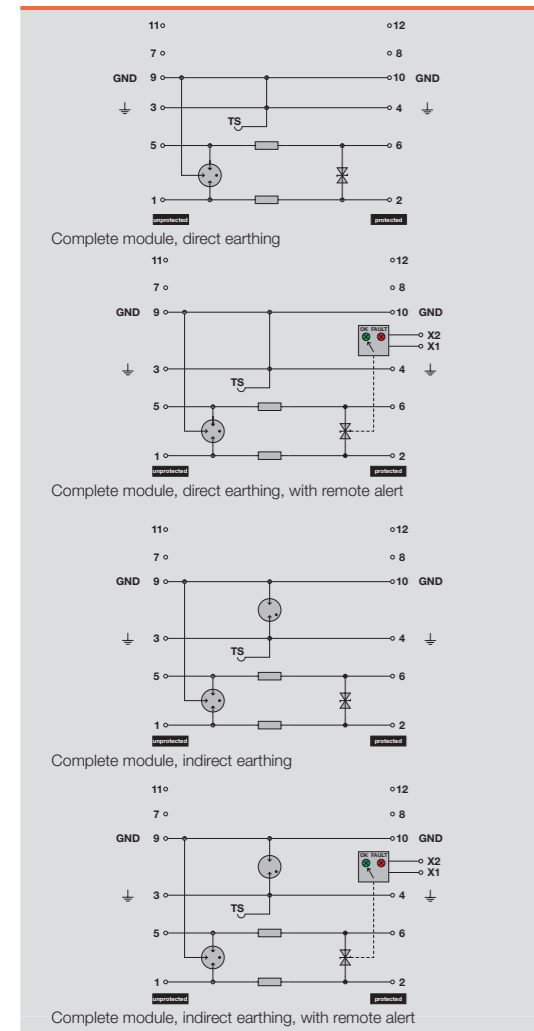

Dimensions of complete module (arrester + base element)	Without telecomm. contact	With telecomm. contact (R)
Length x Width x Height	mm 90 x 17.8 x 69	98 x 17.8 x 69

**Note**

#### Base elements / base to arresters



#### Ordering data for base

Type	Qty.	Order No.
Base element, direct earthing	1	8924730000
Base element, indirect earthing via spark gap (FG, floating ground)	1	8924290000
Base element, direct earthing with remote alert	1	8951730000
Base element, indirect earthing with remote alert	1	8951740000

**Note:** The basis elements are to be ordered separately

VSPC 1CL – arrester / plug-in elements



B



Ordering data	VSPC 1CL 5 V DC	VSPC 1CL 12 V DC	VSPC 1CL 24 V DC
Rated voltage (DC)	5 V DC	12 V DC	24 V DC
Max. continuous voltage, U <sub>c</sub> (DC)	6.4 V DC	15 V DC	28 V DC
Alternating-current strength			
Rated current	450 mA	450 mA	450 mA
Surge strength			
Signaling contact	U <sub>n</sub> 250 V AC 0.1 A 1CO at VSPC R with VSPC CONTROL UNIT	U <sub>n</sub> 250 V AC 0.1 A 1CO at VSPC R with VSPC CONTROL UNIT	U <sub>n</sub> 250 V AC 0.1 A 1CO at VSPC R with VSPC CONTROL UNIT
Optical function indicator (VSPC R)	green = OK; red = arrester faulty, replace	green = OK; red = arrester faulty, replace	green = OK; red = arrester faulty, replace
Transmission test (-3dB)	730 KHz	730 KHz	730 KHz
Impulse reset	20 ms	20 ms	30 ms
tested	acc. to IEC61643-21	acc. to IEC61643-21	acc. to IEC61643-21
Residual voltage U <sub>r</sub>	< 650 V	< 650 V	< 650 V
wire-wire / wire-PE / GND-PE	12 V / 450 V / 650 V	25 V / 450 V / 650 V	45 V / 450 V / 650 V
Protection level on output side sym., input 1 kV/μs, typ.	< 12 V	< 25 V	< 45 V
input 8/20 μs, typ.	< 12 V	< 25 V	< 45 V
Protection level on output side unsym., input 1 kV/μs, typ.	< 450 V	< 450 V	< 450 V
input 8/20 μs, typ.	< 650 V	< 650 V	< 650 V
<b>Ordering data</b>			
Without signaling contact/function indicator	VSPC 1CL 5VDC 0.5A	VSPC 1CL 12VDC 0.5A	VSPC 1CL 24VDC 0.5A
Order No.	<b>8924420000</b>	<b>8924450000</b>	<b>8924480000</b>
With signaling contact/function indicator	VSPC 1CL 5VDC 0.5A R	VSPC 1CL 12VDC 0.5A R	VSPC 1CL 24VDC 0.5A R
Order No.	<b>8951530000</b>	<b>8951540000</b>	<b>8951550000</b>
Qty.	1 piece	1 piece	1 piece
<b>Note</b>			

Ordering data	VSPC 1CL 24 V AC	VSPC 1CL 48 V AC	VSPC 1CL 60 V AC
Rated voltage (DC)	24 V AC / 34 V DC	48 V AC / 68 V DC	60 V AC / 85 V DC
Max. continuous voltage, U <sub>c</sub> (DC)	28 V AC / 39 V DC	60 V AC / 85 V DC	72 V AC / 101 V DC
Alternating-current strength			
Rated current	450 mA	350 mA	250 mA
Surge strength			
Signaling contact	U <sub>n</sub> 250 V AC 0.1 A 1CO at VSPC R with VSPC CONTROL UNIT	no	no
Optical function indicator (VSPC R)	green = OK; red = arrester faulty, replace	green = OK; red = arrester faulty, replace	green = OK; red = arrester faulty, replace
Transmission test (-3dB)	730 KHz	730 KHz	730 KHz
Impulse reset	30 ms	100 ms	100 ms
tested	acc. to IEC61643-21	acc. to IEC61643-21	acc. to IEC61643-21
Residual voltage U <sub>r</sub>	< 650 V	< 650 V	< 650 V
wire-wire / wire-PE / GND-PE	60 V / 450 V / 650 V	85 V / 450 V / 650 V	100 V / 450 V / 650 V
Protection level on output side sym., input 1 kV/μs, typ.	< 60 V	< 85 V	< 100 V
input 8/20 μs, typ.	< 60 V	< 85 V	< 100 V
Protection level on output side unsym., input 1 kV/μs, typ.	< 450 V	< 450 V	< 450 V
input 8/20 μs, typ.	< 650 V	< 650 V	< 650 V
<b>Ordering data</b>			
Without signaling contact/function indicator	VSPC 1CL 24VAC 0.5A	VSPC 1CL 48VAC 0.5A	VSPC 1CL 60VAC 0.5A
Order No.	<b>8924500000</b>	<b>8924520000</b>	<b>8924530000</b>
With signaling contact/function indicator	VSPC 1CL 24VAC 0.5A R		
Order No.	<b>8951560000</b>		
Qty.	1 piece	1 piece	1 piece
<b>Note</b>			

## VARITECTOR SPC

### VSPC 2CL – Protection for two analogue signals

- Optional monitoring function with status indicator and alert function
- Pluggable arrester (plug-in / disconnect interruption-free and impedance neutral)
- Testable with V-TEST instrument
- Space-saving design for two analog signals with signaling contact, without additional space requirements
- Version with non-earthed PE connection for avoiding potential differences
- Usable in accordance with installations standard IEC 62305
- Integrated PE contact in base element, safely discharges up to 20 kA (8/20  $\mu$ s) and 2.5 kA (10/350  $\mu$ s) to PE



### Technical data

#### for all VSPC 2CL

Dielectric strength with FG against PE	> 500 V
Volume resistivity per path	2.2 $\Omega$
Overstressed fault mode	Mode 2
Requirement category acc. to IEC 61643-21	C1; C2; C3; D1
Surge strength C1	< 1 kA / 8/20 $\mu$ s
Surge strength C2	5 kA / 8/20 $\mu$ s
Surge strength C3	100 A / 10/1000 $\mu$ s
Surge strength D1	1 kA 10/350 $\mu$ s
Rated discharge current $I_{n1}$ (8/20 $\mu$ s) wire-wire / wire-PE / GND-PE	2.5 kA / 2.5 kA / 2.5 kA
Rated discharge current $I_{n2}$ (8/20 $\mu$ s) wire-wire / wire-PE / GND-PE	10 kA / 2 x 10 kA / 10kA
Lightning test current, $I_{imp}$ (10/350 $\mu$ s) wire-wire / wire-PE / GND-PE	2.5 kA / 2.5 kA / 2.5 kA
Degree of protection	IP20
Type of connection	Pluggable in VSPC BASE
Storage temperature	-40 °C...+80 °C
Ambient temperature (operational)	-40 °C...+70 °C
Rel. humidity	5 %...96 % RH
Degree of protection	IP20

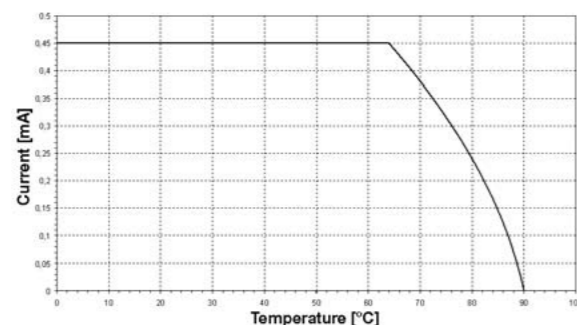
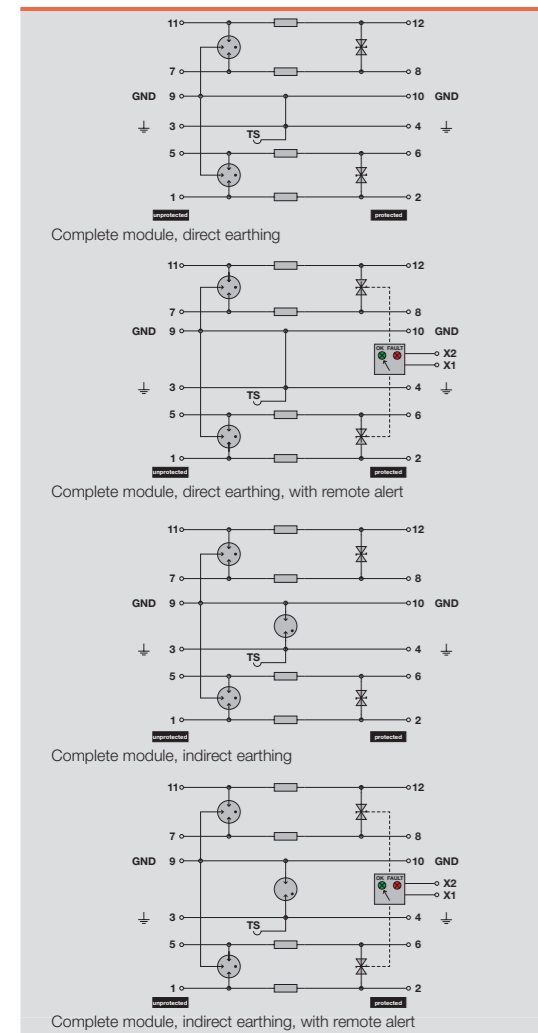

Dimensions of complete module (arrester + base element)	Without telecomm. contact	With telecomm. contact (R)
Length x Width x Height	mm 90 x 17.8 x 69	98 x 17.8 x 69

#### Note

### Base elements / base to arresters



### Ordering data for base

Type	Qty.	Order No.
Base element, direct earthing	1	8924710000
Base element, indirect earthing via spark gap (FG, floating ground)	1	8924270000
Base element, direct earthing with remote alert	1	8951710000
Base element, indirect earthing with remote alert	1	8951720000

**Note:** The basis elements are to be ordered separately

VSPC 2CL – arrester / plug-in elements



Ordering data	VSPC 2CL 5 V DC	VSPC 2CL 12 V DC	VSPC 2CL 24 V DC
Rated voltage (DC)	5 V DC	12 V DC	24 V DC
Max. continuous voltage, U <sub>c</sub> (DC)	6.4 V DC	15 V DC	28 V DC
Alternating-current strength			
Rated current	450 mA	450 mA	450 mA
Surge strength			
Signaling contact	U <sub>n</sub> 250 V AC 0.1 A 1CO at VSPC R with VSPC CONTROL UNIT green = OK; red = arrester faulty, replace	U <sub>n</sub> 250 V AC 0.1 A 1CO at VSPC R with VSPC CONTROL UNIT green = OK; red = arrester faulty, replace	U <sub>n</sub> 250 V AC 0.1 A 1CO at VSPC R with VSPC CONTROL UNIT green = OK; red = arrester faulty, replace
Optical function indicator (VSPC R)			
Transmission test (-3dB)	730 KHz	2.4 MHz	2.2 MHz
Impulse reset	20 ms	20 ms	30 ms
tested	acc. to IEC61643-21	acc. to IEC61643-21	acc. to IEC61643-21
Residual voltage U <sub>r</sub>	< 800 V	< 800 V	< 800 V
wire-wire / wire-PE / GND-PE	12 V / 450 V / 800 V	25 V / 450 V / 800 V	45 V / 450 V / 800 V
Protection level on output side sym.,			
input 1 kV/μs, typ.	< 12 V	< 25 V	< 45 V
input 8/20 μs, typ.	< 12 V	< 25 V	< 45 V
Protection level on output side unsym.,			
input 1 kV/μs, typ.	< 450 V	< 450 V	< 450 V
input 8/20 μs, typ.	< 800 V	< 800 V	< 800 V
<b>Ordering data</b>			
Without signaling contact/function indicator Type	VSPC 2CL 5VDC 0.5A	VSPC 2CL 12VDC 0.5A	VSPC 2CL 24VDC 0.5A
Order No.	<b>892440000</b>	<b>892444000</b>	<b>892447000</b>
With signaling contact/function indicator Type	VSPC 2CL 5VDC 0.5A R	VSPC 2CL 12VDC 0.5A R	VSPC 2CL 24VDC 0.5A R
Order No.	<b>895146000</b>	<b>895147000</b>	<b>895148000</b>
Qty.	1 piece	1 piece	1 piece
<b>Note</b>			

B



Ordering data	VSPC 2CL 24 V AC	VSPC 2CL 48 V AC	VSPC 2CL 60 V AC
Rated voltage (DC)	24 V AC / 34 V DC	48 V AC / 68 V DC	60 V AC / 85 V DC
Max. continuous voltage, U <sub>c</sub> (DC)	28 V AC / 39 V DC	60 V AC / 85 V DC	72 V AC / 101 V DC
Alternating-current strength			
Rated current	450 mA	350 mA	250 mA
Surge strength			
Signaling contact	U <sub>n</sub> 250 V AC 0.1 A 1CO at VSPC R with VSPC CONTROL UNIT green = OK; red = arrester faulty, replace	no	no
Optical function indicator (VSPC R)			
Transmission test (-3dB)	3 MHz	3 MHz	7 MHz
Impulse reset	450 ms	500 ms	500 ms
tested	acc. to IEC61643-21	acc. to IEC61643-21	acc. to IEC61643-21
Residual voltage U <sub>r</sub>	< 650 V	< 650 V	< 650 V
wire-wire / wire-PE / GND-PE	60 V / 450 V / 800 V	85 V / 450 V / 650 V	100 V / 450 V / 650 V
Protection level on output side sym.,			
input 1 kV/μs, typ.	< 60 V	< 85 V	< 100 V
input 8/20 μs, typ.	< 60 V	< 85 V	< 100 V
Protection level on output side unsym.,			
input 1 kV/μs, typ.	< 450 V	< 450 V	< 450 V
input 8/20 μs, typ.	< 800 V	< 650 V	< 650 V
<b>Ordering data</b>			
Without signaling contact/function indicator Type	VSPC 2CL 24VAC 0.5A	VSPC 2CL 48VAC 0.5A	VSPC 2CL 60VAC 0.5A
Order No.	<b>892449000</b>	<b>895149000</b>	<b>895150000</b>
With signaling contact/function indicator Type	VSPC 2CL 24VAC 0.5A R		
Order No.	<b>109340000</b>		
Qty.	1 piece	1 piece	1 piece
<b>Note</b>			



## VARITECTOR SPC

### VSPC 2CL HF – for high transmission rates without signal delays

- Optional monitoring function with status indicator and alert function
- Pluggable arrester (plug-in / disconnect interruption-free and impedance neutral)
- Testable with V-TEST instrument
- Space-saving design with optional signaling contact, without additional space requirements
- High transmission rates with low attenuation values
- Usable in accordance with installations standard IEC 62305
- Integrated PE contact in base element, safely discharges up to 20 kA (8/20  $\mu$ s) and 2.5 kA (10/350  $\mu$ s) to PE



### Technical data

#### for all VSPC 2CL HF

Dielectric strength with FG against PE	> 500 V
Rated current	450 mA
Volume resistivity per path	2.2 $\Omega$
Overstressed fault mode	Mode 2
Requirement category acc. to IEC 61643-21	C1; C2; C3; D1
Surge strength C1	< 1 kA / 8/20 $\mu$ s
Surge strength C2	5 kA / 8/20 $\mu$ s
Surge strength C3	100 A / 10/1000 $\mu$ s
Surge strength D1	1 kA 10/350 $\mu$ s
Rated discharge current $I_{n1}$ (8/20 $\mu$ s) wire-wire / wire-PE / GND-PE	2.5 kA / 2.5 kA / 2.5 kA
Rated discharge current $I_{n2}$ (8/20 $\mu$ s) wire-wire / wire-PE / GND-PE	10 kA / 2 x 10 kA / 10kA
Lightning test current $I_{n3}$ (10/350 $\mu$ s) wire-wire / wire-PE / GND-PE	2.5 kA / 2.5 kA / 2.5 kA
Degree of protection	IP20
Type of connection	Pluggable in VSPC BASE
Storage temperature	-40 °C...+80 °C
Ambient temperature (operational)	-40 °C...+70 °C
Rel. humidity	5 %...96 % RH
Degree of protection	IP20

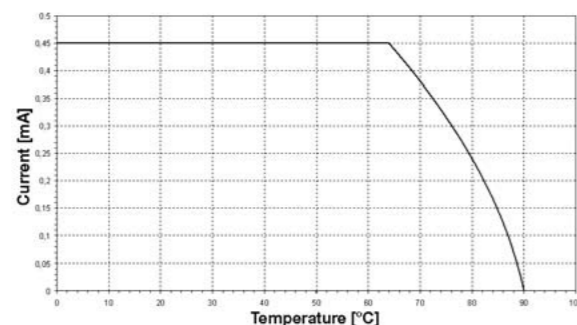
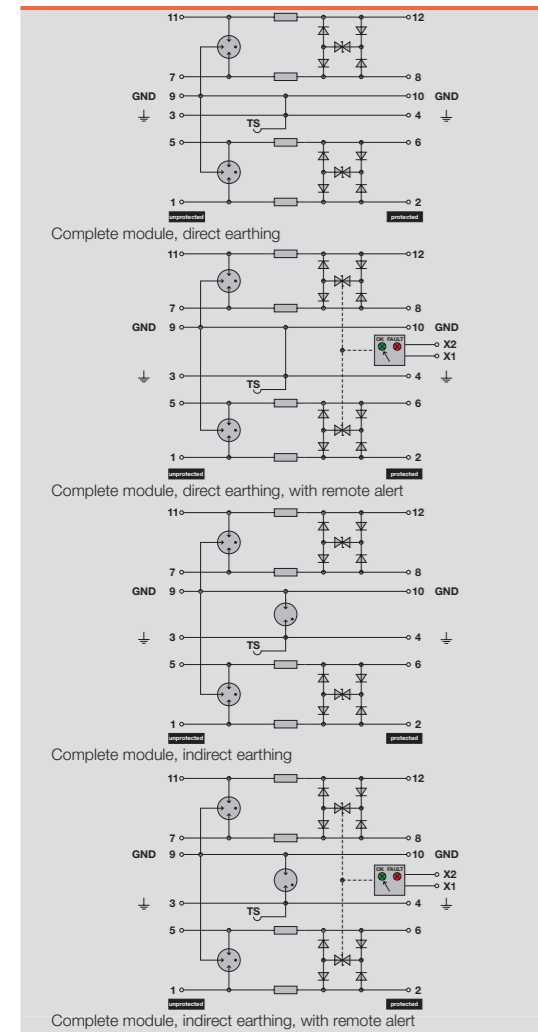

Dimensions of complete module (arrester + base element)	Without telecomm. contact	With telecomm. contact (R)
Length x Width x Height	mm 90 x 17.8 x 69	98 x 17.8 x 69

#### Note

### Base elements / base to arresters



### Ordering data for base

Type	Qty.	Order No.
Base element, direct earthing	1	8924710000
Base element, indirect earthing via spark gap (FG, floating ground)	1	8924270000
Base element, direct earthing with remote alert	1	8951710000
Base element, indirect earthing with remote alert	1	8951720000

**Note:** The basis elements are to be ordered separately

VSPC 2CL HF – arrester / plug-in elements



B



Ordering data	VSPC 2CL HF 5 V DC	VSPC 2CL HF 12 V DC	VSPC 2CL HF 24 V DC
Rated voltage (DC)	5 V DC	12 V DC	24 V DC
Max. continuous voltage, U <sub>c</sub> (DC)	6.4 V DC	15 V DC	28 V DC
Alternating-current strength			
Surge strength			
Signaling contact	U <sub>n</sub> 250 V AC 0.1 A 1CO at VSPC R with VSPC CONTROL UNIT	U <sub>n</sub> 250 V AC 0.1 A 1CO at VSPC R with VSPC CONTROL UNIT	U <sub>n</sub> 250 V AC 0.1 A 1CO at VSPC R with VSPC CONTROL UNIT
Optical function indicator (VSPC R)	green = OK; red = arrester faulty, replace	green = OK; red = arrester faulty, replace	green = OK; red = arrester faulty, replace
Transmission test (-3dB)	1.5 MHz	1.5 MHz	1.5 MHz
Impulse reset	20 ms	20 ms	40 ms
tested	acc. to IEC61643-21	acc. to IEC61643-21	acc. to IEC61643-21
Residual voltage U <sub>r</sub>	< 800 V	< 800 V	< 800 V
wire-wire / wire-PE / GND-PE	12 V / 450 V / 800 V	25 V / 450 V / 800 V	45 V / 450 V / 800 V
Protection level on output side sym., input 1 kV/μs, typ.	< 12 V	< 25 V	< 45 V
input 8/20 μs, typ.	< 12 V	< 25 V	< 45 V
Protection level on output side unsym., input 1 kV/μs, typ.	< 450 V	< 450 V	< 450 V
input 8/20 μs, typ.	< 800 V	< 800 V	< 800 V
<b>Ordering data</b>			
Without signaling contact/function indicator Type	VSPC 2CL HF 5VDC	VSPC 2CL HF 12VDC	VSPC 2CL HF 24VDC
Order No.	<b>8924430000</b>	<b>8924460000</b>	<b>8924510000</b>
With signaling contact/function indicator Type	VSPC 2CL HF 5VDC R	VSPC 2CL HF 12VDC R	VSPC 2CL HF 24VDC R
Order No.	<b>8951680000</b>	<b>8951690000</b>	<b>8951700000</b>
Qty.	1 piece	1 piece	1 piece
<b>Note</b>			

**VARITECTOR SPC**

**VSPC 1CL PW – combinations of current loop signal and circuit breaker**

- Optional monitoring function with status indicator
- Pluggable arrester (plug-in / disconnect interruption-free and impedance neutral)
- Usable in accordance with installations standard IEC 62305
- Integrated PE contact in base element, safely discharges up to 20 kA (8/20 μs) and 2.5 kA (10/350 μs) to PE



**B**

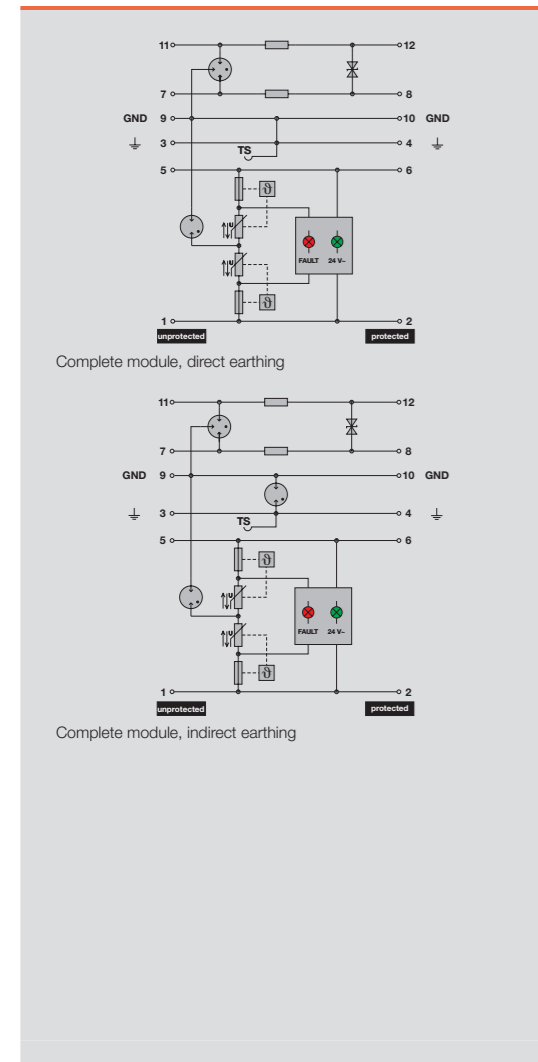

**Technical data**

for all VSPC 1CL PW		
<b>C&amp;I protection data</b>		
Rated voltage (DC)	24 V AC / 34 V DC	
Max. continuous voltage, U <sub>c</sub> (DC)	27 V AC / 38 V DC	
Dielectric strength with FG against PE	> 500 V	
Rated current	450 mA	
Volume resistivity per path	2.2 Ω	
Overstressed fault mode	Mode 2	
Requirement category acc. to IEC 61643-21	C1; C2; C3; D1	
Optical function indicator	green = OK; red = arrester faulty, replace	
Rated voltage (AC/DC)	24 V AC / 33 V DC	
Surge strength C1	< 1 kA / 8/20 μs	
Surge strength C2	5 kA / 8/20 μs	
Surge strength C3	100 A / 10/1000 μs	
Surge strength D1	2.5 kA / 10/350 μs	
Transmission test (-3dB)	730 KHz	
Impulse reset	10 ms	
tested	acc. to IEC61643-21, IEC61643-1	
Rated discharge current I <sub>n</sub> (8/20 μs) wire-wire / wire-PE / GND-PE	2.5 kA / 2.5 kA / 2.5 kA	
Rated discharge current I <sub>max</sub> (8/20 μs) wire-wire / wire-PE / GND-PE	10 kA / 10 kA / 10 kA	
Lightning test current, I <sub>imp</sub> (10/350 μs) wire-wire / wire-PE / GND-PE	2.5 kA / 2.5 kA / 2.5 kA	
Residual voltage U <sub>p</sub>	800 V	
Residual voltage U <sub>p</sub> wire-wire / wire-PE / GND-PE	60 V / 450 V / 800 V	
Protection level on output side sym., input 1 kV/μs, typ.	< 60 V	
Protection level on output side sym., input 8/20 μs, typ.	< 60 V	
Protection level on output side unsym., input 1 kV/μs, typ.	< 450 V	
Protection level on output side unsym., input 8/20 μs, typ.	< 800 V	
<b>Protection of the device</b>		
Rated voltage (DC)	24 V AC / 34 V DC	
Max. continuous voltage, U <sub>c</sub> (DC)	27 V AC / 38 V DC	
Combined pulse	6 kV	
Residual voltage U <sub>c</sub>	900 V	
Rated current	10 A	
<b>General data</b>		
Type of connection	Pluggable in VSPC BASE	
Storage temperature	-40 °C...+80 °C	
Requirement category acc. to IEC 61643-1	Class III	
Ambient temperature (operational)	-40 °C...+70 °C	
Rel. humidity	5 %...96 % RH	
Degree of protection	IP20	
<b>Dimensions of complete module (arrester + base element) Without telecomm. contact With telecomm. contact (R)</b>		
Length x Width x Height	mm	90 x 17.8 x 69 98 x 17.8 x 69
<b>Note</b>		

**Base elements / base to arresters**



**Ordering data for base**

Type	Qty.	Order No.
Base element, direct earthing	1	1070230000
Base element, indirect earthing via spark gap (FG, floating ground)	1	1105700000

**Note:** The basis elements are to be ordered separately

VSPC 1CL PW – arrester / plug-in elements



Ordering data

Without signaling contact/function indicator		Type	
Order No.		VSPC 1CL PW 24V 0.5A	
Qty.		1 piece	
<b>Note</b>			

VSPC 1CL PW 24 V

Order No.	8951510000
Qty.	1 piece

B

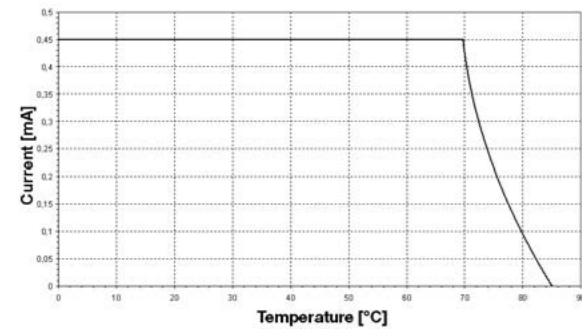

## VARITECTOR SPC

### VSPC 2SL – Protection for two binary signals

- Optional monitoring function with status indicator and alert function
- Pluggable arrester (plug-in / disconnect interruption-free and impedance neutral)
- Testable with V-TEST instrument
- Version with non-earthed PE connection for avoiding potential differences
- Usable in accordance with installations standard IEC 62305
- Integrated PE contact in base element, safely discharges up to 20 kA (8/20 μs) and 2.5 kA (10/350 μs) to PE



### Technical data

for all VSPC 2SL	
Dielectric strength with FG against PE	> 500 V
Volume resistivity per path	4.7 Ω
Overstressed fault mode	Mode 2
Requirement category acc. to IEC 61643-21	C1; C2; C3; D1
Surge strength C1	< 1 kA / 8/20 μs
Surge strength C2	5 kA / 8/20 μs
Surge strength C3	100 A / 10/1000 μs
Surge strength D1	2.5 kA 10/350 μs
Rated discharge current $I_{n1}$ (8/20 μs) wire-wire / wire-PE / GND-PE	2.5 kA / 2.5 kA / 2.5 kA
Rated discharge current $I_{n2}$ (8/20 μs) wire-wire / wire-PE / GND-PE	10 kA / 10 kA / 10kA
Lightning test current $I_{imp}$ (10/350 μs) wire-wire / wire-PE / GND-PE	2.5 kA / 2.5 kA / 2.5 kA
Type of connection	Pluggable in VSPC BASE
Storage temperature	-40 °C...+80 °C
Ambient temperature (operational)	-40 °C...+70 °C
Rel. humidity	5 %...96 % RH
Degree of protection	IP20

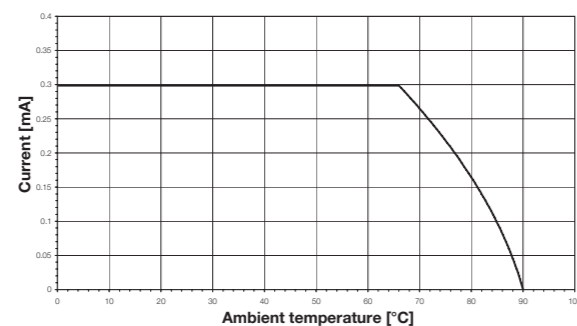
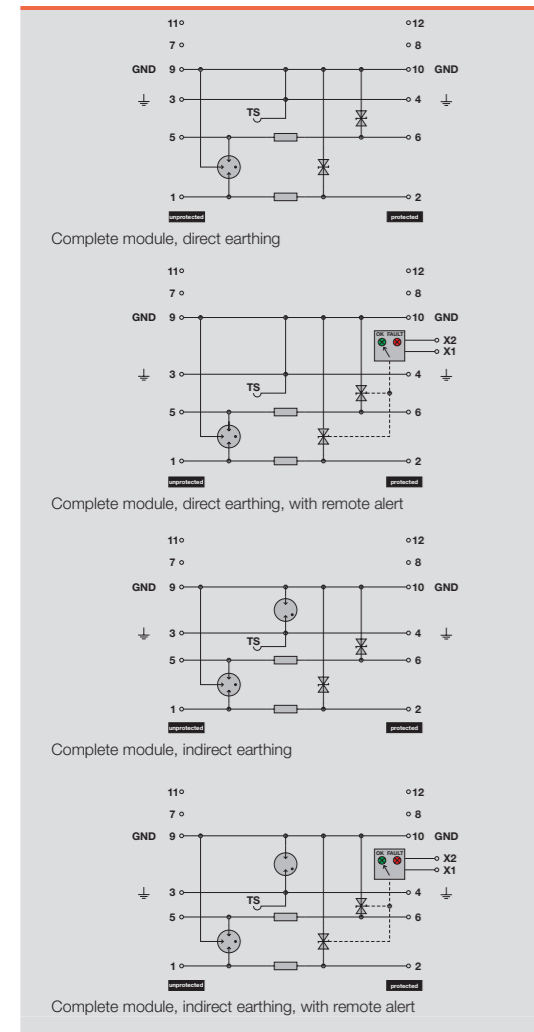

Dimensions of complete module (arrester + base element)	Without telecomm. contact	With telecomm. contact (R)
Length x Width x Height	mm 90 x 17.8 x 69	98 x 17.8 x 69

**Note**

### Base elements / base to arresters



### Ordering data for base

Type	Qty.	Order No.
Base element, direct earthing	1	8924720000
Base element, indirect earthing via spark gap (FG, floating ground)	1	8924280000
Base element, direct earthing with remote alert	1	8951770000
Base element, indirect earthing with remote alert	1	8951780000

**Note:** The basis elements are to be ordered separately

VSPC 2SL – arrester / plug-in elements



B



Ordering data	VSPC 2SL 5 V DC	VSPC 2SL 12 V DC	VSPC 2SL 12 V AC	VSPC 2SL 24 V DC
Rated voltage $U_n$	5 V DC	12 V DC	12 V AC / 16 V DC	24 V DC
Max. continuous voltage $U_c$	6.4 V DC	15 V DC	13.2 V AC / 18 V DC	28 V DC
Signaling contact	$U_n$ , 250 V AC 0.1 A 1CO at VSPC R with VSPC CONTROL UNIT	$U_n$ , 250 V AC 0.1 A 1CO at VSPC R with VSPC CONTROL UNIT	no	$U_n$ , 250 V AC 0.1 A 1CO at VSPC R with VSPC CONTROL UNIT
Optical function indicator (VSPC R)	green = OK; red = arrester faulty, replace	green = OK; red = arrester faulty, replace	green = OK; red = arrester faulty, replace	green = OK; red = arrester faulty, replace
Transmission test (-3dB)	750 KHz	750 KHz	750 KHz	750 KHz
Impulse reset tested	20 ms	20 ms	20 ms	30 ms
Residual voltage $U_r$	acc. to IEC61643-21	acc. to IEC61643-21	acc. to IEC61643-21	acc. to IEC61643-21
wire-wire / wire-PE / GND-PE	< 25 V	< 50 V	< 50 V	< 60 V
Protection level on output side sym., input 1 kV/ $\mu$ s, typ.	25 V / 25 V / 25 V	45 V / 50 V / 50 V	55 V / 50 V / 50 V	80 V / 60 V / 60 V
Protection level on output side unsym., input 1 kV/ $\mu$ s, typ.	< 25 V	< 45 V	< 55 V	< 80 V
Protection level on output side unsym., input 8/20 $\mu$ s, typ.	< 25 V	< 45 V	< 55 V	< 80 V
Rated current	300 mA	300 mA	300 mA	300 mA
<b>Ordering data</b>				
Without signaling contact/function indicator Type	VSPC 2SL 5VDC 0.5A	VSPC 2SL 12VDC 0.5A	VSPC 2SL 12VAC 0.5A	VSPC 2SL 24VDC 0.5A
Order No.	<b>8924210000</b>	<b>8924230000</b>	<b>8924250000</b>	<b>8924330000</b>
With signaling contact/function indicator Type	VSPC 2SL 5VDC 0.5A R	VSPC 2SL 12VDC 0.5A R		VSPC 2SL 24VDC 0.5A R
Order No.	<b>8951610000</b>	<b>8951620000</b>		<b>8951630000</b>
Qty.	1 piece	1 piece	1 piece	1 piece
<b>Note</b>				

Ordering data	VSPC 2SL 24 V AC	VSPC 2SL 48 V AC	VSPC 2SL 60 V AC
Rated voltage $U_n$	24 V AC / 34 V DC	48 V AC / 68 V DC	60 V AC / 85 V DC
Max. continuous voltage $U_c$	28 V AC / 39 V DC	60 V AC / 85 V DC	72 V AC / 101 V DC
Signaling contact	$U_n$ , 250 V AC 0,1 A 1CO at VSPC R with VSPC CONTROL UNIT	no	no
Optical function indicator (VSPC R)	green = OK; red = arrester faulty, replace	green = OK; red = arrester faulty, replace	green = OK; red = arrester faulty, replace
Transmission test (-3dB)	750 KHz	750 KHz	750 KHz
Impulse reset tested	60 ms	60 ms	60 ms
Residual voltage $U_r$	acc. to IEC61643-21	acc. to IEC61643-21	acc. to IEC61643-21
wire-wire / wire-PE / GND-PE	< 60 V	< 125 V	< 165 V
Protection level on output side sym., input 1 kV/ $\mu$ s, typ.	80 V / 60 V / 60 V	80 V / 125 V / 125 V	80 V / 165 V / 165 V
Protection level on output side unsym., input 1 kV/ $\mu$ s, typ.	< 110 V	< 210 V	< 280 V
Protection level on output side unsym., input 8/20 $\mu$ s, typ.	< 80 V	< 80 V	< 80 V
Rated current	300 mA	250 mA	200 mA
<b>Ordering data</b>			
Without signaling contact/function indicator Type	VSPC 2SL 24VAC 0.5A	VSPC 2SL 48VAC 0.5A	VSPC 2SL 60VAC 0.5A
Order No.	<b>8924350000</b>	<b>8924370000</b>	<b>8924390000</b>
With signaling contact/function indicator Type	VSPC 2SL 24VAC 0.5A R		
Order No.	<b>8951640000</b>		
Qty.	1 piece	1 piece	1 piece
<b>Note</b>			



## VARITECTOR SPC

### VSPC 4SL – Protection for four binary signals

- Optional monitoring function with status indicator and alert function
- Pluggable arrester (plug-in / disconnect interruption-free and impedance neutral)
- Testable with V-TEST instrument
- Space-saving design for four binary signals with signaling contact, without additional space requirements
- Version with non-earthed PE connection for avoiding potential differences
- Usable in accordance with installations standard IEC 62305
- Integrated PE contact in base element, safely discharges up to 20 kA (8/20 μs) and 2.5 kA (10/350 μs) to PE



### Technical data

#### for all VSPC 4SL

Volume resistivity per path	4.7 Ω
Overstressed fault mode	Mode 2
Requirement category acc. to IEC 61643-21	C1; C2; C3; D1
Surge strength C1	< 1 kA / 8/20 μs
Surge strength C2	5 kA / 8/20 μs
Surge strength C3	100 A / 10/1000 μs
Surge strength D1	2.5 kA 10/350 μs
Rated discharge current $I_{n1}$ (8/20 μs) wire-wire / wire-PE / GND-PE	2.5 kA / 2.5 kA / 2.5 kA
Rated discharge current $I_{n2}$ (8/20 μs) wire-wire / wire-PE / GND-PE	10 kA / 10 kA / 10 kA
Lightning test current $I_{imp}$ (10/350 μs) wire-wire / wire-PE / GND-PE	2.5 kA / 2.5 kA / 2.5 kA
Type of connection	Pluggable in VSPC BASE
Storage temperature	-40 °C ... +80 °C
Ambient temperature (operational)	-40 °C ... +70 °C
Rel. humidity	5 % ... 96 % RH
Degree of protection	IP20

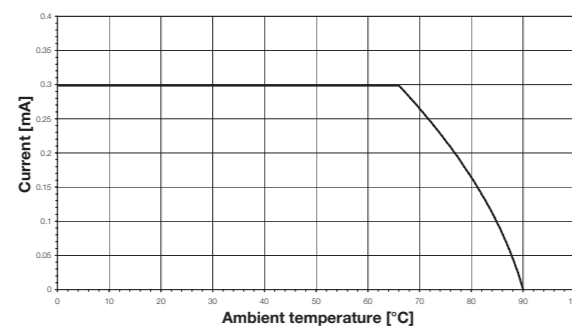
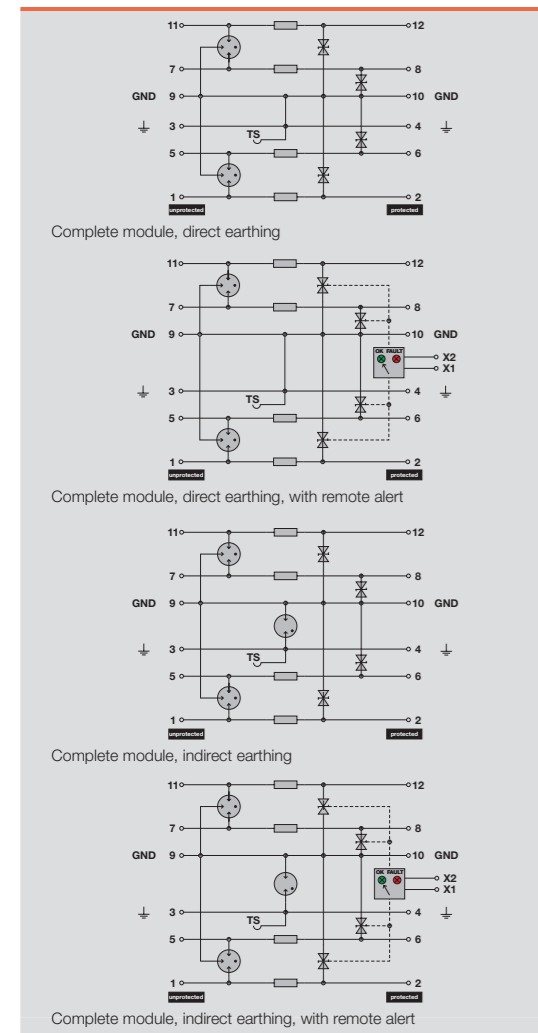

Dimensions of complete module (arrester + base element)	Without telecomm. contact	With telecomm. contact (R)
Length x Width x Height	mm 90 x 17.8 x 69	98 x 17.8 x 69

#### Note

### Base elements / base to arresters



### Ordering data for base

Type	Qty.	Order No.
Base element, direct earthing	1	8924700000
Base element, indirect earthing via spark gap (FG, floating ground)	1	8924260000
Base element, direct earthing with remote alert	1	8951750000
Base element, indirect earthing with remote alert	1	8951760000

**Note:** The basis elements are to be ordered separately

VSPC 4SL – arrester / plug-in elements



B



Ordering data	VSPC 4SL 5 V DC	VSPC 4SL 12 V DC	VSPC 4SL 12 V AC	VSPC 4SL 24 V DC
Rated voltage U <sub>n</sub>	5 V DC	12 V DC	12 V AC / 16 V DC	24 V DC
Max. continuous voltage U <sub>c</sub>	6.4 V DC	15 V DC	13.2 V AC / 18 V DC	28 V DC
Signaling contact	U <sub>n</sub> 250 V AC 0.1 A 1CO at VSPC R with VSPC CONTROL UNIT	U <sub>n</sub> 250 V AC 0.1 A 1CO at VSPC R with VSPC CONTROL UNIT	no	U <sub>n</sub> 250 V AC 0.1 A 1CO at VSPC R with VSPC CONTROL UNIT
Optical function indicator (VSPC R)	green = OK; red = arrester faulty, replace	green = OK; red = arrester faulty, replace	green = OK; red = arrester faulty, replace	green = OK; red = arrester faulty, replace
Transmission test (-3dB)	730 KHz	750 KHz	750 KHz	750 KHz
Impulse reset tested	20 ms	20 ms	20 ms	30 ms
Residual voltage U <sub>r</sub>	acc. to IEC61643-21	acc. to IEC61643-21	acc. to IEC61643-21	acc. to IEC61643-21
wire-wire / wire-PE / GND-PE	< 25 V	< 35 V	< 50 V	< 60 V
Protection level on output side sym., input 1 kV/μs, typ.	25 V / 25 V / 25 V	45 V / 20 V / 450 V	55 V / 50 V / 50 V	80 V / 60 V / 60 V
input 8/20 μs, typ.	< 25 V	< 45 V	< 55 V	< 80 V
Protection level on output side unsym., input 1 kV/μs, typ.	< 25 V	< 45 V	< 55 V	< 80 V
input 8/20 μs, typ.	< 12 V	< 25 V	< 30 V	< 40 V
Rated current	< 25 V	< 50 V	< 50 V	< 60 V
	350 mA	300 mA	300 mA	300 mA
<b>Ordering data</b>				
Without signaling contact/function indicator Type	VSPC 4SL 5VDC 0.5A	VSPC 4SL 12VDC 0.5A	VSPC 4SL 12VAC 0.5A	VSPC 4SL 24VDC 0.5A
Order No.	<b>8924200000</b>	<b>8924220000</b>	<b>8924240000</b>	<b>8924320000</b>
With signaling contact/function indicator Type	VSPC 4SL 5VDC 0.5A R	VSPC 4SL 12VDC 0.5A R		VSPC 4SL 24VDC 0.5A R
Order No.	<b>8951570000</b>	<b>8951580000</b>		<b>8951590000</b>
Qty.	1 piece	1 piece	1 piece	1 piece
<b>Note</b>				

Ordering data	VSPC 4SL 24 V AC	VSPC 4SL 48 V AC	VSPC 4SL 60 V AC
Rated voltage U <sub>n</sub>	24 V AC / 34 V DC	48 V AC / 68 V DC	60 V AC / 85 V DC
Max. continuous voltage U <sub>c</sub>	28 V AC / 39 V DC	60 V AC / 85 V DC	72 V AC / 101 V DC
Signaling contact	U <sub>n</sub> 250 V AC 0.1 A 1CO at VSPC R with VSPC CONTROL UNIT	no	no
Optical function indicator (VSPC R)	green = OK; red = arrester faulty, replace	green = OK; red = arrester faulty, replace	green = OK; red = arrester faulty, replace
Transmission test (-3dB)	750 KHz	750 KHz	750 KHz
Impulse reset tested	40 ms	60 ms	60 ms
Residual voltage U <sub>r</sub>	acc. to IEC61643-21	acc. to IEC61643-21	acc. to IEC61643-21
wire-wire / wire-PE / GND-PE	< 60 V	< 125 V	< 165 V
Protection level on output side sym., input 1 kV/μs, typ.	80 V / 60 V / 60 V	80 V / 125 V / 125 V	80 V / 165 V / 165 V
input 8/20 μs, typ.	< 110 V	< 210 V	< 280 V
Protection level on output side unsym., input 1 kV/μs, typ.	< 80 V	< 80 V	< 80 V
input 8/20 μs, typ.	< 60 V	< 85 V	< 100 V
Rated current	< 60 V	< 125 V	< 165 V
	300 mA	250 mA	200 mA
<b>Ordering data</b>			
Without signaling contact/function indicator Type	VSPC 4SL 24VAC 0.5A	VSPC 4SL 48VAC 0.5A	VSPC 4SL 60VAC 0.5A
Order No.	<b>8924340000</b>	<b>8924360000</b>	<b>8924380000</b>
With signaling contact/function indicator Type	VSPC 4SL 24VAC 0.5A R		
Order No.	<b>8951600000</b>		
Qty.	1 piece	1 piece	1 piece
<b>Note</b>			

## VARITECTOR SPC

### VSPC 4SL WIRE – 3/4 conductor, measurement

- Pluggable arrester (plug-in / disconnect interruption-free and impedance neutral)
- Protection of measuring bridge signals
- Testable with V-TEST instrument
- Usable in accordance with installations standard IEC 62305
- Integrated PE contact in base element, safely discharges up to 20 kA (8/20 μs) and 2.5 kA (10/350 μs) to PE



B

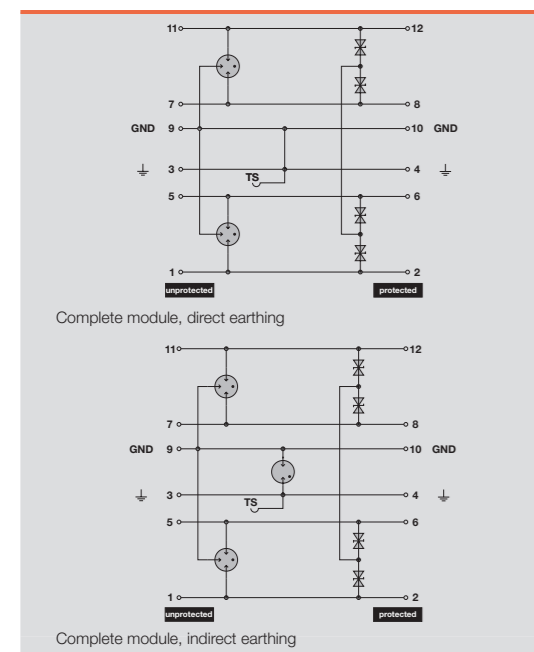

### Technical data

for all VSPC 4SL WIRE	
Rated current	450 mA
Volume resistivity per path	0.2 Ω
Overstressed fault mode	Mode 2
Requirement category acc. to IEC 61643-21	C1; C2; C3; D1
Surge strength C1	< 1 kA / 8/20 μs
Surge strength C2	5 kA / 8/20 μs
Surge strength C3	100 A / 10/1000 μs
Surge strength D1	2.5 kA / 10/350 μs
Rated discharge current $I_{n1}$ (8/20 μs) wire-wire / wire-PE / GND-PE	2.5 kA / 2.5 kA / 2.5 kA
Rated discharge current $I_{n2}$ (8/20 μs) wire-wire / wire-PE / GND-PE	10 kA / 10 kA / 10 kA
Lightning test current $I_{imp}$ (10/350 μs) wire-wire / wire-PE / GND-PE	2.5 kA / 2.5 kA / 2.5 kA
Type of connection	Pluggable in VSPC BASE
Storage temperature	-40 °C...+80 °C
Ambient temperature (operational)	-40 °C...+70 °C
Rel. humidity	5 %...98 % RH
Degree of protection	IP20

Dimensions of complete module (arrester + base element)	Without telecomm. contact	With telecomm. contact (R)
Length x Width x Height	mm 90 x 17.8 x 69	98 x 17.8 x 69

#### Note

### Base elements / base to arresters



### Ordering data for base

Type	Qty.	Order No.
Base element, direct earthing	1	8924740000
Base element, indirect earthing via spark gap (FG, floating ground)	1	8924300000

**Note:** The basis elements are to be ordered separately

VSPC 4SL WIRE – arrester / plug-in elements



B

Ordering data	VSPC 3/4WIRE 5 V DC	VSPC 3/4WIRE 24 V DC
Rated voltage (DC)	3 V DC	24 V DC
Max. continuous voltage, U <sub>c</sub> (DC)	6.4 V DC	28 V DC
Residual voltage U <sub>r</sub>	< 800 V	< 800 V
Transmission test (-3dB)	730 KHz	730 KHz
Impulse reset tested	< 20 ms	< 30 ms
Residual voltage U <sub>r</sub> acc. to IEC61643-21	< 800 V	< 800 V
wire-wire / wire-PE / GND-PE	35 V / 800 V / 500 V	50 V / 800 V / 800 V
Protection level on output side sym., input 1 kV/μs, typ.	< 35 V	< 50 V
input 8/20 μs, typ.	< 35 V	< 50 V
Protection level on output side unsym., input 1 kV/μs, typ.	< 250 V	< 270 V
input 8/20 μs, typ.	< 800 V	< 800 V



Ordering data	VSPC 3/4WIRE 5VDC	VSPC 3/4WIRE 24VDC
Without signaling contact / Type	VSPC 3/4WIRE 5VDC	VSPC 3/4WIRE 24VDC
Function indicator Order No.	<b>8924540000</b>	<b>8924550000</b>
Qty.	1 piece	1 piece
Note		

## VARITECTOR SPC

### VSPC GDT – with components

Pluggable arrester with components: GDT

- Pluggable arrester (plug-in / disconnect interruption-free and impedance neutral)
- Testable with V-TEST instrument
- Integrated PE contact in base element, safely discharges up to 20 kA (8/20 μs) and 2.5 kA (10/350 μs) to PE



B

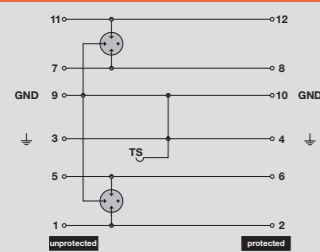

Complete module, direct earthing

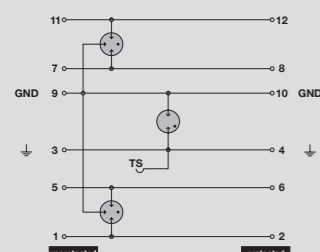

Complete module, indirect earthing

### Technical data

#### for all VSPC GDT

Dielectric strength with FG against PE	> 500 V
Volume resistivity per path	< 0.2 Ω
Overstressed fault mode	Mode 2
Surge strength C1	< 1 kA / 8/20 μs
Surge strength C2	5 kA / 8/20 μs
Surge strength C3	100 A / 10/1000 μs
Surge strength D1	2.5 kA 10/350 μs
Type of connection	Pluggable in VSPC BASE
Storage temperature	-40 °C...+80 °C
Ambient temperature (operational)	-40 °C...+70 °C
Rel. humidity	5 %...96 % RH
Degree of protection	IP20

#### Dimensions of complete module (arrester + base element)

	Without telecomm. contact	With telecomm. contact (R)
Length x Width x Height	mm 90 x 17.8 x 69	98 x 17.8 x 69

#### Note

### Base elements / base to arresters



### Ordering data for base

Type	Qty.	Order No.
Base element, direct earthing	1	8924740000
Base element, indirect earthing via spark gap (FG, floating ground)	1	8924300000

**Note:** The basis elements are to be ordered separately

VSPC GDT – arrester / plug-in elements



B



Ordering data	VSPC GDT 2CH 90 V	VSPC GDT 2CH 150 V AC/230 V DC
Rated voltage (DC)	48 V AC / 68 V DC	110 V AC / 150 V DC
Max. continuous voltage, U <sub>c</sub> (DC)	50 V AC / 72 V DC	125 V AC / 180 V DC
Signaling contact	no	no
Rated current	2000 mA	2000 mA
Transmission test (-3dB)	3 MHz	3 MHz
Impulse reset tested	in accordance with IEC61643-21	in accordance with IEC61643-21
Rated discharge current I <sub>n</sub> (8/20 μs) wire-wire / wire-PE / GND-PE	2 x 2.5 kA / - / 2.5 kA	2 x 2.5 kA / - / 2.5 kA
Rated discharge current I <sub>max</sub> (8/20 μs) wire-wire / wire-PE / GND-PE	2 x 10 kA / - / 10 kA	2 x 10 kA / - / 10 kA
Rated discharge current, I <sub>max</sub> (10/350 μs) wire-wire / wire-PE / GND-PE	2 x 0.2 kA / - / 0.2 kA	2 x 0.2 kA / - / 0.2 kA
Residual voltage U <sub>r</sub> wire-wire / wire-PE / GND-PE	< 1000 V 650 V / 1000 V / -	< 800 V 800 V / 800 V / -
Protection level on output side sym., input 1 kV/μs, typ.	< 650 V	< 450 V
input 8/20 μs, typ.	< 1000 V	< 800 V
Requirement category acc. to IEC 61643-21	C1; C2; C3; D1	C1; C2; C3; D1
<b>Ordering data</b>		
Without signaling contact/function indicator	Type VSPC GDT 2ch 90V20kA	Type VSPC GDT 2CH 150Vac/230Vdc
Order No.	<b>8924570000</b>	<b>8924590000</b>
With signaling contact/function indicator	Type	Type
Order No.		
Qty.	1 piece	1 piece
<b>Note</b>		



## VARITECTOR SPC

### VSPC MOV – with components

Pluggable arrester with components: MOV

- Optional monitoring function with status display and alert function for MOV components
- Pluggable arrester (plug-in / disconnect interruption-free and impedance neutral)
- Testable with V-TEST instrument
- Integrated PE contact in base element, safely discharges up to 20 kA (8/20 μs) and 2.5 kA (10/350 μs) to PE



B

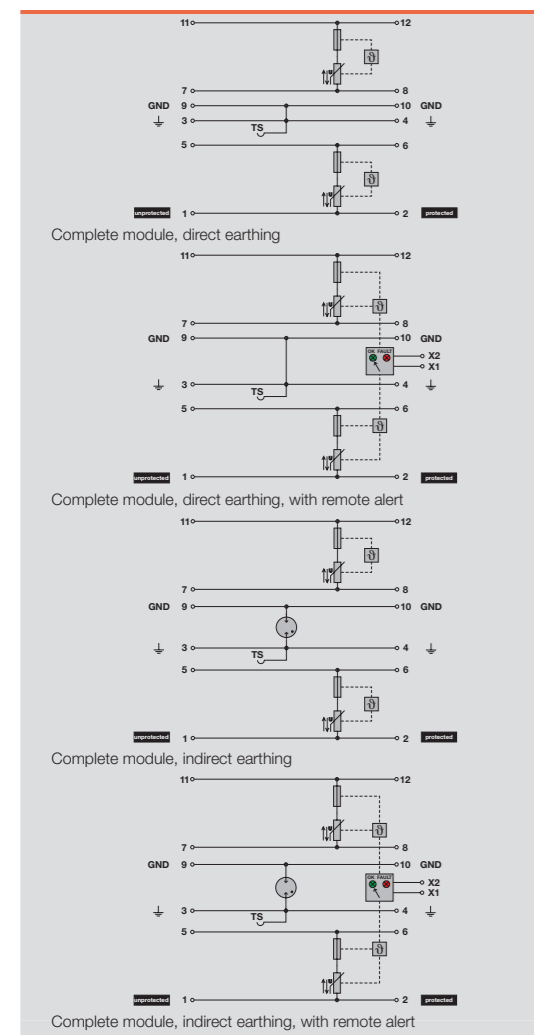

### Technical data

for all VSPC MOV	
Dielectric strength with FG against PE	> 500 V
Volume resistivity per path	< 0.2 Ω
Overstressed fault mode	Mode 1
Surge strength C1	< 1 kA / 8/20 μs
Surge strength C2	1.5 kA / 8/20 μs; 1 kA / 8/20 μs at VSPC R
Surge strength D1	0.5 kA 10/350 μs
Type of connection	Pluggable in VSPC BASE
Storage temperature	-40 °C...+80 °C
Ambient temperature (operational)	-40 °C...+70 °C
Rel. humidity	5 %...96 % RH
Degree of protection	IP20

### Dimensions of complete module (arrester + base element)

	Without telecomm. contact	With telecomm. contact (R)
Length x Width x Height	mm 90 x 17.8 x 69	98 x 17.8 x 69

#### Note

### Base elements / base to arresters



### Ordering data for base

Type	Qty.	Order No.
Base element, direct earthing	1	8924740000
Base element, indirect earthing via spark gap (FG, floating ground)	1	8924300000
Base element, direct earthing with remote alert	1	8951790000
Base element, indirect earthing with remote alert	1	8951800000

**Note:** The basis elements are to be ordered separately

VSPC MOV – arrester / plug-in elements



B



Ordering data	VSPC MOV 2CH 24 V	VSPC MOV 2CH 230 V
Rated voltage (DC)	24 V AC	230 V AC
Max. continuous voltage, U <sub>c</sub> (DC)	30 V AC / 42 V DC	275 V AC / 385 V DC
Rated current	10 A	10 A
Transmission test	1 MHz	1 MHz
tested	acc. to IEC61643-21	acc. to IEC61643-21
Surge strength C3	100 A / 10/1000 μs	50 A / 10/1000 μs
Rated discharge current, I <sub>imp</sub> (10/350 μs)		
wire-wire / wire-PE / GND-PE	0.2 kA / - / 0.5 kA	0.2 kA / - / 0.5 kA
Rated discharge current I <sub>n</sub> (8/20 μs)		
wire-wire / wire-PE / GND-PE	1.5 kA / - / 1.5 kA	1.5 kA / - / 1.5 kA
Rated discharge current I <sub>w</sub> (8/20 μs)		
wire-wire / wire-PE / GND-PE	1.5 kA / - / 1.5 kA	1.5 kA / - / 1.5 kA
Residual voltage U <sub>r</sub>		
wire-wire / wire-PE / GND-PE	< 95 V	< 850 V
Protection level on output side sym.,		
input 1 kV/μs, typ.	< 80 V	< 600 V
input 8/20 μs, typ.	< 95 V	< 700 V
Requirement category acc. to IEC 61643-21	C1; C2; C3; D1	C1; C2; C3; D1
<b>Ordering data</b>		
Without signaling contact/function indicator	Type VSPC MOV 2CH 24V 8kA	Type VSPC MOV 2ch 230V8kA
Order No.	<b>8924600000</b>	<b>8924610000</b>
Qty.	1 piece	1 piece
<b>Note</b>		

Ordering data	VSPC MOV 2CH 24 V R	VSPC MOV 2CH 230 V R
Rated voltage (DC)	24 V AC	230 V AC
Max. continuous voltage, U <sub>c</sub> (DC)	30 V AC / 42 V DC	275 V AC / 385 V DC
Signaling contact	U <sub>n</sub> 250 V AC 0.1 A 1CO at VSPC R with VSPC CONTROL UNIT	U <sub>n</sub> 250 V AC 0.1 A 1CO at VSPC R with VSPC CONTROL UNIT
Optical function indicator (VSPC R)	green = OK; red = arrester faulty, replace	green = OK; red = arrester faulty, replace
Rated current	10 A	10 A
Transmission test	1 MHz	1 MHz
tested	acc. to IEC61643-21	acc. to IEC61643-21
Surge strength C3	100 A / 10/1000 μs	50 A / 10/1000 μs
Rated discharge current, I <sub>imp</sub> (10/350 μs)		
wire-wire / wire-PE / GND-PE	0.2 kA / - / 0.5 kA	0.2 kA / - / 0.5 kA
Rated discharge current I <sub>n</sub> (8/20 μs)		
wire-wire / wire-PE / GND-PE	1 kA / - / 1 kA	1 kA / - / 1 kA
Rated discharge current I <sub>w</sub> (8/20 μs)		
wire-wire / wire-PE / GND-PE	1 kA / - / 1 kA	1 kA / - / 1 kA
Residual voltage U <sub>r</sub>		
wire-wire / wire-PE / GND-PE	< 200 V	< 850 V
Protection level on output side sym.,		
input 1 kV/μs, typ.	< 80 V	< 600 V
input 8/20 μs, typ.	< 95 V	< 700 V
Requirement category acc. to IEC 61643-21	C1; C2; C3; D1	C1; C2; C3; D1
<b>Ordering data</b>		
With signaling contact/function indicator	Type VSPC MOV 2CH 24V R	Type VSPC MOV 2ch 230V R
Order No.	<b>8951650000</b>	<b>8951660000</b>
Qty.	1 piece	1 piece
<b>Note</b>		

**VARITECTOR SPC**

**VSPC TAZ – components**

Pluggable arrester with components: TAZ

- Pluggable arrester (plug-in / disconnect interruption-free and impedance neutral)
- Testable with V-TEST instrument
- Integrated PE contact in base element, safely discharges up to 20 kA (8/20 μs) and 2.5 kA (10/350 μs) to PE



**B**

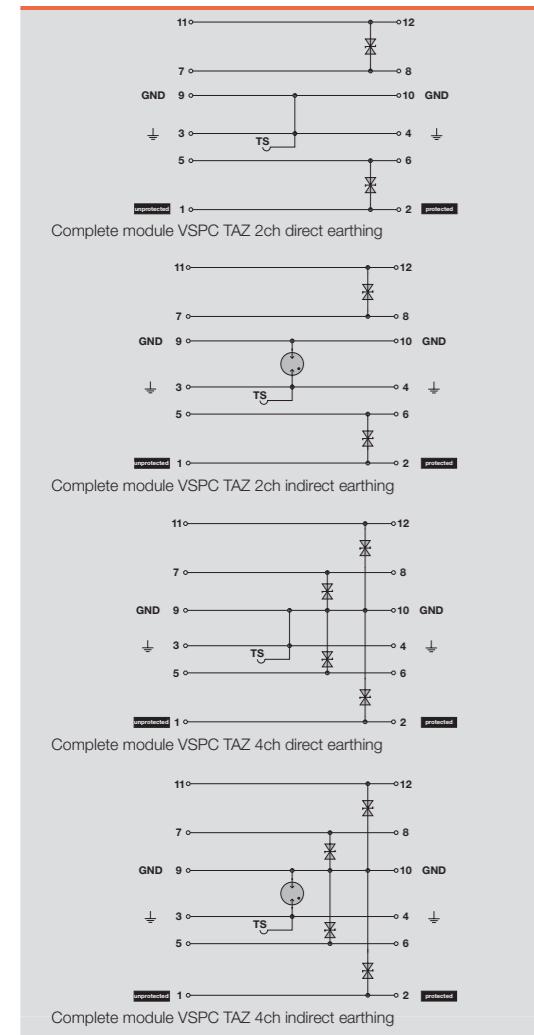

**Technical data**

for all VSPC TAZ	
Dielectric strength with FG against PE	> 500 V
Rated current	10 A
Volume resistivity per path	< 0.2 Ω
Overstressed fault mode	Mode 2
Requirement category acc. to IEC 61643-21	C3
Surge strength C3	20 A / 10/1000 μs
Type of connection	Pluggable in VSPC BASE
Storage temperature	-40 °C...+80 °C
Ambient temperature (operational)	-40 °C...+70 °C
Rel. humidity	5 %...96 % RH
Degree of protection	IP20

Dimensions of complete module (arrester + base element)	Without telecomm. contact	With telecomm. contact (R)
Length x Width x Height	mm 90 x 17,8 x 69	98 x 17,8 x 69

**Note**

**Base elements / base to arresters**



**Ordering data for base**

Type	Qty.	Order No.
Base element, direct earthing	1	8924740000
Base element, indirect earthing via spark gap (FG, floating ground)	1	8924300000

**Note:** The basis elements are to be ordered separately

VSPC TAZ – arrester / plug-in elements



B



Ordering data	VSPC TAZ 2 CH 24 V AC	VSPC TAZ 4 CH 24 V
Rated voltage (DC)	24 V AC / 34 V DC	24 V AC / 34 V DC
Max. continuous voltage, U <sub>c</sub> (DC)	28 V AC / 39 V DC	28 V AC / 39 V DC
Transmission test (-3dB)	1 MHz	1 MHz
Impulse reset tested	in accordance with IEC61643-21	in accordance with IEC61643-21
Residual voltage U <sub>p</sub> wire-wire / wire-PE / GND-PE	55 V / - / -	- / 55 V / -
Protection level on output side sym., input 1 kV/μs, typ.	< 50 V	< 50 V
input 8/20 μs, typ.	< 55 V	< 55 V

Ordering data		
Without signaling contact /	Type	VSPC TAZ 2ch24Vac 0.1kA
Function indicator	Order No.	<b>8924640000</b>
	Qty.	1 piece
		VSPC TAZ 4ch24V 0.1kA
		<b>8924650000</b>
		1 piece
Note		

**VARITECTOR SPC**

**VSPC TELE UK0**

for the U<sub>10</sub>/S<sub>3</sub> interface in telecommunication

- Pluggable arrester (plug-in / disconnect interruption-free and impedance neutral)
- Low residual voltage
- 2-wire input interface – Uk0
- Testable with V-TEST instrument
- Integrated PE contact in base element, safely discharges up to 20 kA (8/20 µs) and 2.5 kA (10/350 µs) to PE



**B**

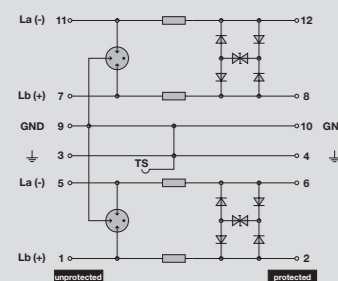

Complete module, direct earthing

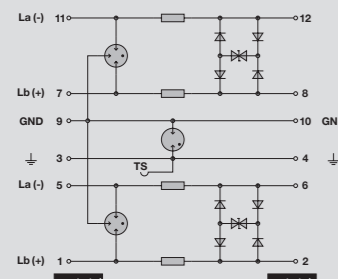

Complete module, indirect earthing

**Technical data**

for all VSPC TELE UK0

Dielectric strength with FG against PE	> 500 V
Rated current	450 mA
Volume resistivity per path	2.2 Ω
Overstressed fault mode	Mode 2
Requirement category acc. to IEC 61643-21	C1; C2; C3; D1
Surge strength C1	< 1 kA / 8/20 µs
Surge strength C2	5 kA / 8/20 µs
Surge strength C3	100 A / 10/1000 µs
Surge strength D1	2.5 kA 10/350 µs
Rated discharge current I <sub>ns</sub> (8/20 µs) wire-wire / wire-PE / GND-PE	2.5 kA / 2.5 kA / 2.5 kA
Rated discharge current I <sub>max</sub> (8/20 µs) wire-wire / wire-PE / GND-PE	10 kA / 2 x 10 kA / 10 kA
Lightning test current I <sub>imp</sub> (10/350 µs) wire-wire / wire-PE / GND-PE	0.2 kA / 2 x 0.2 kA / 0.2 kA
Type of connection	Pluggable in VSPC BASE
Storage temperature	-40 °C...+80 °C
Ambient temperature (operational)	-40 °C...+70 °C
Rel. humidity	5 %...96 % RH
Degree of protection	IP20

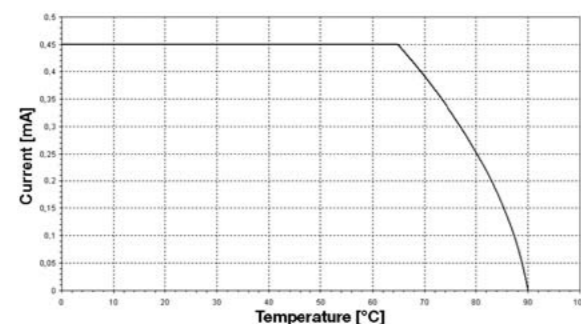

Dimensions of complete module (arrester + base element)	Without telecomm. contact	With telecomm. contact (R)
Length x Width x Height	mm 90 x 17.8 x 69	98 x 17.8 x 69

**Note**

**Base elements / base to arresters**



**Ordering data for base**

Type	Qty.	Order No.
Base element, direct earthing	1	8924710000
Base element, indirect earthing via spark gap (FG, floating ground)	1	8924270000

**Note:** The basis elements are to be ordered separately

VSPC TELE UK0 / VSPC RS485 – arrester / plug-in elements



Ordering data

VSPC TELE UK0 2WIRE

Rated voltage (DC)	127 V AC
Max. continuous voltage, U <sub>c</sub> (DC)	180 V DC
Transmission test (-3dB)	1 MHz
Impulse reset tested	60 ms
Residual voltage U <sub>r</sub> wire-wire / wire-PE / GND-PE	in accordance with IEC61643-21 800 V
Protection level on output side sym., input 1 kV/μs, typ.	250 V / 450 V / 650 V
Protection level on output side unsym., input 8/20 μs, typ.	< 250 V
Protection level on output side unsym., input 1 kV/μs, typ.	< 300 V
Protection level on output side unsym., input 8/20 μs, typ.	< 450 V
	< 800 V

Ordering data

Without signaling contact /	Type
Function indicator	Order No.
	Qty.

VSPC TELE UK0 2WIRE  
**8924660000**

1 piece

Note

B





**VARITECTOR SPC**

**VSPC RS485**

- For serial data transmission
- Optional monitoring function with status indicator and alert function
  - Pluggable arrester (plug-in / disconnect interruption-free and impedance neutral)
  - Low residual voltage
  - Protection for conducted serial data transmission – RS485
  - Testable with V-TEST instrument
  - Integrated PE contact in base element, safely discharges up to 20 kA (8/20 μs) and 2.5 kA (10/350 μs) to PE

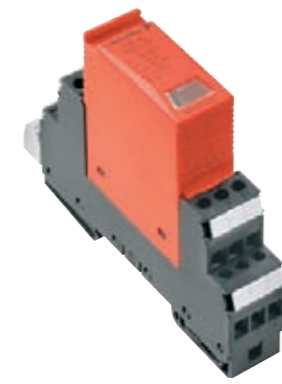

**Technical data**

**for all VSPC RS485**

Dielectric strength with FG against PE	> 500 V
Rated current	450 mA
Volume resistivity per path	2.2 Ω
Overstressed fault mode	Mode 2
Requirement category acc. to IEC 61643-21	C1; C2; C3; D1
Surge strength C1	< 1 kA / 8/20 μs
Surge strength C2	5 kA / 8/20 μs
Surge strength C3	100 A / 10/1000 μs
Surge strength D1	2.5 kA / 10/350 μs
Rated discharge current I <sub>ns</sub> (8/20 μs) wire-wire / wire-PE / GND-PE	2.5 kA / 2.5 kA / 2.5 kA
Rated discharge current I <sub>max</sub> (8/20 μs) wire-wire / wire-PE / GND-PE	10 kA / 2 x 10 kA / 10 kA
Lightning test current I <sub>imp</sub> (10/350 μs) wire-wire / wire-PE / GND-PE	0.2 kA / 2 x 0.2 kA / 0.2 kA
Type of connection	Pluggable in VSPC BASE
Storage temperature	-40 °C...+80 °C
Ambient temperature (operational)	-40 °C...+70 °C
Rel. humidity	5 %...96 % RH
Degree of protection	IP20

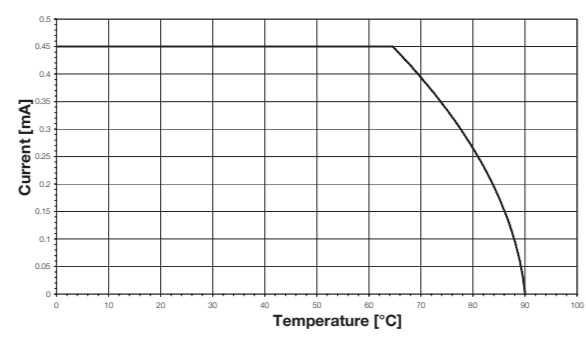
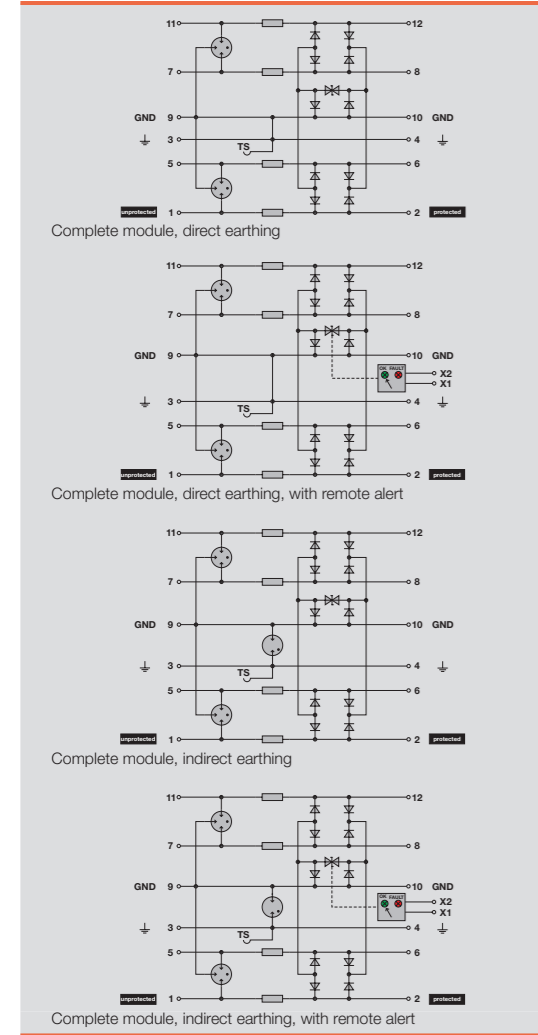

Dimensions of complete module (arrester + base element)	Without telecomm. contact	With telecomm. contact (R)
Length x Width x Height	mm 90 x 17.8 x 69	98 x 17.8 x 69

**Note**

**Base elements / base to arresters**



**Ordering data for base**

Type	Qty.	Order No.
Base element, direct earthing	1	8924710000
Base element, indirect earthing via spark gap (FG, floating ground)	1	8924270000
Base element, direct earthing with remote alert	1	8951790000
Base element, indirect earthing with remote alert	1	8951800000

**Note:** The basis elements are to be ordered separately

VSPC RS485 – arrester / plug-in elements



Ordering data		VSPC RS485 2CH
Rated voltage (DC)		5 V DC
Max. continuous voltage, U <sub>c</sub> (DC)		6,4 V DC
Signaling contact		U <sub>ic</sub> 250 V AC 0,1 A 1CO at VSPC R with VSPC CONTROL UNIT green = OK; red = arrester faulty, replace
Optical function indicator (VSPC R)		4 MHz
Transmission test (-3dB)		20 ms
Impulse reset tested		acc. to IEC61643-21
Residual voltage U <sub>r</sub>		35 V
wire-wire / wire-PE / GND-PE		15 V / 35 V / 500 V
Protection level on output side sym., input 1 kV/μs, typ.		< 10 V
input 8/20 μs, typ.		< 15 V
Protection level on output side unsym., input 1 kV/μs, typ.		< 10 V
input 8/20 μs, typ.		< 35 V
<b>Ordering data</b>		
Without signaling contact /	Type	VSPC RS485 2CH
Function indicator	Order No.	<b>8924670000</b>
With signaling contact /	Type	VSPC RS485 2CH R
Function indicator	Order No.	<b>8951670000</b>
	Qty.	1 piece
<b>Note</b>		

B



**VARITECTOR SPC**

**VSPC CONTROL UNIT 24 V DC**

- For monitoring up to 10 protective modules
- Signaling module for all VSPCs with status indicator
- Signaling of cable breaks / signal interruptions
- Voltage supply from 18...31 V DC
- Potential-free changeover contact
- Function indicator (red/green LED)



**B**

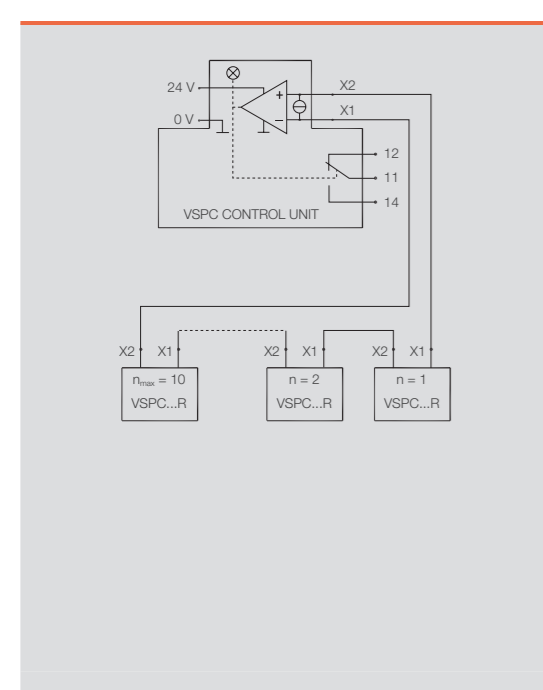

**Technical data**

<b>Input</b>	
Rated voltage (DC)	18 V...24 V DC...31 V DC
Rated current	max. 50 mA
Power rating	1.5 W
<b>Output</b>	
Current loop	8 mA bei < 51 V
Monitoring option	1...10 VSPC modules
<b>Signal output</b>	
Type	1 CO contact
Max. switching voltage / continuous current	250 V / 1 A
<b>Diagnostics</b>	
Operating status	Green LED
Defect at current loop	Red LED (control unit and defective module)
Wire breakage	Red/green LED, flashing
<b>General data</b>	
Terminal rail	TS35
Design, Protection class	Insta-enclosure, IP20
Type of connection	BL / SL
Storage temperature	-40 °C...+80 °C
Ambient temperature (operational)	-40 °C...+70 °C
Rel. humidity	5 %...96 % RH
Start-up time after fault correction	60 s

**Dimensions**

Dimensions incl. enclosure L x W x H	mm	102 x 18 x 71.5
--------------------------------------	----	-----------------

**Note**

**Applikation**

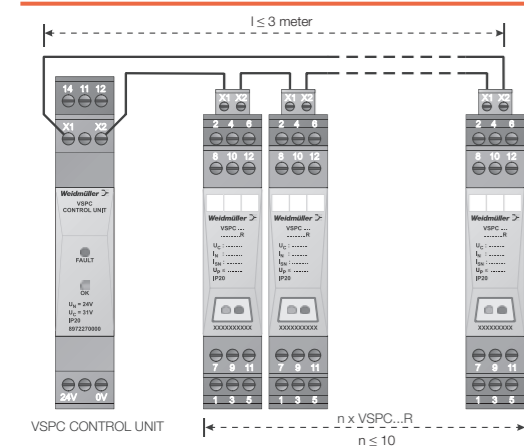

**Status indication**

LED green	LED red	Function
		OK
		FAULT (one/several defect VSPC...R)
		Wire break in monitoring current loop

**Ordering data**

Type	VSPC CONTROL UNIT 24Vdc
Order No.	<b>8972270000</b>
Qty.	1 piece
<b>Note</b>	

**VSPC CONTROL UNIT 24 V DC**

Type	VSPC CONTROL UNIT 24Vdc
Order No.	<b>8972270000</b>
Qty.	1 piece
<b>Note</b>	



**VSPC accessories**

**V-Test**

- Instrument for testing the protective functions of series: PU I, PU II and VSPC
- Device for realising standard IEC 62305 (periodic testing)
- Handy device with integrated battery set for local measurements
- Result display via LCD display
- Bilingual menu
- Including protective bag and power supply
- Intuitive user navigation in German and English

The V-Test is a compact, portable instrument for the Varitector SPC pluggable surge protection (VSPC series) and surge protection for power distribution, PUI and II series. With this instrument, the Weidmüller surge protection can be tested for protective function in accordance with the required test periods as stipulated by IEC62305 (DIN VDE 185 Part 3). In a backlit display, the measurement result is indicated with „ok“ or „not ok“ for each component.



**Technical data**

Rated voltage	100...240 V AC
Accumulator set	8 NiMH with 2800 mAh
Storage temperature	0 °C ... 40 °C
Ambient temperature (operational)	0 °C ... 40 °C
Degree of protection	IP20
Measuring range	U < 1000 V / I = 1 mA
UL94 flammability class	V0

**General tolerances of measurement range**

Gas discharge tube	+/- 10%
Varistor	+/- 5%
TVS-diode	+/- 5%

**Note**

**Ordering data**

<b>Dimensions</b>	
Length x Width x Height	mm
<b>Ordering data</b>	
Type	V-Test
Order No.	8951860000
Qty.	1

**V-Test**

230 x 122 x 65	
V-Test	
8951860000	
1	

**Note**

## VARITECTOR SPC

### VSPC accessories

#### V-Ground

- Can be applied to unassigned wires
- Usable during start-up and maintenance
- Earthing of all sensor cables
- Can be plugged into standard base sockets

#### V-Test-Connector

- Usable during start-up and maintenance
- For circuit voltage measurements using a standard 2.3-mm test socket
- Can be plugged into standard base sockets

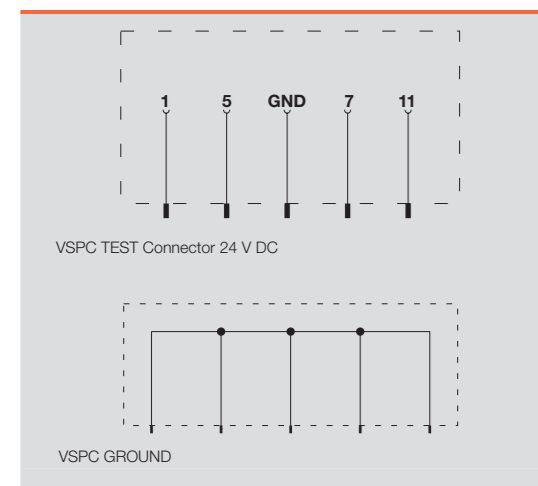

### Technical data

Rated voltage (DC)	230 V AC
Max. continuous voltage, U <sub>c</sub> (DC)	255 V AC
Rated current	< 0.5 A
Volume resistivity per path	< 0.2 Ω
Type of connection	Pluggable in VSPC BASE
Storage temperature	-40 °C...+80 °C
Ambient temperature (operational)	-40 °C...+70 °C
Rel. humidity	5 %...96 % RH
Degree of protection	IP20

#### Note

### Ordering data

Arrester / plug-in elements	Type
	Order No.
	Qty.

#### Note

### VSPC TEST Connector 24 DC

VSPC TEST Connector 24DC
<b>8924690000</b>
1

### VSPC GROUND

VSPC GROUND
<b>8924680000</b>
1



### Ordering data

<b>Shield connection:</b>	Complete set - cable ties and shield connection
	Cable ties
	Shield connection
	Cable tie tool

Type	Qty.	Order No.
EMC set	1	<b>1067470000</b>
EMC tie	100	<b>1067490000</b>
EMC connector	50	<b>1067520000</b>
Cable tie tool RT-1	1	<b>1296000000</b>







**VSPC 1CL EX**  
**Arresters / plugs**

Bases and arresters should be ordered separately

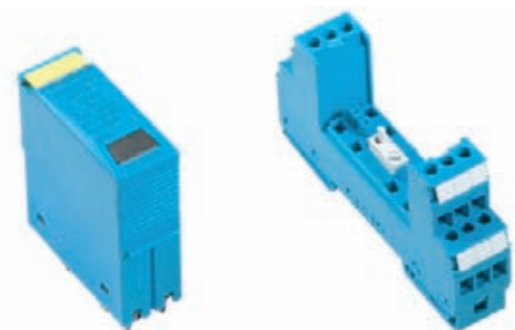

Arrester / plug

Base / socket

**B**



Arrester / plug	VSPC 1CL 5 V DC EX	VSPC 1CL 12 V DC EX	VSPC 1CL 24 V DC EX
<b>Technical data</b>			
Rated voltage (DC)	5 V DC	12 V DC	24 V DC
Max. continuous voltage U <sub>c</sub> (DC)	6.4 V DC	15 V DC	28 V DC
Input voltage, max. U <sub>i</sub>	6 V	14 V	26 V
Signal transmission properties (-3 dB)	730 KHz	730 KHz	730 KHz
Pulse reset capacity	20 ms	20 ms	30 ms
Residual voltage U <sub>r</sub>	< 650 V	< 650 V	< 650 V
wire-wire / wire-PE / GND-PE	12 V / 450 V / 650 V	25 V / 450 V / 650 V	45 V / 450 V / 650 V
Protection level on output side sym.			
Input 1 kV/μs, typ.	< 12 V	< 25 V	< 45 V
Input 8/20 μs, typ.	< 12 V	< 25 V	< 45 V
Protection level on output side unsym.,			
Input 1 kV/μs, typ.	< 450 V	< 450 V	< 450 V
Input 8/20 μs, typ.	< 650 V	< 650 V	< 650 V
Standards	IEC61643-21, IEC 62305, EN 60079-0:2009, EN 60079-11:2007, EN 60079-26:2007, EN 61241-11:2006	IEC61643-21, IEC 62305, EN 60079-0:2009, EN 60079-11:2007, EN 60079-26:2007, EN 61241-11:2006	IEC61643-21, IEC 62305, EN 60079-0:2009, EN 60079-11:2007, EN 60079-26:2007, EN 61241-11:2006
<b>Note</b>			

Ordering data			
<b>Arrester / plug</b>			
Type	VSPC 1CL 5VDC ATEX	VSPC 1CL 12VDC ATEX	VSPC 1CL 24VDC ATEX
Order No.	<b>8953660000</b>	<b>8953590000</b>	<b>8953600000</b>
Qty.	1	1	1
<b>Note</b>			

Base / socket	VSPC BASE 1CL FG EX	VSPC BASE 1CL FG EX	VSPC BASE 1CL FG EX
<b>Technical data</b>			
Clamping range			
Rated connection, min./max.	0.5 mm <sup>2</sup> / 4 mm <sup>2</sup>	0.5 mm <sup>2</sup> / 4 mm <sup>2</sup>	0.5 mm <sup>2</sup> / 4 mm <sup>2</sup>
Conductor cross section,			
flexible, min./max.	0.5 mm <sup>2</sup> / 2.5 mm <sup>2</sup>	0.5 mm <sup>2</sup> / 2.5 mm <sup>2</sup>	0.5 mm <sup>2</sup> / 2.5 mm <sup>2</sup>
solid, min./max.	0.5 mm <sup>2</sup> / 4 mm <sup>2</sup>	0.5 mm <sup>2</sup> / 4 mm <sup>2</sup>	0.5 mm <sup>2</sup> / 4 mm <sup>2</sup>
stranded, min./max.	0.5 mm <sup>2</sup> / 2.5 mm <sup>2</sup>	0.5 mm <sup>2</sup> / 2.5 mm <sup>2</sup>	0.5 mm <sup>2</sup> / 2.5 mm <sup>2</sup>
Stripping length	7 mm	7 mm	7 mm
Tightening torque	0.5...0.8 Nm	0.5...0.8 Nm	0.5...0.8 Nm
<b>Note</b>			

Ordering data			
<b>Base / socket</b>			
Indirect earthing via gas discharged tube FG, floating ground	Type	VSPC BASE 1CL FG EX	VSPC BASE 1CL FG EX
Order No.		<b>8951810000</b>	<b>8951810000</b>
Qty.		1	1
<b>Size of complete module (arrester + base)</b>			
Length x width x height		90 x 17.8 x 69 mm	90 x 17.8 x 69 mm
<b>Note:</b>	Accessories: Screwdrivers SD 0.6x3.5x200 Order No.: <b>9010110000</b>	Accessories: Screwdrivers SD 0.6x3.5x200 Order No.: <b>9010110000</b>	Accessories: Screwdrivers SD 0.6x3.5x200 Order No.: <b>9010110000</b>



**VSPC 2CL EX**  
**Arresters / plugs**

Bases and arresters should be ordered separately



Arrester / plug



Base / socket

**B**



Arrester / plug	VSPC 2CL 24 V DC EX
<b>Technical data</b>	
Rated voltage (DC)	24 V DC
Max. continuous voltage U <sub>c</sub> (DC)	28 V DC
Input voltage, max. U <sub>i</sub>	26 V
Signal transmission properties (-3 dB)	2.2 MHz
Pulse reset capacity	30 ms
Residual voltage U <sub>r</sub>	< 800 V
wire-wire / wire-PE / GND-PE	45 V / 450 V / 800 V
Protection level on output side sym.	
Input 1 kV/μs, typ.	< 45 V
Input 8/20 μs, typ.	< 45 V
Protection level on output side unsym.,	
Input 1 kV/μs, typ.	< 450 V
Input 8/20 μs, typ.	< 800 V
Standards	IEC61643-21, IEC 62305, EN 60079-0:2009, EN 60079-11:2007, EN 60079-26:2007, EN 61241-11:2009
<b>Note</b>	

Ordering data	
<b>Arrester / plug</b>	
Type	VSPC 2CL 24VDC ATEX
Order No.	<b>8953720000</b>
Qty.	1
<b>Note</b>	

Base / socket	VSPC BASE 2CL FG EX
<b>Technical data</b>	
Clamping range,	
Rated connection, min./max.	0.5 mm <sup>2</sup> / 4 mm <sup>2</sup>
Conductor cross section,	
flexible, min./max.	0.5 mm <sup>2</sup> / 2.5 mm <sup>2</sup>
solid, min./max.	0.5 mm <sup>2</sup> / 4 mm <sup>2</sup>
stranded, min./max.	0.5 mm <sup>2</sup> / 2.5 mm <sup>2</sup>
Stripping length	7 mm
Tightening torque	0.5...0.8 Nm
<b>Note</b>	

Ordering data	
<b>Base / socket</b>	
Indirect earthing via gas discharged tube FG, floating ground	Type VSPC BASE 2CL FG EX
Order No.	<b>8951820000</b>
Qty.	1
<b>Size of complete module (arrester + base)</b>	
Length x width x height	90 x 17.8 x 69 mm
<b>Note:</b>	Accessories: Screwdrivers SD 0.6x3.5x200 Order No.: <b>9010110000</b>

**VARITECTOR SPC EX**

**VSPC 1CL PW EX – combinations of current-loop signal and device protection in intrinsically safe circuits**

- Pluggable arrester (impedance neutral plugging/unplugging without interruption)
- Can be used to comply with the IEC 62305 installation standard
- Integrated PE contact in base element, safely discharges up to 20 kA (8/20 μs) and 2.5 kA (10/350 μs) to PE
- Can be used in zone 2, 1 and 0
- Certified for IEC 61643-21:08 D1, C1, C2, C3
- Certified for IEC 61643-11:09 class III



**Technical data arresters / plugs**

Protection for the current loop	
Rated voltage (DC)	24 V AC / 34 V DC
Max. continuous voltage U <sub>c</sub> (DC)	27 V AC / 38 V DC
Spannungsfestigkeit bei FG gegen PE	> 500 V
Volume resistivity	2.2 Ω
Overstressed fault mode	Mode 2
Requirement category acc. to IEC 61643-21	C1; C2; C3; D1
Rated voltage (AC/DC)	24 V AC / 33 V DC
Surge strength C1	< 1 kA / 8/20 μs
Surge strength C2	5 kA / 8/20 μs
Surge strength C3	100 A / 10/1000 μs
Surge strength D1	2.5 kA / 10/350 μs
Signal transmission properties (-3 dB)	730 KHz
Pulse reset capacity	10 ms
Rated discharge current I <sub>n</sub> (8/20 μs) wire-wire / wire-PE / GND-PE	2.5 kA / 2.5 kA / 2.5 kA
Rated discharge current I <sub>m</sub> (8/20 μs) wire-wire / wire-PE / GND-PE	10 kA / 10 kA / 10 kA
Lightning test current, I <sub>imp</sub> (10/350 μs) wire-wire / wire-PE / GND-PE	2.5 kA / 2.5 kA / 2.5 kA
Residual voltage U <sub>p</sub>	800 V
Residual voltage U <sub>p</sub> wire-wire / wire-PE / GND-PE	60 V / 450 V / 800 V
Protection level on output side sym., input 1 kV/μs, typ.	< 60 V
Protection level on output side sym., input 8/20 μs, typ.	< 60 V
Protection level on output side unsym., input 1 kV/μs, typ.	< 450 V
Protection level on output side unsym., input 8/20 μs, typ.	< 800 V
Standards	IEC 61643-21, IEC 61643-1, IEC 62305, EN 60079-0:2009, EN 60079-11:2007, EN 60079-26:2007, EN 61241-11:2009
Protection for Energy line III	
Rated voltage (DC)	24 V AC / 34 V DC
Max. continuous voltage U <sub>c</sub> (AC) / (DC)	27 V AC / 38 V DC
Combined pulse	6 kV
Residual voltage U <sub>c</sub>	900 V
Nominal current	0.35 A

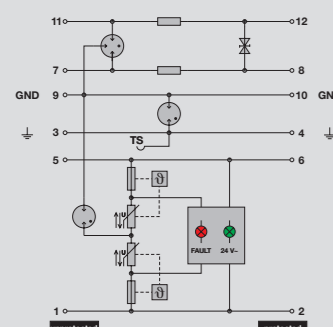

Complete module, floating ground

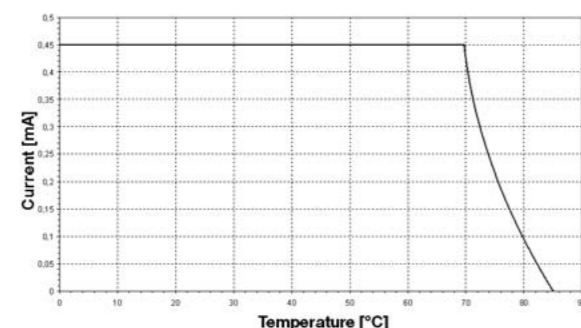

Note

ATEX Approval:  
 Ⓢ II 1 G EX ia IIC T4...T6 Ga  
 Ⓢ II 1 D Ex ia IIIIC T135°C...T85°C Da  
 EU-type examination certificate No.: KEMA 10ATEX0148 X

**VSPC 1CL PW EX**

**Arresters / plugs**

Bases and arresters should be ordered separately



Arrester / plug



Base / socket

**B**



**Arrester / plug**

Technical data	
Type of connection	Pluggable in VSPC BASE
Ambient temperature (operational)	-40 °C...+70 °C
Storage temperature	-40 °C...+80 °C
Requirement category acc. to IEC 61643-1	Class III
Rel. humidity	5 %...96 % RH
EX protection data	
Degree of protection	IP20
Flammability class	V0
Inner capacitance, max. Ci	< 4 nF
Inner inductance, max. Li	0 µH
Temperature class T6/85°C (-40°C...+60°C) II	250 mA
Temperature class T5/100°C (-40°C...+75°C) II	250 mA
Temperature class T4/135°C (-40°C...+85°C) II	350 mA
Input power, max. Pi	3 W
Input voltage, max. Ui	20 V
Failure probability	
λ <sub>2005</sub>	45
MTTF	2537 years
Note	

**VSPC 1CL PW 24 V EX**

Type	VSPC 1CL PW 24V 0,5A
Order No.	<b>8951510000</b>
Qty.	1
Note	

**Ordering data**

Arrester / plug	
Type	VSPC 1CL PW 24V 0,5A
Order No.	<b>8951510000</b>
Qty.	1
Note	

**Base / socket**

Technical data	
Clamping range	
Rated connection, min./max.	0.5 mm <sup>2</sup> / 4 mm <sup>2</sup>
Conductor cross section, flexible, min./max.	0.5 mm <sup>2</sup> / 2.5 mm <sup>2</sup>
solid, min./max.	0.5 mm <sup>2</sup> / 4 mm <sup>2</sup>
stranded, min./max.	0.5 mm <sup>2</sup> / 2.5 mm <sup>2</sup>
Stripping length	7 mm
Tightening torque	0.5...0.8 Nm
Note	

**VSPC BASE 1CL PW FG EX**

Type	VSPC BASE 1CL PW FG EX
Order No.	<b>1070470000</b>
Qty.	1
Note	

**Ordering data**

Base / socket	
Indirect earthing via gas discharged tube FG, floating ground	Type
Order No.	VSPC BASE 1CL PW FG EX
Qty.	<b>1070470000</b>
Qty.	1
Size of complete module (arrester + base)	
Length x width x height	90 x 17.8 x 69 mm
Note:	

Accessories: Screwdrivers	SD 0.6x3.5x200 Order No.: <b>9010110000</b>
---------------------------	---





**VARITECTOR SPC EX**

Surge protection  
Innovations 2010/2011

**VSPC 2SL EX**  
**Arresters / plugs**

Bases and arresters should be ordered separately

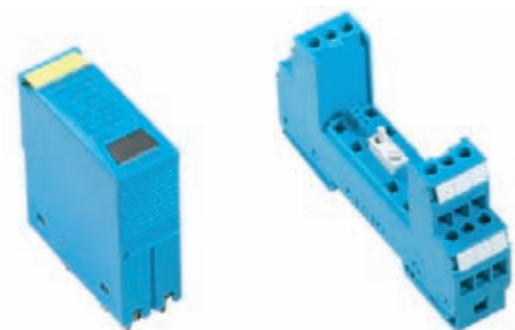

Arrester / plug

Base / socket

**B**



Arrester / plug	VSPC 2SL 12 V DC EX	VSPC 2SL 12 V AC EX	VSPC 2SL 24 V DC EX	VSPC 2SL 48 V AC EX
<b>Technical data</b>				
Rated voltage U <sub>n</sub>	12 V DC	12 V AC / 16 V DC	24 V DC	48 V AC / 68 V DC
Max. continuous voltage U <sub>c</sub> (AC) / (DC)	15 V DC	13.2 V AC / 18 V DC	28 V DC	60 V AC / 85 V DC
Input voltage, max. U <sub>i</sub>	14 V	19 V	26 V	75 V
Temperature class T4/135°C (-40°C...+85°C) II	300 mA	300 mA	300 mA	250 mA
Signal transmission properties (-3 dB)	750 KHz	750 KHz	750 KHz	750 KHz
Pulse reset capacity	20 ms	20 ms	30 ms	60 ms
Standards	IEC 61643-21, IEC 62305, EN 60079-0:2009, EN 60079-11:2007, EN 60079-26:2007, EN 61241-11:2009	IEC 61643-21, IEC 62305, EN 60079-0:2009, EN 60079-11:2007, EN 60079-26:2007, EN 61241-11:2009	IEC 61643-21, IEC 62305, EN 60079-0:2009, EN 60079-11:2007, EN 60079-26:2007, EN 61241-11:2009	IEC 61643-21, IEC 62305, EN 60079-0:2009, EN 60079-11:2007, EN 60079-26:2007, EN 61241-11:2009
Residual voltage U <sub>r</sub> wire-wire / wire-PE / GND-PE	< 50 V 45 V / 50 V / 50 V	< 50 V 55 V / 50 V / 50 V	< 60 V 80 V / 60 V / 60 V	< 125 V 80 V / 125 V / 125 V
Protection level on output side sym.				
Input 1 kV/μs, typ.	< 45 V	< 55 V	< 80 V	< 210 V
Input 8/20 μs, typ.	< 45 V	< 55 V	< 80 V	< 80 V
Protection level on output side unsym.,				
Input 1 kV/μs, typ.	< 25 V	< 30 V	< 40 V	< 85 V
Input 8/20 μs, typ.	< 50 V	< 50 V	< 60 V	< 125 V
Nominal current	300 mA	300 mA	300 mA	250 mA
<b>Note</b>				

Ordering data				
<b>Arrester / plug</b>				
Type	VSPC 2SL 12VDC 0.5A ATEX	VSPC 2SL 12VAC 0.5A ATEX	VSPC 2SL 24VDC 0.5A ATEX	VSPC 2SL 48VAC 0.5A ATEX
Order No.	<b>8953620000</b>	<b>8953630000</b>	<b>8953670000</b>	<b>8953640000</b>
Qty.	1	1	1	1
<b>Note</b>				

Base / socket	VSPC BASE 2SL FG EX	VSPC BASE 2SL FG EX	VSPC BASE 2SL FG EX	VSPC BASE 2SL FG EX
<b>Technical data</b>				
Clamping range				
Rated connection, min./max.	0.5 mm <sup>2</sup> / 4 mm <sup>2</sup>	0.5 mm <sup>2</sup> / 4 mm <sup>2</sup>	0.5 mm <sup>2</sup> / 4 mm <sup>2</sup>	0.5 mm <sup>2</sup> / 4 mm <sup>2</sup>
Conductor cross section,				
flexible, min./max.	0.5 mm <sup>2</sup> / 2.5 mm <sup>2</sup>	0.5 mm <sup>2</sup> / 2.5 mm <sup>2</sup>	0.5 mm <sup>2</sup> / 2.5 mm <sup>2</sup>	0.5 mm <sup>2</sup> / 2.5 mm <sup>2</sup>
solid, min./max.	0.5 mm <sup>2</sup> / 4 mm <sup>2</sup>	0.5 mm <sup>2</sup> / 4 mm <sup>2</sup>	0.5 mm <sup>2</sup> / 4 mm <sup>2</sup>	0.5 mm <sup>2</sup> / 4 mm <sup>2</sup>
stranded, min./max.	0.5 mm <sup>2</sup> / 2.5 mm <sup>2</sup>	0.5 mm <sup>2</sup> / 2.5 mm <sup>2</sup>	0.5 mm <sup>2</sup> / 2.5 mm <sup>2</sup>	0.5 mm <sup>2</sup> / 2.5 mm <sup>2</sup>
Stripping length	7 mm	7 mm	7 mm	7 mm
Tightening torque	0.5...0.8 Nm	0.5...0.8 Nm	0.5...0.8 Nm	0.5...0.8 Nm
<b>Note</b>				

Ordering data				
<b>Base / socket</b>				
Indirect earthing via gas discharged tube FG, floating ground	Type VSPC BASE 2SL FG EX	Type VSPC BASE 2SL FG EX	Type VSPC BASE 2SL FG EX	Type VSPC BASE 2SL FG EX
Order No.	<b>8951830000</b>	<b>8951830000</b>	<b>8951830000</b>	<b>8951830000</b>
Qty.	1	1	1	1
<b>Size of complete module (arrester + base)</b>				
Length x width x height	90 x 17.8 x 69 mm	90 x 17.8 x 69 mm	90 x 17.8 x 69 mm	90 x 17.8 x 69 mm
<b>Note:</b>	Accessories: Screwdrivers SD 0.6x3.5x200 Order No.: <b>9010110000</b>	Accessories: Screwdrivers SD 0.6x3.5x200 Order No.: <b>9010110000</b>	Accessories: Screwdrivers SD 0.6x3.5x200 Order No.: <b>9010110000</b>	Accessories: Screwdrivers SD 0.6x3.5x200 Order No.: <b>9010110000</b>



**VSPC 4SL EX**  
**Arresters / plugs**

Bases and arresters should be ordered separately

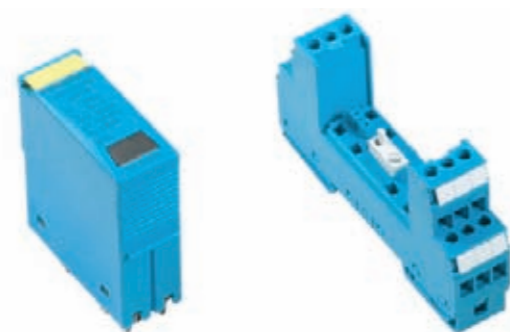

Arrester / plug

Base / socket

**B**

Arrester / plug	VSPC 4SL 12 V DC EX	VSPC 4SL 12 V AC EX	VSPC 4SL 24 V DC EX	VSPC 4SL 24 V AC EX
<b>Technical data</b>				
Rated voltage U <sub>n</sub>	12 V DC	12 V AC / 16 V DC	24 V DC	24 V AC / 34 V DC
Max. continuous voltage U <sub>c</sub> (AC) / (DC)	15 V DC	13.2 V AC / 18 V DC	28 V DC	28 V AC / 39 V DC
Input voltage, max. U <sub>i</sub>	14 V	19 V	26 V	38 V
Signal transmission properties (-3 dB)	750 KHz	750 KHz	750 KHz	750 KHz
Pulse reset capacity	20 ms	20 ms	30 ms	40 ms
Residual voltage U <sub>r</sub>	< 35 V	< 50 V	< 60 V	< 60 V
wire-wire / wire-PE / GND-PE	45 V / 20 V / 450 V	55 V / 50 V / 50 V	80 V / 60 V / 60 V	80 V / 60 V / 60 V
Protection level on output side sym.				
Input 1 kV/μs, typ.	< 45 V	< 55 V	< 80 V	< 110 V
Input 8/20 μs, typ.	< 45 V	< 55 V	< 80 V	< 80 V
Protection level on output side unsym.,				
Input 1 kV/μs, typ.	< 25 V	< 30 V	< 40 V	< 60 V
Input 8/20 μs, typ.	< 50 V	< 50 V	< 60 V	< 60 V
Nominal current	300 mA	300 mA	300 mA	300 mA
Standards	IEC 61643-21, IEC 62305, EN 60079-0:2009, EN 60079-11:2007, EN 60079-26:2007, EN 61241-11:2009	IEC 61643-21, IEC 62305, EN 60079-0:2009, EN 60079-11:2007, EN 60079-26:2007, EN 61241-11:2009	IEC 61643-21, IEC 62305, EN 60079-0:2009, EN 60079-11:2007, EN 60079-26:2007, EN 61241-11:2009	IEC 61643-21, IEC 62305, EN 60079-0:2009, EN 60079-11:2007, EN 60079-26:2007, EN 61241-11:2009
<b>Note</b>				

Ordering data				
<b>Arrester / plug</b>				
Type	VSPC 4SL 12VDC 0.5A ATEX	VSPC 4SL 12VAC 0.5A ATEX	VSPC 4SL 24VDC 0.5A ATEX	VSPC 4SL 24VAC 0.5A ATEX
Order No.	<b>1161170000</b>	<b>1161150000</b>	<b>1161190000</b>	<b>1161180000</b>
Qty.	1	1	1	1
<b>Note</b>				

Base / socket	VSPC BASE 4SL FG EX	VSPC BASE 4SL FG EX	VSPC BASE 4SL FG EX	VSPC BASE 4SL FG EX
<b>Technical data</b>				
Clamping range				
Rated connection, min./max.	0.5 mm <sup>2</sup> / 4 mm <sup>2</sup>	0.5 mm <sup>2</sup> / 4 mm <sup>2</sup>	0.5 mm <sup>2</sup> / 4 mm <sup>2</sup>	0.5 mm <sup>2</sup> / 4 mm <sup>2</sup>
Conductor cross section,				
flexible, min./max.	0.5 mm <sup>2</sup> / 2.5 mm <sup>2</sup>	0.5 mm <sup>2</sup> / 2.5 mm <sup>2</sup>	0.5 mm <sup>2</sup> / 2.5 mm <sup>2</sup>	0.5 mm <sup>2</sup> / 2.5 mm <sup>2</sup>
solid, min./max.	0.5 mm <sup>2</sup> / 4 mm <sup>2</sup>	0.5 mm <sup>2</sup> / 4 mm <sup>2</sup>	0.5 mm <sup>2</sup> / 4 mm <sup>2</sup>	0.5 mm <sup>2</sup> / 4 mm <sup>2</sup>
stranded, min./max.	0.5 mm <sup>2</sup> / 2.5 mm <sup>2</sup>	0.5 mm <sup>2</sup> / 2.5 mm <sup>2</sup>	0.5 mm <sup>2</sup> / 2.5 mm <sup>2</sup>	0.5 mm <sup>2</sup> / 2.5 mm <sup>2</sup>
Stripping length	7 mm	7 mm	7 mm	7 mm
Tightening torque	0.5...0.8 Nm	0.5...0.8 Nm	0.5...0.8 Nm	0.5...0.8 Nm
<b>Note</b>				

Ordering data				
<b>Base / socket</b>				
Indirect earthing via gas discharged tube FG, floating ground	VSPC BASE 4SL FG EX	VSPC BASE 4SL FG EX	VSPC BASE 4SL FG EX	VSPC BASE 4SL FG EX
Order No.	<b>8951840000</b>	<b>8951840000</b>	<b>8951840000</b>	<b>8951840000</b>
Qty.	1	1	1	1
<b>Size of complete module (arrester + base)</b>				
Length x width x height	90 x 17.8 x 69 mm	90 x 17.8 x 69 mm	90 x 17.8 x 69 mm	90 x 17.8 x 69 mm
<b>Note:</b>	Accessories: Screwdrivers SD 0.6x3.5x200 Order No.: <b>9010110000</b>	Accessories: Screwdrivers SD 0.6x3.5x200 Order No.: <b>9010110000</b>	Accessories: Screwdrivers SD 0.6x3.5x200 Order No.: <b>9010110000</b>	Accessories: Screwdrivers SD 0.6x3.5x200 Order No.: <b>9010110000</b>



**VSPC 3/4 WIRE EX**

**Arresters / plugs**

Bases and arresters should be ordered separately



Arrester / plug



Base / socket

**B**



**Arrester / plug**

**VSPC 3/4WIRE 5 V DC EX**

Technical data	
Rated voltage (DC)	3 V DC
Max. continuous voltage U <sub>c</sub> (DC)	6.4 V DC
Signal transmission properties (-3 dB)	730 KHz
Pulse reset capacity	20 ms
Residual voltage U <sub>r</sub>	< 800 V
wire-wire / wire-PE / GND-PE	35 V / 800 V / 500 V
Protection level on output side sym.	
Input 1 kV/µs, typ.	< 35 V
Input 8/20 µs, typ.	< 35 V
Protection level on output side unsym.,	
Input 1 kV/µs, typ.	< 250 V
Input 8/20 µs, typ.	< 800 V
Standards	IEC 61643-21, IEC 62305, EN 60079-0:2009, EN 60079-11:2007, EN 60079-26:2007, EN 61241-11:2009

<b>Note</b>	
-------------	--

**Ordering data**

Arrester / plug	
Type	VSPC 3/4WIRE 5VDC ATEX
Order No.	<b>8953650000</b>
Qty.	1

<b>Note</b>	
-------------	--

**Base / socket**

**VSPC BASE 4SL FG EX**

Technical data	
Clamping range,	
Rated connection, min./max.	0.5 mm <sup>2</sup> / 4 mm <sup>2</sup>
Conductor cross section,	
flexible, min./max.	0.5 mm <sup>2</sup> / 2.5 mm <sup>2</sup>
solid, min./max.	0.5 mm <sup>2</sup> / 4 mm <sup>2</sup>
stranded, min./max.	0.5 mm <sup>2</sup> / 2.5 mm <sup>2</sup>
Stripping length	7 mm
Tightening torque	0.5...0.8 Nm

<b>Note</b>	
-------------	--

**Ordering data**

Base / socket	
Indirect earthing via gas discharged tube FG, floating ground	Type VSPC BASE 4SL FG EX
Order No.	<b>8951840000</b>
Qty.	1

<b>Size of complete module (arrester + base)</b>	
--	--

Length x width x height	90 x 17.8 x 69 mm
-------------------------	-------------------

<b>Note:</b>	Accessories: Screwdrivers SD 0.6x3.5x200 Order No.: <b>9010110000</b>
--------------	--

**VARITECTOR SSC 6AN**

**VSSC 6AN CL and TR CL – protection for analogue signals (CL) with and without disconnect lever (TR)**

Two stage surge protection with screw connection for instrumentation, control and automation technology

- Surge protection in terminal block format
- Modular width of just 6.2 mm
- Space saving design: 1 analogue signal
- Torx® slotted screw connection
- Can be used to comply with the IEC 62305 installation standard and the IEC 61643-1/-22 standards
- Integrated PE contact in base element, safely discharges up to 20 kA (8/20 µs) and 2.5 kA (10/350 µs) to PE

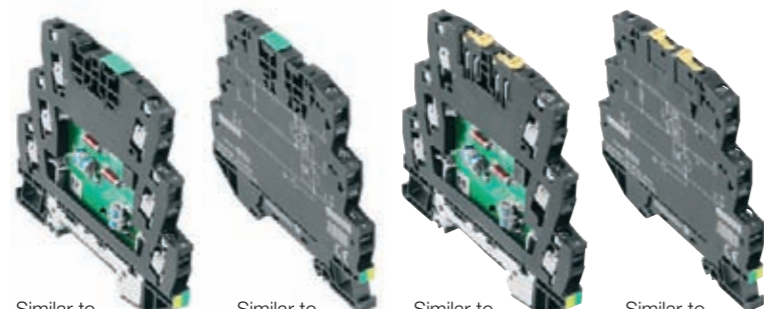

Similar to illustration

Similar to illustration

Similar to illustration

Similar to illustration

**Technical data**

General data	
Nominal current	500 mA (see derating curve)
Dielectric strength at FG against PE	-
Volume resistivity	1.8 Ω ± 10 %
Overstressed fault mode	Mode 2
Requirement category IEC 61643-21	C2; C3; D1
Standards	IEC 61643-21
Surge strength C2	2.5 kA
Surge strength C3	50 A
Surge strength D1	0.5 kA
Rated discharge current $I_n$ (8/20 µs) wire-wire / wire-PE / GND-PE	2.5 kA / 2.5 kA / -
Rated discharge current $I_{max}$ (8/20 µs) wire-wire / wire-PE / GND-PE	5 kA / 5 kA / -
Lightning test current, $I_{imp}$ (10/350 µs) wire-wire / wire-PE / GND-PE	- / 0.5 kA / -
Storage temperature	-40 °C...+80 °C
Ambient temperature (operational)	-40 °C...+70 °C
Humidity	5...96 % RH
Degree of protection	IP20
Flammability class	V0
<hr/>	
Connection	Torx® T15 / slot 0.8 x 4
Tightening torque	0.5 Nm
Conductor cross section, flexible, ferrule (DIN 46228-1), max.	4 mm <sup>2</sup>
Conductor cross section, flexible, ferrule (DIN 46228-1), min.	0.5 mm <sup>2</sup>
Conductor cross section, solid, max.	6 mm <sup>2</sup>
Conductor cross section, solid, min.	0.5 mm <sup>2</sup>
Conductor cross section, stranded, Rated connection, max.	4 mm <sup>2</sup>
Conductor cross section, stranded, Rated connection, min.	0.5 mm <sup>2</sup>
Stripping length	10 mm
Mounting rail	TS35
<hr/>	
Length x width x height	88.5 x 6.2 x 81 mm

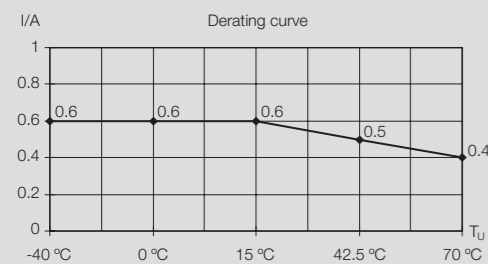
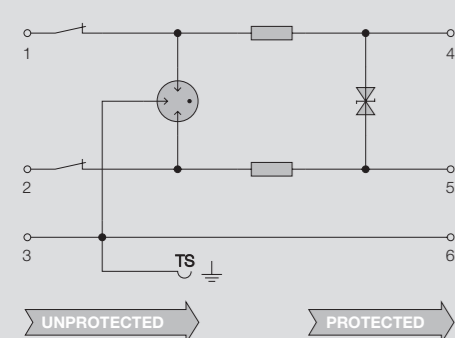
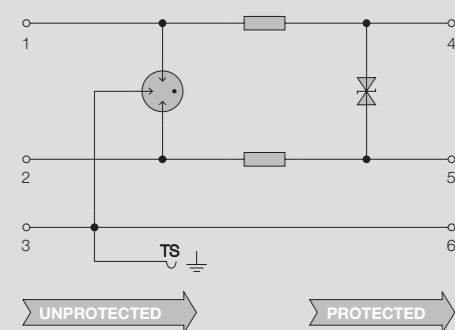

**Accessories:** Screwdriver: Torx® 9009170000, slotted 9008340000; test plug: PS 2.3 0180400000; EMC SET: 1067470000; marker: WS 10/B 1818400000, DEK 6 0468560000, SNAPMARK 1805880000; end plate: 1063110000

VSSC CL and TR CL

Technical data

	CL 12 V DC	CL 24 V UC	CL 48 V UC	CL 60 V UC
Rated voltage AC/DC	12 V DC	24 V AC / 34 V DC	48 V AC / 68 V DC	60 V AC / 85 V DC
Max. continuous voltage $U_c$ (AC) / (DC)	15 V DC	30 V AC / 42 V DC	60 V AC / 85 V DC	75 V AC / 106 V DC
Signal transmission properties (-3 dB)	≤ 700 kHz	≤ 700 kHz	≤ 700 kHz	≤ 700 kHz
Pulse reset capacity	≤ 20 ms	≤ 170 ms	≤ 150 ms	≤ 20 ms
Residual voltage $U_p$	≤ 1600 V	≤ 1650 V	≤ 1510 V	≤ 1520 V
wire-wire / wire-PE / GND-PE	35 V / 900 V / -	90 V / 900 V / -	200 V / 770 V / -	260 V / 780 V / -
Protection level on output side sym., input 1 kV/μs, typ.	30 V	70 V	70 V	200 V
Protection level on output side unsym., input 1 kV/μs, typ.	900 V	900 V	770 V	780 V

Ordering data

Type	VSSC6 CL 12Vdc 0.5A	VSSC6 CL 24Vuc 0.5A	VSSC6 CL 48Vuc 0.5A	VSSC6 CL 60Vuc 0.5A
Order No.	<b>1064150000</b>	<b>1064170000</b>	<b>1064190000</b>	<b>1064210000</b>
Qty.	10 pieces	10 pieces	10 pieces	10 pieces

Note

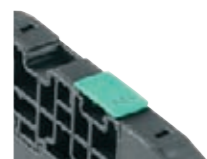

B



Technical data

	TR CL 12 V DC	TR CL 24 V UC	TR CL 48 V UC	TR CL 60 V UC
Rated voltage AC/DC	12 V DC	24 V AC / 34 V DC	48 V AC / 68 V DC	60 V AC / 85 V DC
Max. continuous voltage $U_c$ (AC) / (DC)	15 V DC	30 V AC / 42 V DC	60 V AC / 85 V DC	75 V AC / 106 V DC
Signal transmission properties (-3 dB)	≤ 700 kHz	≤ 700 kHz	≤ 700 kHz	≤ 700 kHz
Pulse reset capacity	≤ 20 ms	≤ 170 ms	≤ 150 ms	≤ 20 ms
Residual voltage $U_p$	≤ 1600 V	≤ 1650 V	≤ 1510 V	≤ 1520 V
wire-wire / wire-PE / GND-PE	35 V / 900 V / -	90 V / 900 V / -	200 V / 770 V / -	260 V / 780 V / -
Protection level on output side sym., input 1 kV/μs, typ.	30 V	70 V	150 V	200 V
Protection level on output side unsym., input 1 kV/μs, typ.	900 V	900 V	770 V	780 V

Ordering data

Type	VSSC6 TR CL 12Vdc 0.5A	VSSC6 TR CL 24Vuc 0.5A	VSSC6 TR CL 48Vuc 0.5A	VSSC6 TR CL 60Vuc 0.5A
Order No.	<b>1064220000</b>	<b>1064230000</b>	<b>1064240000</b>	<b>1064250000</b>
Qty.	10 pieces	10 pieces	10 pieces	10 pieces

Note





**VARITECTOR SSC 6AN**

**VSSC 6AN CLFG and TR CLFG – protection for analogue signals (CL) with floating ground (FG) with and without disconnect lever (TR)**

Two stage surge protection with screw connection for instrumentation, control and automation technology

- Surge protection in terminal-block format
- Modular width of just 6.2 mm
- Space saving design: 1 analogue signal
- Torx® slotted screw connection
- Can be used to comply with the IEC 62305 installation standard and the IEC 61643-1/-22 applications standards.
- Integrated PE contact in base element, safely discharges up to 20 kA (8/20 μs) and 2.5 kA (10/350 μs) to PE
- Version with floating ground PE connection used to avoid differences in voltage potential

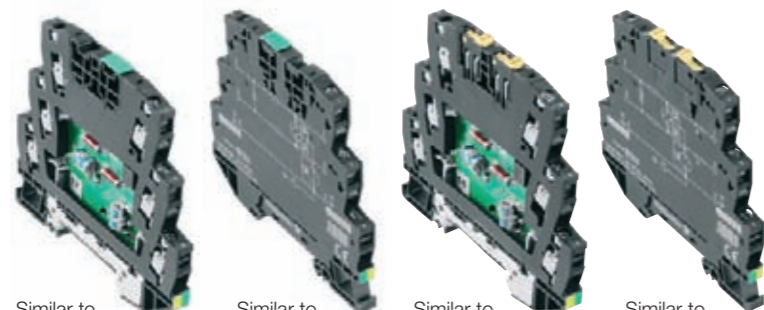

Similar to illustration

Similar to illustration

Similar to illustration

Similar to illustration

**Technical data**

General data	
Nominal current	500 mA (see derating curve)
Dielectric strength at FG against PE	≥ 500 V
Volume resistivity	1.8 Ω ± 10 %
Overstressed fault mode	Mode 2
Requirement category acc. to IEC 61643-21	C2; C3; D1
Standards	IEC 61643-21
Surge strength C2	2.5 kA
Surge strength C3	50 A
Surge strength D1	0.5 kA
Rated discharge current $I_n$ (8/20 μs) wire-wire / wire-PE / GND-PE	2.5 kA / 2.5 kA / –
Rated discharge current $I_{max}$ (8/20 μs) wire-wire / wire-PE / GND-PE	5 kA / 5 kA / –
Lightning test current, $I_{imp}$ (10/350 μs) wire-wire / wire-PE / GND-PE	– / 0.5 kA / –
Storage temperature	-40 °C...+80 °C
Ambient temperature (operational)	-40 °C...+70 °C
Humidity	5...96 % RH
Degree of protection	IP20
Flammability class	V0
Connection data	
Connection	Torx® screw T15 / slot 0.8 x 4
Tightening torque	0.5 Nm
Conductor cross section, flexible, ferrule (DIN 46228-1), max.	4 mm <sup>2</sup>
Conductor cross section, flexible, ferrule (DIN 46228-1), min.	0.5 mm <sup>2</sup>
Conductor cross section, solid, max.	6 mm <sup>2</sup>
Conductor cross section, solid, min.	0.5 mm <sup>2</sup>
Conductor cross section, stranded, Rated connection, max.	4 mm <sup>2</sup>
Conductor cross section, stranded, Rated connection, min.	0.5 mm <sup>2</sup>
Stripping length	10 mm
Mounting rail	TS35
Dimensions	
Length x width x height	88.5 x 6.2 x 81 mm

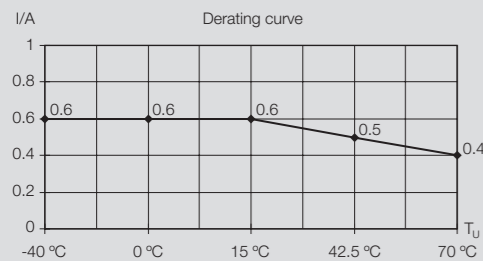
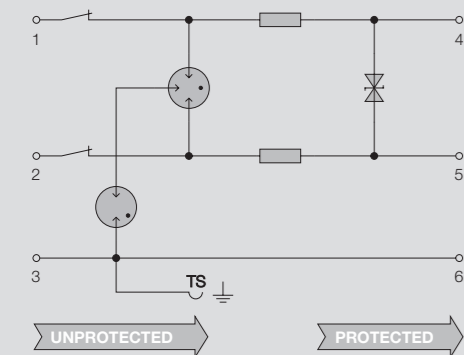
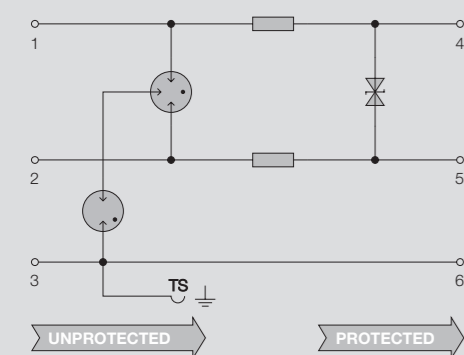

**Accessories:** Screwdriver: Torx® 9009170000, slotted 9008340000; test plug: PS 2.3 0180400000; EMC SET: 1067470000; marker: WS 10/B 1818400000, DEK 6 0468560000, SNAPMARK 1805880000; end plate: 1063110000

VSSC 6AN CLFG and TR CLFG

Technical data

	CLFG 12 V DC	CLFG 24 V UC	CLFG 48 V UC	CLFG 60 V UC
Rated voltage AC/DC	12 V DC	24 V AC / 34 V DC	48 V AC / 68 V DC	60 V AC / 85 V DC
Max. continuous voltage $U_c$ (AC) / (DC)	15 V DC	30 V AC / 42 V DC	60 V AC / 85 V DC	75 V AC / 106 V DC
Signal transmission properties (-3 dB)	$\leq 700$ kHz	$\leq 700$ kHz	$\leq 700$ kHz	$\leq 700$ kHz
Pulse reset capacity	$\leq 20$ ms	$\leq 20$ ms	$\leq 20$ ms	$\leq 20$ ms
Residual voltage $U_p$	$\leq 35$ V	$\leq 85$ V	$\leq 90$ V	$\leq 300$ V
wire-wire / wire-PE / GND-PE	35 V / 1600 V / 800 V	90 V / 1632 V / 800 V	200 V / 1510 V / 800 V	260 V / 1510 V / 800 V
Protection level on output side sym., Input 1 kV/ $\mu$ s, typ.	30 V	70 V	150 V	200 V
Protection level on output side unsym., Input 1 kV/ $\mu$ s, typ.	1600 V	1632 V	1510 V	1510 V

Ordering data

Type	VSSC6 CLFG 12VDC 0.5A	VSSC6 CL FG24VUC 0.5A	VSSC6 CLFG 48VUC 0.5A	VSSC6 CLFG 60VUC 0.5A
Order No.	<b>1064260000</b>	<b>1064270000</b>	<b>1064280000</b>	<b>1064290000</b>
Qty.	10 pieces	10 pieces	10 pieces	10 pieces

Note

Technical data

	TR CLFG 12 V DC	TR CLFG 24 V UC	TR CLFG 48 V UC	TR CLFG 60 V UC
Rated voltage AC/DC	12 V DC	24 V AC / 34 V DC	48 V AC / 68 V DC	60 V AC / 85 V DC
Max. continuous voltage $U_c$ (AC) / (DC)	15 V DC	30 V AC / 42 V DC	60 V AC / 85 V dc	75 V AC / 106 V DC
Signal transmission properties (-3 dB)	$\leq 700$ kHz	$\leq 700$ kHz	$\leq 700$ kHz	$\leq 700$ kHz
Pulse reset capacity	$\leq 20$ ms	$\leq 20$ ms	$\leq 20$ ms	$\leq 20$ ms
Residual voltage $U_p$	$\leq 35$ V	$\leq 85$ V	$\leq 90$ V	$\leq 300$ V
wire-wire / wire-PE / GND-PE	35 V / 1600 V / 800 V	90 V / 1632 V / 800 V	200 V / 1510 V / 800 V	260 V / 1510 V / 800 V
Protection level on output side sym., Input 1 kV/ $\mu$ s, typ.	30 V	70 V	150 V	200 V
Protection level on output side unsym., Input 1 kV/ $\mu$ s, typ.	1600 V	1632 V	1510 V	1510 V

Disconnect lever

Testing option	yes	yes	yes	yes
	Functional screw with test plug receptacle connection 1, 2, 4, 5	Functional screw with test plug receptacle connection 1, 2, 4, 5	Functional screw with test plug receptacle connection 1, 2, 4, 5	Functional screw with test plug receptacle connection 1, 2, 4, 5

Ordering data

Type	VSSC6 TR CLFG 12Vdc0.5	VSSC6TR CLFG 24VUC 0.5A	VSSC6 TR CLFG 48VUC 0.5A	VSSC6 TR CLFG 60VUC 0.5A
Order No.	<b>1064300000</b>	<b>1064310000</b>	<b>1064320000</b>	<b>1064330000</b>
Qty.	10 pieces	10 pieces	10 pieces	10 pieces

Note

B



**VARITECTOR SSC 6AN**

**VSSC 6AN SL and TR SL – protection for binary signals (SL) with and without disconnect lever (TR) and indicator (LD)**

Two-stage surge protection with screw connection for instrumentation, control and automation technology

- Surge protection in terminal-block format
- Modular width of just 6.2 mm
- Space saving design: 2 binary signals
- Torx® slotted screw connection
- Can be used to comply with the IEC 62305 installation standard and the IEC 61643-1/-22 applications standards
- Integrated PE contact in base element, safely discharges up to 20 kA (8/20 μs) and 2.5 kA (10/350 μs) to PE

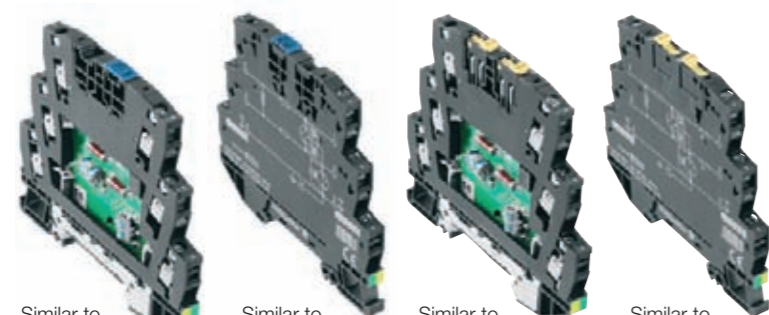

Similar to illustration    Similar to illustration    Similar to illustration    Similar to illustration

**Technical data**

General data	
Nominal current	500 mA (see derating curve)
Dielectric strength at FG against PE	-
Volume resistivity	1.8 Ω ± 10 %
Overstressed fault mode	Mode 2
Requirement category acc. to IEC 61643-21	C2; C3; D1
Standards	IEC 61643-21
Surge strength C2	2.5 kA
Surge strength D1	1 kA
Rated discharge current $I_n$ (8/20 μs) wire-wire / wire-PE / GND-PE	- / 2.5 kA / -
Rated discharge current $I_{max}$ (8/20 μs) wire-wire / wire-PE / GND-PE	- / 10 kA / -
Lightning test current, $I_{imp}$ (10/350 μs) wire-wire / wire-PE / GND-PE	- / 1 kA / -
Storage temperature	-40 °C...+80 °C
Ambient temperature (operational)	-40 °C...+70 °C
Humidity	5...96 % RH
Degree of protection	IP20
Flammability class	V0
Connection data	
Connection	Torx® screw T15 / slot 0.8 x 4
Tightening torque	0.5 Nm
Conductor cross section, flexible, ferrule (DIN 46228-1), max.	4 mm <sup>2</sup>
Conductor cross section, flexible, ferrule (DIN 46228-1), min.	0.5 mm <sup>2</sup>
Conductor cross section, solid, max.	6 mm <sup>2</sup>
Conductor cross section, solid, min.	0.5 mm <sup>2</sup>
Conductor cross section, stranded, Rated connection, max.	4 mm <sup>2</sup>
Conductor cross section, stranded, Rated connection, min.	0.5 mm <sup>2</sup>
Stripping length	10 mm
Mounting rail	TS35
Dimensions	
Length x width x height	88.5 x 6.1 x 81 mm

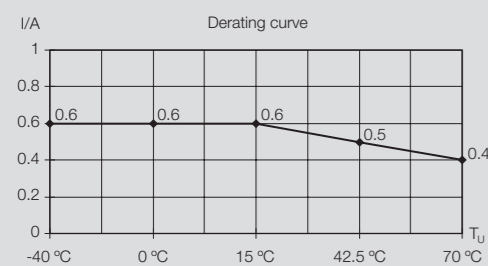
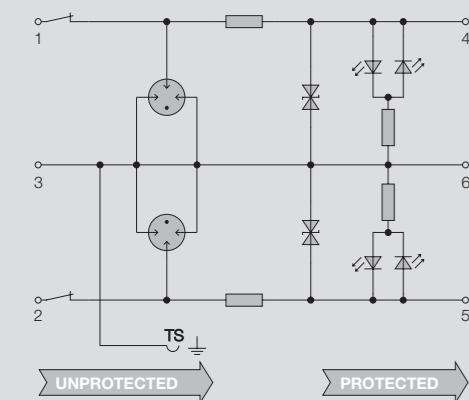
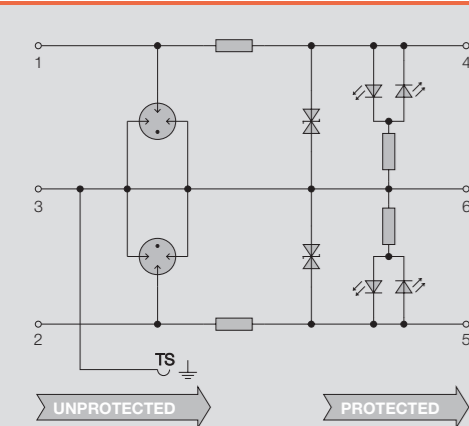

**Accessories:** Screwdriver: Torx® 9009170000, slotted 9008340000; test plug: PS 2.3 0180400000; EMC SET: 1067470000; marker: WS 10/6 1818400000, DEK 6 0468560000, SNAPMARK 1805880000; end plate: 1063110000

VSSC 6AN SL and TR SL

Technical data

	SL LD 12 V DC	SL LD 24 V UC	SL LD 48 V UC	SL LD 60 V UC
Rated voltage AC/DC	12 V DC	24 V AC / 34 V DC	48 V AC / 68 V DC	60 V AC / 85 V DC
Max. continuous voltage U <sub>c</sub> (AC) / (DC)	15 V DC	30 V AC / 42 V DC	60 V AC / 85 V DC	75 V AC / 106 V DC
Signal transmission properties (-3 dB)	≤ 700 kHz	≤ 700 kHz	≤ 700 kHz	≤ 700 kHz
Pulse reset capacity	≤ 30 ms	≤ 30 ms	≤ 30 ms	≤ 30 ms
Residual voltage U <sub>r</sub>	≤ 40 V	≤ 100 V	≤ 220 V	≤ 330 V
wire-wire / wire-PE / GND-PE	- / 74 V / -	- / 110 V / -	- / 175 V / -	- / 230 V / -
Protection level on output side sym.	-	-	-	-
Input 1 kV/μs, typ.	-	-	-	-
Protection level on output side unsym., Input 1 kV/μs, typ.	74 V	110 V	175 V	230 V
Surge strength C3	10 A	50 A	50 A	50 A
Status indicator	Yes	Yes	Yes	Yes

Ordering data

Type	VSSC6 SL LD 12VDC 0.5A	VSSC6 SL LD 24VUC 0.5A	VSSC6 SL LD 48VUC 0.5A	VSSC6 SL LD 60VUC 0.5A
Order No.	<b>1064340000</b>	<b>1064350000</b>	<b>1064360000</b>	<b>1064370000</b>
Qty.	10 pieces	10 pieces	10 pieces	10 pieces

Note



B



Technical data

	TR SL LD 12 V DC	TR SL LD 24 V UC	TR SL LD 48 V UC	TR SL LD 60 V UC
Rated voltage AC/DC	12 V DC	24 V AC / 34 V DC	48 V AC / 68 V DC	60 V AC / 85 V DC
Max. continuous voltage U <sub>c</sub> (AC) / (DC)	15 V DC	30 V AC / 42 V DC	60 V AC / 85 V DC	75 V AC / 106 V DC
Signal transmission properties (-3 dB)	≤ 700 kHz	≤ 700 kHz	≤ 700 kHz	≤ 700 kHz
Pulse reset capacity	≤ 30 ms	≤ 30 ms	≤ 30 ms	≤ 30 ms
Residual voltage U <sub>r</sub>	≤ 40 V	≤ 100 V	≤ 220 V	≤ 330 V
wire-wire / wire-PE / GND-PE	- / 74 V / -	- / 110 V / -	- / 175 V / -	- / 230 V / -
Protection level on output side sym.	-	-	-	-
Input 1 kV/μs, typ.	-	-	-	-
Protection level on output side unsym., Input 1 kV/μs, typ.	74 V	110 V	175 V	230 V
Surge strength C3	10 A	50 A	50 A	50 A
Disconnect lever	Yes	Yes	Yes	Yes
Testing option	Functional screw with test plug receptacle connection 1, 2, 4, 5	Functional screw with test plug receptacle connection 1, 2, 4, 5	Functional screw with test plug receptacle connection 1, 2, 4, 5	Functional screw with test plug receptacle connection 1, 2, 4, 5
Status indicator	Yes	Yes	Yes	Yes

Ordering data

Type	VSSC6 TR SL LD12Vdc0.5A	VSSC6 TR SL LD 24VUC 0.5A	VSSC6 TR SL LD 48VUC 0.5A	VSSC6 TR SL LD 60VUC 0.5A
Order No.	<b>1064380000</b>	<b>1064390000</b>	<b>1064400000</b>	<b>1064410000</b>
Qty.	10 pieces	10 pieces	10 pieces	10 pieces

Note



**VARITECTOR SSC 6AN**

**VSSC 6AN SLFG and TR SLFG – protection for binary signals (SL) with floating ground (FG), with and without disconnect lever (TR) and indicator (LD)**

Two stage surge protection with screw connection for instrumentation, control and automation technology

- Surge protection in terminal block format
- Modular width of just 6.2 mm
- Space saving design: 2 binary signals
- Torx® slotted screw connection
- Can be used to comply with the IEC 62305 installation standard and the IEC 61643-1/-22 applications standards
- Integrated PE contact in base element, safely discharges up to 20 kA (8/20 μs) and 2.5 kA (10/350 μs) to PE
- Version with floating ground PE connection used to avoid differences in voltage potential

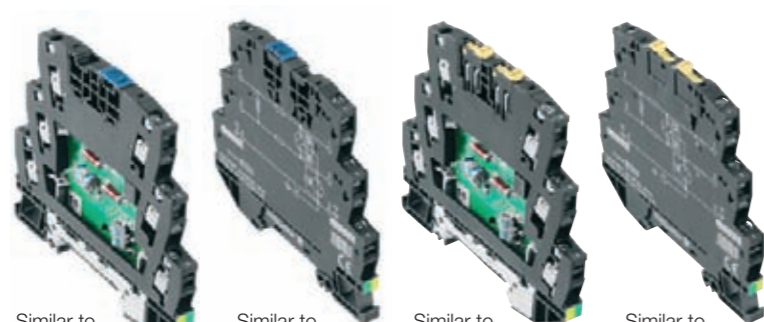

Similar to illustration    Similar to illustration    Similar to illustration    Similar to illustration

**Technical data**

General data	
Dielectric strength at FG against PE	≥ 500 V
Volume resistivity	1.8 Ω ± 10 %
Overstressed fault mode	Mode 2
Requirement category acc. to IEC 61643-21	C2; C3; D1
Standards	IEC 61643-21
Surge strength C2	2.5 kA
Surge strength C3	10 A; 50 A @ 60 V
Surge strength D1	1 kA
Rated discharge current $I_n$ (8/20 μs) wire-wire / wire-PE / GND-PE	- / 2.5 kA / 2.5 kA
Rated discharge current $I_{max}$ (8/20 μs) wire-wire / wire-PE / GND-PE	- / 10 kA / 10 kA
Lightning test current, $I_{imp}$ (10/350 μs) wire-wire / wire-PE / GND-PE	- / 10 kA / -
Storage temperature	-40 °C...+80 °C
Ambient temperature (operational)	-40 °C...+70 °C
Humidity	5...96 % RH
Degree of protection	IP20
Flammability class	V0
Connection data	
Connection	Torx® screw T15 / slot 0.8 x 4
Tightening torque	0.5 Nm
Conductor cross section, flexible, ferrule (DIN 46228-1), max.	4 mm <sup>2</sup>
Conductor cross section, flexible, ferrule (DIN 46228-1), min.	0.5 mm <sup>2</sup>
Conductor cross section, solid, max.	6 mm <sup>2</sup>
Conductor cross section, solid, min.	0.5 mm <sup>2</sup>
Conductor cross section, stranded, Rated connection, max.	4 mm <sup>2</sup>
Conductor cross section, stranded, Rated connection, min.	0.5 mm <sup>2</sup>
Stripping length	10 mm
Mounting rail	TS35
Dimensions	
Length x width x height	88.5 x 6.2 x 81 mm

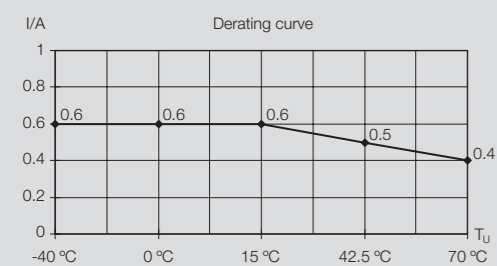
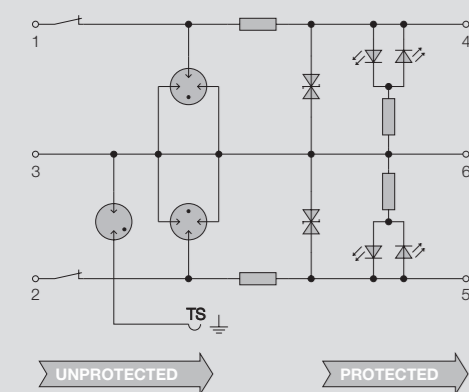
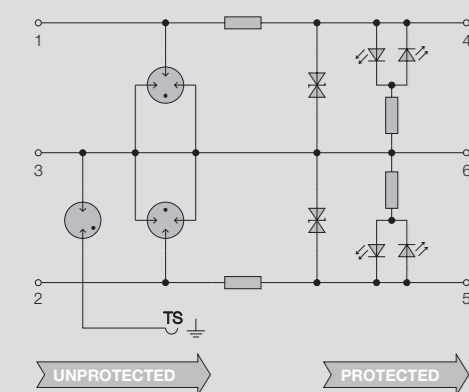

**Accessories:** Screwdriver: Torx® 9009170000, slotted 9008340000; test plug: PS 2.3 0180400000; EMC SET: 1067470000; marker: WS 10/6 181840000, DEK 6 0468560000, SNAPMARK 1805880000; end plate: 1063110000

VSSC 6AN SLFG and TR SLFG

Technical data

	SLFG LD 12 V DC	SLFG LD 24 V UC	SLFG LD 48 V UC	SLFG LD 60 V UC
Rated voltage AC/DC	12 V DC	24 V AC / 34 V DC	48 V AC / 68 V DC	60 V AC / 85 V DC
Max. continuous voltage $U_c$ (AC) / (DC)	15 V DC	30 V AC / 42 V DC	60 V AC / 85 V DC	75 V AC / 106 V DC
Signal transmission properties (-3 dB)	$\leq 700$ kHz	$\leq 700$ kHz	$\leq 700$ kHz	$\leq 700$ kHz
Pulse reset capacity	$\leq 20$ ms	$\leq 20$ ms	$\leq 20$ ms	$\leq 20$ ms
Residual voltage $U_p$	$\leq 1600$ V	$\leq 1650$ V	$\leq 1550$ V	$\leq 1550$ V
wire-wire / wire-PE / GND-PE	- / 74 V / 1400 V	- / 110 V / 1400 V	- / 175 V / 1200 V	- / 230 V / 1200 V
Protection level on output side sym.				
Input 1 kV/us, typ.	30 V	70 V	150 V	200 V
Protection level on output side unsym.,				
Input 1 kV/us, typ.	74 V	110 V	175 V	230 V
Nominal current	500 mA	200 mA (IEC 61643-21)	on request	on request
Status indicator	yes	yes	yes	yes

Ordering data

Type	VSSC6 SLFG 12VDC 0.5A	VSSC6 SLFG 24VUC 0.5A	VSSC6 SLFG 48VUC 0.5A	VSSC6 SLFG 60VUC 0.5A
Order No.	<b>1064420000</b>	<b>1064430000</b>	<b>1064440000</b>	<b>1064470000</b>
Qty.	10 pieces	10 pieces	10 pieces	10 pieces

Note



B



Technical data

	TR SLFG LD 12 V DC	TR SLFG LD 24 V UC	TR SLFG LD 48 V UC	TR SLFG LD 60 V UC
Rated voltage AC/DC	12 V DC	24 V AC / 34 V DC	48 V AC / 68 V DC	60 V AC / 85 V DC
Max. continuous voltage $U_c$ (AC) / (DC)	15 V DC	30 V AC / 42 V DC	60 V AC / 85 V DC	75 V AC / 106 V DC
Signal transmission properties (-3 dB)	$\leq 700$ kHz	$\leq 700$ kHz	$\leq 700$ kHz	$\leq 700$ kHz
Pulse reset capacity	$\leq 20$ ms	$\leq 20$ ms	$\leq 20$ ms	$\leq 20$ ms
Residual voltage $U_p$	$\leq 1600$ V	$\leq 1650$ V	$\leq 1550$ V	$\leq 1550$ V
wire-wire / wire-PE / GND-PE	- / 74 V / 1400 V	- / 110 V / 1400 V	- / 175 V / 1200 V	- / 230 V / 1200 V
Protection level on output side sym.				
Input 1 kV/us, typ.	30 V	70 V	150 V	200 V
Protection level on output side unsym.,				
Input 1 kV/us, typ.	74 V	110 V	175 V	230 V
Nominal current	500 mA	200 mA (IEC 61643-21)	on request	on request
Disconnect lever	Yes	Yes	Yes	Yes
Testing option	Functional screw with test plug receptacle connection 1, 2, 4, 5	Functional screw with test plug receptacle connection 1, 2, 4, 5	Functional screw with test plug receptacle connection 1, 2, 4, 5	Functional screw with test plug receptacle connection 1, 2, 4, 5
Status indicator	Yes	Yes	Yes	Yes

Ordering data

Type	VSSC6 TR SLFG LD 12VDC 0.5A	VSSC6 TR SLFG LD 24VUC 0.5A	VSSC6 TR SLFG LD 48VUC 0.5A	VSSC6 TR SLFG LD 60VUC 0.5A
Order No.	<b>1064490000</b>	<b>1064510000</b>	<b>1064510000</b>	<b>1064520000</b>
Qty.	10 pieces	10 pieces	10 pieces	10 pieces

Note





**VARITECTOR SSC 6AN**

**VSSC 6AN MOV and TR LD MOV 12 V DC and 24 V UC – with varistor, with and without disconnect lever (TR) and indicator (LD)**

Surge protection with screw connection for instrumentation, control and automation technology

- Surge protection in terminal block format
- Modular width of just 6.2 mm
- Space saving design: 2 analogue signals
- Torx® slotted screw connection
- Can be used to comply with the IEC 62305 installation standard and the IEC 61643-1/-22 applications standards
- Integrated PE contact in base element, safely discharges up to 20 kA (8/20 µs) and 2.5 kA (10/350 µs) to PE

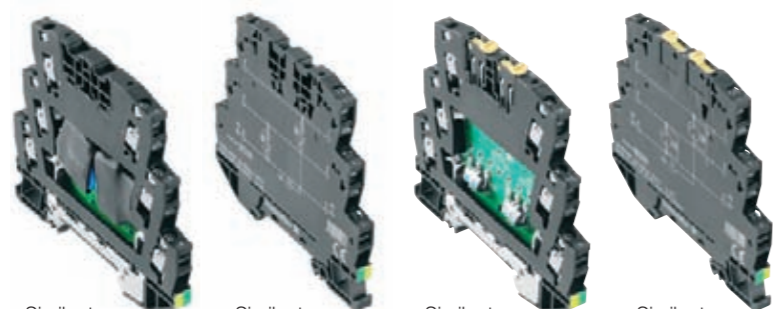

Similar to illustration    Similar to illustration    Similar to illustration    Similar to illustration

**Technical data**

General data	
Nominal current	12 A (see derating curve)
Volume resistivity	< 0.1 Ω
Overstressed fault mode	Mode 1
Requirement category acc. to IEC 61643-21	C1
Standards	IEC 61643-21 (Pending)
Surge strength C1	0.25 kA
Rated discharge current $I_n$ (8/20 µs) wire-wire / wire-PE / GND-PE	- / 500 A / -
Rated discharge current $I_{max}$ (8/20 µs) wire-wire / wire-PE / GND-PE	- / 1 kA / -
Storage temperature	-40 °C...+80 °C
Ambient temperature (operational)	-40 °C...+70 °C
Humidity	5...96 % RH
Degree of protection	IP20
Flammability class	V0
Connection data	
Connection	Torx® screw T15 / slot 0.8 x 4
Tightening torque	0.5 Nm
Conductor cross section, flexible, ferrule (DIN 46228-1), max.	4 mm²
Conductor cross section, flexible, ferrule (DIN 46228-1), min.	0.5 mm²
Conductor cross section, solid, max.	6 mm²
Conductor cross section, solid, min.	0.5 mm²
Conductor cross section, stranded, Rated connection, max.	4 mm²
Conductor cross section, stranded, Rated connection, min.	0.5 mm²
Stripping length	10 mm
Mounting rail	TSS5
Dimensions	
Length x width x height	88.5 x 6.2 x 81 mm

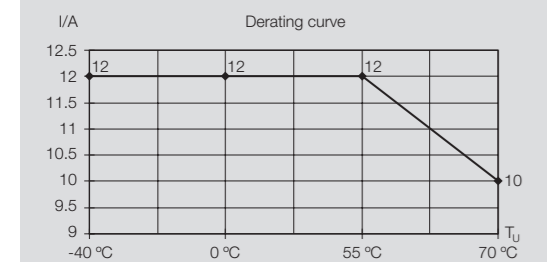
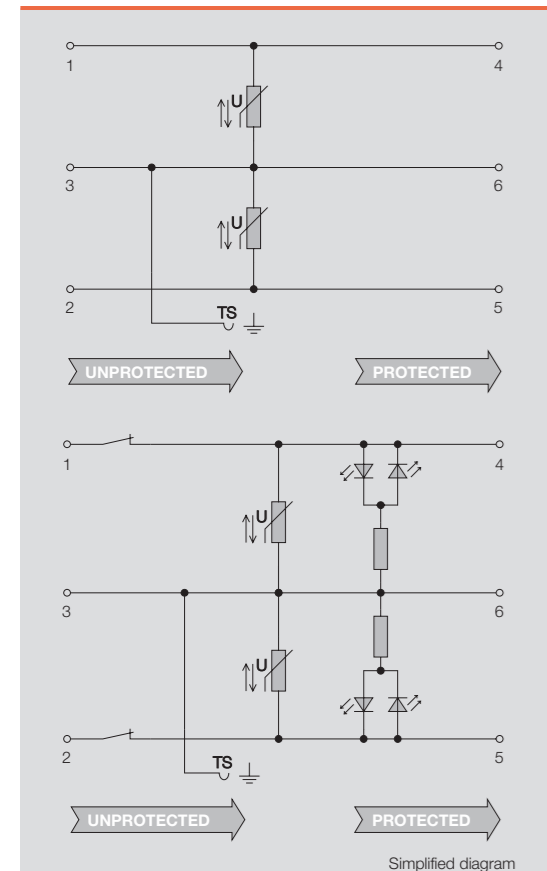

**Accessories:** Screwdriver: Torx® 9009170000, slotted 9008340000; test plug: PS 2.3 0180400000; EMC SET: 1067470000; marker: WS 10/6 1818400000, DEK 6 0468560000, SNAPMARK 1805880000; end plate: 1063110000



VSSC MOV and TR LD MOV  
12 V DC and 24 V UC

Technical data

	MOV 12 V DC	MOV 24 V UC
Rated voltage AC/DC	12 V DC	24 V AC / 34 V DC
Max. continuous voltage $U_c$ (AC) / (DC)	15 V DC	30 V AC / 42 V DC
Signal transmission properties (-3 dB)	$\leq 100$ kHz	$\leq 400$ kHz
Residual voltage $U_r$	$\leq 50$ V	$\leq 100$ V
wire-wire / wire-PE / GND-PE	- / 57 V / -	- / 120 V / -
Protection level on output side sym. Input 1 kV/ $\mu$ s, typ.	50 V	150 V

Ordering data

	MOV 12VDC	MOV 24VUC
Type	VSSC6 MOV 12VDC	VSSC6 MOV 24VUC
Order No.	<b>1064530000</b>	<b>1064540000</b>
Qty.	10 pieces	10 pieces

Note



Technical data

	TR LD MOV 12 V DC	TR LD MOV 24 V UC
Rated voltage AC/DC	12 V DC	24 V AC / 34 V DC
Max. continuous voltage $U_c$ (AC) / (DC)	15 V DC	30 V AC / 42 V DC
Signal transmission properties (-3 dB)	$\leq 100$ kHz	$\leq 400$ kHz
Residual voltage $U_r$	$\leq 50$ V	$\leq 100$ V
wire-wire / wire-PE / GND-PE	- / 57 V / -	- / 120 V / -
Protection level on output side sym. Input 1 kV/ $\mu$ s, typ.	50 V	150 V
Disconnect lever	Yes	Yes
Testing option	Functional screw with test plug receptacle connection 1, 2, 4, 5	Functional screw with test plug receptacle connection 1, 2, 4, 5
Status indicator	Yes	Yes

Ordering data

	TR LD MOV 12Vdc	TR LD MOV 24VUC
Type	VSSC6 TR LD MOV 12Vdc	VSSC6 TR MOV 24VUC
Order No.	<b>1064800000</b>	<b>1064810000</b>
Qty.	10 pieces	10 pieces

Note



B



**VARITECTOR SSC 6AN**

**VSSC 6AN MOV and TR LD MOV  
48 V UC and 60 V UC – with varistor,  
with and without disconnect lever (TR)  
and indicator (LD)**

Surge protection with screw connection for instrumentation, control and automation technology

- Surge protection in terminal block format
- Modular width of just 6.2 mm
- Space saving design: 2 analogue signals
- Torx® slotted screw connection
- Can be used to comply with the IEC 62305 installation standard and the IEC 61643-1/-22 applications standards
- Integrated PE contact in base element, safely discharges up to 20 kA (8/20 μs) and 2.5 kA (10/350 μs) to PE

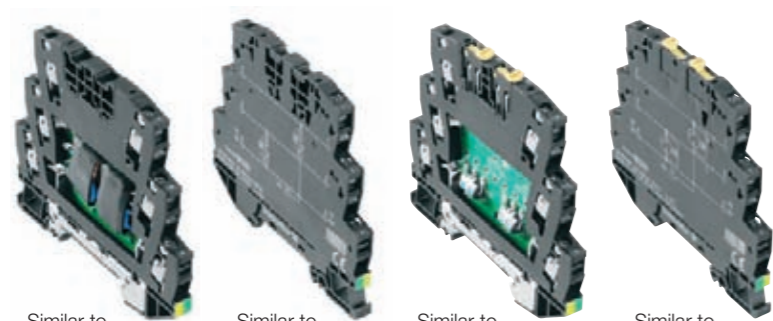

Similar to illustration

Similar to illustration

Similar to illustration

Similar to illustration

**Technical data**

General data	
Nominal current	12 A (see derating curve)
Volume resistivity	< 0.1 Ω
Overstressed fault mode	Mode 1
Requirement category acc. to IEC 61643-21	C1
Standards	acc. to IEC 61643-21
Surge strength C1	0.5 kA
Surge strength C2	1 kA
Rated discharge current $I_n$ (8/20 μs) wire-wire / wire-PE / GND-PE	- / 1 kA / -
Rated discharge current $I_{max}$ (8/20 μs) wire-wire / wire-PE / GND-PE	- / 4.5 kA / -
Storage temperature	-40 °C...+80 °C
Ambient temperature (operational)	-40 °C...+70 °C
Humidity	5...96 % RH
Degree of protection	IP20
Flammability class	V0
Connection data	
Connection	Torx® screw T15 / slot 0.8 x 4
Tightening torque	0.5 Nm
Conductor cross section, flexible, ferrule (DIN 46228-1), max.	4 mm²
Conductor cross section, flexible, ferrule (DIN 46228-1), min.	0.5 mm²
Conductor cross section, solid, max.	6 mm²
Conductor cross section, solid, min.	0.5 mm²
Conductor cross section, stranded, Rated connection, max.	4 mm²
Conductor cross section, stranded, Rated connection, min.	0.5 mm²
Stripping length	10 mm
Mounting rail	TS35
Dimensions	
Length x width x height	88.5 x 6.2 x 81 mm

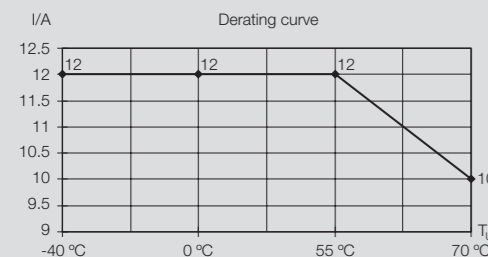
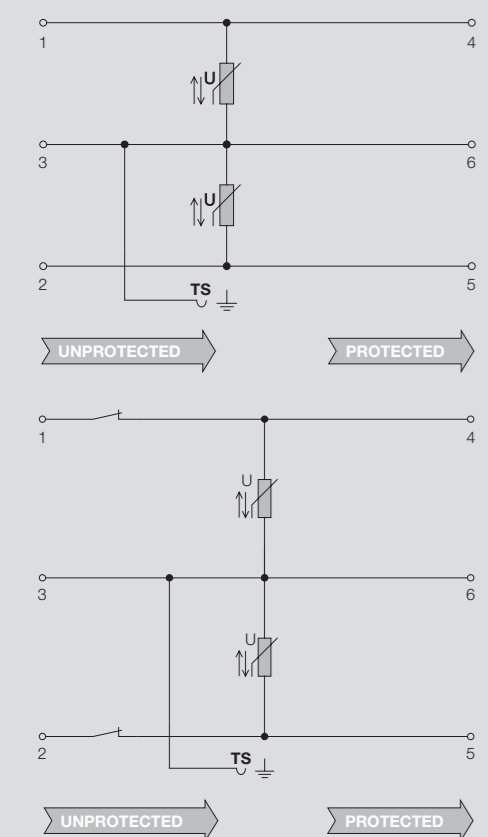

**Accessories:** Screwdriver: Torx® 9009170000, slotted 9008340000; test plug: PS 2.3 0180400000; EMC SET: 1067470000; marker: WS 10/6 1818400000, DEK 6 0468560000, SNAPMARK 1805880000; end plate: 1063110000

VSSC MOV and TR LD MOV  
48 V UC and 60 V UC

Technical data

	MOV 48VUC	MOV 60VUC
Rated voltage AC/DC	48 V AC / 60 V DC	60 V AC / 85 V DC
Max. continuous voltage $U_c$ (AC) / (DC)	60 V AC / 85 V DC	75 V AC / 106 V DC
Signal transmission properties (-3 dB)	$\leq 400$ kHz	$\leq 600$ kHz
Residual voltage $U_r$	$\leq 200$ V	$\leq 250$ V
wire-wire / wire-PE / GND-PE	- / 213 V / -	- / 269 V / -
Protection level on output side sym. Input 1 kV/ $\mu$ s, typ.	200 V	250 V

Ordering data

	MOV 48VUC	MOV 60VUC
Type	VSSC6 MOV 48VUC	VSSC6 MOV 60VUC
Order No.	<b>1064570000</b>	<b>1064600000</b>
Qty.	10 pieces	10 pieces

Note



Technical data

	TR LD MOV 48VUC	TR LD MOV 60VUC
Rated voltage AC/DC	48 V AC / 60 V DC	60 V AC / 85 V DC
Max. continuous voltage $U_c$ (AC) / (DC)	60 V AC / 85 V DC	75 V AC / 106 V DC
Signal transmission properties (-3 dB)	$\leq 400$ kHz	$\leq 600$ kHz
Residual voltage $U_r$	$\leq 200$ V	$\leq 250$ V
wire-wire / wire-PE / GND-PE	- / 213 V / -	- / 269 V / -
Protection level on output side sym. Input 1 kV/ $\mu$ s, typ.	200 V	250 V

Disconnect lever

Testing option

Status indicator

Ordering data

	TR LD MOV 48VUC	TR LD MOV 60VUC
Type	VSSC6 TR LD MOV 48VUC	VSSC6 TR LD MOV 60VUC
Order No.	<b>1064820000</b>	<b>1064830000</b>
Qty.	10 pieces	10 pieces

Note



B



**VARITECTOR SSC 6AN**

**VSSC 6AN MOV and TR LD MOV  
120 V UC, 150 V UC and 240 V UC – with  
varistor, with and without disconnect lever (TR)  
and indicator (LD)**

Surge protection with screw connection for instrumentation, control and automation technology

- Surge protection in terminal block format
- Modular width of just 6.2 mm
- Space saving design: 2 analogue signals
- Torx® slotted screw connection
- Can be used to comply with the IEC 62305 installation standard and the IEC 61643-1/-22 applications standards
- Integrated PE contact in base element, safely discharges up to 20 kA (8/20 μs) and 2.5 kA (10/350 μs) to PE

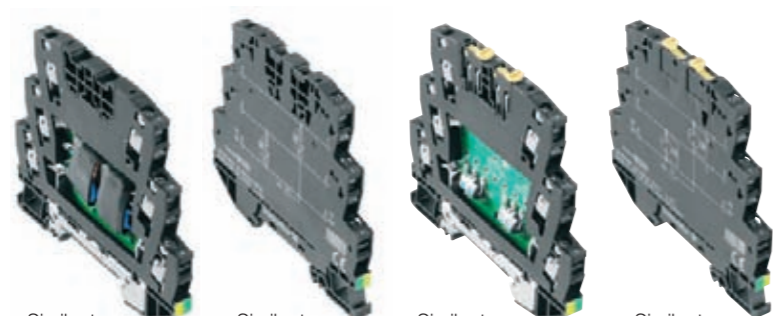

Similar to illustration

Similar to illustration

Similar to illustration

Similar to illustration

**Technical data**

General data	
Nominal current	12 A (see derating curve)
Volume resistivity	< 0.1 Ω
Overstressed fault mode	Mode 1
Requirement category acc. to IEC 61643-21	C1, C2
Standards	IEC 61643-21 (Pending)
Surge strength C1	0.5 kA
Surge strength C2	1.5 kA
Rated discharge current $I_n$ (8/20 μs) wire-wire / wire-PE / GND-PE	- / 500 A / -
Rated discharge current $I_{max}$ (8/20 μs) wire-wire / wire-PE / GND-PE	- / 1.5 kA / -
Storage temperature	-40 °C...+80 °C
Ambient temperature (operational)	-40 °C...+70 °C
Humidity	5...96 % RH
Degree of protection	IP20
Flammability class	V0
Connection data	
Connection	Torx® screw T15 / slot 0.8 x 4
Tightening torque	0.5 Nm
Conductor cross section, flexible, ferrule (DIN 46228-1), max.	4 mm <sup>2</sup>
Conductor cross section, flexible, ferrule (DIN 46228-1), min.	0.5 mm <sup>2</sup>
Conductor cross section, solid, max.	6 mm <sup>2</sup>
Conductor cross section, solid, min.	0.5 mm <sup>2</sup>
Conductor cross section, stranded, Rated connection, max.	4 mm <sup>2</sup>
Conductor cross section, stranded, Rated connection, min.	0.5 mm <sup>2</sup>
Stripping length	10 mm
Mounting rail	TS35
Dimensions	
Length x width x height	88.5 x 12.4 x 81 mm

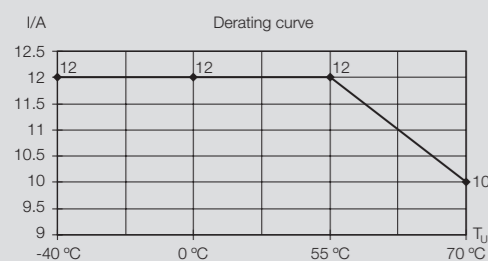
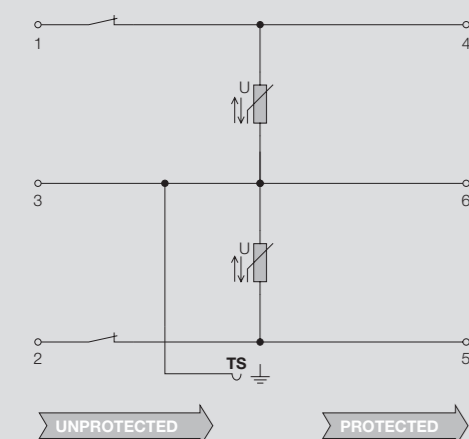
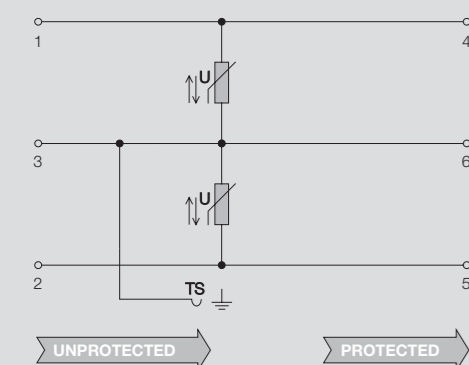

**Accessories:** Screwdriver: Torx® 9009170000, slotted 9008340000; test plug: PS 2.3 0180400000; EMC SET: 1067470000; marker: WS 10/6 1818400000, DEK 6 0468560000, SNAPMARK 1805880000; end plate: 1063110000

VSSC MOV and TR LD MOV  
120 V UC, 150 V UC and 240 V UC

Technical data

	MOV 120VUC	MOV 150VUC	MOV 240VUC
Rated voltage AC/DC	120 V AC / 170 V DC	150 V AC / 212 V DC	240 V AC / 339 V DC
Max. continuous voltage $U_c$ (AC) / (DC)	150 V AC / 212 V DC	188 V AC / 266 V DC	288 V AC / 407 V DC
Signal transmission properties (-3 dB)	$\leq 1$ MHz	$\leq 1$ MHz	$\leq 1,7$ MHz
Residual voltage $U_r$	$\leq 500$ V	$\leq 600$ V	$\leq 900$ V
wire-wire / wire-PE / GND-PE	- / 543 V / -	- / 641 V / -	- / 1022 V / -
Protection level on output side sym. Input 1 kV/ $\mu$ s, typ.	500 V	600 V	1000 V

Ordering data

Type	VSSC6 MOV 120VUC	VSSC6 MOV 150VUC	VSSC6 MOV 240VUC
Order No.	<b>1064610000</b>	<b>1064620000</b>	<b>1064630000</b>
Qty.	10 pieces	10 pieces	10 pieces

Note



B



Technical data

	TR LD MOV 120VUC	TR LD MOV 150VUC	TR LD MOV 240VUC
Rated voltage AC/DC	120 V AC / 170 V DC	150 V AC / 212 V DC	240 V AC / 339 V DC
Max. continuous voltage $U_c$ (AC) / (DC)	150 V AC / 212 V DC	188 V AC / 266 V DC	288 V AC / 407 V DC
Signal transmission properties (-3 dB)	$\leq 1$ MHz	$\leq 1$ MHz	$\leq 1,7$ MHz
Residual voltage $U_r$	$\leq 500$ V	$\leq 600$ V	$\leq 900$ V
wire-wire / wire-PE / GND-PE	- / 543 V / -	- / 641 V / -	- / 1022 V / -
Protection level on output side sym. Input 1 kV/ $\mu$ s, typ.	500 V	600 V	1000 V

Disconnect lever

Yes

Testing option

Functional screw with test plug receptacle connection 1, 2, 4, 5

Status indicator

Yes

Ordering data

Type	VSSC6 TR LD MOV 120VUC	VSSC6 TR LD MOV 150VUC	VSSC6 TR LD MOV 240VUC
Order No.	<b>1064840000</b>	<b>1064850000</b>	<b>1064860000</b>
Qty.	10 pieces	10 pieces	10 pieces

Note



**VARITECTOR SSC 6AN**

**VSSC 6AN GDT and TR GDT 10 kA – with gas discharge tube, with and without disconnect lever (TR)**

Surge protection with screw connection for instrumentation, control and automation technology

- Surge protection in terminal block format
- Modular width of just 6.2 mm or 12.4 mm
- Space saving design: 2 analogue signals
- Torx® slotted screw connection
- Can be used to comply with the IEC 62305 installation standard and the IEC 61643-1/-22 applications standards
- Integrated PE contact in base element, safely discharges up to 20 kA (8/20 μs) and 2.5 kA (10/350 μs) to PE

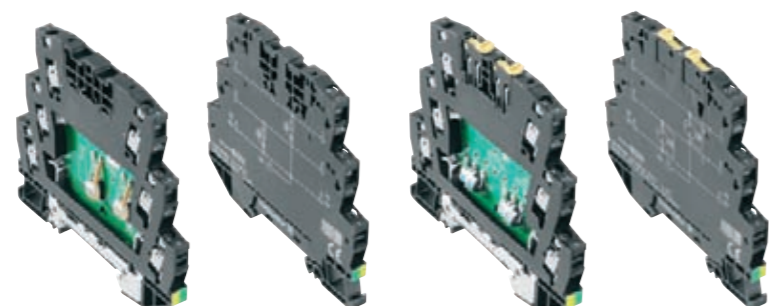

Similar to illustration

Similar to illustration

Similar to illustration

Similar to illustration

**Technical data**

General data	
Nominal current	12 A (see derating curve)
Volume resistivity	< 0.1 Ω
Overstressed fault mode	Mode 2
Requirement category acc. to IEC 61643-21	C2, C3, D1
Standards	IEC 61643-21
Surge strength C2	2.5 kA
Surge strength C3	50 A
Rated discharge current $I_n$ (8/20 μs) wire-wire / wire-PE / GND-PE	- / 2.5 kA / -
Rated discharge current $I_{max}$ (8/20 μs) wire-wire / wire-PE / GND-PE	- / 10 kA / -
Lightning test current, $I_{imp}$ (10/350 μs) wire-wire / wire-PE / GND-PE	- / 1 kA / -
Storage temperature	-40 °C...+80 °C
Ambient temperature (operational)	-40 °C...+70 °C
Humidity	5...96 % RH
Degree of protection	IP20
Flammability class	V0
Connection data	
Connection	Torx® screw T15 / slot 0.8 x 4
Tightening torque	0.5 Nm
Conductor cross section, flexible, ferrule (DIN 46228-1), max.	4 mm <sup>2</sup>
Conductor cross section, flexible, ferrule (DIN 46228-1), min.	0.5 mm <sup>2</sup>
Conductor cross section, solid, max.	6 mm <sup>2</sup>
Conductor cross section, solid, min.	0.5 mm <sup>2</sup>
Conductor cross section, stranded, Rated connection, max.	4 mm <sup>2</sup>
Conductor cross section, stranded, Rated connection, min.	0.5 mm <sup>2</sup>
Stripping length	10 mm
Mounting rail	TS35

**Derating curve**

T <sub>u</sub> [°C]	I [A]
-40	12
0	12
55	12
70	10

**Accessories:** Screwdriver: Torx® 9009170000, slotted 9008340000; test plug: PS 2.3 0180400000; EMC SET: 1067470000; marker: WS 10/6 1818400000, DEK 6 0468560000, SNAPMARK 1805880000; end plate: 1063110000

VSSC GDT and TR GDT 10 kA

Technical data

	GDT 24VUC 10kA	GDT 110VUC 10kA	GDT 240VUC 10kA
Rated voltage AC/DC	24 V AC / 34 V DC	110 V AC / 156 V DC	240 V AC / 339 V DC
Max. continuous voltage $U_c$ (AC) / (DC)	30 V AC / 42 V DC	138 V AC / 195 V DC	288 V AC / 407 V DC
Signal transmission properties (-3 dB)	$\leq 2$ MHz	$\leq 2$ MHz	$\leq 2$ MHz
Pulse reset capacity	$\leq 30$ ms	$\leq 30$ ms	$\leq 30$ ms
Residual voltage $U_p$	$\leq 1000$ V	$\leq 1000$ V	$\leq 800$ V
wire-wire / wire-PE / GND-PE	- / 976 V / -	- / 1153 V / -	- / 1792 V / -
Protection level on output side sym. Input 1 kV/ $\mu$ s, typ.	600 V	900 V	1200 V

Surge strength D1	1 kA	1 kA	0,5 kA
-------------------	------	------	--------

Dimensions

Length x width x height	88.5 x 6.2 x 81 mm	88.5 x 6.2 x 81 mm	88.5 x 12.4 x 81 mm
-------------------------	--------------------	--------------------	---------------------

Ordering data

Type	VSSC6 GDT 24VUC 10KA	VSSC6 GDT 110VUC 10KA	VSSC6 GDT 240VUC 10KA
Order No.	<b>1064640000</b>	<b>1064690000</b>	<b>1064710000</b>
Qty.	10 pieces	10 pieces	5 pieces

Note



Technical data

	TR GDT 24VUC 10kA	TR GDT 110VUC 10kA	TR GDT 240VUC 10kA
Rated voltage AC/DC	24 V AC / 34 V DC	110 V AC / 156 V DC	240 V AC / 339 V DC
Max. continuous voltage $U_c$ (AC) / (DC)	30 V AC / 42 V DC	138 V AC / 195 V DC	288 V AC / 407 V DC
Signal transmission properties (-3 dB)	$\leq 2$ MHz	$\leq 2$ MHz	$\leq 2$ MHz
Pulse reset capacity	$\leq 30$ ms	$\leq 30$ ms	$\leq 30$ ms
Residual voltage $U_p$	$\leq 1000$ V	$\leq 1000$ V	$\leq 800$ V
wire-wire / wire-PE / GND-PE	- / 976 V / -	- / 1153 V / -	- / 1792 V / -
Protection level on output side sym. Input 1 kV/ $\mu$ s, typ.	600 V	900 V	1200 V

Surge strength D1	1 kA	1 kA	0,5 kA
Disconnect lever	Yes	Yes	Yes

Testing option	Functional screw with test plug receptacle connection 1, 2, 4, 5	Functional screw with test plug receptacle connection 1, 2, 4, 5	Functional screw with test plug receptacle connection 1, 2, 4, 5
----------------	--	--	--

Dimensions

Length x width x height	88.5 x 6.2 x 81 mm	88.5 x 6.2 x 81 mm	88.5 x 12.4 x 81 mm
-------------------------	--------------------	--------------------	---------------------

Ordering data

Type	VSSC6 TR GDT 24VUC 10KA	VSSC6 TR GDT 110VUC 10KA	VSSC6 TR GDT 240VUC 10KA
Order No.	<b>1064870000</b>	<b>1064890000</b>	<b>1064920000</b>
Qty.	10 pieces	10 pieces	5 pieces

Note



B





## VARITECTOR SSC 6AN

### VSSC 6AN GDT and TR GDT 20 kA – with gas discharge tube

Surge protection with screw connection for instrumentation, control and automation technology

- Surge protection in terminal block format
- Modular width of just 12.4 mm
- Space saving design: 2 analogue signals
- Torx® slotted screw connection
- Can be used to comply with the IEC 62305 installation standard and the IEC 61643-1/-22 applications standards
- Integrated PE contact in base element, safely discharges up to 20 kA (8/20 μs) and 2.5 kA (10/350 μs) to PE

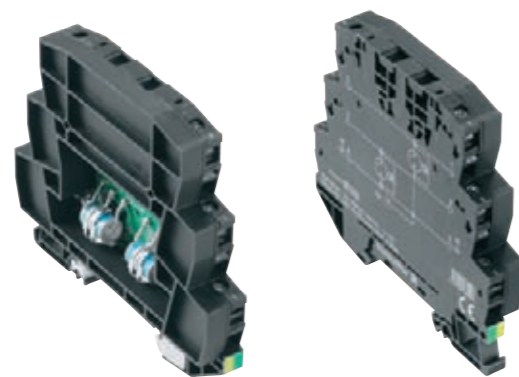

#### Technical data

General data	
Nominal current	12 A (see derating curve)
Volume resistivity	< 0.1 Ω
Overstressed fault mode	Mode 2
Requirement category acc. to IEC 61643-21	C2, C3, D1
Standards	IEC 61643-21
Surge strength C2	5 kA
Surge strength C3	100 A
Surge strength D1	2.5 kA
Rated discharge current $I_n$ (8/20 μs) wire-wire / wire-PE / GND-PE	- / 5 kA / -
Rated discharge current $I_{max}$ (8/20 μs) wire-wire / wire-PE / GND-PE	- / 20 kA / -
Lightning test current, $I_{imp}$ (10/350 μs) wire-wire / wire-PE / GND-PE	- / 2.5 kA / -
Storage temperature	-40 °C...+80 °C
Ambient temperature (operational)	-40 °C...+70 °C
Humidity	5...96 % RH
Degree of protection	IP20
Flammability class	V0
Connection data	
Connection	Torx® screw T15 / slot 0.8 x 4
Tightening torque	0.5 Nm
Conductor cross section, flexible, ferrule (DIN 46228-1), max.	4 mm <sup>2</sup>
Conductor cross section, flexible, ferrule (DIN 46228-1), min.	0.5 mm <sup>2</sup>
Conductor cross section, solid, max.	6 mm <sup>2</sup>
Conductor cross section, solid, min.	0.5 mm <sup>2</sup>
Conductor cross section, stranded, Rated connection, max.	4 mm <sup>2</sup>
Conductor cross section, stranded, Rated connection, min.	0.5 mm <sup>2</sup>
Stripping length	10 mm
Mounting rail	TS35
Dimensions	
Length x width x height	88.5 x 12.4 x 81 mm

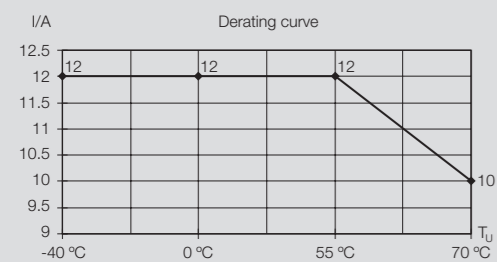
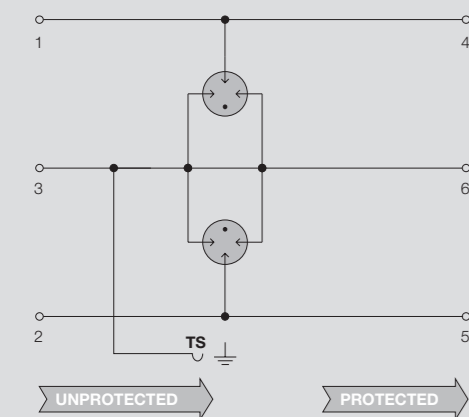

**Accessories:** Screwdriver: Torx® 9009170000, slotted 9008340000; test plug: PS 2.3 0180400000; EMC SET: 1067470000; marker: WS 10/6 1818400000, DEK 6 0468560000, SNAPMARK 1805880000; end plate: 1063110000

VSSC GDT 20 kA



Technical data

	GDT 24VUC 20kA	GDT 110VUC 20kA	GDT 240VUC 20kA
Rated voltage AC/DC	24 V AC / 34 V DC	110 V AC / 156 V DC	240 V AC / 339 V DC
Max. continuous voltage U <sub>c</sub> (AC) / (DC)	30 V AC / 42 V DC	138 V AC / 195 V DC	288 V AC / 407 V DC
Signal transmission properties (-3 dB)	≤ 2 MHz	≤ 2 MHz	≤ 2 MHz
Pulse reset capacity	≤ 30 ms	≤ 30 ms	≤ 30 ms
Residual voltage U <sub>r</sub>	≤ 1000 V	≤ 1000 V	≤ 800 V
wire-wire / wire-PE / GND-PE	- / 949 V / -	- / 992 V / -	- / 1288 V / -
Protection level on output side sym. Input 1 kV/μs, typ.	600 V	900 V	1200 V

Ordering data

Type	VSSC6 GDT 24VUC 20KA	VSSC6 GDT 110VUC 20KA	VSSC6 GDT 240VUC 20KA
Order No.	<b>1064670000</b>	<b>1064700000</b>	<b>1064720000</b>
Qty.	5 pieces	5 pieces	5 pieces

Note

B



**VARITECTOR SSC 6AN**

**VSSC 6AN TAZ and TR TAZ – with suppressor diode gap, with and without disconnect lever (TR) and indication (LD)**

Surge protection with screw connection for instrumentation, control and automation technology

- Surge protection in terminal block format
- Modular width of just 6.2 mm
- Space saving design: 2 analogue signals
- Torx® slotted screw connection
- Can be used to comply with the IEC 62305 installation standard and the IEC 61643-1/-22 applications standards
- Integrated PE contact in base element, safely discharges up to 20 kA (8/20 µs) and 2.5 kA (10/350 µs) to PE

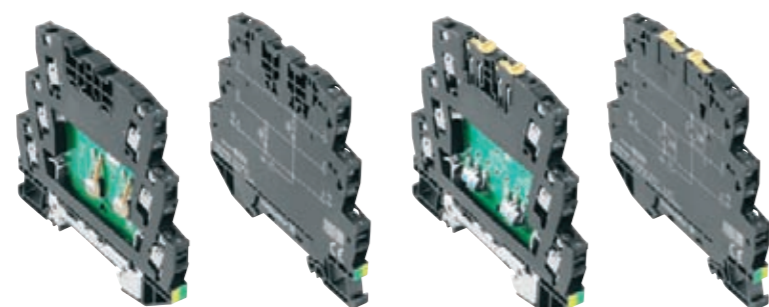

Similar to illustration

Similar to illustration

Similar to illustration

Similar to illustration

**Technical data**

General data	
Nominal current	12 A (see derating curve)
Volume resistivity	< 0.1 Ω
Overstressed fault mode	Mode 1
Storage temperature	-40 °C...+80 °C
Ambient temperature (operational)	-40 °C...+70 °C
Humidity	5...96 % RH
Degree of protection	IP20
Flammability class	V0
Connection data	
Connection	Torx® screw T15 / slot 0.8 x 4
Tightening torque	0.5 Nm
Conductor cross section, flexible, ferrule (DIN 46228-1), max.	4 mm²
Conductor cross section, flexible, ferrule (DIN 46228-1), min.	0.5 mm²
Conductor cross section, solid, max.	6 mm²
Conductor cross section, solid, min.	0.5 mm²
Conductor cross section, stranded, Rated connection, max.	4 mm²
Conductor cross section, stranded, Rated connection, min.	0.5 mm²
Stripping length	10 mm
Mounting rail	TSS5
Dimensions	
Length x width x height	88.5 x 6.2x 81 mm

**Derating curve**

Ambient Temperature (T <sub>u</sub> ) [°C]	Current (I) [A]
-40	12
0	12
55	12
70	10

**Accessories:** Screwdriver: Torx® 9009170000, slotted 9008340000; test plug: PS 2.3 0180400000; EMC SET: 1067470000; marker: WS 10/B 181840000, DEK 6 0468560000, SNAPMARK 1805880000; end plate: 1063110000

VSSC TAZ and TR LD TAZ

Technical data

	TAZ 12VDC	TAZ 24VUC	TAZ 48VUC	TAZ 60VUC
Rated voltage AC/DC	12 V DC	24 V UC / 34 V DC	48 V AC / 68 V DC	60 V AC / 85 V DC
Max. continuous voltage U <sub>c</sub> (AC) / (DC)	15 V DC	30 V AC / 42 V DC	60 V AC / 85 V DC	75 V AC / 106 V DC
Signal transmission properties (-3 dB)	≤ 1 MHz	≤ 1 MHz	≤ 1 MHz	≤ 1 MHz
Pulse reset capacity	≤ 30 ms	≤ 30 ms	≤ 30 ms	≤ 30 ms
Residual voltage U <sub>p</sub>	≤ 22 V	≤ 61 V	≤ 85 V	≤ 100 V
wire-wire / wire-PE / GND-PE	- / 26 V / -	- / 62 V / -	- / 200 V / -	- / 260 V / -
Protection level on output side sym.				
Input 1 kV/μs, typ.	30 V	70 V	150 V	200 V
Requirement category to IEC 61643-21	C3	C3	-	-
Surge strength C3	50 A	15 A	-	-
Rated discharge current I <sub>n</sub> (8/20 μs) wire-PE	200 A	100 A	50 A	50 A
Rated discharge current I <sub>max</sub> (8/20 μs) wire-PE	500 A	200 A	100 A	100 A
Standards	IEC 61643-21	IEC 61643-21	acc. to IEC 61643-21	acc. to IEC 61643-21

Ordering data

Type	VSSC6 TAZ 12VDC	VSSC6 TAZ 24VUC	VSSC6 TAZ 48VUC	VSSC6 TAZ 60VUC
Order No.	<b>1064730000</b>	<b>1064740000</b>	<b>1064770000</b>	<b>1064790000</b>
Qty.	10 pieces	10 pieces	10 pieces	10 pieces

Note



B



Technical data

	TR LD TAZ 12VDC	TR LD TAZ 24VUC	TR LD TAZ 48VUC	TR LD TAZ 60VUC
Rated voltage AC/DC	12 V DC	24 V UC / 34 V DC	48 V AC / 68 V DC	60 V AC / 85 V DC
Max. continuous voltage U <sub>c</sub> (AC) / (DC)	15 V DC	30 V AC / 42 V DC	60 V AC / 85 V DC	75 V AC / 106 V DC
Signal transmission properties (-3 dB)	≤ 1 MHz	≤ 1 MHz	≤ 1 MHz	≤ 1 MHz
Pulse reset capacity	≤ 30 ms	≤ 30 ms	≤ 30 ms	≤ 30 ms
Residual voltage U <sub>p</sub>	≤ 22 V	≤ 61 V	≤ 85 V	≤ 100 V
wire-wire / wire-PE / GND-PE	- / 26 V / -	- / 62 V / -	- / 200 V / -	- / 260 V / -
Protection level on output side sym.				
Input 1 kV/μs, typ.	30 V	70 V	150 V	200 V
Requirement category to IEC 61643-21	C3	C3	-	-
Surge strength C3	50 A	15 A	-	-
Rated discharge current I <sub>n</sub> (8/20 μs) wire-PE	200 A	100 A	50 A	50 A
Rated discharge current I <sub>max</sub> (8/20 μs) wire-PE	500 A	200 A	100 A	100 A
Standards	IEC 61643-21	IEC 61643-21	acc. to IEC 61643-21	acc. to IEC 61643-21
Disconnect lever	Yes	Yes	Yes	Yes
Testing option	Functional screw with test plug receptacle connection 1, 2, 4, 5	Functional screw with test plug receptacle connection 1, 2, 4, 5	Functional screw with test plug receptacle connection 1, 2, 4, 5	Functional screw with test plug receptacle connection 1, 2, 4, 5

Ordering data

Type	VSSC6 TR LD TAZ 12VDC	VSSC6 TR LD TAZ 24VUC	VSSC6 TR LD TAZ 48VUC	VSSC6 TR LD TAZ 60VUC
Order No.	<b>1064940000</b>	<b>1064950000</b>	<b>1064960000</b>	<b>1064970000</b>
Qty.	10 pieces	10 pieces	10 pieces	10 pieces

Note



## VARITECTOR SSC 6AN

### VSSC 6AN RS485, RS485 DP and RS232 – for interface signals

Two-stage surge protection with screw connection for instrumentation, control and automation technology

- Surge protection in terminal block format
- Modular width of just 6.2 mm
- Space saving design
- Torx® slotted screw connection
- Can be used to comply with the IEC 62305 installation standard and the IEC 61643-1/-22 applications standards
- Integrated PE contact in base element, safely discharges up to 20 kA (8/20 μs) and 2.5 kA (10/350 μs) to PE

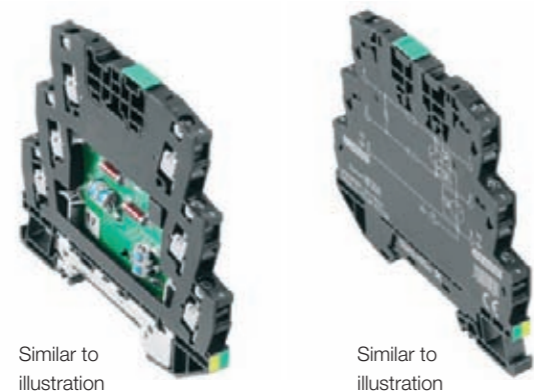

Similar to illustration

Similar to illustration

#### Technical data

General data	
Nominal current	500 mA (see derating curve)
Volume resistivity	1.8 Ω ± 10 %
Overstressed fault mode	Mode 2
Requirement category to IEC 61643-21	C2, C3, D1
Standards	IEC 61643-21
Surge strength C2	2.5 kA
Surge strength C3	10 A
Surge strength D1	0.5 kA
Rated discharge current $I_n$ (8/20 μs) wire-wire / wire-PE / GND-PE	2.5 kA / 2.5 kA / –
Rated discharge current $I_{max}$ (8/20 μs) wire-wire / wire-PE / GND-PE	10 kA / 10 kA / –
Lightning test current, $I_{imp}$ (10/350 μs) wire-wire / wire-PE / GND-PE	1 kA
Storage temperature	-40 °C...+80 °C
Ambient temperature (operational)	-40 °C...+70 °C
Humidity	5...96 % RH
Degree of protection	IP20
Flammability class	V0
Connection data	
Connection	Torx® screw T15 / slot 0.8 x 4
Tightening torque	0.5 Nm
Conductor cross section, flexible, ferrule (DIN 46228-1), max.	4 mm <sup>2</sup>
Conductor cross section, flexible, ferrule (DIN 46228-1), min.	0.5 mm <sup>2</sup>
Conductor cross section, solid, max.	6 mm <sup>2</sup>
Conductor cross section, solid, min.	0.5 mm <sup>2</sup>
Conductor cross section, stranded, Rated connection, max.	4 mm <sup>2</sup>
Conductor cross section, stranded, Rated connection, min.	0.5 mm <sup>2</sup>
Stripping length	10 mm
Mounting rail	TS35
Dimensions	
Length x width x height	88.5 x 6.2 x 81 mm

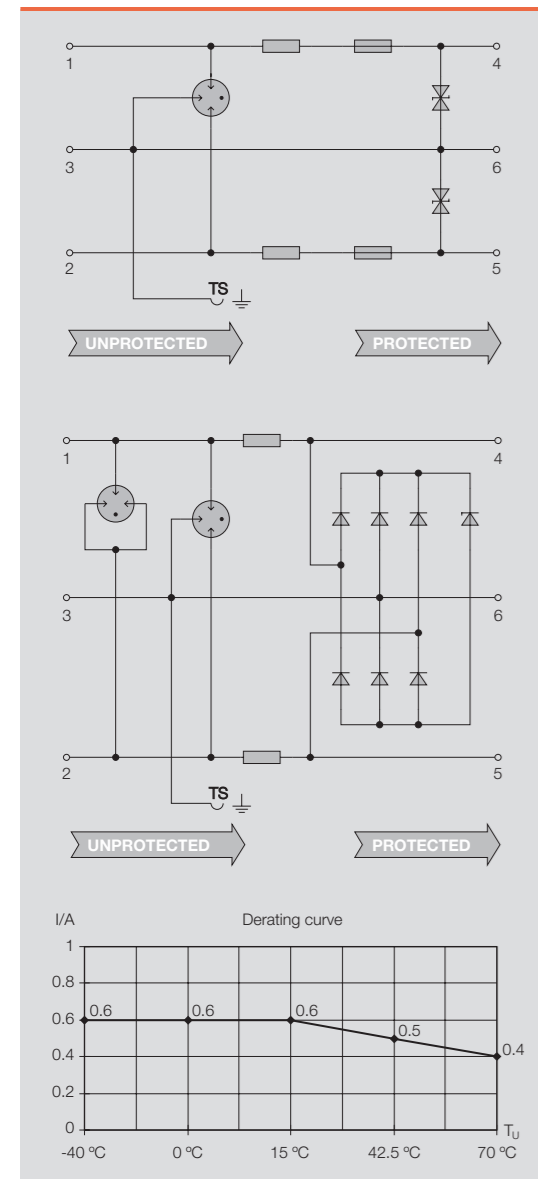

**Accessories:** Screwdriver: Torx® 9009170000, slotted 9008340000; test plug: PS 2.3 0180400000; EMC SET: 1067470000; marker: WS 10/6 1818400000, DEK 6 0468560000, SNAPMARK 1805880000; end plate: 1063110000

VSSC 6AN RS485, RS485 DP and RS232

B



Technical data	RS485	RS485 DP	RS232
Rated voltage AC/DC	12 V DC	12 V DC	12 V DC
Max. continuous voltage $U_c$ (DC)	15 V DC	15 V DC	15 V DC
Signal transmission properties (-3 dB)	$\leq 2$ MHz	$\leq 2$ MHz	$\leq 2$ MHz
Pulse reset capacity	$\leq 20$ ms	$\leq 20$ ms	$\leq 20$ ms
Residual voltage $U_r$	$\leq 94$ V	$\leq 94$ V	$\leq 80$ V
wire-wire / wire-PE / GND-PE	35 V / 35 V / -	35 V / 35 V / -	70 V / 35 V / -
Protection level on output side sym. Input 1 kV/ $\mu$ s, typ.	30 V	30 V	60 V
Protection level on output side unsym., Input 1 kV/ $\mu$ s, typ.	94 V	94 V	80 V
<b>Ordering data</b>			
Type	VSSC6 RS485	VSSC6 RS485 DP	VSSC6 RS232
Order No.	<b>1064980000</b>	<b>1065010000</b>	<b>1064990000</b>
Qty.	10 pieces	10 pieces	10 pieces
<b>Note</b>			

**VARITECTOR SSC 6AN**

**VSSC 6AN RTD – for temperature signals**

Two-stage surge protection with screw connection for instrumentation, control and automation technology

- Surge protection in terminal block format
- Modular width of just 6.2 mm
- Space saving design
- Torx® slotted screw connection
- Can be used to comply with the IEC 62305 installation standard and the IEC 61643-1/-22 applications standards
- Integrated PE contact in base element, safely discharges up to 20 kA (8/20 µs) and 2.5 kA (10/350 µs) to PE

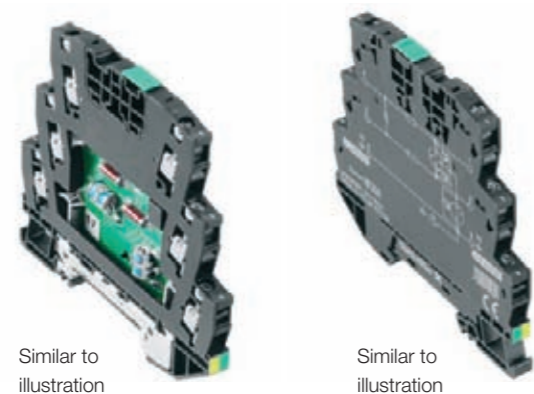

**Technical data**

General data	
Nominal current	300 mA
Dielectric strength at FG against PE	-
Volume resistivity	1.8 Ω ±10 %
Overstressed fault mode	Mode 2
Requirement category acc. to IEC 61643-21	C2, C3, D1
Standards	IEC 61643-21
Surge strength C2	2.5 kA 8/20 µs, 5 kV 1,2/50 µs
Surge strength C3	10 A 10/1000 µs
Surge strength D1	0.5 kA 10/350 µs
Rated discharge current I <sub>n</sub> (8/20 µs) wire-wire / wire-PE / GND-PE	2.5 kA / 2.5 kA / -
Rated discharge current I <sub>max</sub> (8/20 µs) wire-wire / wire-PE / GND-PE	10 kA / 10 kA / -
Lightning test current, I <sub>imp</sub> (10/350 µs) wire-wire / wire-PE / GND-PE	1 kA
Storage temperature	-40 °C...+80 °C
Ambient temperature (operational)	-40 °C...+70 °C
Humidity	5...96 % RH
Degree of protection	IP20
Flammability class	V0
Connection data	
Connection	Torx® screw T15 / slot 0.8 x 4
Tightening torque	0.5 Nm
Conductor cross section, flexible, ferrule (DIN 46228-1), max.	4 mm <sup>2</sup>
Conductor cross section, flexible, ferrule (DIN 46228-1), min.	0.5 mm <sup>2</sup>
Conductor cross section, solid, max.	6 mm <sup>2</sup>
Conductor cross section, solid, min.	0.5 mm <sup>2</sup>
Conductor cross section, stranded, Rated connection, max.	4 mm <sup>2</sup>
Conductor cross section, stranded, Rated connection, min.	0.5 mm <sup>2</sup>
Stripping length	10 mm
Mounting rail	TS35
Dimensions	
Length x width x height	88.5 x 6.2x 81 mm

**Accessories:** Screwdriver: Torx® 9009170000, slotted 9008340000; test plug: PS 2.3 0180400000; EMC SET: 1067470000; marker: WS 10/6 1818400000, DEK 6 0468560000, SNAPMARK 1805880000; end plate: 1063110000

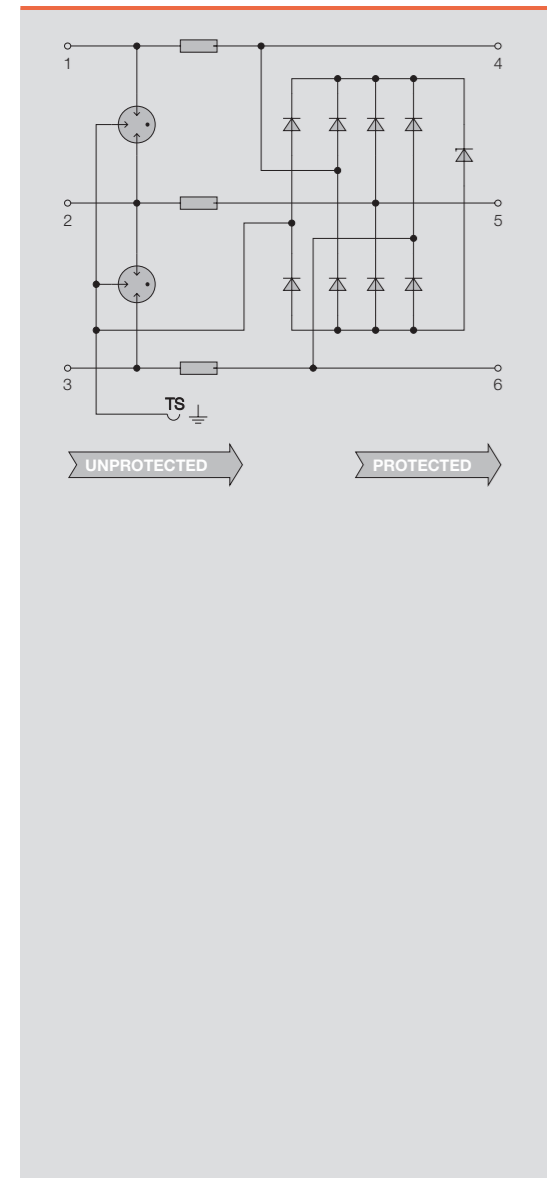



VSSC 6AN RTD

Technical data		RTD
Rated voltage AC/DC		1 V DC
Max. continuous voltage $U_c$ (DC)		5 V DC
Signal transmission properties (-3 dB)		$\leq 1$ MHz
Pulse reset capacity		$\leq 20$ ms
Residual voltage $U_r$		$\leq 126$ V
wire-wire / wire-PE / GND-PE		15 V / 15 V / -
Protection level on output side sym.		
Input 1 kV/ $\mu$ s, typ.		10 V
Protection level on output side unsym.,		
Input 1 kV/ $\mu$ s, typ.		10 V
Ordering data		
Type		VSSC6 RTD
Order No.		<b>1139710000</b>
Qty.		10 pieces
Note		

B



**VARITECTOR SSC 4AN****VARITECTOR SSC CL and CL FG**

Two-stage surge protection with screw connection for instrumentation, control and automation technology

- Surge protection in terminal-block format
- Modular width of just 6.2 mm
- Space-saving design: 1 analogue signal
- Torx slotted screw connection
- Version with non-earthed PE connection for avoiding potential differences
- Usable in accordance with installations standard IEC 62305
- Integrated PE contact in base element, safely discharges up to 20 kA (8/20  $\mu$ s) and 2.5 kA (10/350  $\mu$ s) to PE

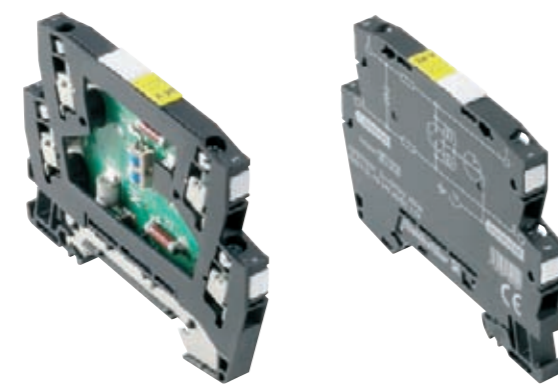

*Preliminary  
product data!*

**Technical data**

General data	
Nominal current $I_n$ at 25 °C	500 mA
Rated discharge current $I_{dc}$ (8 / 20 $\mu$ s) wire-wire / wire-PE / GND-PE	2.5 kA / 2.5 kA / -
Rated discharge current $I_{dc}$ (8 / 20 $\mu$ s) wire-wire / wire-PE / GND-PE	5 kA / 5 kA / -
Response time wire-wire / wire-PE / GND-PE	$\leq 1$ ns / $\leq 100$ ns / -
Volume resistivity per path	1.8 $\Omega \pm 10\%$
Discharge current $I_{sur}$	10 kA
Rated discharge current $I_{sur}$ (10 / 350 $\mu$ s)	1 kA
Surge strength	4 kV / 2 kA, 10 repetitions
Max. continuous voltage	1 A / 1 s, 5 repetitions
Overstressed fault mode	Mode 2
Requirement category acc. to IEC 61643-21	C1; C2; C3; D1
Rel. humidity	5% ... 96% RH
Degree of protection	IP20
Ambient temperature (operational)	-40 °C...+70 °C
Storage temperature	-40 °C...+80 °C
Approvals	UL, CSA pending
Clampable conductor	
Connection	Torx screw (T15) / slot (0.8 x 4.0)
Stripping length	7 mm
Tightening torque range	0.5 ... 0.8 Nm
Solid / stranded	0.5 ... 6 mm <sup>2</sup> / 0.5 ... 4 mm <sup>2</sup>
Flexible / flexible with ferrule	0.5 ... 2.5 mm <sup>2</sup>

**Dimensions**

Length x Width x Height	mm	76 x 6.2 x 58.5
-------------------------	----	-----------------

**Note:** end plate AP VSSC4: 1063120000

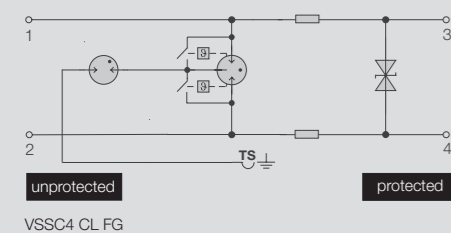
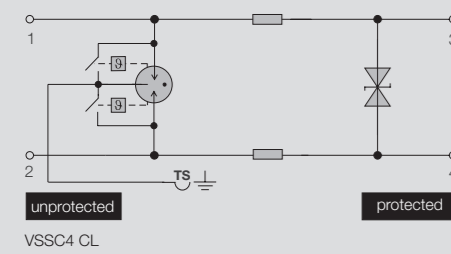
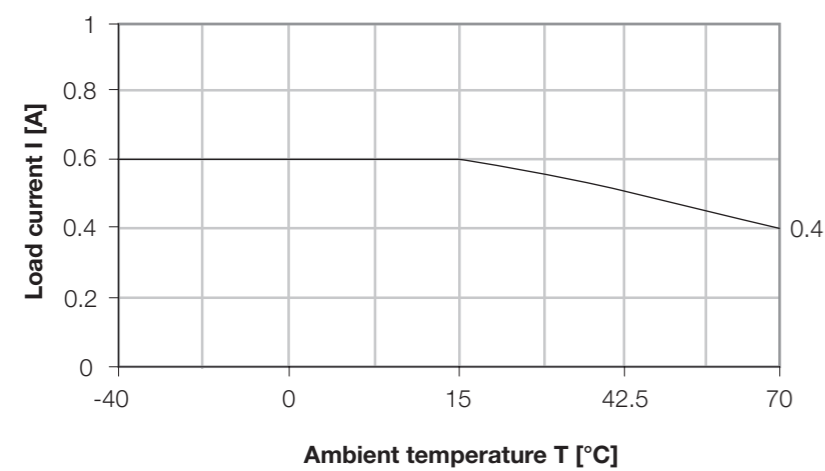
**Applications**

VARITECTOR SSC CL and CL FG

B



Ordering data	VSSC4 CL 12 V DC 0.5 A	VSSC4 CL FG 12 V DC 0.5 A	VSSC4 CL 24 V UC 0.5 A
Rated voltage $U_n$	12 V DC	12 V DC	24 V AC / 34 V DC
Max. continuous voltage $U_c$	15 V DC	15 V DC	30 V AC / 42 V DC
Voltage GND-PE	-	> 500 V	-
Capacitance	4 nF	4 nF	650 pF
Gas discharge tube	90 V	90 V	90 V
Supressordiode	16 V	16 V	43V
Limiting frequency (-3 dB) at load resistance	250 kHz	250 kHz	1.5 MHz
Protection level at			
$I_n$ wire-wire / wire-PE / GND-PE	35 V / 600 V / -	35 V / 1500 V / -	90 V / 600 V / -
1 kV / $\mu$ s wire-wire / wire-PE / GND-PE	30 V / 600 V / -	30 V / 1500 V / -	70 V / 600 V / -

Ordering data	VSSC4 CL 12VDC 0.5A	VSSC4 CL FG 12VDC 0.5A	VSSC4 CL 24VUC 0.5A
Type	VSSC4 CL 12VDC 0.5A	VSSC4 CL FG 12VDC 0.5A	VSSC4 CL 24VUC 0.5A
Order No.	<b>1063720000</b>	<b>1063760000</b>	<b>1063730000</b>
Qty.	10 piece	10 piece	10 piece

Note			
------	--	--	--

Ordering data	VSSC4 CL FG 24 V UC 0.5 A	VSSC4 CL 48 V UC 0.5 A	VSSC4 CL FG 48 V UC 0.5 A
Rated voltage $U_n$	24 V AC / 34 V DC	48 V AC / 68 V DC	48 V AC / 68 V DC
Max. continuous voltage $U_c$	30 V AC / 42 V DC	60 V AC / 85 V DC	60 V AC / 85 V DC
Voltage GND-PE	> 500 V	-	> 500 V
Capacitance	650 pF	450 pF	450 pF
Gas discharge tube	90 V	150 V	150 V
Supressordiode	43V	91 V	91 V
Limiting frequency (-3 dB) at load resistance	1.5 MHz	2.2 MHz	2.2 MHz
Protection level at			
$I_n$ wire-wire / wire-PE / GND-PE	90 V / 1500 V / -	200 V / 600 V / -	200 V / 1500 V / -
1 kV / $\mu$ s wire-wire / wire-PE / GND-PE	70 V / 1500 V / -	150 V / 600 V / -	150 V / 1500 V / -

Ordering data	VSSC4 CL FG 24VUC 0.5A	VSSC4 CL 48VUC 0.5A	VSSC4 CL FG 48VUC 0.5A
Type	VSSC4 CL FG 24VUC 0.5A	VSSC4 CL 48VUC 0.5A	VSSC4 CL FG 48VUC 0.5A
Order No.	<b>1063770000</b>	<b>1063740000</b>	<b>1063780000</b>
Qty.	10 piece	10 piece	10 piece

Note			
------	--	--	--

Ordering data	VSSC4 CL 60 V UC 0.5 A	VSSC4 CL FG 60 V UC 0.5 A
Rated voltage $U_n$	60 V AC / 85 V DC	60 V AC / 85 V DC
Max. continuous voltage $U_c$	75 V AC / 106 V DC	75 V AC / 106 V DC
Voltage GND-PE	-	> 500 V
Capacitance	350 pF	350 pF
Gas discharge tube	230 V	150 V
Supressordiode	120 V	120 V
Limiting frequency (-3 dB) at load resistance	2.8 MHz	2.8 MHz
Protection level at		
$I_n$ wire-wire / wire-PE / GND-PE	260 V / 600 V / -	260 V / 1500 V / -
1 kV / $\mu$ s wire-wire / wire-PE / GND-PE	200 V / 600 V / -	200 V / 1500 V / -

Ordering data	VSSC4 CL 60VUC 0.5A	VSSC4 CL FG 60VUC 0.5A
Type	VSSC4 CL 60VUC 0.5A	VSSC4 CL FG 60VUC 0.5A
Order No.	<b>1063750000</b>	<b>1063790000</b>
Qty.	10 piece	10 piece

Note		
------	--	--

**VARITECTOR SSC 4AN**

**VARITECTOR SSC SL and SL FG**

Two-stage surge protection with screw connection for instrumentation, control and automation technology

- Surge protection in terminal-block format
- Modular width of just 6.2 mm
- Space-saving design: 1 binary signal
- Torx slotted screw connection
- Version with non-earthed PE connection for avoiding potential differences
- Usable in accordance with installations standard IEC 62305
- Integrated PE contact in base element, safely discharges up to 20 kA (8/20 μs) and 2.5 kA (10/350 μs) to PE



*Preliminary  
product data!*

**Technical data**

General data	
Nominal current I <sub>n</sub> at 25 °C	500 mA
Rated discharge current I <sub>n</sub> (8 / 20 μs) wire-wire / wire-PE / GND-PE	- / 2.5 kA / -
Rated discharge current I <sub>max</sub> (8 / 20 μs) wire-wire / wire-PE / GND-PE	- / 10 kA / -
Response time wire-wire / wire-PE / GND-PE	- / ≤ 2 ns / ≤ 100 ns
Volume resistivity per path	1.8 Ω ± 10%
Discharge current I <sub>max</sub>	10 kA
Rated discharge current I <sub>max</sub> (10 / 350 μs)	1 kA
Surge strength	4 kV / 2 kA, 10 repetitions
Max. continuous voltage	1 A / 1 s, 5 repetitions
Overstressed fault mode	Mode 2
Requirement category acc. to IEC 61643-21	C1; C2; C3; D1
Rel. humidity	5% ... 96% RH
Degree of protection	IP20
Ambient temperature (operational)	-40 °C...+70 °C
Storage temperature	-40 °C...+80 °C
Approvals	UL, CSA pending
Clampable conductor	
Connection	Torx screw (T15) / slot (0.8 x 4.0)
Stripping length	7 mm
Tightening torque range	0.5 ... 0.8 Nm
Solid / stranded	0.5 ... 6 mm <sup>2</sup> / 0.5 ... 4 mm <sup>2</sup>
Flexible / flexible with ferrule	0.5 ... 2.5 mm <sup>2</sup>

Dimensions	
Length x Width x Height	mm 76 x 6.2 x 58.5
<b>Note:</b> end plate AP VSSC4: 1063120000	

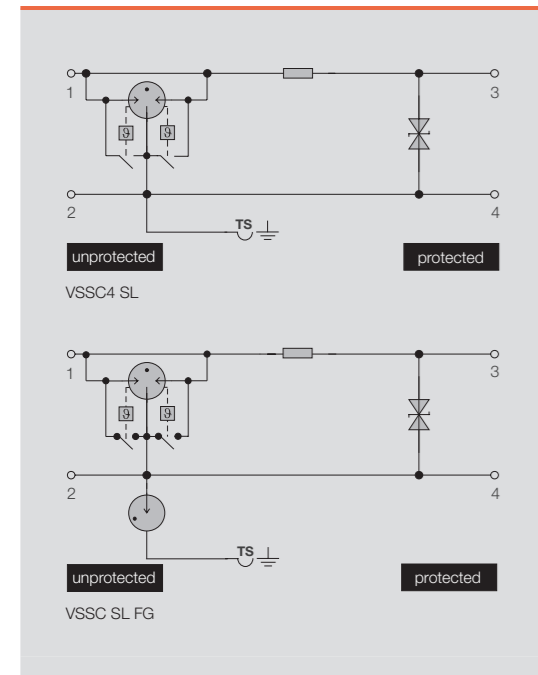

**Applications**

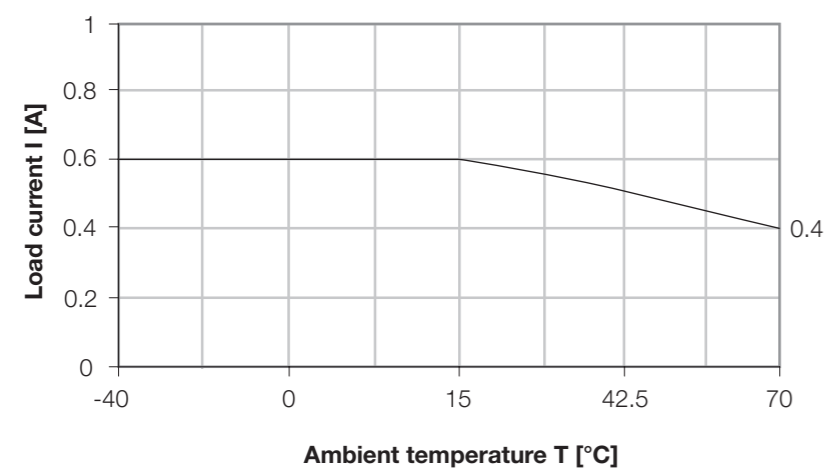

VARITECTOR SSC SL and SL FG

B



Ordering data	VSSC4 SL 12 V DC 0.5 A	VSSC4 SL FG 12 V DC 0.5 A	VSSC4 SL 24 V UC 0.5 A
Rated voltage $U_n$	12 V DC	12 V DC	24 V AC / 34 V DC
Max. continuous voltage $U_c$	15 V DC	15 V DC	30 V AC / 42 V DC
Voltage GND-PE	-	> 500 V	-
Capacitance	4 nF	4 nF	650 pF
Gas discharge tube	90 V	90 V	90 V
Supressordiode	16 V	16 V	43 V
Limiting frequency (-3 dB) at load resistance	250 KHz	250 KHz	1.5 MHz
Protection level at			
$I_n$ wire-wire / wire-PE / GND-PE	- / 35 V / -	- / 35 V / 1400 V	- / 90 V / -
1 kV / $\mu$ s wire-wire / wire-PE / GND-PE	- / 30 V / -	- / 30 V / 1400 V	- / 70 V / -

Ordering data	VSSC4 SL 12VDC 0.5A	VSSC4 SL FG 12VDC 0.5A	VSSC4 SL 24VUC 0.5A
Type	VSSC4 SL 12VDC 0.5A	VSSC4 SL FG 12VDC 0.5A	VSSC4 SL 24VUC 0.5A
Order No.	<b>1063830000</b>	<b>1063880000</b>	<b>1063840000</b>
Qty.	10 piece	10 piece	10 piece

Note			
------	--	--	--

Ordering data	VSSC4 SL FG 24 V UC 0.5 A	VSSC4 SL 48 V UC 0.5 A	VSSC4 SL FG 48 V UC 0.5 A
Rated voltage $U_n$	24 V AC / 34 V DC	48 V AC / 68 V DC	48 V AC / 68 V DC
Max. continuous voltage $U_c$	30 V AC / 42 V DC	60 V AC / 85 V DC	60 V AC / 85 V DC
Voltage GND-PE	> 500 V	-	> 500 V
Capacitance	650 pF	450 pF	450 pF
Gas discharge tube	90 V	150 V	150 V
Supressordiode	43 V	91 V	91 V
Limiting frequency (-3 dB) at load resistance	1.5 MHz	2.2 MHz	2.2 MHz
Protection level at			
$I_n$ wire-wire / wire-PE / GND-PE	- / 90 V / 1400 V	- / 200 V / -	- / 200 V / 1200 V
1 kV / $\mu$ s wire-wire / wire-PE / GND-PE	- / 70 V / 1400 V	- / 150 V / -	- / 150 V / 1200 V

Ordering data	VSSC4 SL FG 24VUC 0.5A	VSSC4 SL 48VUC 0.5A	VSSC4 SL FG 48VUC 0.5A
Type	VSSC4 SL FG 24VUC 0.5A	VSSC4 SL 48VUC 0.5A	VSSC4 SL FG 48VUC 0.5A
Order No.	<b>1063890000</b>	<b>1063860000</b>	<b>1063910000</b>
Qty.	10 piece	10 piece	10 piece

Note			
------	--	--	--

Ordering data	VSSC4 SL 60 V UC 0.5 A	VSSC4 SL FG 60 V UC 0.5 A
Rated voltage $U_n$	60 V AC / 85 V DC	60 V AC / 85 V DC
Max. continuous voltage $U_c$	75 V AC / 106 V DC	75 V AC / 106 V DC
Voltage GND-PE	-	> 500 V
Capacitance	350 pF	350 pF
Gas discharge tube	230 V	150 V
Supressordiode	120 V	120 V
Limiting frequency (-3 dB) at load resistance	2.8 MHz	2.8 MHz
Protection level at		
$I_n$ wire-wire / wire-PE / GND-PE	- / 260 V / -	- / 260 V / 1200 V
1 kV / $\mu$ s wire-wire / wire-PE / GND-PE	- / 200 V / -	- / 200 V / 1200 V

Ordering data	VSSC4 SL 60VUC 0.5A	VSSC4 SL FG 60VUC 0.5A
Type	VSSC4 SL 60VUC 0.5A	VSSC4 SL FG 60VUC 0.5A
Order No.	<b>1063870000</b>	<b>1063920000</b>
Qty.	10 piece	10 piece

Note		
------	--	--

**VARITECTOR SSC 4AN**

**VSSC4 MOV – components**

- Two-stage surge protection with screw connection for instrumentation, control and automation technology
- Modular width of just 6.2 mm or 12.4 mm
  - Components built-into terminal block, such as GDT, MOV, TAZ
  - Torx slotted screw connection
  - Integrated PE contact in base element, safely discharges up to 20 kA (8/20 μs) and 2.5 kA (10/350 μs) to PE
  - Accessories: end plate and extension frame



*Preliminary  
product data!*

**Technical data**

General data	
Nominal current I <sub>n</sub> at 25 °C	20 A
Response time wire-wire / wire-PE / GND-PE	- / 25 ns / -
Volume resistivity per path	< 0.1 Ω
Surge strength	1 kV / 100 A (10 / 1000 μs), 30 repetitions
Max. continuous voltage	0.25 A / 1 s, 5 repetitions
Combined pulse U <sub>oc</sub>	5 kV
Overstressed fault mode	Mode 1
Requirement category acc. to IEC 61643-21	C1; C2; C3
Rel. humidity	5%...96% RH
Degree of protection	IP20
Ambient temperature (operational)	-40 °C...+70 °C
Storage temperature	-40 °C...+80 °C
Approvals	UL, CSA pending
Clampable conductor	
Connection	Torx screw (T15) / slot (0.8 x 4.0)
Stripping length	7 mm
Tightening torque range	0.5 ... 0.8 Nm
Solid / stranded	0.5 ... 6 mm <sup>2</sup> / 0.5 ... 4 mm <sup>2</sup>
Flexible / flexible with ferrule	0.5 ... 2.5 mm <sup>2</sup>

**Note:** end plate AP VSSC4: 1063120000

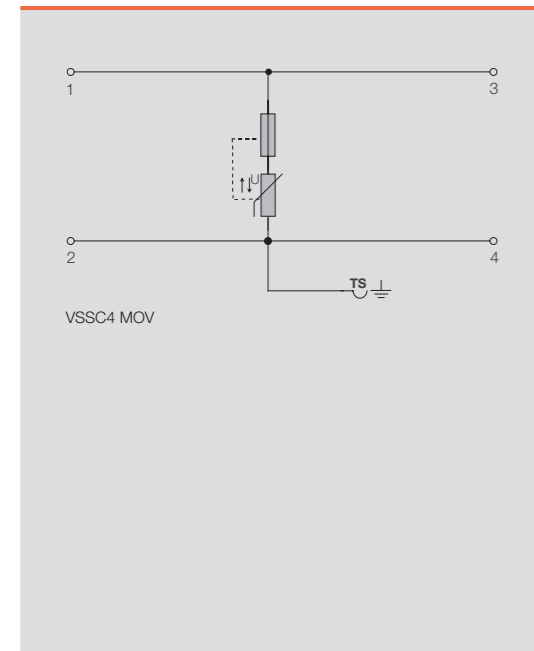

**Applications**

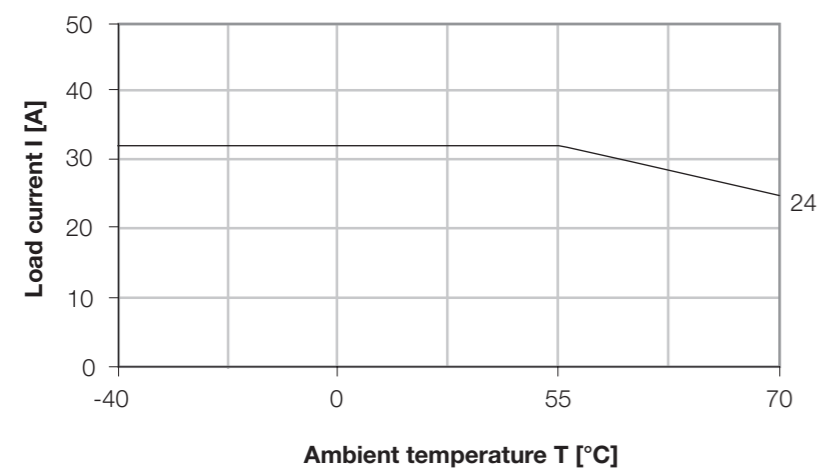

VSSC4 MOV – components

B



Ordering data	VSSC4 MOV 12 V DC	VSSC4 MOV 24 V UC	VSSC4 MOV 48 V UC	VSSC4 MOV 60 V UC
Rated voltage $U_n$	12 V DC	24 V AC / 34 V DC	48 V AC / 68 V DC	60 V AC / 85 V DC
Max. continuous voltage $U_c$	15 V DC	30 V AC / 42 V DC	60 V AC / 85 V DC	75 V AC / 106 V DC
Voltage GND-PE	-	-	-	-
Capacitance	12 nF	5 nF	1650 pF	1370 pF
Varistor	18 V	47 V	100 V	120 V
Limiting frequency (-3 dB) at load resistance	80 kHz	200 kHz	600 kHz	700 kHz
Rated discharge current $I_n$ (8/20 $\mu$ s)				
wire-wire / wire-PE / GND-PE	- / 500 A / -	- / 500 A / -	- / 2 kA / -	- / 2 kA / -
Rated discharge current $I_{max}$ (8/20 $\mu$ s)				
wire-wire / wire-PE / GND-PE	- / 1 kA / -	- / 1 kA / -	- / 4,5 kA / -	- / 4,5 kA / -
Discharge current $I_{max}$	1 kA	1 kA	4,5 kA	4,5 kA
Protection level at				
$U_n$ wire-wire / wire-PE / GND-PE	- / 65 V / -	- / 180 V / -	- / 270 V / -	- / 320 V / -
1 kV / $\mu$ s wire-wire / wire-PE / GND-PE	- / 50 V / -	- / 150 V / -	- / 200 V / -	- / 250 V / -

Dimensions				
Length x Width x Height	mm	76 x 6.2 x 58.5	76 x 6.2 x 58.5	76 x 6.2 x 58.5
Ordering data				
Type		VSSC4 MOV 12VDC	VSSC4 MOV 24VUC	VSSC4 MOV 48VUC
Order No.		<b>1063950000</b>	<b>1063960000</b>	<b>1063970000</b>
Qty.		10 piece	10 piece	10 piece
Note				

Ordering data	VSSC4 MOV 120 V UC	VSSC4 MOV 150 V UC	VSSC4 MOV 240 V UC
Rated voltage $U_n$	120 V AC / 170 V DC	150 V AC / 212 V DC	120 V AC / 170 V DC
Max. continuous voltage $U_c$	150 V AC / 212 V DC	188 V AC / 266 V DC	150 V AC / 212 V DC
Voltage GND-PE	-	-	-
Capacitance	2 nF	1,5 nF	2 nF
Varistor	240 V	300 V	240 V
Limiting frequency (-3 dB) at load resistance	500 kHz	650 kHz	500 kHz
Rated discharge current $I_n$ (8/20 $\mu$ s)			
wire-wire / wire-PE / GND-PE	- / 7,5 kA / -	- / 7,5 kA / -	- / 7,5 kA / -
Rated discharge current $I_{max}$ (8/20 $\mu$ s)			
wire-wire / wire-PE / GND-PE	- / 15 kA / -	- / 15 kA / -	- / 15 kA / -
Discharge current $I_{max}$	15 kA	15 kA	15 kA
Protection level at			
$U_n$ wire-wire / wire-PE / GND-PE	- / 720 V / -	- / 900 V / -	- / 720 V / -
1 kV / $\mu$ s wire-wire / wire-PE / GND-PE	- / 500 V / -	- / 600 V / -	- / 500 V / -

Dimensions			
Length x Width x Height	mm	76 x 12,4 x 58,5	76 x 12,4 x 58,5
Ordering data			
Type		VSSC4 MOV 120VUC	VSSC4 MOV 150VUC
Order No.		<b>1063990000</b>	<b>1064010000</b>
Qty.		10 piece	10 piece
Note			





VSSC4 GDT / TAZ – components

B



Ordering data	VSSC4 TAZ 12 V DC	VSSC4 TAZ 24 V UC	VSSC4 TAZ 48 V UC
Rated voltage $U_n$	12 V DC	24 V AC / 34 V DC	48 V AC / 75 V DC
Max. continuous voltage $U_c$	15 V DC	30 V AC / 42 V DC	60 V AC / 85 V DC
Alternating-current strength	0.1 A / 1 s, 5 repetitions	0.1 A / 1 s, 5 repetitions	0.1 A / 1 s, 5 repetitions
Surge strength	25 A (10 / 1000 $\mu$ s), 300 repetitions	10 A (10 / 1000 $\mu$ s), 300 repetitions	5 A (10 / 1000 $\mu$ s), 300 repetitions
Capacitance	4 nF	650 pF	450 pF
Requirement category acc. to IEC 61643-21	C1; C2; C3	C1; C2; C3	C1; C2; C3
Gas discharge tube			
Supressordiode	18 V	51 V	100 V
Limiting frequency (-3 dB) at load resistance	250 kHz	1.5 MHz	2.2 MHz
Rated discharge current $I_n$ (8/20 $\mu$ s)			
wire-wire / wire-PE	- / 200 A / -	- / 100 A / -	- / 50 A / -
Rated discharge current $I_{max}$ (8/20 $\mu$ s)			
wire-wire / wire-PE / GND-PE	- / 500 A / -	- / 200 A / -	- / 100 A / -
Discharge current $I_{max}$	500 A	200 A	100 A
Protection level at			
$I_n$ wire-wire / wire-PE / GND-PE	- / 35 V / -	- / 90 V / -	- / 200 V / -
1 kV / $\mu$ s wire-wire / wire-PE / GND-PE	- / 30 V / -	- / 70 V / -	- / 150 V / -
Response time wire-wire / wire-PE / GND-PE	- / 2 ns / -	- / 2 ns / -	- / 2 ns / -
Rated discharge current $I_{res}$ (10/350 $\mu$ s)			
<b>Dimensions</b>			
Length x Width x Height	mm 76 x 6.2 x 58.5	76 x 6.2 x 58.5	76 x 6.2 x 58.5
<b>Ordering data</b>			
Type	VSSC4 TAZ 12VDC	VSSC4 TAZ 24VUC	VSSC4 TAZ 48VUC
Order No.	<b>1064070000</b>	<b>1064080000</b>	<b>1064090000</b>
Qty.	10 piece	10 piece	10 piece
<b>Note</b>			

Ordering data	VSSC4 TAZ 60 V UC	VSSC4 GDT 110 V UC 20 KA	VSSC4 GDT 240 V UC 20 KA
Rated voltage $U_n$	60 V AC / 85 V DC	110 V AC / 156 V DC	240 V AC / 339 V DC
Max. continuous voltage $U_c$	75 V AC / 106 V DC	138 V AC / 195 V DC	288 V AC / 407 V DC
Alternating-current strength	0.1 A / 1 s, 5 repetitions	10 A / 1 s, 5 repetitions	10 A / 1 s, 5 repetitions
Surge strength	5 A (10 / 1000 $\mu$ s), 300 repetitions	20 kV / 10 kA (8 / 20 $\mu$ s), 10 repetitions	20 kV / 10 kA (8 / 20 $\mu$ s), 10 repetitions
Capacitance	350 pF	2 pF	2 pF
Requirement category acc. to IEC 61643-21	C1; C2; C3	in accordance with IEC61643-21	in accordance with IEC61643-21
Gas discharge tube		350 V	600 V
Supressordiode	130 V		
Limiting frequency (-3 dB) at load resistance	2.8 MHz	300 MHz	300 MHz
Rated discharge current $I_n$ (8/20 $\mu$ s)			
wire-wire / wire-PE / GND-PE	- / 50 A / -	- / 10 kA / -	- / 10 kA / -
Rated discharge current $I_{max}$ (8/20 $\mu$ s)			
wire-wire / wire-PE / GND-PE	- / 100 A / -	- / 20 kA / -	- / 20 kA / -
Discharge current $I_{max}$	100 A	20 kA	20 kA
Protection level at			
$I_n$ wire-wire / wire-PE / GND-PE	- / 260 V / -	- / 900 V / -	- / 1200 V / -
1 kV / $\mu$ s wire-wire / wire-PE / GND-PE	- / 200 V / -	- / 900 V / -	- / 1200 V / -
Response time wire-wire / wire-PE / GND-PE	- / 2 ns / -	- / 100ns / -	- / 100 ns / -
Rated discharge current $I_{res}$ (10/350 $\mu$ s)		2.5 kA	2.5 kA
<b>Dimensions</b>			
Length x Width x Height	mm 76 x 6.2 x 58.5	76 x 12.4 x 58.5	76 x 12.4 x 58.5
<b>Ordering data</b>			
Type	VSSC4 TAZ 60VUC	VSSC4 GDT 110VUC 20KA	VSSC4 GDT 240VUC 20KA
Order No.	<b>1064110000</b>	<b>1064050000</b>	<b>1064060000</b>
Qty.	10 piece	5 piece	5 piece
<b>Note</b>			

**VARITECTOR SSC 4AN**

**VSSC4 RC – components**

Two-stage surge protection with screw connection for instrumentation, control and automation technology

- Modular width of 12.4 mm
- Torx slotted screw connection
- Integrated PE contact in base element, safely discharges up to 20 kA (8/20 μs) and 2.5 kA (10/350 μs) to PE
- Accessories: end plate and extension frame



*Preliminary product data!*

**B**

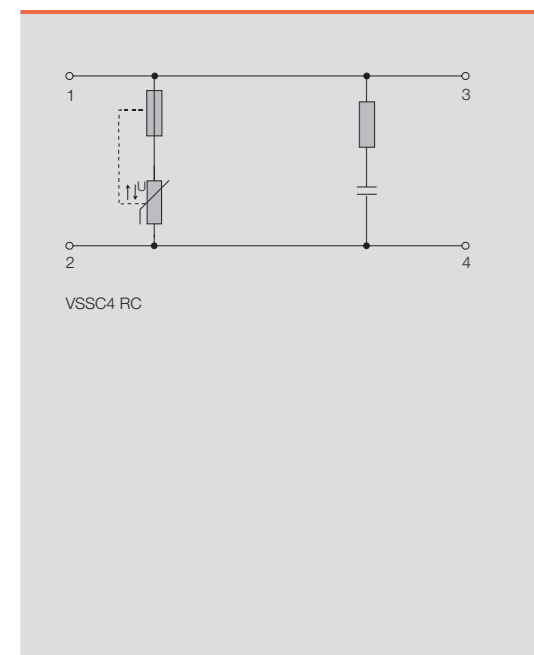

**Technical data**

General data	
Nominal current I <sub>n</sub> at 25 °C	20 A
Response time wire-wire / wire-PE / GND-PE	- / 25 ns / -
Volume resistivity per path	< 0.1 Ω
Surge strength	1 kV / 100A (10 / 1000 μs), 30 repetitions
Max. continuous voltage	0.25 A / 1 s, 5 repetitions
Overstressed fault mode	Mode 1
Requirement category acc. to IEC 61643-21	C1
Capacitance	220 nF
Limiting frequency (-3 dB) at load resistance	4 kHz
Rel. humidity	5%...96% RH
Degree of protection	IP20
Ambient temperature (operational)	-40 °C...+70 °C
Storage temperature	-40 °C...+80 °C
Approvals	UL, CSA
Clampable conductor	
Connection	Torx screw (T15) / slot (0.8 x 4.0)
Stripping length	7 mm
Tightening torque range	0.5 ... 0.8 Nm
Solid / stranded	0.5 ... 6 mm <sup>2</sup> / 0.5 ... 4 mm <sup>2</sup>
Flexible / flexible with ferrule	0.5 ... 2.5 mm <sup>2</sup>
Dimensions	
Length x Width x Height	mm 76 x 12.4 x 58.5
<b>Note:</b> end plate AP VSSC4: 1063120000	

**Applications**

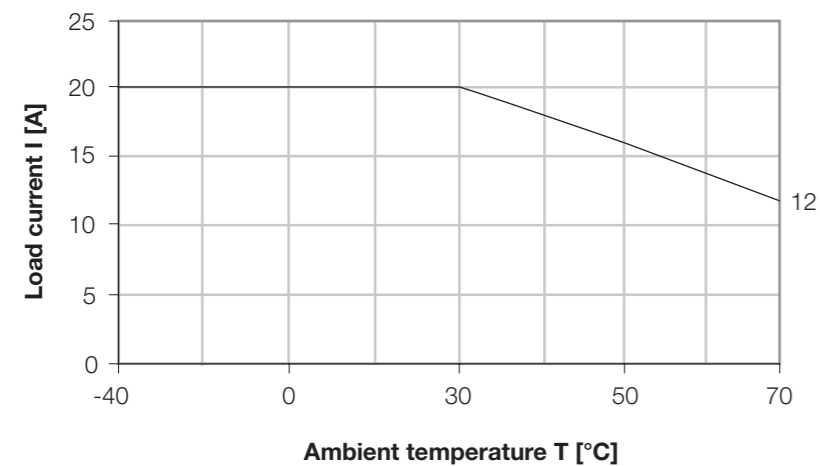

VSSC4 RC – components

Ordering data	VSSC4 RC 24 V UC	VSSC4 RC 240 V UC
Rated voltage $U_n$	24 V AC	240 V AC
Max. continuous voltage $U_c$	30 V AC / 42 V DC	275 V AC / 388 V DC
Voltage GND-PE	-	-
Alternating-current strength	0.25 A / 1 s, 30 repetitions	0.1 A / 1 s, 5 repetitions
Varistor	43 V	430 V
Surge strength C1	0.25 kA / 8/20 $\mu$ s 0.5 kV / 1.2/50 $\mu$ s	0.25 kA / 8/20 $\mu$ s 0.5 kV / 1.2/50 $\mu$ s
Protection level $U_p$	< 500 V	< 500 V
Rated discharge current $I_n$ (8/20 $\mu$ s) wire-wire / wire-PE / GND-PE	- / 500 A / -	- / 1 kA / -
Rated discharge current $I_{max}$ (8/20 $\mu$ s) wire-wire / wire-PE / GND-PE	- / 1 kA / -	- / 2.5 kA / -
Discharge current $I_{max}$ $I_n$ wire-wire / wire-PE / GND-PE	1 kA - / 150 V / -	2.5 kA - / 1500 V / -
Protection level at 1 kV / $\mu$ s wire-wire / wire-PE / GND-PE	- / 120 V / -	- / 500 V / -

Ordering data	VSSC4 RC 24VUC	VSSC4 RC 240VUC
Type	VSSC4 RC 24VUC	VSSC4 RC 240VUC
Order No.	<b>1064120000</b>	<b>1064130000</b>
Qty.	5 piece	5 piece
Note		

B



**PU II 750 V**

**Class II with varistors**

Surge protection of class II with Uc: 750 V

- plug-in varistor top section
- coded voltage level, var. voltgs.
- high energy absorption with short response time
- 180° rotatable insert
- no follow current
- installation in Insta distributor
- thermal safety function

**PU II 4/R 750 V / 30 kA**

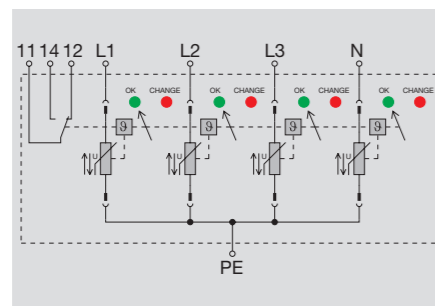

**PU II 3/R 750 V / 30 kA**

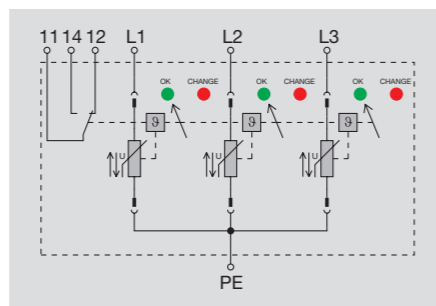

**Technical data**

Rated voltage	470 V / 690 V
Max. continuous voltage, Uc (AC)	750 V
Max. continuous voltage, Uc (DC)	750 V
Requirement category acc. to IEC 61643-1	Class II
Rated discharge current (8/20 µs)	15 kA
Limiting discharge current (8/20 µs)	30 kA
Discharge current, max. (8/20 µs)	100 kA
Response time	≤ 25 ns
Fuse, max.	125 A gL
Protection level at In (Up)	< 3000 V
Protection level at 5kA (Up)	< 2500 V
Temporary surge - U <sub>sur</sub>	800 V
Optical function indicator	green = OK; red = arrester faulty, replace
Signalling contact	250 V 1A 1CO bei PU II 4 R
Design	4 TE; Installation housing
Ambient temperature (operational)	-40 ... 70°C
Storage temperature	-40 ... 70°C
Approvals	CE, ÖVE
Standards	IEC61643-1, EN61643-11

Rated voltage	470 V / 690 V
Max. continuous voltage, Uc (AC)	750 V
Max. continuous voltage, Uc (DC)	750 V
Requirement category acc. to IEC 61643-1	Class II
Rated discharge current (8/20 µs)	15 kA
Limiting discharge current (8/20 µs)	30 kA
Discharge current, max. (8/20 µs)	100 kA
Response time	≤ 25 ns
Fuse, max.	125 A gL
Protection level at In (Up)	< 3000 V
Protection level at 5kA (Up)	< 2500 V
Temporary surge - U <sub>sur</sub>	800 V
Optical function indicator	green = OK; red = arrester faulty, replace
Signalling contact	250 V 1A 1CO bei PU II 4 R
Design	4 TE; Installation housing
Ambient temperature (operational)	-40 ... 70°C
Storage temperature	-40 ... 70°C
Approvals	CE, ÖVE
Standards	IEC61643-1, EN61643-11

Rated voltage	470 V / 690 V
Max. continuous voltage, Uc (AC)	750 V
Max. continuous voltage, Uc (DC)	750 V
Requirement category acc. to IEC 61643-1	Class II
Rated discharge current (8/20 µs)	15 kA
Limiting discharge current (8/20 µs)	30 kA
Discharge current, max. (8/20 µs)	80 kA
Response time	≤ 25 ns
Fuse, max.	125 A gL
Protection level at In (Up)	< 3000 V
Protection level at 5kA (Up)	< 2500 V
Temporary surge - U <sub>sur</sub>	800 V
Optical function indicator	green = OK; red = arrester faulty, replace
Signalling contact	250 V 1A 1CO bei PU II 3 R
Design	3 TE; Installation housing
Ambient temperature (operational)	-40 ... 70°C
Storage temperature	-40 ... 70°C
Approvals	CE, ÖVE
Standards	IEC61643-1, EN61643-11

**Dimensions**

Clamping range (rating- / min. / max.)	mm <sup>2</sup>	25 / 4 / 25	25 / 4 / 25
Length x Width x Height	mm	90 x 72 x 64	97 x 72 x 64

<b>Without telecomm. contact</b>	<b>With telecomm. contact</b>		
Clamping range (rating- / min. / max.)	mm <sup>2</sup>	25 / 4 / 25	25 / 4 / 25
Length x Width x Height	mm	90 x 72 x 64	97 x 72 x 64

<b>Without telecomm. contact</b>	<b>With telecomm. contact</b>		
Clamping range (rating- / min. / max.)	mm <sup>2</sup>	25 / 4 / 25	25 / 4 / 25
Length x Width x Height	mm	90 x 54 x 64	97 x 54 x 64

**Ordering data**

Version	Type	Qty.	Order No.
Without telecomm. contact	PU II 4 750V / 30kA	1	8975000000
With telecomm. contact	PU II 4 R 750V / 30kA	1	8975010000

Type	Qty.	Order No.
PU II 4 750V / 30kA	1	8975000000
PU II 4 R 750V / 30kA	1	8975010000

Type	Qty.	Order No.
PU II 3 750V / 30kA	1	8974960000
PU II 3 R 750V / 30kA	1	8974970000

**Accessories**

Plug-in spare arrester PU II 0 750V / 30kA - 1000460000
---

Plug-in spare arrester PU II 0 750V / 30kA - 1000460000
---

**Class II with varistors**

Surge protection of class II with Uc: 750 V

- plug-in varistor top section
- coded voltage level, var. voltgs.
- high energy absorption with short response time
- 180° rotatable insert
- no follow current
- installation in Insta distributor
- thermal safety function

**PU II 2/R 750 V / 30 kA**

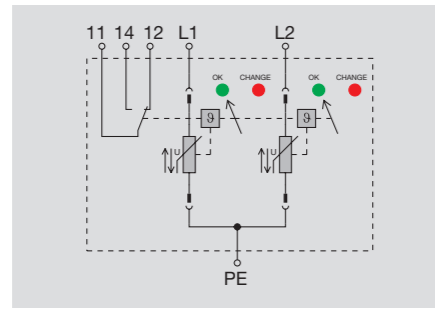

**PU II 1/R 750 V / 30 kA**

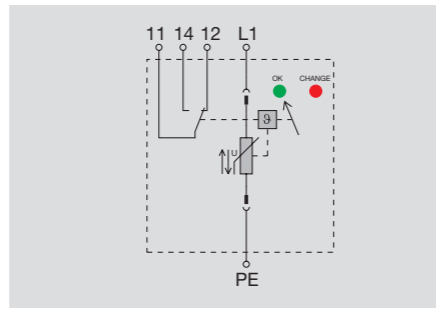

**Technical data**

Rated voltage	470 V / 690 V	470 V / 690 V
Max. continuous voltage, Uc (AC)	750 V	750 V
Max. continuous voltage, Uc (DC)	750 V	750 V
Requirement category acc. to IEC 61643-1	Class II	Class II
Rated discharge current (8/20 µs)	15 kA	15 kA
Limiting discharge current (8/20 µs)	30 kA	30 kA
Discharge current, max. (8/20 µs)	55 kA	30 kA
Response time	≤ 25 ns	≤ 25 ns
Fuse, max.	125 A gL	125 A gL
Protection level at In (Up)	< 3000 V	< 3000 V
Protection level at 5kA (Up)	< 2500 V	< 2500 V
Temporary surge - U <sub>sur</sub>	800 V	800 V
Optical function indicator	green = OK; red = arrester faulty, replace	green = OK; red = arrester faulty, replace
Signalling contact	250 V 1A 1CO bei PU II 2 R	250 V 1A 1CO bei PU II 1 R
Design	2 TE; Installation housing	1 TE; Installation housing
Ambient temperature (operational)	-40 ... 70°C	-40 ... 70°C
Storage temperature	-40 ... 70°C	-40 ... 70°C
Approvals	CE, ÖVE	CE, ÖVE
Standards	IEC61643-1, EN61643-11	IEC61643-1, EN61643-11

**Dimensions**

	Without telecomm. contact	With telecomm. contact	Without telecomm. contact	With telecomm. contact
Clamping range (rating- / min. / max.)	25 / 4 / 25	25 / 4 / 25	25 / 4 / 25	25 / 4 / 25
Length x Width x Height	90 x 36 x 64	97 x 36 x 64	90 x 18 x 64	97 x 18 x 64

**Note**

**Ordering data**

Version	Type	Qty.	Order No.	Type	Qty.	Order No.
Without telecomm. contact	PU II 2 750V / 30kA	1	8961900000	PU II 1 750V / 30kA	1	8974910000
With telecomm. contact	PU II 2 R 750V / 30kA	1	8974930000	PU II 1 R 750V / 30kA	1	8974920000

**Accessories**

Plug-in spare arrester PU II 0 750V / 30kA – 1000460000	Plug-in spare arrester PU II 0 750V / 30kA – 1000460000
---	---

**PU II 750 V**

**Class II with varistors**

Surge protection of class II with Uc: 750 V

- plug-in varistor top section
- coded voltage level, var. voltgs.
- high energy absorption with short response time
- 180° rotatable insert
- no follow current
- installation in Insta distributor
- thermal safety function

**PU II 2+1/R 750 V / 30 kA**

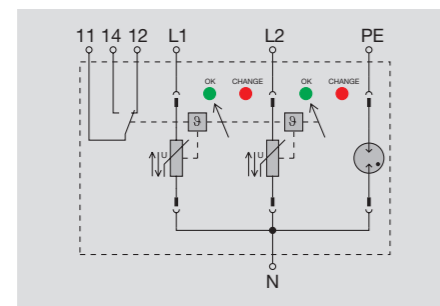

**PU II 3+1/R 750 V / 30 kA**

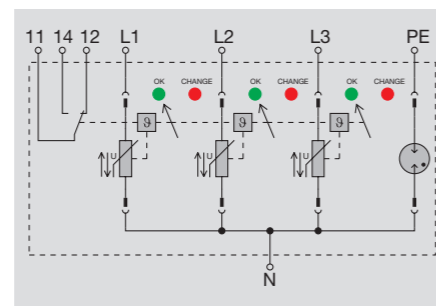

**Technical data**

Rated voltage	690 V
Max. continuous voltage, Uc (AC)	750 V
Max. continuous voltage, Uc (DC)	750 V
Requirement category acc. to IEC 61643-1	Class II
Rated discharge current (8/20 µs)	15 kA
Limiting discharge current (8/20 µs)	30 kA
Discharge current, max. (8/20 µs)	55 kA
Max. continuous voltage, Uc (N-PE)	260 V
Grenzableitstrom je Pfad 8/20 µs (N-PE)	40 kA
Protection level at I <sub>n</sub> (N-PE)	< 1350 V
Response time	≤ 25 ns
Fuse, max.	125 A gL
Protection level at I <sub>n</sub> (Up)	< 3000 V
Protection level at 5kA (Up)	< 2500 V
Temporary surge - U <sub>ov</sub>	800 V
Optical function indicator	green = OK; red = arrester faulty, replace
Signalling contact	250 V 1A 1CO bei PU II 2 R
Design	2 TE; Installation housing
Ambient temperature (operational)	-40 ... 70°C
Storage temperature	-40 ... 70°C
Approvals	CE, ÖVE
Standards	IEC61643-1, EN61643-11

Rated voltage	470 V / 690 V
Max. continuous voltage, Uc (AC)	750 V
Max. continuous voltage, Uc (DC)	750 V
Requirement category acc. to IEC 61643-1	Class II
Rated discharge current (8/20 µs)	15 kA
Limiting discharge current (8/20 µs)	30 kA
Discharge current, max. (8/20 µs)	150 kA
Max. continuous voltage, Uc (N-PE)	260 V
Grenzableitstrom je Pfad 8/20 µs (N-PE)	40 kA
Protection level at I <sub>n</sub> (N-PE)	< 1350 V
Response time	≤ 25 ns
Fuse, max.	125 A gL
Protection level at I <sub>n</sub> (Up)	< 3000 V
Protection level at 5kA (Up)	< 2500 V
Temporary surge - U <sub>ov</sub>	800 V
Optical function indicator	green = OK; red = arrester faulty, replace
Signalling contact	250 V 1A 1CO bei PU II 1 R
Design	1 TE; Installation housing
Ambient temperature (operational)	-40 ... 70°C
Storage temperature	-40 ... 70°C
Approvals	CE, ÖVE
Standards	IEC61643-1, EN61643-11

Rated voltage	470 V / 690 V
Max. continuous voltage, Uc (AC)	750 V
Max. continuous voltage, Uc (DC)	750 V
Requirement category acc. to IEC 61643-1	Class II
Rated discharge current (8/20 µs)	15 kA
Limiting discharge current (8/20 µs)	30 kA
Discharge current, max. (8/20 µs)	150 kA
Max. continuous voltage, Uc (N-PE)	260 V
Grenzableitstrom je Pfad 8/20 µs (N-PE)	40 kA
Protection level at I <sub>n</sub> (N-PE)	< 1350 V
Response time	≤ 25 ns
Fuse, max.	125 A gL
Protection level at I <sub>n</sub> (Up)	< 3000 V
Protection level at 5kA (Up)	< 2500 V
Temporary surge - U <sub>ov</sub>	800 V
Optical function indicator	green = OK; red = arrester faulty, replace
Signalling contact	250 V 1A 1CO bei PU II 1 R
Design	1 TE; Installation housing
Ambient temperature (operational)	-40 ... 70°C
Storage temperature	-40 ... 70°C
Approvals	CE, ÖVE
Standards	IEC61643-1, EN61643-11

**Dimensions**

Clamping range (rating- / min. / max.)	mm <sup>2</sup>	25 / 4 / 25
Length x Width x Height	mm	90 x 54 x 64

Without telecomm. contact	With telecomm. contact
25 / 4 / 25	25 / 4 / 25
90 x 54 x 64	97 x 54 x 64

Without telecomm. contact	With telecomm. contact
25 / 4 / 25	25 / 4 / 25
90 x 72 x 64	97 x 72 x 64

**Ordering data**

Version	Type	Qty.	Order No.
Without telecomm. contact	PU II 2+1 750V / 30kA	1	8974940000
With telecomm. contact	PU II 2+1 R 750V / 30kA	1	8974950000

Type	Qty.	Order No.
PU II 2+1 750V / 30kA	1	8974940000
PU II 2+1 R 750V / 30kA	1	8974950000

Type	Qty.	Order No.
PU II 3+1 750V / 30kA	1	8974980000
PU II 3+1 R 750V / 30kA	1	8974990000

**Accessories**

Plug-in spare arrester PU II 0 750V / 30kA – 1000460000
---

Plug-in spare arrester PU II 0 750V / 30kA – 1000460000
---





**Class I + II lightning arrester**

Combi-arrester

- Class I + II plug-in arrester for lightning protection equipotential bonding
- Suitable for lightning protection classes III and IV
- High discharge current with 12.5 kA (10/350 µs)
- Low residual voltage from <1.3 kV, thus also can be used for Class II surge protection
- High-power varistor, non-blow-out arrester
- No decoupling to class II and III arresters necessary
- Follow current need not be taken into account

**PU I 3+1/R 280V/12.5kA**

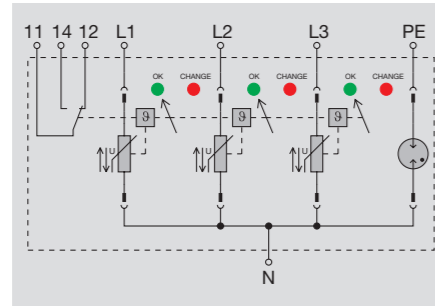

**Technical data**

Rated voltage (AC)	230 V
Max. continuous voltage, U <sub>c</sub> (AC)	280 V
Requirement category acc. to IEC 61643-1	I+II (combination arrester)
Rated discharge current I <sub>imp</sub> (10/350 µs)	12.5 kA
Charge, typical	6 As
Specific energy, per path	45 kJ/Ω
Short-circuit current extinction without back-up fuse	6 As
Short-circuit strength with max. back-up fuse	25 kA <sub>sc</sub>
Response time	L-N: ≤ 25 ns; N-PE: 100 µs
Fuse, max.	160 A gL/gG
Protection level Up (typical)	< 1300 V
Optical function indicator	green = OK; red = arrester faulty, replace
Signalling contact	250 V 1 A 1CO bei PU I R
Tightening torque range	2.5 Nm...3 Nm
Discharge current, max. (8/20 µs)	50 kA
Rated discharge current per path (8/20 µs)	30 kA
Temporary surge - U <sub>low</sub>	335 V
Design	4 TE; Installation housing
Ambient temperature (operational)	-40 ... 70°C
Storage temperature	-40 ... 70°C
Approvals	CE

**Dimensions**

Clamping range (rating- / min. / max.)	mm <sup>2</sup>	25 / 4 / 25
Length x Width x Height	mm	90 x 36 x 64

**Note**

**Ordering data**

Version	Type	Qty.	Order No.
	PU I 3+1 280V/12.5kA	1	8859080000
	PU I 3+1 R 280V/12.5kA	1	8859090000

Additional rated voltages on request

**Accessories**

Plug-in spare arrester PU I 0 280 V/12.5kA - 8859120000



## PU 1 TSG+

### Class I lightning arrester

- This space-saving, encapsulated lightning arrester can switch mains follow currents and discharge currents of max. 50 kA (10/350 µs). It enables installations in protective classes I and II.
- High degree of protection against short circuits, with max. back-up fuse of 50 kA. This ensures safe installations anywhere around the globe.
- The pluggable arrester always guarantees proper readability. It also ensures that the shortest path is taken to the system's earth potential.
- The arrester's status display enables defective modules to be quickly located and replaced. The status can also be forwarded on to the control room by means of the remote alarm signals.
- The low protection level (1.5 kV) increases the dielectric strength in the main distributor; as a result, the connected devices are not damaged.

### PU I 3+1 TSG+ 350 V 1,5 kV

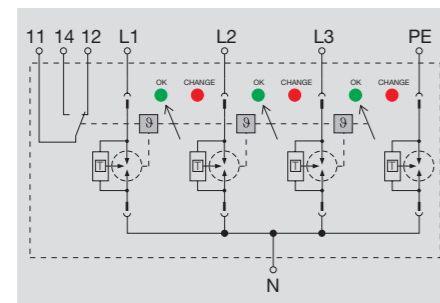

### PU I 3 TSG+ 350 V 1,5 kV

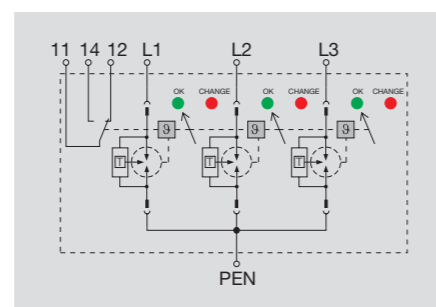

### Technical data

Control side	
Rated voltage (AC)	240 V
Max. continuous voltage, U <sub>c</sub> (AC)	350 V
Temporary surge - U <sub>sov</sub>	415 V
Requirement category acc. to IEC 61643-1	Class I
Rated discharge current I <sub>imp</sub> (10/350 µs) [L-PE]	25 kA
Rated discharge current I <sub>imp</sub> (10/350 µs) [N-PE]	100 kA
Specific energy, per path	160 kJ/Ohm
Short-circuit strength with max. back-up fuse	50 kA
PE current I <sub>le</sub> at U <sub>c</sub>	< 0,01 mA
Response time	≤ 100 ns
Fuse, max.	315A gI
Protection level Up (typical)	1,5 kV
Optical function indicator:	green = OK; red = arrester faulty, replace
Signalling contact	1 CO 250 V AC, 1 A / 125 V DC, 30 mA
Connection torque range	4...4,5 Nm
Design	Insta
Ambient temperature (operational)	-40 °C...+80 °C
Storage temperature	-40 °C...+80 °C
Standards	IEC61643-1, EN61643-11

240 V
350 V
415 V
Class I
25 kA
100 kA
160 kJ/Ohm
50 kA
< 0,01 mA
≤ 100 ns
315A gI
1,5 kV
green = OK; red = arrester faulty, replace
1 CO 250 V AC, 1 A / 125 V DC, 30 mA
4...4,5 Nm
Insta
-40 °C...+80 °C
-40 °C...+80 °C
IEC61643-1, EN61643-11

240 V / 415 V
350 V
415 V
Class I
25 kA
160 kJ / Ohm
50 kA
< 0,01 mA
≤ 100 ns
315 A gI
1,5 kV
green = OK; red = arrester faulty, replace
1 CO 250 V AC, 1 A / 125 V DC, 30 mA
4...4,5 Nm
Insta
-40 °C...+80 °C
-40 °C...+80 °C
IEC61643-1, EN61643-11

### Dimensions

Clamping range (rating- / min. / max.)	mm <sup>2</sup>	25 / 2,5 / 35
Length x Width x Height	mm	97 x 144 x 72,5

25 / 2,5 / 35
97 x 144 x 72,5

25 / 2,5 / 35
97 x 108 x 72,5

### Ordering data

Type	Qty.	Order No.
PU I 3+1 TSG+ 350V 1.5kV	1	8960510000

Type	Qty.	Order No.
PU I 3+1 TSG+ 350V 1.5kV	1	8960510000

Type	Qty.	Order No.
PU I 3 TSG+ 350V 1.5kV	1	8960490000

### Accessories

Plug-in spare arrester: PU I 0 TSG+ 350V 1,5kV – 8960520000
Plug-in spare arrester: PU I 0 N/PE TSG+ 350V – 1066040000

Plug-in spare arrester: PU I 0 TSG+ 350V 1,5kV – 8960520000
Plug-in spare arrester: PU I 0 N/PE TSG+ 350V – 1066040000

Plug-in spare arrester: PU I 0 TSG+ 350V 1,5kV – 8960520000
---

**Class I lightning arrester**

- This space-saving, encapsulated lightning arrester can switch mains follow currents and discharge currents of max. 50 kA (10/350 µs). It enables installations in protective classes I and II.
- High degree of protection against short circuits, with max. back-up fuse of 50 kA. This ensures safe installations anywhere around the globe.
- The pluggable arrester always guarantees proper readability. It also ensures that the shortest path is taken to the system's earth potential.
- The arrester's status display enables defective modules to be quickly located and replaced. The status can also be forwarded on to the control room by means of the remote alarm signals.
- The low protection level (1.5 kV) increases the dielectric strength in the main distributor; as a result, the connected devices are not damaged.

**PU I 1+1 TSG+ 350 V 1,5 kV**

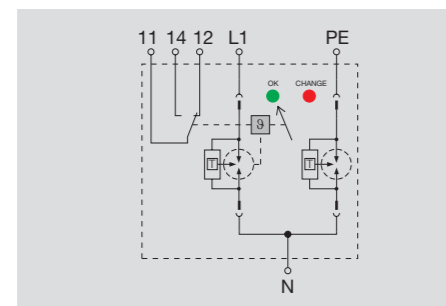

**PU I 1 TSG+ 350 V 1,5 kV**

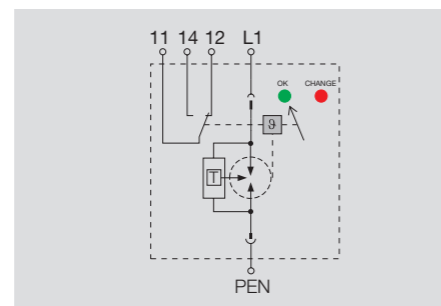

**Technical data**

Control side	
Rated voltage (AC)	240 V / 415 V
Max. continuous voltage, U <sub>c</sub> (AC)	350 V
Temporary surge - U <sub>TV</sub>	415 V
Requirement category acc. to IEC 61643-1	Class I
Rated discharge current I <sub>imp</sub> (10/350 µs) [L-PE]	25 kA
Rated discharge current I <sub>imp</sub> (10/350 µs) [N-PE]	100 kA
Specific energy, per path	160 kJ/Ohm
Short-circuit strength with max. back-up fuse	50 kA
PE current I <sub>pe</sub> at U <sub>c</sub>	< 0,01 mA
Response time	≤ 100 ns
Fuse, max.	315 A gI
Protection level Up (typical)	1,5 kV
Optical function indicator:	green = OK; red = arrester faulty, replace
Signalling contact	1 CO 250 V AC, 1 A / 125 V DC, 30 mA
Connection torque range	4...4,5 Nm
Design	Insta
Ambient temperature (operational)	-40 °C...+80 °C
Storage temperature	-40 °C...+80 °C
Standards	IEC61643-1, EN61643-11

240 V / 415 V
350 V
415 V
Class I
25 kA
100 kA
160 kJ/Ohm
50 kA
< 0,01 mA
≤ 100 ns
315 A gI
1,5 kV
green = OK; red = arrester faulty, replace
1 CO 250 V AC, 1 A / 125 V DC, 30 mA
4...4,5 Nm
Insta
-40 °C...+80 °C
-40 °C...+80 °C
IEC61643-1, EN61643-11

240 V
350 V
415 V
Class I
25 kA
160 kJ / Ohm
50 kA
< 0,01 mA
≤ 100 ns
315 A gI
1,5 kV
green = OK; red = arrester faulty, replace
1 CO 250 V AC, 1 A / 125 V DC, 30 mA
4...4,5 Nm
Insta
-40 °C...+80 °C
-40 °C...+80 °C
IEC61643-1, EN61643-11

**Dimensions**

Clamping range (rating- / min. / max.)	mm <sup>2</sup>	25 / 2,5 / 35
Length x Width x Height	mm	97 x 72 x 72,5

25 / 2,5 / 35
97 x 72 x 72,5

25 / 2,5 / 35
97 x 36 x 72,5

**Ordering data**

Type	Qty.	Order No.
PU I 1+1 TSG+ 350V 1,5kV	1	8960500000

Type	Qty.	Order No.
PU I 1+1 TSG+ 350V 1,5kV	1	8960500000

Type	Qty.	Order No.
PU I 1 TSG+ 350V 1,5kV	1	8960480000

**Accessories**

Plug-in spare arrester: PU I 0 TSG+ 350V 1,5kV – 8960520000
Plug-in spare arrester: PU I 0 N/PE TSG+ 350V – 1066040000

Plug-in spare arrester: PU I 0 TSG+ 350V 1,5kV – 8960520000
Plug-in spare arrester: PU I 0 N/PE TSG+ 350V – 1066040000

Plug-in spare arrester: PU I 0 TSG+ 350V 1,5kV – 8960520000
---



# Surge protection for low-voltage supplies

<b>Surge protection for low-voltage supplies</b>	Quick selection guide	C.2
	Surge protection class I	C.6
	Class I with sparkover gaps	C.8
	Class I and II with lightning arrester	C.13
	Combination arrester	C.18
	Class II with varistors	C.22
	Surge monitoring module	C.42
	Class III with varistors	C.44
	Class III adapter plug	C.50
	Mains filter	C.56
	Installation specification	C.60
	Application examples in 230/400 V networks can be found on the fold-out cover	

C



# Product quick selection, power supply Class I

## Combination arresters – class I

Product	Version	Rated	Discharge capacity capacity Iimp (10/350)	Protection level Up	Follow current suppression suppression capability I <sub>fi</sub>	Tele-communication contact	Max. backup fuse A gl/gG	Overall width	Order No.
PU Combi 4 wire	4-pole	260 V	100 kA	1.5 kV	3 kA		125	6 module	8729960000
PU_R Combi 4 wire	4-pole	260 V	100 kA	1.5 kV	3 kA	1 W	125	7 module	8729970000
PU Combi 5 wire	5-pole	260 V	100 kA	1.5 kV	3 kA		125	8 module	8729950000
PU_R Combi 5 wire	5-pole	260 V	100 kA	1.5 kV	3 kA	1 W	125	9 module	8729930000
PU BC 16 kA	single-pole	280 V	16 kA	< 1.3 kV	no system follow current		160	2 module	8805440000
PU BCR 16 kA	single-pole	280 V	16 kA	< 1.3 kV	no system follow current	1 W	160	3 module	8805450000

## Lightning arresters – class I sparkover gaps (intermediate meter area)

Product	Version	Rated voltage Uc	Discharge capacity capacity Iimp (10/350)	Protection level Up	Follow current suppression suppression capability I <sub>fi</sub>	blow-out/ encapsulated	Max. backup fuse A gl/gG	Overall width	Order No.
PU 1 TSG 35 kA/0.9 kV	single-pole	260 V	35 kA	900 V	3 kA	encapsulated	125	1 module	8561260000
PU 1 TSG+ 50 kA/0.9 kV	single-pole	330 V	50 kA	900 V	50 kA	blow-out	250	2 module	8561220000
PU 1 TSG+ 50 kA/1.5kV	single-pole	440 V	50 kA	1.5 kV	50 kA	blow-out	250	2 module	8561250000

## N-PE lightning arresters – class I sparkover gaps (intermediate meter area)

Product	Version	Rated voltage Uc	Discharge capacity capacity Iimp (10/350)	Protection level Up	Follow current suppression suppression capability I <sub>fi</sub>	blow-out / encapsulated	Max. backup fuse A gl/gG	Overall width	Order No.
PU 1 TSG 50 kA/1.5 kV	single-pole	260 V	50 kA	1.5 kV	500 A	encapsulated	125	1 module	8561230000
PU 1 TSG 100 kA/1.5 kV	single-pole	280 V	100 kA	1.5 kV	100 A	encapsulated	125	2 module	8762020000

## Lightning arresters – class I high-power varistors (after meter)

Product	Version	Rated voltage Uc	Discharge capacity capacity Iimp (10/350)	Protection level Up	Follow current suppression suppression capability I <sub>fi</sub>	Protection level at Ip	Max. backup fuse A gl/gG	Overall width	Order No.
PU BC 16kA	single-pole	280 V	16 kA	2 kV	60 kA	< 1.3 kV	160	2 module	8805440000
PU BC R 16kA	single-pole	280 V	16 kA	2 kV	60 kA	< 1.3 kV	160	3 module	8805450000
PU I 3 280 V/12.5 kA	3-pole	280 V	12.5 kA	1.3 kV	50 kA	< 1.3 kV	125	3 module	8858990000
PU I 3 R 280 V/12.5 kA	3-pole	280 V	12.5 kA	1.3 kV	50 kA	< 1.3 kV	125	3 module	8859010000
PU I 4 280 V/12.5 kA	4-pole	280 V	12.5 kA	1.3 kV	50 kA	< 1.3 kV	125	4 module	8859000000
PU I 4 R 280 V/12.5 kA	4-pole	280 V	12.5 kA	1.3 kV	50 kA	< 1.3 kV	125	4 module	8859020000

# Product quick selection, power supply Class II

Surge protection for  
low-voltage supplies

## Surge arrester - class II

Product	Version	Rated voltage	Rated discharge current In (8/20)	Protection level Up (typ.)	Max. discharge current I <sub>max</sub> (8/20)	Max. backup fuse	Tele-communication contact	Overall width	Order No.
		U <sub>c</sub>				A gl/gG			
PU II 1 280V/40kA	single-pole,separable	280 V	20 kA	1.4 kV	40 kA	125		1 module	8859690000
PU II 1 R 280V/40kA	single-pole,separable	280 V	20 kA	1.4 kV	40 kA	125	1 W	1 module	8859700000
PU II 1+1 280V/40kA	2-pole,separable	280 V	20 kA	1.4 kV	40 kA	125		2 module	8859730000
PU II 1+1R 280V/40kA	2-pole,separable	280 V	20 kA	1.4 kV	40 kA	125	1 W	2 module	8859740000
PU II 2 280V/40kA	2-pole,separable	280 V	20 kA	1.4 kV	40 kA	125		2 module	8859680000
PU II 2 R 280V/40kA	2-pole,separable	280 V	20 kA	1.4 kV	40 kA	125	1 W	2 module	8859670000
PU II 3 280V/40kA	3-pole,separable	280 V	20 kA	1.4 kV	40 kA	125		3 module	8859630000
PU II 3 R 280V/40kA	3-pole,separable	280 V	20 kA	1.4 kV	40 kA	125	1 W	3 module	8859650000
PU II 4 280V/40kA	4-pole,separable	280 V	20 kA	1.4 kV	40 kA	125		4 module	8859640000
PU II 4 R 280V/40kA	4-pole,separable	280 V	20 kA	1.4 kV	40 kA	125	1 W	4 module	8859660000
PU II 3+1 280V/40kA	4-pole,separable	280 V	20 kA	1.4 kV	40 kA	125		4 module	8859710000
PU II 3+1R 280V/40kA	4-pole,separable	280 V	20 kA	1.4 kV	40 kA	125	1 W	4 module	8859720000
PU II 3 LCF 280V/40kA	3-pole,separable	280 V	20 kA	1.4 kV	40 kA	125		3 module	8859760000
PU II 3 R LCF 280V/40kA	3-pole,separable	280 V	20 kA	1.4 kV	40 kA	125	1 W	3 module	8859780000
PU II 4 LCF 280V/40kA	4-pole,separable	280 V	20 kA	1.4 kV	40 kA	125		3 module	8859770000
PU II 4 R LCF 280V/40kA	4-pole,separable	280 V	20 kA	1.4 kV	40 kA	125	1 W	4 module	8859790000
PU II 3 EWS 280V/40kA	3-pole,separable	280 V	20 kA	1.4 kV	40 kA	125		3 module	8859800000
PU II 3 R EWS 280V/40kA	3-pole,separable	280 V	20 kA	1.4 kV	40 kA	125	1 W	3 module	8859820000
PU II 4 EWS 280V/40kA	4-pole,separable	280 V	20 kA	1.4 kV	40 kA	125		4 module	8859810000
PU II 4 R EWS 280V/40kA	4-pole,separable	280 V	20 kA	1.4 kV	40 kA	125	1 W	4 module	8859830000
PU II 0 280V/40kA	spare plug	280 V	20 kA	1.4 kV	40 kA	125			8859750000
PU II 0 N-PE 280V/40kA	spare plug	280 V							8871940000
PU II 1 75V/40kA	single-pole,separable	75 V	20 kA	0.7 kV	40 kA	125		1 module	8860150000
PU II 1 R 75V/40kA	single-pole,separable	75 V	20 kA	0.7 kV	40 kA	125	1 W	1 module	8860160000
PU II 2 75V/40kA	2-pole,separable	75 V	20 kA	0.7 kV	40 kA	125		2 module	8860130000
PU II 2 R 75V/40kA	2-pole,separable	75 V	20 kA	0.7 kV	40 kA	125	1 W	2 module	8860140000
PU II 0 75V/40kA	spare plug	75 V	20 kA	0.7 kV	40 kA	125			8871950000
PU II 1 130V/40kA	single-pole,separable	130 V	20 kA	0.8 kV	40 kA	125		1 module	8859950000
PU II 1 R 130V/40kA	single-pole,separable	130 V	20 kA	0.8 kV	40 kA	125	1 W	1 module	8859960000
PU II 2 130V/40kA	2-pole,separable	130 V	20 kA	0.8 kV	40 kA	125		2 module	8859970000
PU II 2 R 130V/40kA	2-pole,separable	130 V	20 kA	0.8 kV	40 kA	125	1 W	2 module	8859980000
PU II 3 130V/40kA	3-pole,separable	130 V	20 kA	0.8 kV	40 kA	125		3 module	8859990000
PU II 3 R 130V/40kA	3-pole,separable	130 V	20 kA	0.8 kV	40 kA	125	1 W	3 module	8860000000
PU II 4 130V/40kA	4-pole,separable	130 V	20 kA	0.8 kV	40 kA	125		4 module	8860010000
PU II 4 R 130V/40kA	4-pole,separable	130 V	20 kA	0.8 kV	40 kA	125	1 W	4 module	8860020000
PU II 0 130V/40kA	spare plug	130 V	20 kA	0.8 kV	40 kA	125			8860030000
PU II 3 385V/40kA	3-pole,separable	385 V	20 kA	1.8 kV	40 kA	125		3 module	8859840000
PU II 3 R 385V/40kA	3-pole,separable	385 V	20 kA	1.8 kV	40 kA	125	1 W	3 module	8859850000
PU II 4 385V/40kA	4-pole,separable	385 V	20 kA	1.8 kV	40 kA	125		4 module	8859860000
PU II 4 R 385V/40kA	4-pole,separable	385 V	20 kA	1.8 kV	40 kA	125	1 W	4 module	8859870000
PU II 3+1 385V/40kA	4-pole,separable	385 V	20 kA	1.8 kV	40 kA	125		4 module	8859880000
PU II 3+1R 385V/40kA	4-pole,separable	385 V	20 kA	1.8 kV	40 kA	125	1 W	4 module	8859890000
PU II 0 385V/40kA	spare plug	385 V	20 kA	1.8 kV	40 kA	125			

## Surge arrester - class II

Product	Version	Rated voltage	Rated discharge current In (8/20)	Protection level Up (typ.)	Max. discharge current I <sub>max</sub> (8/20)	Max. backup fuse	Tele-communication contact	Overall width	Order No.
		U <sub>c</sub>				A gl/gG			
PU II 1 550V/40kA	single-pole,separable	550 V	20 kA	2.6 kV	40 kA	125		1 module	8860040000
PU II 1 R 550V/40kA	single-pole,separable	550 V	20 kA	2.6 kV	40 kA	125	1 W	1 module	8860050000
PU II 2 550V/40kA	2-pole,separable	550 V	20 kA	2.6 kV	40 kA	125		2 module	8860100000
PU II 2 R 550V/40kA	2-pole,separable	550 V	20 kA	2.6 kV	40 kA	125	1 W	2 module	8860110000
PU II 3 550V/40kA	3-pole,separable	550 V	20 kA	2.6 kV	40 kA	125		3 module	8860080000
PU II 3 R 550V/40kA	3-pole,separable	550 V	20 kA	2.6 kV	40 kA	125	1 W	3 module	8860090000
PU II 4 550V/40kA	4-pole,separable	550 V	20 kA	2.6 kV	40 kA	125		4 module	8860060000
PU II 4 R 550V/40kA	4-pole,separable	550 V	20 kA	2.6 kV	40 kA	125	1 W	4 module	8860070000
PU II 2+1 550V/40kA	3-pole,separable	550 V	20 kA	2.6 kV	40 kA	125		3 module	8882340000
PU II 2+1R 550V/40kA	3-pole,separable	550 V	20 kA	2.6 kV	40 kA	125	1 W	3 module	8882350000
PU II 0 550V/40kA	spare plug	550 V	20 kA	2.6 kV	40 kA	125			8860120000



# Product quick selection, power supplies

## Class III

### Surge arrester - class III

Product	Version	Rated voltage	Rated discharge current In (8/20)	Protection level Up (typ.)	Max. discharge current I <sub>max</sub> (8/20)	Max. backup fuse A gI/gG	Tele-communication contact	Overall width	Order No.
PU III R 12V/4kV	single-pole, DIN rail	15 V	2 kA	0.2 kV	7 kA	16	1 W	1 module	<b>8883740000</b>
PU III R 24V/4kV	single-pole, DIN rail	30 V	2 kA	0.3 kV	7 kA	16	1 W	1 module	<b>8860360000</b>
PU III R 48V/4kV	single-pole, DIN rail	60 V	2 kA	0.3 kV	6.5 kA	16	1 W	1 module	<b>8860350000</b>
PU III R 120V/6kV	single-pole, DIN rail	130 V	3 kA	0.7 kV	5 kA	16	1 W	1 module	<b>8860340000</b>
PU III R 230V/6kV	single-pole, DIN rail	280 V	3 kA	1.3 kV	5 kA	16	1 W	1 module	<b>8860330000</b>
PO DS 230 V	2-pole, for device mounting	275 V	2.5 kA	1.5 kV	5 kA	16			<b>8581830000</b>
PO DAS 230 V	2-pole, for device mounting with audible signal	275 V	2.5 kA	1.5 kV	5 kA	16	audible signal		<b>8581840000</b>



Surge protection for  
low-voltage supplies

C



## Surge protection class I with spark gap

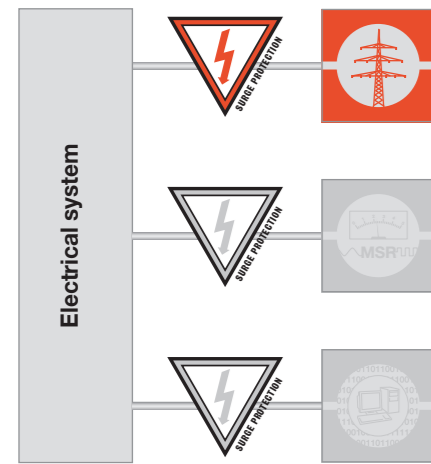

Weidmüller surge protection products from the PU 1 series (Class I), PU 1 TSG, PU II series (Class II), PU III series and PO D (Class III) effectively reduce the surge protection even below the limits prescribed by the insulation coordination according to DIN VDE 0110. This means that the entire system is subjected to less interference.

The coordination of the arresters is achieved by technical means. This means that decoupling between classes I, II and III is **not** necessary.

### Design surge voltage

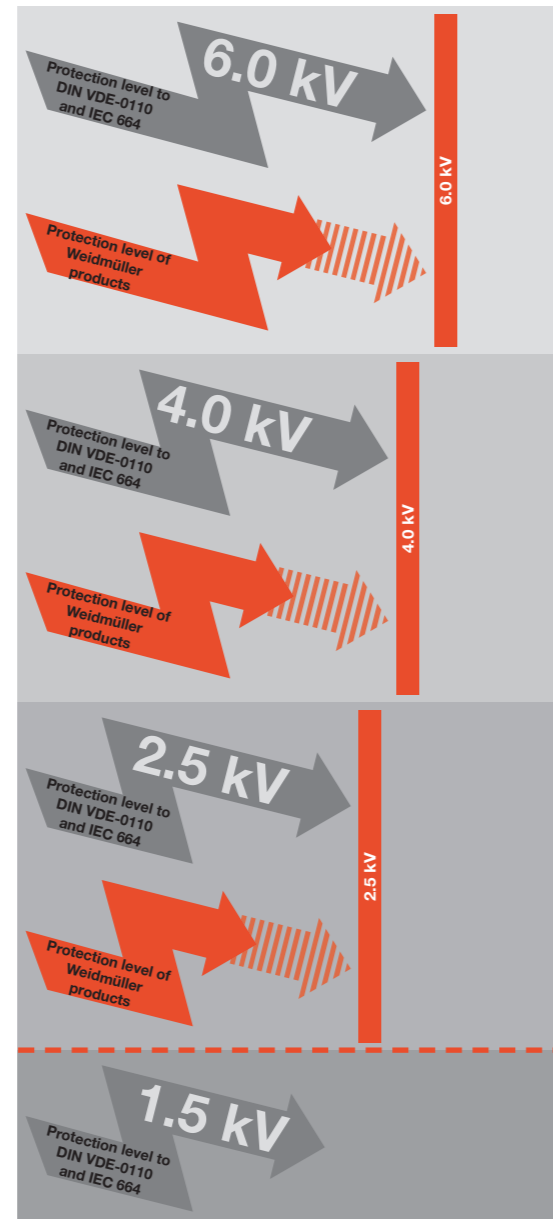

Class I



Class II



Class III



for insulation coordination to IEC 664 and DIN VDE 0110

**Surge arresters Class I**

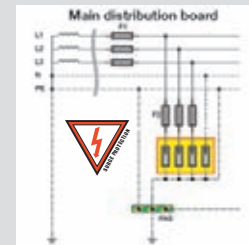

Lightning arrester/combi-arrester varistor-based on and enclosed 50/200 kA	PU I / PU BC	<b>Page C.11</b>
Sparkover gaps, triggered and enclosed, 35/50 kA	PU 1 TSG	<b>Page C.14</b>
Sparkover gaps, triggered 50 kA	PU 1 TSG+	<b>Page C.16</b>
Sparkover gaps, triggered and enclosed 100 kA	PU 1 TSG 100 kA	<b>Page C.15</b>
Combined surge protection	PU COMBI I + II	<b>Page C.20</b>
Replacement arrester, dependent on rated voltages	PU I 0 series	

**Surge arresters Class II**

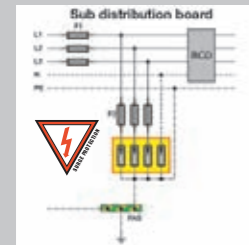

Varistor arresters up to 160 kA for diverse voltages	PU II series	<b>Page C.24</b>
Varistor arresters up to 160 kA for diverse voltages, with signalling contact	PU II R series	<b>Page C.24</b>
Replacement varistor to suit rated voltage	PU 0 II series	<b>Page C.24</b>

**Surge arresters Class III**

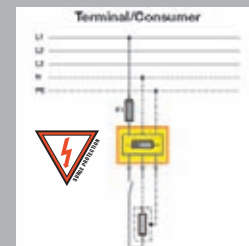

Single-phase arresters for diverse voltages, with signalling contact	PU III series	<b>Page C.45</b>
Three-phase arresters with signalling contact	PU 3 D	<b>Page C.49</b>
Schuko plug-in surge protector	PU D ZS	<b>Page C.51</b>

# Class I

## Lightning and surge protection for Class I with varistor technology: PU I

Weidmüller's PU I Series features Class I surge protection with varistor technology, and a discharge current capability of 12.5 kA (10/350  $\mu$ s). The pluggable, self-monitoring surge arresters are optionally available as 1-, 3- or 4-pole versions – with or without a remote signalling contact. PU I devices can be rotated 180° and thus simplify installation in RCDs with cross-connectors. Their ability to rotate allows you to implement PE connections over short distances.

### The advantages for you:

- Rotate 180° and remote signalling function
- Suitable for various types of mains voltages (TN/TT)
- Tested in compliance with IEC 61643-1 and EN 61643-11
- Convenient installation in sub-distribution boards and electrical cabinets
- Designed for use in buildings which comply with the lightning protection zones III/IV
- Very low residual voltage (<1.3 kV), thus also suitable as Class II surge protection

## Lightning conductors with sparkover gap for lightning protection or equipotential bonding providing Surge protection class I

According to the requirements of class B (DIN VDE 0675 part 6, draft: Nov. 1989/A1: Mar. 1996) and class I to IEC 61643-1 (Jan. 2002), the lightning conductor at the transfer from interface 0 to 1 (to IEC 1312-1) is used as the lightning protection providing equipotential bonding. In combination with several lightning protectors, the surge protection is used in the mains forms TN, TT and IT. When lightning strikes, the triggered air gap protector provides the necessary equipotential bonding between the building lightning protection and the earthing system of the power supply. The use of a sparkover gap satisfies the inspection requirements for class I surge protection systems according to the VDEW (Association of German Power Stations) directive (1st ed., 1998).



**Electrical connection for building installation**

The PU 1 TSG 35 kA class I lightning arrester is connected between the phase conductors (L1, L2, L3) and N/PE. A Weidmüller PU 1 TS G 50 kA is used to provide the N-PE sparkover gap. The lines for this should be kept as short as possible. The triggered and non-blowout PU 1 TSG devices can be clipped to TS 35 rails in electrical cabinets or distribution boards. The maximum permissible operating voltage  $U_c$  is 260 V AC. Decoupling from downstream class II (C) arresters is unnecessary because triggered sparkover gaps with a low sparkover voltage are used.

Please follow the installation instructions.

**Electrical connection for industrial installations**

The PU 1 TSG+ 50 kA/330 V or 440 V class I lightning arrester is connected between the phase conductors (L1, L2, L3) and N/PE. A Weidmüller PU 1 TSG 50 kA is used to provide the N-PE sparkover gap. The lines for this should be kept as short as possible.

The triggered and blowout PU 1 TSG+ 50 kA devices can be clipped to TS 35 rails in electrical cabinets or distribution boards. Owing to the emissions given off when the sparkover gap is tripped, a safety clearance of min. 100 mm must be maintained between this and any current-conducting components.

**Coordination**

The maximum permissible operating voltage  $U_c$  is 330 or 440 V AC. Decoupling from downstream class II (C) arresters is unnecessary because triggered sparkover gaps with a low sparkover voltage are used.

**Important:** for  $U_c$  330 V, PU II is used with 280 V and for  $U_c$  440 V, the PU II with 550 V.

Please follow the installation instructions.

**Checking operation, maintenance and approvals**

A visual check is necessary to ensure that PU 1 TSG and PU 1 TSG+ surge protection components are operating correctly. Besides signalling a mains power failure, the LED illuminates above 120 V AC to indicate the failure of the firing electronics. It is advisable to check frequently during stormy weather.

The use of triggered sparkover gaps achieves a very low protection level of < 1.5 kV with high discharge currents. Depending on the cross-section of the line, the PU 1 TSG must be protected with a fuse of max. 125 A gL, the PU 1 TSG+ max. 250 A gL.

The connection is designed for the following cross-sections:

- solid wire: 10 ... 35 mm<sup>2</sup>
- stranded wire: 10 ... 25 mm<sup>2</sup>

The operating temperature range is –40 °C ... +85 °C.

The PU 1 TSG lightning arresters have UL and KEMA approval and are hence suitable for use worldwide.

C

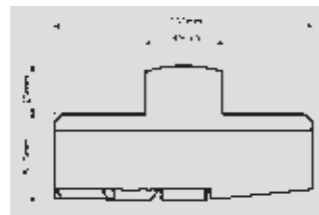

**Dimensions PU 1 TSG+**  
Overall width 36 mm

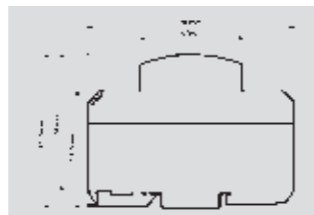

**Dimensions PU 1 TSG**  
Overall width 18 mm

**Class I with sparkover gaps**

**Protection in the TN-S-system**

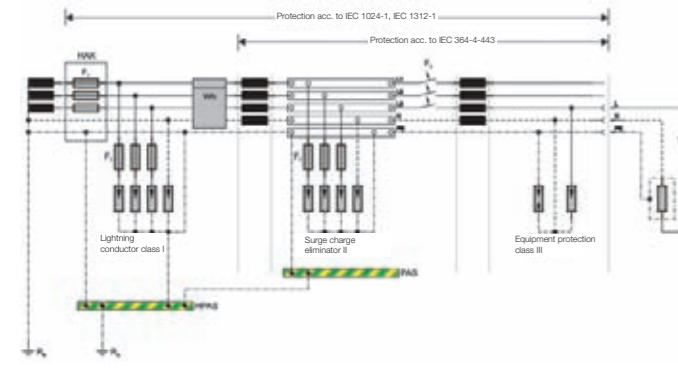

**Protection in the TT-system**

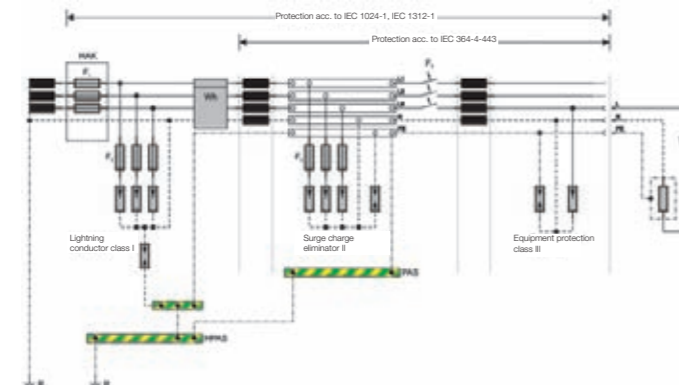

In contrast to conventional sparkover gaps, the Weidmüller PU 1 TSG+ and PU 1 TSG sparkover gaps operate with electronic triggering. This fires the sparkover gap at such an early point that the downstream class II (PU II series) arresters are relieved. Decoupling from downstream class II (C) arresters is unnecessary because triggered sparkover gaps with a low sparkover voltage are used.

The PU 1 TSG+ and PU 1 TSG differ in terms of the follow current extinction. The PU 1 TSG+ distributes the arc drop voltage over several chambers. As soon as the total arc drop voltage exceeds the mains voltage flowing, the follow current is extinguished. In the PU 1 TSG the follow current extinction takes place at the next current zero of the mains voltage.

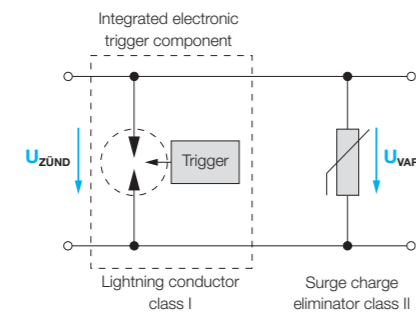
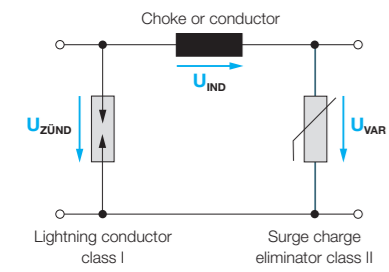

**Accessories for PU BC / BCR / PU1TSG**

	Type	Qty.	Order No.
N-PE Arrester	PU1TSG	1	8561230000
Cross-connection for 3 units PU BC	QB 36-3	1	8816090000
Cross-connection for 4 units PU BC	QB 36-4	1	8816100000
Cross-connection for 3 units PU BCR	QB 54-3	1	8821720000
Cross-connection for 4 units PU BCR	QB 54-4	1	8821710000
Cross-connection for 3 units PU BC+PU1TSG	QB 36-3+1	1	8858360000
Cross-connection for 3 units PU BCR+PU1TSG	QB 54-3+1	1	8858340000
Cross-connection for 1 unit PU BC/R+PU1TSG	QB 36-1+1	1	8858350000



**Class I + II lightning arrester**

Combi-arrester

- Class I + II plug-in arrester for lightning protection equipotential bonding
- Suitable for lightning protection classes III and IV
- High discharge current with 12.5 kA (10/350 μs)
- Low residual voltage from <1.3 kV, thus also can be used for Class II surge protection
- High-power varistor, non-blow-out arrester
- No decoupling to class II and III arresters necessary
- Follow current need not be taken into account

**PU I 4/R 280V/12,5kA**

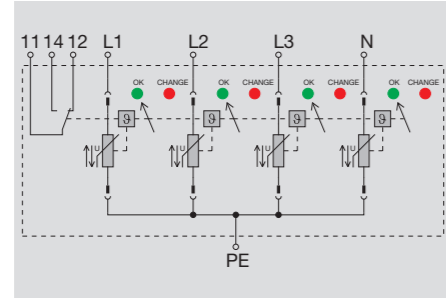

**PU I 3/R 280V/12,5kA**

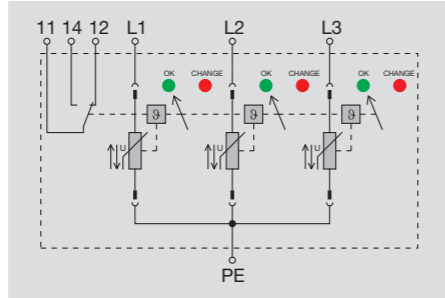

Surge protection for low-voltage supplies



**Technical data**

<b>Technical data</b>	
Rated voltage (AC)	230 V
max. continuous voltage, U <sub>c</sub> (AC)	280 V
Requirements class to IEC 61643-1	I+II (combination arrester)
Lightning test voltage I imp (10/350 μs)	12.5 kA
Charge, typical	6 As
Specific energy, per path	45 kJ/Ω
Short-circuit current extinction without back-up fuse	6 As
Short-circuit strength with max. back-up fuse	25 kA <sub>eff</sub>
Response time	≤ 25 ns
Fuse, max.	160 A gL
Protection level Up (typical)	< 1300 V
Optical function indicator	green = OK; red = arrester faulty, replace
Signalling contact	250 V 1A 1CO at PU I 4 R
Tightening torque range	2.5 Nm...3 Nm
Discharge current, max. (8/20 μs)	50 kA
Rated discharge current per path (8/20 μs)	30 kA
Temporary surge - U <sub>TCV</sub>	335 V
Design	4 unit widths; installation housing
Ambient temperature (operational)	-40 ... 70°C
Storage temperature	-40 ... 70°C
Approvals	CE

<b>PU I 4/R 280V/12,5kA</b>	
Rated voltage (AC)	230 V
max. continuous voltage, U <sub>c</sub> (AC)	280 V
Requirements class to IEC 61643-1	I+II (combination arrester)
Lightning test voltage I imp (10/350 μs)	12.5 kA
Charge, typical	6 As
Specific energy, per path	45 kJ/Ω
Short-circuit current extinction without back-up fuse	6 As
Short-circuit strength with max. back-up fuse	25 kA <sub>eff</sub>
Response time	≤ 25 ns
Fuse, max.	160 A gL
Protection level Up (typical)	< 1300 V
Optical function indicator	green = OK; red = arrester faulty, replace
Signalling contact	250 V 1A 1CO at PU I 4 R
Tightening torque range	2.5 Nm...3 Nm
Discharge current, max. (8/20 μs)	50 kA
Rated discharge current per path (8/20 μs)	30 kA
Temporary surge - U <sub>TCV</sub>	335 V
Design	4 unit widths; installation housing
Ambient temperature (operational)	-40 ... 70°C
Storage temperature	-40 ... 70°C
Approvals	CE

<b>PU I 3/R 280V/12,5kA</b>	
Rated voltage (AC)	230 V
max. continuous voltage, U <sub>c</sub> (AC)	280 V
Requirements class to IEC 61643-1	I+II (combination arrester)
Lightning test voltage I imp (10/350 μs)	12.5 kA
Charge, typical	6 As
Specific energy, per path	45 kJ/Ω
Short-circuit current extinction without back-up fuse	6 As
Short-circuit strength with max. back-up fuse	25 kA <sub>eff</sub>
Response time	≤ 25 ns
Fuse, max.	160 A gL
Protection level Up (typical)	< 1300 V
Optical function indicator	green = OK; red = arrester faulty, replace
Signalling contact	250 V 1A 1CO at PU I 3 R
Tightening torque range	2.5 Nm...3 Nm
Discharge current, max. (8/20 μs)	50 kA
Rated discharge current per path (8/20 μs)	30 kA
Temporary surge - U <sub>TCV</sub>	335 V
Design	3 unit widths; installation housing
Ambient temperature (operational)	-40 ... 70°C
Storage temperature	-40 ... 70°C
Approvals	CE

**Dimensions**

Clamping range (rating- / min. / max.)	mm <sup>2</sup>	25 / 4 / 25
Length x width x height	mm	90 x 72 x 64

<b>PU I 4/R 280V/12,5kA</b>		
Clamping range (rating- / min. / max.)	mm <sup>2</sup>	25 / 4 / 25
Length x width x height	mm	90 x 72 x 64

<b>PU I 3/R 280V/12,5kA</b>		
Clamping range (rating- / min. / max.)	mm <sup>2</sup>	25 / 4 / 25
Length x width x height	mm	90 x 54 x 64

**Ordering data**

Version	Type	Qty.	Order No.
	PU I 4 280V/12,5kA	1	8859000000
	PU I 4 R 280V/12,5kA	1	8859020000

Type	Qty.	Order No.
PU I 4 280V/12,5kA	1	8859000000
PU I 4 R 280V/12,5kA	1	8859020000

Version	Type	Qty.	Order No.
	PU I 3 280V/12,5kA	1	8858990000
	PU I 3 R 280V/12,5kA	1	8859010000

Additional rated voltages on request	
--------------------------------------	--

Additional rated voltages on request	
--------------------------------------	--

**Accessories**

Pluggable replacement arrester, PU I 0 280 V/12,5kA - 8859120000
--

Pluggable replacement arrester, PU I 0 280 V/12,5kA - 8859120000
--

Pluggable replacement arrester, PU I 0 280 V/12,5kA - 8859120000
--

## Class I with sparkover gaps

### Class I + II lightning arrester

Combi-arrester

- Class I + II plug-in arrester for lightning protection equipotential bonding
- Suitable for lightning protection classes III and IV
- High discharge current with 12.5 kA (10/350 μs)
- Low residual voltage from <1.3 kV, thus also can be used for Class II surge protection
- High-power varistor, non-blow-out arrester
- No decoupling to class II and III arresters necessary
- Follow current need not be taken into account

### PU I 2/R 280V/12,5kA



### PU I 1/R 280V/12,5kA

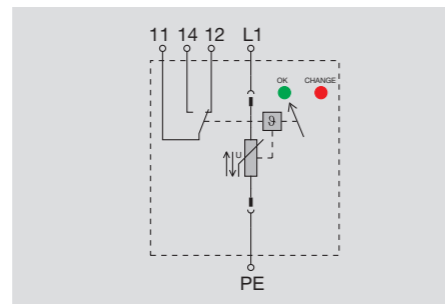
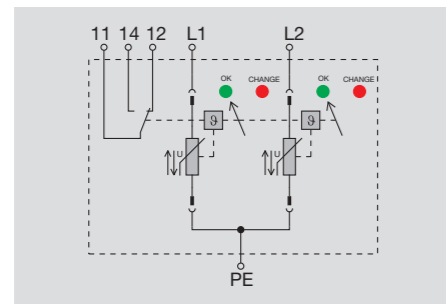

### Technical data

<b>Technical data</b>	
Rated voltage (AC)	230 V
max. continuous voltage, U <sub>c</sub> (AC)	280 V
Requirements class to IEC 61643-1	I+II (combination arrester)
Lightning test voltage I imp (10/350 μs)	12.5 kA
Charge, typical	6 As
Specific energy, per path	45 kJ/Ω
Short-circuit current extinction without back-up fuse	6 As
Short-circuit strength with max. back-up fuse	25 kA <sub>eff</sub>
Response time	≤ 25 ns
Fuse, max.	160 A gL
Protection level Up (typical)	< 1300 V
Optical function indicator	green = OK; red = arrester faulty, replace
Signalling contact	250 V 1 A 1CO at PU I 2 R
Tightening torque range	2.5 Nm...3 Nm
Discharge current, max. (8/20 μs)	50 kA
Rated discharge current per path (8/20 μs)	30 kA
Temporary surge - U <sub>TCV</sub>	335 V
Design	2 unit widths; installation housing
Ambient temperature (operational)	-40 ... 70°C
Storage temperature	-40 ... 70°C
Approvals	CE

<b>Technical data</b>	
Rated voltage (AC)	230 V
max. continuous voltage, U <sub>c</sub> (AC)	280 V
Requirements class to IEC 61643-1	I+II (combination arrester)
Lightning test voltage I imp (10/350 μs)	12.5 kA
Charge, typical	6 As
Specific energy, per path	45 kJ/Ω
Short-circuit current extinction without back-up fuse	6 As
Short-circuit strength with max. back-up fuse	25 kA <sub>eff</sub>
Response time	≤ 25 ns
Fuse, max.	160 A gL
Protection level Up (typical)	< 1300 V
Optical function indicator	green = OK; red = arrester faulty, replace
Signalling contact	250 V 1 A 1CO at PU I 1 R
Tightening torque range	2.5 Nm...3 Nm
Discharge current, max. (8/20 μs)	50 kA
Rated discharge current per path (8/20 μs)	30 kA
Temporary surge - U <sub>TCV</sub>	335 V
Design	1 unit width; installation housing
Ambient temperature (operational)	-40 ... 70°C
Storage temperature	-40 ... 70°C
Approvals	CE

<b>Technical data</b>	
Rated voltage (AC)	230 V
max. continuous voltage, U <sub>c</sub> (AC)	280 V
Requirements class to IEC 61643-1	I+II (combination arrester)
Lightning test voltage I imp (10/350 μs)	12.5 kA
Charge, typical	6 As
Specific energy, per path	45 kJ/Ω
Short-circuit current extinction without back-up fuse	6 As
Short-circuit strength with max. back-up fuse	25 kA <sub>eff</sub>
Response time	≤ 25 ns
Fuse, max.	160 A gL
Protection level Up (typical)	< 1300 V
Optical function indicator	green = OK; red = arrester faulty, replace
Signalling contact	250 V 1 A 1CO at PU I 1 R
Tightening torque range	2.5 Nm...3 Nm
Discharge current, max. (8/20 μs)	50 kA
Rated discharge current per path (8/20 μs)	30 kA
Temporary surge - U <sub>TCV</sub>	335 V
Design	1 unit width; installation housing
Ambient temperature (operational)	-40 ... 70°C
Storage temperature	-40 ... 70°C
Approvals	CE

### Dimensions

Clamping range (rating- / min. / max.)	mm <sup>2</sup>	25 / 4 / 25
Length x width x height	mm	90 x 36 x 64

Clamping range (rating- / min. / max.)	mm <sup>2</sup>	25 / 4 / 25
Length x width x height	mm	90 x 36 x 64

Clamping range (rating- / min. / max.)	mm <sup>2</sup>	25 / 4 / 25
Length x width x height	mm	90 x 18 x 64

### Note

### Ordering data

Version	Type	Qty.	Order No.
	PU I 2 280V/12,5kA	1	8859040000
	PU I 2 R 280V/12,5kA	1	8859030000

Version	Type	Qty.	Order No.
	PU I 2 280V/12,5kA	1	8859040000
	PU I 2 R 280V/12,5kA	1	8859030000

Version	Type	Qty.	Order No.
	PU I 1 280V/12,5kA	1	8859050000
	PU I 1 R 280V/12,5kA	1	8859060000

### Note

Additional rated voltages on request

Additional rated voltages on request

### Accessories

Note	Pluggable replacement arrester, PU I 0 280 V/12.5kA - 8859120000
------	--

Note	Pluggable replacement arrester, PU I 0 280 V/12.5kA - 8859120000
------	--

Note	Pluggable replacement arrester, PU I 0 280 V/12.5kA - 8859120000
------	--

**Class I + II lightning arrester**

- Class I + II plug-in arrester for lightning protection equipotential bonding
- Suitable for lightning protection classes II, III and IV
- High discharge current of 16 kA (10/350 μs) according to requirements of the VDE 0100-534 standard
- Low residual voltage from <1.3 kV, thus also can be used for Class II surge protection
- two pluggable high-power varistors with redundant functioning
- High-power varistor, non-blow-out arrester
- No decoupling to class II and III arresters necessary

**PU BC/BCR 16 kA / 280 V**

Can be used in all net-systems

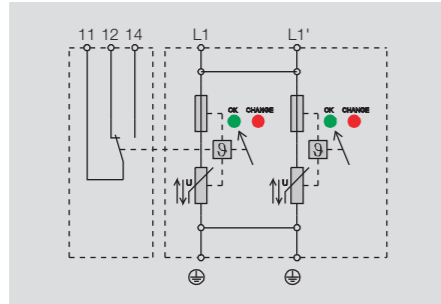

**Technical data**

<b>Technical data</b>	
Rated voltage (AC)	230 V
max. continuous voltage, Uc (AC)	280 V
Requirements class to IEC 61643-1	I+II (combination arrester)
Lightning test voltage I imp (10/350 μs)	16 kA
Charge, typical	
Specific energy, per path	64 kJ/Ω
Short-circuit current extinction without back-up fuse	
Short-circuit strength with max. back-up fuse	25 kA <sub>eff</sub>
Response time	≤ 25 ns
Fuse, max.	160 A gL
Protection level Up (typical)	1300 V
Optical function indicator	green = OK; red = arrester faulty, replace
Signalling contact	250 V 1A 1CO at PU BCR
Tightening torque range	4.5 Nm
Discharge current, max. (8/20 μs)	60 kA
Rated discharge current per path (8/20 μs)	
Temporary surge - U <sub>TOV</sub>	335 V
Design	Installation housing
Ambient temperature (operational)	-40 ... 60°C
Storage temperature	-40 ... 80°C
Approvals	CE

<b>Dimensions</b>		<b>without telecomm. contact</b>	<b>with telecomm. contact</b>
Clamping range (rating- / min. / max.)	mm²	10 / 6 / 50	10 / 6 / 50
Length x width x height	mm	90 x 36 x 61	90 x 54 x 61

<b>Note</b>	
-------------	--

**Ordering data**

Version	Type	Qty.	Order No.
without telecomm. contact	PU BC 16kA/280V	1	8805440000
with telecomm. contact	PU BCR 16kA/280V	1	8805450000

<b>Note</b>	
-------------	--

**Accessories**

<b>Note</b>	Plug-in spare arrester PU 0 BC 280 V: 8805470000 Cross-connectors see F.12
-------------	---

Surge protection for low-voltage supplies

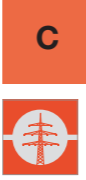

**Class I + II with lightning arrester**

**Class I lightning arrester**

- encapsulated version
- no decoupling necessary thanks to trigger electronics
- Suitable for lightning protection classes I, II, III, IV.

**PU 1 TSG 35 kA / 0,9 kV-260 V**

for use in building systems (L-N/PE)

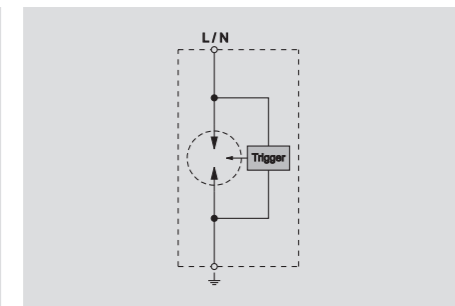

**PU 1 TSG 50 kA / 1,5 kV-260 V**

for use in building systems (N-PE)

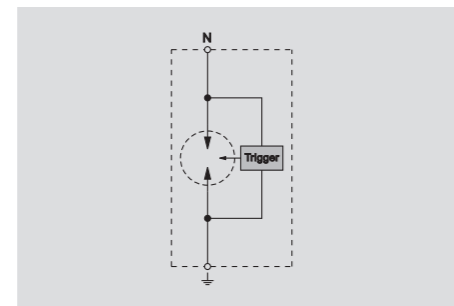

**Technical data**

Rated voltage (AC)	230 V
max. continuous voltage, Uc (AC)	260 V
Requirements class to IEC 61643-1	Class I
Lightning test voltage I imp (10/350 µs)	35 kA with 17.5 As charge
Specific energy, per path	305 kJ/Ω
Short-circuit current extinction without back-up fuse	3 kA / 50 Hz
Short-circuit strength with max. back-up fuse	25 kA <sub>eff</sub>
Response time	≤ 1 µs
Fuse, max.	125 A gL
Protection level Up (typical)	900 V
Optical function indicator	green LED
Ambient temperature (operational)	-40 ... 85°C
Storage temperature	-40 ... 85°C
Approvals	CE

Rated voltage (AC)	230 V
max. continuous voltage, Uc (AC)	260 V
Requirements class to IEC 61643-1	Class I
Lightning test voltage I imp (10/350 µs)	50 kA with 25 As charge
Specific energy, per path	625 kJ/Ω
Short-circuit current extinction without back-up fuse	500 A / 50 Hz
Short-circuit strength with max. back-up fuse	25 kA <sub>eff</sub>
Response time	≤ 1 µs
Fuse, max.	125 A gL
Protection level Up (typical)	1500 V
Optical function indicator	no
Ambient temperature (operational)	-40 ... 85°C
Storage temperature	-40 ... 85°C
Approvals	CE

Rated voltage (AC)	230 V
max. continuous voltage, Uc (AC)	260 V
Requirements class to IEC 61643-1	Class I
Lightning test voltage I imp (10/350 µs)	50 kA with 25 As charge
Specific energy, per path	625 kJ/Ω
Short-circuit current extinction without back-up fuse	500 A / 50 Hz
Short-circuit strength with max. back-up fuse	25 kA <sub>eff</sub>
Response time	≤ 1 µs
Fuse, max.	125 A gL
Protection level Up (typical)	1500 V
Optical function indicator	no
Ambient temperature (operational)	-40 ... 85°C
Storage temperature	-40 ... 85°C
Approvals	CE

**Dimensions**

Clamping range (rating- / min. / max.)	mm²	35 / 10 / 35
Length x width x height	mm	91 x 18 x 63

Clamping range (rating- / min. / max.)	mm²	35 / 10 / 35
Length x width x height	mm	91 x 18 x 63

Clamping range (rating- / min. / max.)	mm²	35 / 10 / 35
Length x width x height	mm	91 x 18 x 63

**Ordering data**

Version	Type	Qty.	Order No.
without telecomm. contact	PU 1 TSG 35kA / 0,9kV	1	8561260000

Type	Qty.	Order No.
PU 1 TSG 35kA / 0,9kV	1	8561260000
Cross-connection QB 18-4 order No. 8619440000		
Cross-connection QB 18-6 order No. 8619450000		

Type	Qty.	Order No.
PU 1 TSG 50kA / 1,5kV	1	8561230000
Cross-connection QB 18-4 order No. 8619440000		
Cross-connection QB 18-6 order No. 8619450000		

**Accessories**

Note	Designation BZ18, L1 L2 L3 N PE, order No. 8619460000
------	---

Note	Designation BZ18, L1 L2 L3 N PE, order No. 8619460000
------	---

Note	Designation BZ18, L1 L2 L3 N PE, order No. 8619460000
------	---

**Class I lightning arrester**

- encapsulated version
- no decoupling necessary thanks to trigger electronics
- Suitable as N-PE arrester
- Suitable for lightning protection classes I, II, III, IV.

**PU 1 TSG+ 100 kA / 1,5 kV-260 V**

for use as N-PE arrester

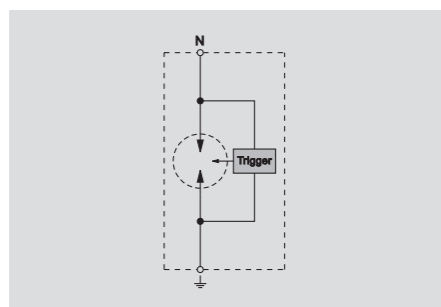

**Technical data**

Rated voltage (AC)	230 V
max. continuous voltage, Uc (AC)	260 V
Requirements class to IEC 61643-1	Class I
Lightning test voltage I imp (10/350 μs)	100 kA with 50 As charge
Specific energy, per path	2500 kJ/Ω
Short-circuit current extinction without back-up fuse	100 A 260 V/50 Hz
Short-circuit strength with max. back-up fuse	
Response time	≤ 1 μs
Fuse, max.	100 A gL
Protection level Up (typical)	1500 V
Optical function indicator	no
Ambient temperature (operational)	-40 ... 85°C
Storage temperature	-40 ... 85°C
Approvals	CE

**Dimensions**

Clamping range (rating- / min. / max.)	mm²	50 / 6 / 50
Length x width x height	mm	90 x 36 x 63

**Note**

**Ordering data**

Version	Type	Qty.	Order No.
without telecomm. contact	PU 1 TSG 100kA/1,5 kV	1	8762020000

**Note**

Cross-connection QB 18-4 order No. 8619440000  
 Cross-connection QB 18-6 order No. 8619450000

**Accessories**

**Note**

Designation BZ18, L1 L2 L3 N PE, order No. 8619460000

Surge protection for low-voltage supplies



**Class I + II with lightning arrester**

**Class I lightning arrester**

- Blow-out version
- no decoupling necessary thanks to trigger electronics
- suitable for networks with high short-circuit currents
- suitable for lightning protection classes I, II, III, IV.

**PU 1 TSG+ 50 kA / 0,9 kV-330 V**

for use in industrial systems



**PU 1 TSG+ 50 kA / 1,5 kV-440 V**

for use in industrial systems

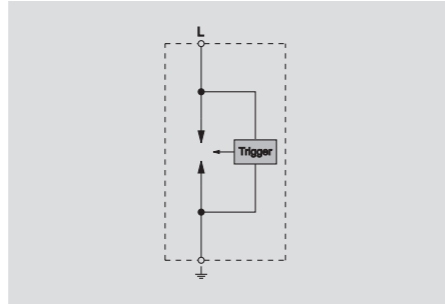
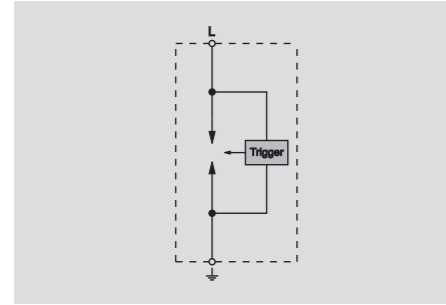

C



**Technical data**

**Technical data**  
 Rated voltage (AC)  
 max. continuous voltage, U<sub>c</sub> (AC)  
 Requirements class to IEC 61643-1  
 Lightning test voltage I imp (10/350 μs)  
 Specific energy, per path  
 Short-circuit current extinction without back-up fuse  
 Short-circuit strength with max. back-up fuse  
 Response time  
 Fuse, max.  
 Protection level Up (typical)  
 Optical function indicator  
 Ambient temperature (operational)  
 Storage temperature  
 Approvals

330 V  
 330 V  
 Class I  
 50 kA with 25 As charge  
 625 kJ/Ω  
 50 kA / 50 Hz  
 25 kA<sub>eff</sub>  
 ≤ 150 ns  
 250 A gL  
 900 V  
 green LED  
 -40 ... 85°C  
 -40 ... 85°C  
 cURus:File E198315;KEMA

440 V  
 440 V  
 Class I  
 50 kA with 25 As charge  
 625 kJ/Ω  
 50 kA / 50 Hz  
 25 kA<sub>eff</sub>  
 ≤ 150 ns  
 250 A gL  
 1500 V  
 green LED  
 -40 ... 85°C  
 -40 ... 85°C  
 cURus:File E198315;KEMA

**Dimensions**

Clamping range (rating- / min. / max.) mm²  
 Length x width x height mm

35 / 10 / 35  
 150 x 35 x 80

35 / 10 / 35  
 150 x 35 x 80

**Note**

**Ordering data**

**Version**  
 without telecomm. contact

Type	Qty.	Order No.
PU1 TSG Plus 330 VAC 0,9kV	1	8561220000

Type	Qty.	Order No.
PU1 TSG Plus 440 VAC 1,5kV	1	8561250000

**Note**

QB 36-3 cross-connection, order no. 8816090000  
 QB 36-4 cross-connection, order no. 8816100000

QB 36-3 cross-connection, order no. 8816090000  
 QB 36-4 cross-connection, order no. 8816100000

**Accessories**

**Note**

Designation BZ18, L1 L2 L3 N PE, order No. 8619460000

Designation BZ18, L1 L2 L3 N PE, order No. 8619460000

Surge protection for  
low-voltage supplies

C





**Combination arrester**

# Combination arrester

**Combination arrester  
Combined lightning and surge protection for  
low-voltage consumer installations and electronics**

The PU I+II COMBI combined surge protection incorporates triggered PU 1 TSG class I sparkover gaps, class II varistor arresters PU II and cross-connections. This setup protects low-voltage consumer installations and electronic devices against surge protection, both those caused by atmospheric discharges (lightning) and those caused by switching operations (transients). The PU COMBI complies with the requirements of IEC 61643-1 (Feb 1998). The PU R COMBI also has a remote signalling function achieved via a floating contact.

**Electrical connection**

The PU COMBI surge protection device is connected with lines as short as possible between the phase conductors (L1, L2, L3), or the neutral conductor (N), and the earth of the consumer installation. Unprotected lines (e.g. to meters) and protected lines must not be routed together.

The PU COMBI can be supplied for a 4-conductor system with three phases plus PEN conductor, and also for a 5-conductor system with three phases plus N-PE arrester.

**Checking operation, maintenance and approvals**

A visual check is necessary to ensure that the PU COMBI surge protection components are operating correctly. This visual check is easy because the arrester is fitted with a thermal disconnecter. If this has been tripped and protection is no longer provided, the flag in the status window changes from green to red. A tripped arrester is easily replaced by a qualified technician without having to disconnect any wiring. The top section of the varistor is coded according to voltage. Therefore, it is not possible to plug in a different, i.e. wrong, replacement varistor.

The cross-section of the earth line must be at least 10 mm<sup>2</sup> or half the cross-sectional area of the phase conductor. The fuse protection (max. 125 A gL) for the PU modules is chosen depending on the line cross-section and the type of wiring.

The connection is designed to IEC 947-7-1 for the following cross-sections:

solid wire:	10 ... 35 mm <sup>2</sup>
stranded wire:	10 ... 25 mm <sup>2</sup>
flexible:	10 ... 25 mm <sup>2</sup>

The operating temperature range is  
-40 °C ... +60 °C

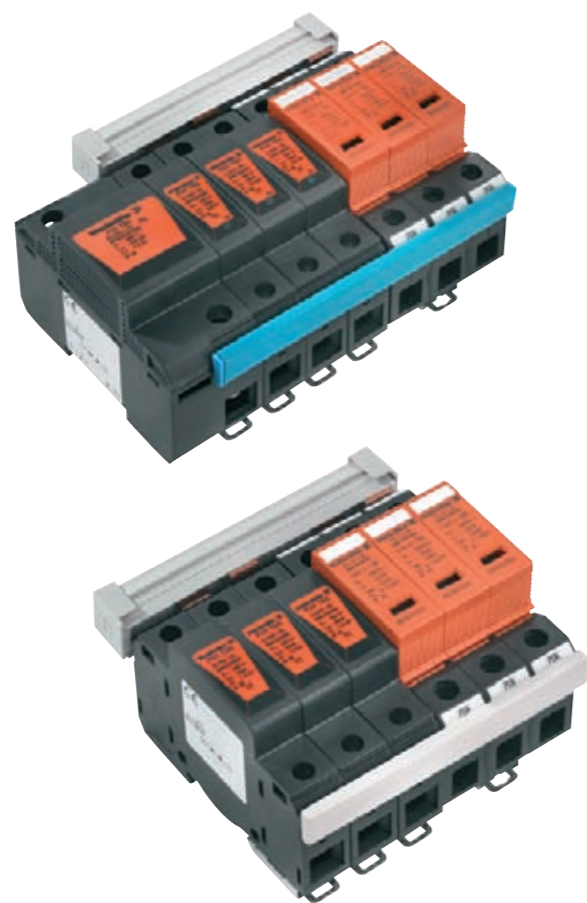

Combi-arrester connection diagram

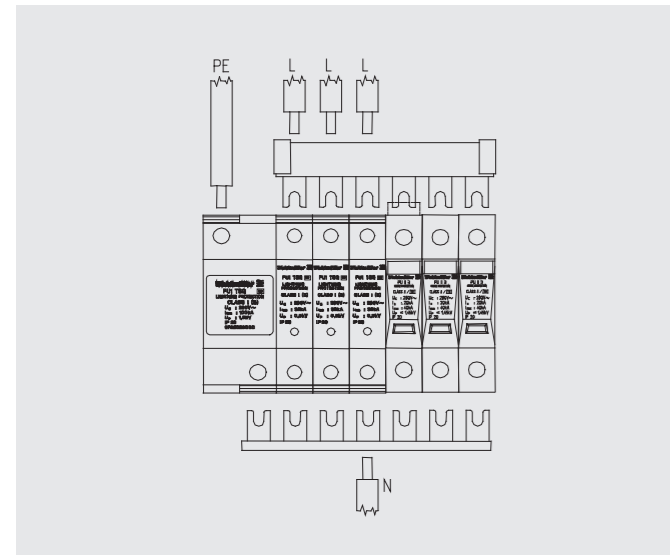
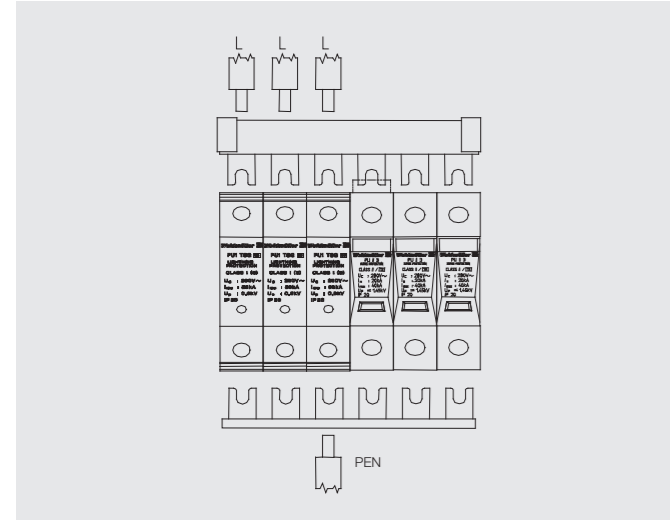

**Dimensions**

Type	length x width x height
PU Combi I+II 4-conductor system	90 x 65 x 110 mm
PU R Combi I+II 4-conductor system	90 x 65 x 110 mm
PU Combi I+II 5-conductor system	90 x 65 x 148 mm
PU R Combi I+II 5-conductor system	90 x 65 x 148 mm



## Combination arrester

### Combi-arrester for 4-wire systems

The surge protection combination consists of the class I triggered sparkover gap PU 1 TSG for protecting the phase to N of an N-PE sparkover gap and the class II PU 3 C. The arresters are interconnected via 16 mm<sup>2</sup> cross connection system.

The connection to the power line is made at the PU 1 TSG.

- Suitable for lightning protection classes I, II, III, IV.

### PU/R COMBI I+II 4 Wire

#### Use in building systems

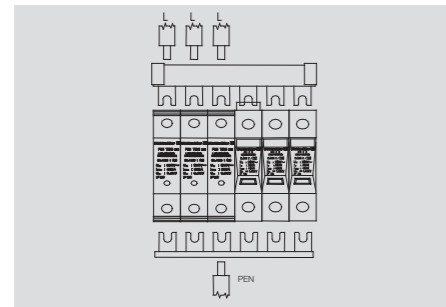

### Technical data

Technical data	
Rated voltage (AC)	230 V
max. continuous voltage, Uc (AC)	280 V
Requirements class to IEC 61643-1	I+II (combination arrester)
Lightning test voltage I imp (10/350 µs)	35 kA with 17.5 As charge
Specific energy, per path	64 kJ/Ω
Short-circuit current extinction without back-up fuse	3 kA / 50 Hz
Short-circuit strength with max. back-up fuse	25 kA <sub>eff</sub>
Response time	sym/ asym: ≤ 100 ns
Fuse, max.	125 A gL
Protection level Up (typical)	900 V
Optical function indicator	green = OK; red = arrester faulty, replace
Signalling contact	250 V 1A 1CO bei PU R COMBI
Ambient temperature (operational)	-40 ... 60°C
Storage temperature	-40 ... 80°C
Approvals	CE

Dimensions		without telecomm. contact		with telecomm. contact	
Clamping range (rating- / min. / max.)	mm <sup>2</sup>	35 / 6 / 10	35 / 6 / 10		
Length x width x height	mm	91 x 110 x 65	90 x 110 x 65		

Note

### Ordering data

Version	Type	Qty.	Order No.
without telecomm. contact	PU COMBI I+II 4 Wire	1	8729960000
with telecomm. contact	PU R COMBI I+II 4 Wire	1	8729970000

Note

### Accessories

Note
Set: PU II 3 (F), PU 1 TSG, bridges (jumpers)

**Combi-arrester for 5-wire systems**

The surge protection combination consists of the class I triggered sparkover gap PU 1 TSG for protecting the phase to N of an N-PE sparkover gap and the class II PU 3 C. The arresters are interconnected via 16 mm<sup>2</sup> cross connection system.

The connection to the power line is made at the PU 1 TSG.

- Suitable for lightning protection classes I, II, III, IV.

**PU/R COMBI I+II 5 Wire**

**Use in building systems**

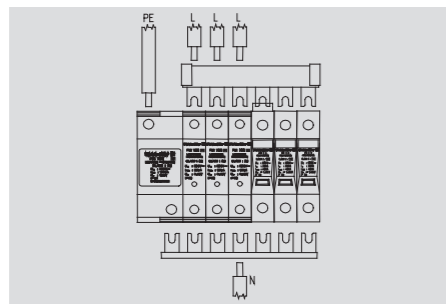

**Technical data**

Technical data	
Rated voltage (AC)	230 V
max. continuous voltage, Uc (AC)	280 V
Requirements class to IEC 61643-1	I+II (combination arrester)
Lightning test voltage I imp (10/350 μs)	35 kA with 17.5 As charge
	50 kA with 25 As charge
Specific energy, per path	64 kJ/Ω
Short-circuit current extinction without back-up fuse	3 kA
Short-circuit strength with max. back-up fuse	25 kA <sub>eff</sub>
Response time	sym/ asym: ≤ 100 ns
Fuse, max.	125 A gL
Protection level Up (typical)	1500 V
Optical function indicator	green = OK; red = arrester faulty, replace
Signalling contact	250 V 1A 1CO at PU R COMBI
Ambient temperature (operational)	-40 ... 60°C
Storage temperature	-40 ... 80°C
Approvals	CE

Dimensions	without telecomm. contact	with telecomm. contact
Clamping range (rating- / min. / max.)	35 / 6 / 10	35 / 6 / 10
Length x width x height	90 x 148 x 65	91 x 148 x 65

Note

**Ordering data**

Version	Type	Qty.	Order No.
without telecomm. contact	PU COMBI I+II 5 Wire	1	8729950000
with telecomm. contact	PU R COMBI I+II 5 Wire	1	8729930000

Note

**Accessories**

Note
Set: PU II 3 (F), PU 1 TSG, bridges (jumpers)



# Surge protection for low-voltage consumer installations and electronics

## Surge protection of class II

The Weidmüller PU II series surge protection protects low-voltage consumer installations and electronic devices against voltage surges that arise through, for example, atmospheric discharge (lightning) or switching activities (transients).

The PU II series satisfies the requirements of class II to IEC 61643-1:2008; type 2 to EN 61643-11 and class C to DIN VDE0675 pt 6 (Nov 1989) A1 (Feb 1996)/A2 (Oct 1996)

## Electrical connection

Connect the PU II surge protection between the phase conductors (L1, L2, L3) or, as the case may be, the neutral conductor (N) and earth of the consumer installation. The connecting conductors should be kept as short as possible. The fact that the protective unit can rotate 180° is helpful for this case.



Ensure that unprotected conductors (e.g. wires to the meter) are not run parallel to protected wires.

The universal “3+1” circuit for TN or TT systems is available from the Weidmüller product range.

The PU II surge protection device is available as a 2, 3 or 4-pole compact module, the PE connections of the discs being already internally connected to each other.

We can supply the following voltage rating versions:

$U_n$ : 60 V AC =  $U_c$ : 75 V

$U_n$ : 115/230 V AC =  $U_c$ : 130 V

$U_n$ : 230/400 V AC =  $U_c$ : 280 V

$U_n$ : 400/690 V AC =  $U_c$ : 385 V

$U_n$ : 470/600 V AC =  $U_c$ : 550 V

as well as for the 3+1 circuit and special types for IT networks.

The PU II series offers a choice of voltage ( $U_n < U_c$ ) and number of arresters to satisfy the various power systems. The national regulations and safety information must be observed, see IEC60364-5-53 or DIN VDE 0100 pt 534.

## Functional checks, maintenance and approvals

PU II surge modules can be checked visually by the user. The visual check is simple to perform because the arrester is provided with a thermal disconnecter. If this has responded, i.e. is no longer providing protection, the flag in the status window changes from green to red.



A non-functioning arrester can be replaced by a qualified technician without having to disconnect any wiring. The plug-in top sections of varistors are coded according to voltage. This means it is not possible to plug in the wrong replacement varistor.

## EWS system

The EWS system has a yellow indicator in the sight window in addition to the green and red indicators. This is a wear indicator that shows if the varistor has aged as a result of energy loads. This is also indicated via the optional telecommunication contact. Replacement of the plug-in arrester is recommended.

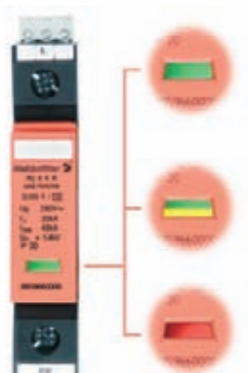

**LCF function**

The leakage current free protection circuit (LCF function) is achieved by connecting the varistor and sparkover gap in series. This protection circuit is needed in the case of an insulation monitoring device, for example.

**Connection**

The cross-section of the earthing conductor must be at least 10 mm<sup>2</sup> or half the cross-section of the phase conductors. The fuse for PU II modules is selected on the basis of conductor cross-section and type of routing. A maximum of 125 A gG/gL is permitted.

PU II series arresters from Weidmüller are suitable for the following cross-sections:  
 solid conductor: 4 ... 35 mm<sup>2</sup>  
 stranded conductor: 4... 25 mm<sup>2</sup>  
 flexible conductor: 4 ... 25 mm<sup>2</sup>  
 The operating temperature range is -40 °C ... +80 °C.

**RCD**

When installing the PU II series in the direction of power flow after a residual-current circuit-breaker (RCD), the surge current withstand strength must be taken into account. Before making an insulation resistance measurement at the facility, the pluggable arrester should be removed. It should then be re-inserted after the measurement has been taken.

**V-form connection**

When using cross-connections from the RCD or fuses to the PU II, a V-form wiring arrangement can be used.

**Remote signalling contact (R)**

All modules from the PU II series are optionally available with a remote signalling contact. It is then directly integrated into the module. This potential-free contact should be connected as a change-over contact via a screw / plug-in connection. The electrical data of the contact are: 250 V AC/1 A or 24 V DC/0.1 A.

**Coordination with other arresters**

The PU II series can be installed with the following Weidmüller surge protection devices without decoupling.

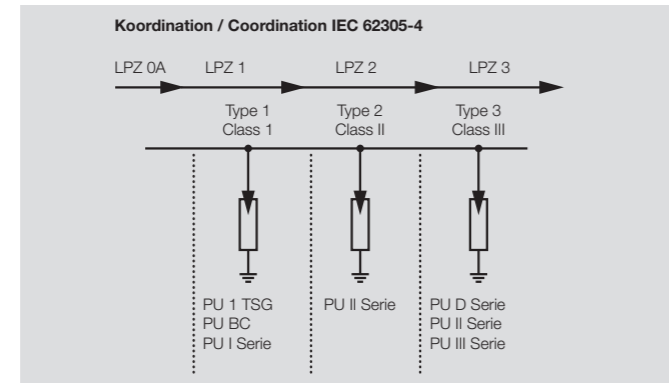

**Dimensional drawing PU-II series**

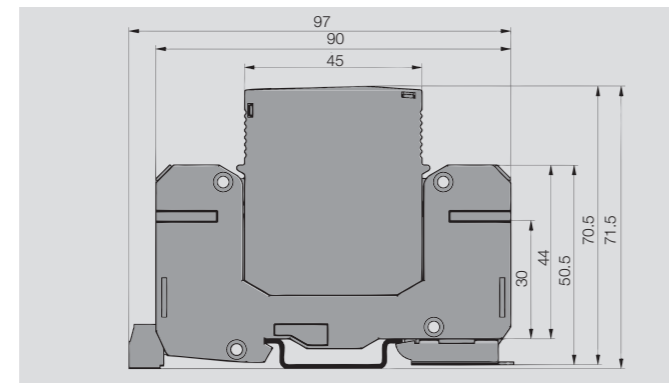

**Overall width**

- PU II, single-pole 18 mm
- PU II, two-pole 36 mm
- PU II, three-pole 54 mm
- PU II, four-pole 72 mm

**Accessories**

Type		grey	blue
	QB 18-4 insulated	8877520000	8877510000
	QB 18-3 insulated	8877500000	8877530000
	QB 18-2 insulated	8877540000	8877550000

**Class II with varistors**

**Class II with varistors**

- Surge protection of class II with Uc: 280 V
- plug-in varistor top section
  - coded voltage level, var. voltags.
  - high energy absorption with short response time
  - 180° rotatable insert
  - no follow current
  - installation in Insta distributor
  - thermal safety function
  - coordination between class I with Up: < 900 V

**PU II 4/R 280 V / 40 kA**

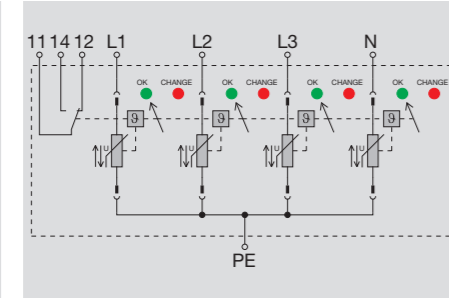

**PU II 3/R 280 V / 40 kA**

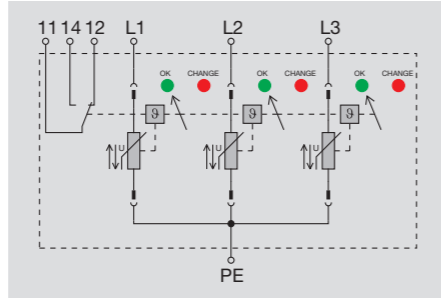

**Technical data**

<b>Technical data</b>	
Nominal voltage	230 V / 400 V
max. continuous voltage, Uc (AC)	280 V
max. continuous voltage, Uc (DC)	350 V
Requirements class to IEC 61643-1	Class II *
Rated discharge current (8/20 µs)	20 kA
Limiting discharge current (8/20 µs)	40 kA
Discharge current, max. (8/20 µs)	150 kA
Response time	≤ 25 ns
Fuse, max.	125 A gL
Protection level at In (Up)	< 1450 V
Protection level at 5 kA (Up)	< 850 V
Temporary surge - U <sub>TDV</sub>	335 V
Optical function indicator	green = OK; red = arrester faulty, replace
Signalling contact	250 V 1A 1CO at PU II 4 R
Design	4 unit widths; installation housing
Ambient temperature (operational)	-40 ... 80°C
Storage temperature	-40 ... 85°C
Approvals	CE, ÖVE, cURus in preparation

<b>without telecomm. contact with telecomm. contact</b>	
Clamping range (rating- / min. / max.)	25 / 4 / 25
Length x width x height	90 x 72 x 64
* This product also fulfils the requirements for Class III with Uoc: 6 kV	

<b>without telecomm. contact with telecomm. contact</b>	
Clamping range (rating- / min. / max.)	25 / 4 / 25
Length x width x height	90 x 54 x 64
* This product also fulfils the requirements for Class III with Uoc: 6 kV	

**Dimensions**

Clamping range (rating- / min. / max.)	mm²	25 / 4 / 25
Length x width x height	mm	90 x 72 x 64

<b>without telecomm. contact with telecomm. contact</b>		
Clamping range (rating- / min. / max.)	mm²	25 / 4 / 25
Length x width x height	mm	90 x 72 x 64

<b>without telecomm. contact with telecomm. contact</b>		
Clamping range (rating- / min. / max.)	mm²	25 / 4 / 25
Length x width x height	mm	90 x 54 x 64

**Note**

\* This product also fulfils the requirements for Class III with Uoc: 6 kV

\* This product also fulfils the requirements for Class III with Uoc: 6 kV

**Ordering data**

Version	Type	Qty.	Order No.
without telecomm. contact	PU II 4 280V/40kA	1	8859640000
	PU II 4 R 280V/40kA	1	8859660000

Type	Qty.	Order No.
PU II 4 280V/40kA	1	8859640000
PU II 4 R 280V/40kA	1	8859660000

Version	Type	Qty.	Order No.
without telecomm. contact	PU II 3 280V/40kA	1	8859630000
	PU II 3 R 280V/40kA	1	8859650000

--	--	--	--

--	--	--	--

**Note**

**Accessories**

**Note**

Plug-in spare arrester PU II 0 280V / 40kA - 8859750000

Plug-in spare arrester PU II 0 280V / 40kA - 8859750000



**Class II with varistors**

- Surge protection of class II with Uc: 280 V
- plug-in varistor top section
  - coded voltage level, var. volts.
  - high energy absorption with short response time
  - 180° rotatable insert
  - no follow current
  - installation in Insta distributor
  - thermal safety function
  - coordination between class I with Up: < 900 V

**PU II 2/R 280 V / 40 kA**

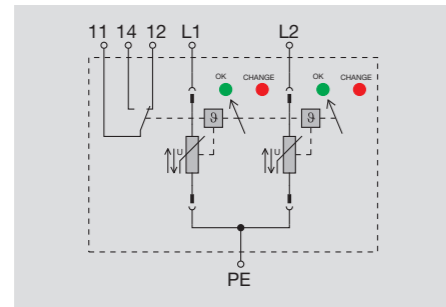

**PU II 1/R 280 V / 40 kA**

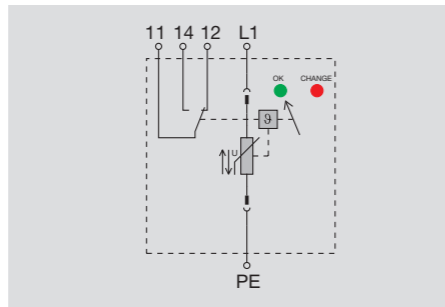

Surge protection for low-voltage supplies

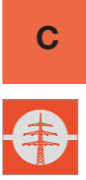

**Technical data**

<b>Technical data</b>	
Nominal voltage	230 V
max. continuous voltage, Uc (AC)	280 V
max. continuous voltage, Uc (DC)	350 V
Requirements class to IEC 61643-1	Class II *
Rated discharge current (8/20 µs)	20 kA
Limiting discharge current (8/20 µs)	40 kA
Discharge current, max. (8/20 µs)	75 kA
Response time	≤ 25 ns
Fuse, max.	125 A gL
Protection level at In (Up)	< 1450 V
Protection level at 5 kA (Up)	< 850 V
Temporary surge - U <sub>TDV</sub>	335 V
Optical function indicator	green = OK; red = arrester faulty, replace
Signalling contact	250 V 1A 1CO at PU II 2 R
Design	2 unit widths; installation housing
Ambient temperature (operational)	-40 ... 80°C
Storage temperature	-40 ... 85°C
Approvals	CE, ÖVE, cURus in preparation

<b>without telecomm. contact</b>	
<b>with telecomm. contact</b>	
25 / 4 / 25	25 / 4 / 25
90 x 36 x 64	97 x 36 x 64
* This product also fulfils the requirements for Class III with Uoc: 6 kV	

<b>without telecomm. contact</b>	
<b>with telecomm. contact</b>	
25 / 4 / 25	25 / 4 / 25
90 x 18 x 64	97 x 18 x 64
* This product also fulfils the requirements for Class III with Uoc: 6 kV	

**Dimensions**

Clamping range (rating- / min. / max.)	mm²
Length x width x height	mm

<b>without telecomm. contact</b>	
<b>with telecomm. contact</b>	
25 / 4 / 25	25 / 4 / 25
90 x 36 x 64	97 x 36 x 64

<b>without telecomm. contact</b>	
<b>with telecomm. contact</b>	
25 / 4 / 25	25 / 4 / 25
90 x 18 x 64	97 x 18 x 64

**Note**

\* This product also fulfils the requirements for Class III with Uoc: 6 kV

\* This product also fulfils the requirements for Class III with Uoc: 6 kV

**Ordering data**

<b>Version</b>	
without telecomm. contact	
with telecomm. contact	

<b>Type</b>	<b>Qty.</b>	<b>Order No.</b>
PU II 2 280V/40kA	1	8859680000
PU II 2 R 280V/40kA	1	8859670000

<b>Type</b>	<b>Qty.</b>	<b>Order No.</b>
PU II 1 280V/40kA	1	8859690000
PU II 1 R 280V/40kA	1	8859700000

**Note**

**Accessories**

**Note**

Plug-in spare arrester PU II 0 280V / 40kA - 8859750000

Plug-in spare arrester PU II 0 280V / 40kA - 8859750000

**Class II with varistors**

**Class II with varistors**

- Surge protection of class II with Uc: 280 V
- 3+1 surge protection, suitable for TN and TT systems
  - plug-in varistor top part
  - coded voltage level
  - high energy absorption with short response time
  - 180° rotatable insert
  - no follow current
  - installation in Insta distributor
  - thermal safety function
  - coordination between class I with Up: < 900 V

**PU II 3+1/R 280 V / 40 kA**

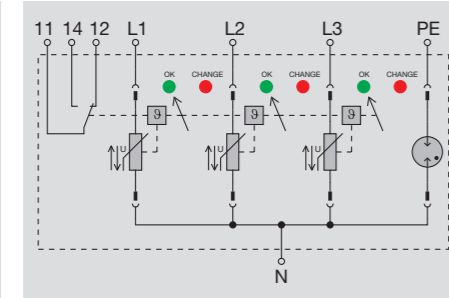

**PU II 1+1/R 280 V / 40 kA**

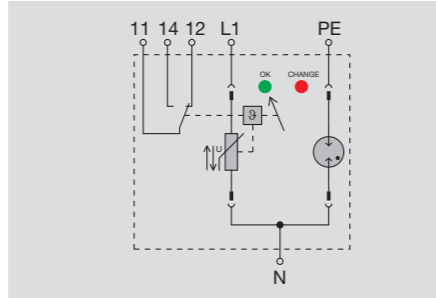

**Technical data**

Technical data	
Nominal voltage	230 V / 400 V
max. continuous voltage, Uc (AC)	280 V
max. continuous voltage, Uc (DC)	350 V
Requirements class to IEC 61643-1	Class II *
Rated discharge current (8/20 μs)	20 kA
Limiting discharge current (8/20 μs)	40 kA
Discharge current, max. (8/20 μs)	150 kA
Response time	≤ 25 ns
Fuse, max.	125 A gL
Maximum continuous voltage, Uc (N-PE)	260 V
Limiting leakage current per path 8/20 μs (N-PE)	40 kA
Protection level for In (N-PE)	< 1350 V
Protection level at In (Up)	< 1450 V
Protection level at 5 kA (Up)	< 850 V
Temporary surge - U <sub>TOV</sub>	335 V
Optical function indicator	green = OK; red = arrester faulty, replace
Signalling contact	250 V 1A 1CO at PU II 3+1 R
Design	4 unit widths; installation housing
Ambient temperature (operational)	-40 ... 80°C
Storage temperature	-40 ... 85°C
Approvals	CE, ÖVE, cURus in preparation

without telecomm. contact with telecomm. contact	
230 V / 400 V	230 V
280 V	280 V
350 V	350 V
Class II *	Class II *
20 kA	20 kA
40 kA	40 kA
150 kA	75 kA
≤ 25 ns	≤ 25 ns
125 A gL	125 A gL
260 V	260 V
40 kA	40 kA
< 1350 V	< 1350 V
< 1450 V	< 1450 V
< 850 V	< 850 V
335 V	335 V
green = OK; red = arrester faulty, replace	green = OK; red = arrester faulty, replace
250 V 1A 1CO at PU II 3+1 R	250 V 1A 1CO at PU II 1+1 R
4 unit widths; installation housing	2 unit widths; installation housing
-40 ... 80°C	-40 ... 80°C
-40 ... 85°C	-40 ... 85°C
CE, ÖVE, cURus in preparation	CE, ÖVE, cURus in preparation

without telecomm. contact with telecomm. contact	
230 V	230 V
280 V	280 V
350 V	350 V
Class II *	Class II *
20 kA	20 kA
40 kA	40 kA
75 kA	75 kA
≤ 25 ns	≤ 25 ns
125 A gL	125 A gL
260 V	260 V
40 kA	40 kA
< 1350 V	< 1350 V
< 1450 V	< 1450 V
< 850 V	< 850 V
335 V	335 V
green = OK; red = arrester faulty, replace	green = OK; red = arrester faulty, replace
250 V 1A 1CO at PU II 3+1 R	250 V 1A 1CO at PU II 1+1 R
2 unit widths; installation housing	2 unit widths; installation housing
-40 ... 80°C	-40 ... 80°C
-40 ... 85°C	-40 ... 85°C
CE, ÖVE, cURus in preparation	CE, ÖVE, cURus in preparation

**Dimensions**

Clamping range (rating- / min. / max.)	mm²	25 / 4 / 25
Length x width x height	mm	90 x 72 x 64

without telecomm. contact with telecomm. contact	
25 / 4 / 25	25 / 4 / 25
90 x 72 x 64	97 x 72 x 64

without telecomm. contact with telecomm. contact	
25 / 4 / 25	25 / 4 / 25
90 x 36 x 64	97 x 36 x 64

**Note**

\* This product also fulfils the requirements for Class III with Uoc: 6 kV

\* This product also fulfils the requirements for Class III with Uoc: 6 kV

**Ordering data**

Version	Type	Qty.	Order No.
without telecomm. contact	PU II 3+1 280V/40kA	1	8859710000
with telecomm. contact	PU II 3+1R 280V/40kA	1	8859720000

Type	Qty.	Order No.
PU II 3+1 280V/40kA	1	8859710000
PU II 3+1R 280V/40kA	1	8859720000

Type	Qty.	Order No.
PU II 1+1 280V/40kA	1	8859730000
PU II 1+1R 280V/40kA	1	8859740000

**Note**

**Accessories**

<b>Note</b>	Plug-in spare arrester PU II 0 280V / 40kA - 8859750000
	Plug-in spare arrester PU II 0 N-PE 280V / 40kA - 8871940000

Plug-in spare arrester PU II 0 280V / 40kA - 8859750000
Plug-in spare arrester PU II 0 N-PE 280V / 40kA - 8871940000

Plug-in spare arrester PU II 0 280V / 40kA - 8859750000
Plug-in spare arrester PU II 0 N-PE 280V / 40kA - 8871940000

**Class II with varistors**

- Surge protection of class II with  $U_c$ : 280 V
- plug-in varistor top section
  - coded voltage level, var. voltgs.
  - high energy absorption with short response time
  - 180° rotatable insert
  - no follow current
  - installation in Insta distributor
  - thermal safety function
  - coordination between class I with  $U_p$ : < 900 V
  - leakage current free design for installation before meter

**PU II 4 LCF/R LCF 280 V / 40 kA**

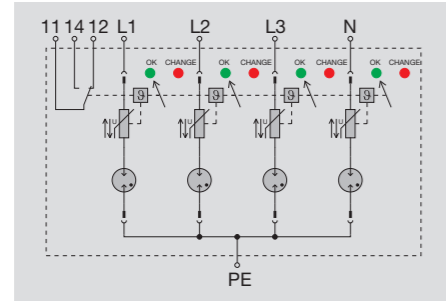

**PU II 3 LCF/R LCF 280 V / 40 kA**

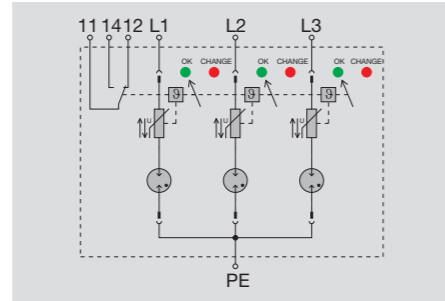

Surge protection for low-voltage supplies

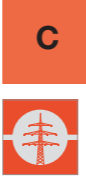

**Technical data**

Technical data	
Nominal voltage	230 V / 400 V
max. continuous voltage, $U_c$ (AC)	280 V
max. continuous voltage, $U_c$ (DC)	350 V
Requirements class to IEC 61643-1	Class II *
Rated discharge current (8/20 $\mu$ s)	20 kA
Limiting discharge current (8/20 $\mu$ s)	20 kA
Discharge current, max. (8/20 $\mu$ s)	80 kA
Response time	$\leq 25$ ns
Fuse, max.	125 A gL
Protection level at $I_n$ ( $U_p$ )	< 2500 V
Protection level at 5 kA ( $U_p$ )	< 850 V
Temporary surge - $U_{TDOV}$	335 V
Optical function indicator	green = OK; red = arrester faulty, replace
Signalling contact	250 V 1A 1CO at PU II 4 R
Design	4 unit widths; installation housing
Ambient temperature (operational)	-40 ... 80°C
Storage temperature	-40 ... 85°C
Approvals	CE, ÖVE, cURus in preparation

without telecomm. contact		with telecomm. contact	
25 / 4 / 25	25 / 4 / 25	90 x 72 x 64	97 x 72 x 64
* This product also fulfils the requirements for Class III with $U_{oc}$ : 6 kV			

without telecomm. contact		with telecomm. contact	
25 / 4 / 25	25 / 4 / 25	90 x 54 x 64	97 x 54 x 64
* This product also fulfils the requirements for Class III with $U_{oc}$ : 6 kV			

**Dimensions**

Clamping range (rating- / min. / max.)	mm <sup>2</sup>
Length x width x height	mm

25 / 4 / 25	25 / 4 / 25	90 x 72 x 64	97 x 72 x 64
-------------	-------------	--------------	--------------

25 / 4 / 25	25 / 4 / 25	90 x 54 x 64	97 x 54 x 64
-------------	-------------	--------------	--------------

**Note**

\* This product also fulfils the requirements for Class III with  $U_{oc}$ : 6 kV

\* This product also fulfils the requirements for Class III with  $U_{oc}$ : 6 kV

**Ordering data**

Version	Type	Qty.	Order No.
without telecomm. contact	PU II 4 LCF 280V/20kA	1	8859770000
with telecomm. contact	PU II 4 R LCF 280V/20kA	1	8859790000

Type	Qty.	Order No.
PU II 4 LCF 280V/20kA	1	8859770000
PU II 4 R LCF 280V/20kA	1	8859790000

Type	Qty.	Order No.
PU II 3 LCF 280V/20kA	1	8859760000
PU II 3 R LCF 280V/20kA	1	8859780000

**Note**

Plug-in spare arrester PU II 0 LCF 280V/40kA - 888934000

Plug-in spare arrester PU II 0 LCF 280V/40kA - 888934000

**Accessories**

**Note**

Plug-in spare arrester PU II 0 LCF 280V/40kA - 888934000

Plug-in spare arrester PU II 0 LCF 280V/40kA - 888934000

**Class II with varistors**

**Class II with varistors**

- Surge protection of class II with Uc: 280 V
- failure warning through yellow LED
- plug-in varistor top section
- coded voltage level
- high energy absorption with short response time
- 180° rotatable insert
- no follow current
- installation in Insta distributor
- thermal safety function
- coordination between class I with Up: < 900 V

**PU II 4 EWS/R EWS 280 V / 40 kA**

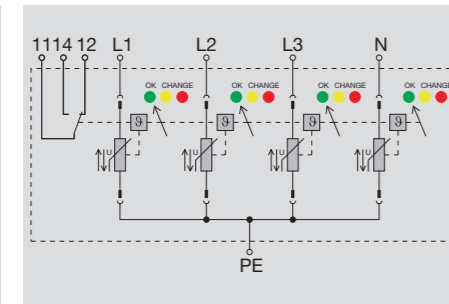

**PU II 3 EWS/R EWS 280 V / 40 kA**

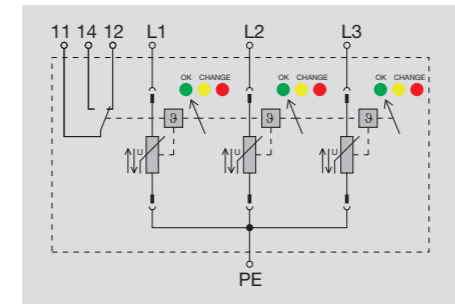

**Technical data**

Technical data	PU II 4 EWS/R EWS 280 V / 40 kA	PU II 3 EWS/R EWS 280 V / 40 kA
Nominal voltage	230 V / 400 V	230 V / 400 V
max. continuous voltage, Uc (AC)	280 V	280 V
max. continuous voltage, Uc (DC)	350 V	350 V
Requirements class to IEC 61643-1	Class II *	Class II *
Rated discharge current (8/20 μs)	20 kA	20 kA
Limiting discharge current (8/20 μs)	40 kA	40 kA
Discharge current, max. (8/20 μs)	150 kA	110 kA
Response time	≤ 25 ns	≤ 25 ns
Fuse, max.	125 A gL	125 A gL
Protection level at In (Up)	< 1450 V	< 1450 V
Protection level at 5 kA (Up)	< 850 V	< 850 V
Temporary surge - U <sub>TDV</sub>	335 V	335 V
Optical function indicator	green = ok, yellow = warning, red = arrester faulty, replace	green = ok, yellow = warning, red = arrester faulty, replace
Signalling contact	250 V 1A 1CO at PU II 4 R	250 V 1A 1CO at PU II 3 R
Design	4 unit widths; installation housing	3 unit widths; installation housing
Ambient temperature (operational)	-40 ... 80°C	-40 ... 80°C
Storage temperature	-40 ... 85°C	-40 ... 85°C
Approvals	CE, ÖVE, cURus in preparation	CE, ÖVE, cURus in preparation

Dimensions	without telecomm. contact	with telecomm. contact	without telecomm. contact	with telecomm. contact
Clamping range (rating- / min. / max.)	25 / 4 / 25	25 / 4 / 25	25 / 4 / 25	25 / 4 / 25
Length x width x height	90 x 72 x 64	97 x 72 x 64	90 x 54 x 64	97 x 54 x 64
<b>Note</b>	* This product also fulfils the requirements for Class III with Uoc: 6 kV		* This product also fulfils the requirements for Class III with Uoc: 6 kV	

**Ordering data**

Version	Type	Qty.	Order No.	Type	Qty.	Order No.
without telecomm. contact	PU II 4 EWS 280V/40kA	1	<b>8859810000</b>	PU II 3 EWS 280V/40kA	1	<b>8859800000</b>
with telecomm. contact	PU II 4 R EWS 280V/40kA	1	<b>8859830000</b>	PU II 3 R EWS 280V/40kA	1	<b>8859820000</b>
<b>Note</b>						

**Accessories**

<b>Note</b>	Plug-in spare arrester PU II 0 EWS 280V/40kA - 8889350000	Plug-in spare arrester PU II 0 EWS 280V/40kA - 8889350000
-------------	---	---

Surge protection for  
low-voltage supplies

C



**Class II with varistors**

**Class II with varistors**

- Surge protection of class II with Uc: 385 V
- plug-in varistor top section
  - coded voltage level, var. voltds.
  - high energy absorption with short response time
  - 180° rotatable insert
  - no follow current
  - installation in Insta distributor
  - thermal safety function

**PU II 4/R 385 V / 40 kA**

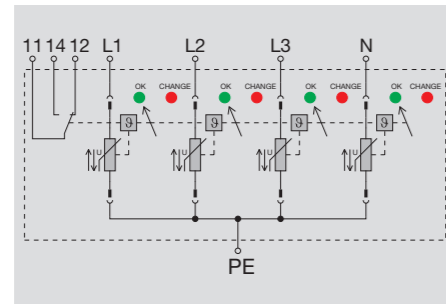

**PU II 3/R 385 V / 40 kA**

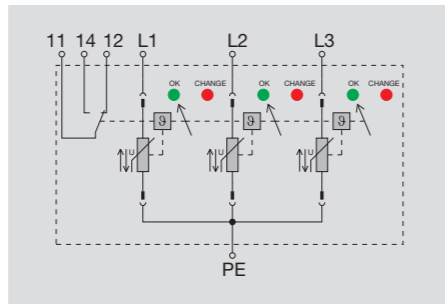

**Technical data**

Technical data	
Nominal voltage	385 V / 660 V
max. continuous voltage, Uc (AC)	385 V
max. continuous voltage, Uc (DC)	500 V
Requirements class to IEC 61643-1	Class II *
Rated discharge current (8/20 μs)	20 kA
Limiting discharge current (8/20 μs)	40 kA
Discharge current, max. (8/20 μs)	150 kA
Response time	≤ 25 ns
Fuse, max.	125 A gL
Protection level at In (Up)	< 1800 V
Protection level at 5 kA (Up)	< 1300 V
Temporary surge - U <sub>TDV</sub>	400 V
Optical function indicator	green = OK; red = arrester faulty, replace
Signalling contact	250 V 1A 1CO at PU II 4 R
Design	4 unit widths; installation housing
Ambient temperature (operational)	-40 ... 80°C
Storage temperature	-40 ... 85°C
Approvals	CE, ÖVE, cURus in preparation

385 V / 660 V
385 V
500 V
Class II *
20 kA
40 kA
150 kA
≤ 25 ns
125 A gL
< 1800 V
< 1300 V
400 V
green = OK; red = arrester faulty, replace
250 V 1A 1CO at PU II 4 R
4 unit widths; installation housing
-40 ... 80°C
-40 ... 85°C
CE, ÖVE, cURus in preparation

385 V / 660 V
385 V
500 V
Class II *
20 kA
40 kA
110 kA
≤ 25 ns
125 A gL
< 1800 V
< 1300 V
400 V
green = OK; red = arrester faulty, replace
250 V 1A 1CO at PU II 3 R
3 unit widths; installation housing
-40 ... 80°C
-40 ... 85°C
CE, ÖVE, cURus in preparation

**Dimensions**

Clamping range (rating- / min. / max.)	mm²
25 / 4 / 25	25 / 4 / 25
Length x width x height	mm
90 x 72 x 64	97 x 72 x 64

without telecomm. contact	with telecomm. contact
25 / 4 / 25	25 / 4 / 25
90 x 72 x 64	97 x 72 x 64

without telecomm. contact	with telecomm. contact
25 / 4 / 25	25 / 4 / 25
90 x 54 x 64	97 x 54 x 64

\* This product also fulfils the requirements for Class III with Uoc: 6 kV

\* This product also fulfils the requirements for Class III with Uoc: 6 kV

\* This product also fulfils the requirements for Class III with Uoc: 6 kV

**Ordering data**

Version	Type	Qty.	Order No.
without telecomm. contact	PU II 4 385V/40kA	1	8859860000
with telecomm. contact	PU II 4 R 385V/40kA	1	8859870000

Type	Qty.	Order No.
PU II 4 385V/40kA	1	8859860000
PU II 4 R 385V/40kA	1	8859870000

Type	Qty.	Order No.
PU II 3 385V/40kA	1	8859840000
PU II 3 R 385V/40kA	1	8859850000

**Note**

**Accessories**

Note
Plug-in spare arrester PU II 0 385V / 40kA - 8859940000

Plug-in spare arrester PU II 0 385V / 40kA - 8859940000

Plug-in spare arrester PU II 0 385V / 40kA - 8859940000

**Class II with varistors**

- Surge protection of class II with Uc: 385 V
- plug-in varistor top section
  - coded voltage level, var. volts.
  - high energy absorption with short response time
  - 180° rotatable insert
  - no follow current
  - installation in Insta distributor
  - thermal safety function

**PU II 2/R 385 V / 40 kA**

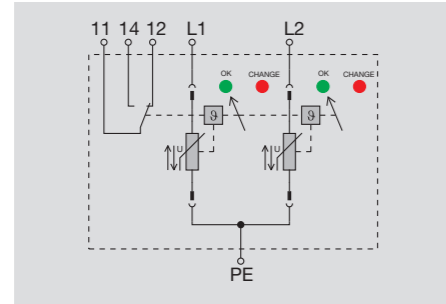

**PU II 1/R 385 V / 40 kA**

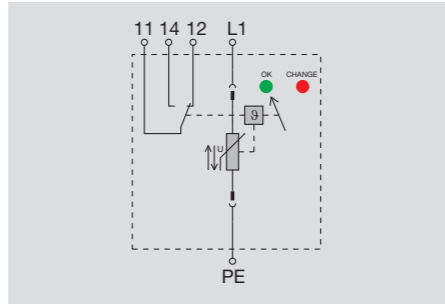

Surge protection for low-voltage supplies

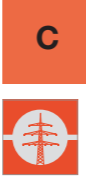

**Technical data**

<b>Technical data</b>	
Nominal voltage	385 V
max. continuous voltage, Uc (AC)	385 V
max. continuous voltage, Uc (DC)	500 V
Requirements class to IEC 61643-1	Class II *
Rated discharge current (8/20 µs)	20 kA
Limiting discharge current (8/20 µs)	40 kA
Discharge current, max. (8/20 µs)	75 kA
Response time	≤ 25 ns
Fuse, max.	125 A gL
Protection level at In (Up)	< 1800 V
Protection level at 5 kA (Up)	< 1300 V
Temporary surge - U <sub>TDV</sub>	400 V
Optical function indicator	green = OK; red = arrester faulty, replace
Signalling contact	250 V 1A 1CO at PU II 2 R
Design	2 unit widths; installation housing
Ambient temperature (operational)	-40 ... 80°C
Storage temperature	-40 ... 85°C
Approvals	CE, ÖVE, cURus in preparation

<b>without telecomm. contact with telecomm. contact</b>	
25 / 4 / 25	25 / 4 / 25
90 x 36 x 64	97 x 36 x 64
* This product also fulfils the requirements for Class III with Uoc: 6 kV	

<b>without telecomm. contact with telecomm. contact</b>	
25 / 4 / 25	25 / 4 / 25
90 x 18 x 64	97 x 18 x 64
* This product also fulfils the requirements for Class III with Uoc: 6 kV	

**Dimensions**

Clamping range (rating- / min. / max.)	mm²
Length x width x height	mm

**Note**

**Ordering data**

Version	Type	Qty.	Order No.
without telecomm. contact	PU II 2 385V/40kA	1	8859900000
with telecomm. contact	PU II 2R 385V/40kA	1	8859910000

**Note**

**Accessories**

**Note**

Plug-in spare arrester PU II 0 385V / 40kA - 8859940000

Plug-in spare arrester PU II 0 385V / 40kA - 8859940000



**Class II with varistors****Class II with varistors**

Surge protection of class II with Uc: 385 V

- plug-in varistor top section
- coded voltage level, var. voltds.
- high energy absorption with short response time
- 180° rotatable insert
- no follow current
- installation in Insta distributor
- thermal safety function

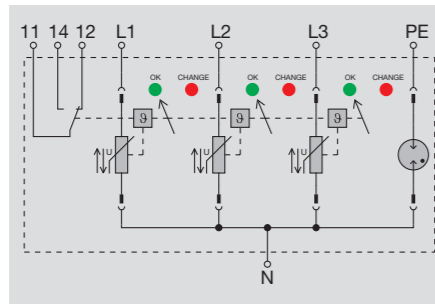
**PU II 3+1/R 385 V / 40 kA****Technical data**

Technical data	
Nominal voltage	385 V / 660 V
max. continuous voltage, Uc (AC)	385 V
max. continuous voltage, Uc (DC)	500 V
Requirements class to IEC 61643-1	Class II *
Rated discharge current (8/20 μs)	20 kA
Limiting discharge current (8/20 μs)	40 kA
Discharge current, max. (8/20 μs)	110 kA
Response time	≤ 25 ns
Fuse, max.	125 A gL
Protection level for In (N-PE)	< 1350 V
Protection level at In (Up)	< 1800 V
Protection level at 5 kA (Up)	< 1300 V
Temporary surge - U <sub>TOV</sub>	400 V
Optical function indicator	green = OK; red = arrester faulty, replace
Signalling contact	250 V 1A 1CO at PU II 3+1 R
Design	4 unit widths; installation housing
Ambient temperature (operational)	-40 ... 80°C
Storage temperature	-40 ... 85°C
Approvals	CE, ÖVE, cURus in preparation

**Dimensions**

Dimensions		without telecomm. contact	with telecomm. contact
Clamping range (rating- / min. / max.)	mm²	25 / 4 / 25	25 / 4 / 25
Length x width x height	mm	90 x 72 x 64	97 x 72 x 64

**Note** \* This product also fulfils the requirements for Class III with Uc: 6 kV

**Ordering data**

Version	Type	Qty.	Order No.
without telecomm. contact	PU II 3+1 385V/40kA	1	8859880000
with telecomm. contact	PU II 3+1R 385V/40kA	1	8859890000

**Note****Accessories**

Accessories	Note
	Plug-in spare arrester PU II O 385V / 40kA - 8859940000
	Plug-in spare arrester PU II O N-PE 280V / 40kA - 8871940000

Surge protection for  
low-voltage supplies

C



**Class II with varistors**

**Class II with varistors**

- Surge protection of class II with  $U_c$ : 130 V
- plug-in varistor top section
- coded voltage level, var. volts.
- high energy absorption with short response time
- 180° rotatable insert
- no follow current
- installation in Insta distributor
- thermal safety function

**PU II 4/R 130 V / 40 kA**

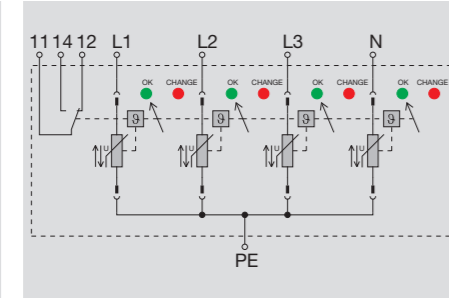

**PU II 3/R 130 V / 40 kA**

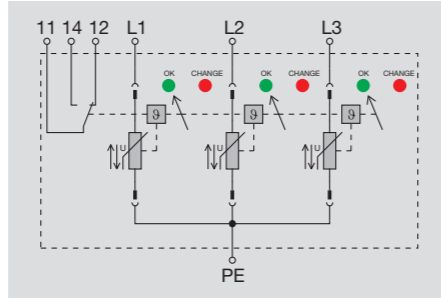

**Technical data**

Technical data	
Nominal voltage	120 V / 230 V
max. continuous voltage, $U_c$ (AC)	130 V
max. continuous voltage, $U_c$ (DC)	170 V
Requirements class to IEC 61643-1	Class II *
Rated discharge current (8/20 $\mu$ s)	20 kA
Limiting discharge current (8/20 $\mu$ s)	40 kA
Discharge current, max. (8/20 $\mu$ s)	150 kA
Response time	$\leq 25$ ns
Fuse, max.	125 A gL
Protection level at $I_n$ ( $U_p$ )	$< 850$ V
Protection level at 5 kA ( $U_p$ )	$< 500$ V
Temporary surge - $U_{TPOV}$	150 V
Optical function indicator	green = OK; red = arrester faulty, replace
Signalling contact	250 V 1A 1CO at PU II 4 R
Design	4 unit widths; installation housing
Ambient temperature (operational)	-40 ... 80°C
Storage temperature	-40 ... 85°C
Approvals	CE, ÖVE, cURus in preparation

without telecomm. contact		with telecomm. contact	
25 / 4 / 25	25 / 4 / 25	90 x 72 x 64	97 x 72 x 64
* This product also fulfils the requirements for Class III with $U_{oc}$ : 6 kV			

without telecomm. contact		with telecomm. contact	
25 / 4 / 25	25 / 4 / 25	90 x 54 x 64	97 x 54 x 64
* This product also fulfils the requirements for Class III with $U_{oc}$ : 6 kV			

**Dimensions**

Clamping range (rating- / min. / max.)	mm²	25 / 4 / 25
Length x width x height	mm	90 x 72 x 64

25 / 4 / 25	25 / 4 / 25
90 x 72 x 64	97 x 72 x 64

25 / 4 / 25	25 / 4 / 25
90 x 54 x 64	97 x 54 x 64

**Ordering data**

Version	Type	Qty.	Order No.
without telecomm. contact	PU II 4 130V/40kA	1	8860010000
with telecomm. contact	PU II 4 R 130V/40kA	1	8860020000

1	8860010000
1	8860020000

Version	Type	Qty.	Order No.
without telecomm. contact	PU II 3 130V/40kA	1	8859990000
with telecomm. contact	PU II 3 R 130V/40kA	1	8860000000

1	8859990000
1	8860000000

**Note**

**Accessories**

Note	Plug-in spare arrester PU II 0 130V / 40kA - 8860030000
------	---

Plug-in spare arrester PU II 0 130V / 40kA - 8860030000
---

Note	Plug-in spare arrester PU II 0 130V / 40kA - 8860030000
------	---

Plug-in spare arrester PU II 0 130V / 40kA - 8860030000
---

**Class II with varistors**

- Surge protection of class II with  $U_c$ : 130 V
- plug-in varistor top section
  - coded voltage level, var. volts.
  - high energy absorption with short response time
  - 180° rotatable insert
  - no follow current
  - installation in Insta distributor
  - thermal safety function

**PU II 2/R 130 V / 40 kA**



**PU II 1/R 130 V / 40 kA**

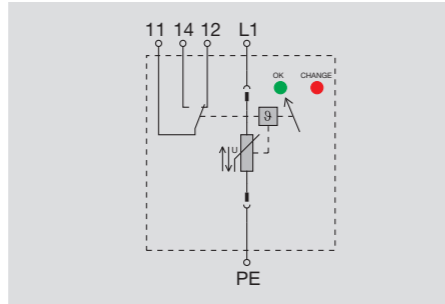
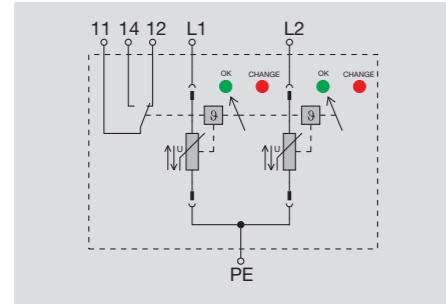

**Technical data**

<b>Technical data</b>	
Nominal voltage	120 V
max. continuous voltage, $U_c$ (AC)	130 V
max. continuous voltage, $U_c$ (DC)	170 V
Requirements class to IEC 61643-1	Class II *
Rated discharge current (8/20 $\mu$ s)	20 kA
Limiting discharge current (8/20 $\mu$ s)	40 kA
Discharge current, max. (8/20 $\mu$ s)	75 kA
Response time	$\leq 25$ ns
Fuse, max.	125 A gL
Protection level at $I_n$ ( $U_p$ )	$< 850$ V
Protection level at 5 kA ( $U_p$ )	$< 500$ V
Temporary surge - $U_{TDOV}$	150 V
Optical function indicator	green = OK; red = arrester faulty, replace
Signalling contact	250 V 1A 1CO at PU II 2 R
Design	2 unit widths; installation housing
Ambient temperature (operational)	-40 ... 80°C
Storage temperature	-40 ... 85°C
Approvals	CE, ÖVE, cURus in preparation

<b>without telecomm. contact</b>		<b>with telecomm. contact</b>	
Clamping range (rating- / min. / max.)	25 / 4 / 25	25 / 4 / 25	25 / 4 / 25
Length x width x height	90 x 36 x 64	97 x 36 x 64	90 x 18 x 64
* This product also fulfils the requirements for Class III with $U_{oc}$ : 6 kV			

**Dimensions**

Clamping range (rating- / min. / max.)	mm²	25 / 4 / 25
Length x width x height	mm	90 x 36 x 64

**Note**

**Ordering data**

Version	Type	Qty.	Order No.
without telecomm. contact with telecomm. contact	PU II 2 130V/40kA	1	8859970000
	PU II 2 R 130V/40kA	1	8859980000

**Note**

**Accessories**

**Note**

Plug-in spare arrester PU II 0 130V / 40kA - 8860030000

<b>without telecomm. contact</b>		<b>with telecomm. contact</b>	
Clamping range (rating- / min. / max.)	25 / 4 / 25	25 / 4 / 25	25 / 4 / 25
Length x width x height	90 x 18 x 64	97 x 18 x 64	90 x 18 x 64
* This product also fulfils the requirements for Class III with $U_{oc}$ : 6 kV			

**Dimensions**

Clamping range (rating- / min. / max.)	mm²	25 / 4 / 25
Length x width x height	mm	90 x 18 x 64

**Note**

**Ordering data**

Version	Type	Qty.	Order No.
without telecomm. contact with telecomm. contact	PU II 1 130V/40kA	1	8859950000
	PU II 1 R 130V/40kA	1	8859960000

**Note**

Plug-in spare arrester PU II 0 130V / 40kA - 8860030000

Surge protection for low-voltage supplies

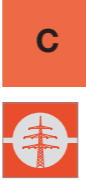

## Class II with varistors

### Class II with varistors

- Surge protection of class II with  $U_c$ : 550 V for photovoltaic applications
- plug-in varistor top section
  - Coded voltage levels, diverse voltage
  - high energy absorption with short time to sparkover
  - insert can be rotated through 180°
  - no follow current
  - installed in Insta distributor
  - thermal protection
  - coordination between class I with  $U_p$ : <1.5 kV

### PU II 2+1/R 550 V / 40 kA

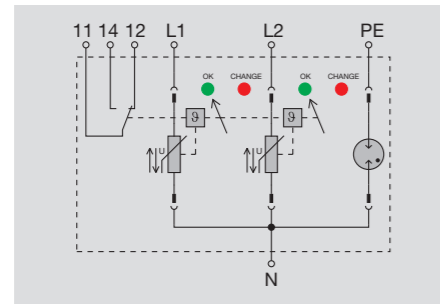

### PU II 2+1/R 1000 V / 40 kA

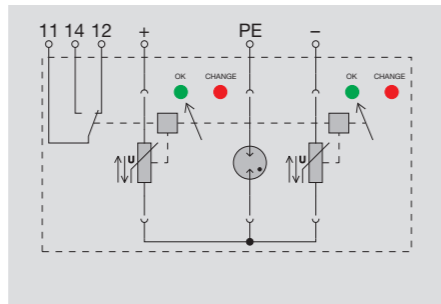

## Technical data

**Technical data**  
 PV voltage to IEC 60364-7-712  
 max. continuous voltage, DC [(L+/-) ->PE]  
 Nominal voltage  
 max. continuous voltage,  $U_c$  (AC)  
 max. continuous voltage,  $U_c$  (DC)  
 Requirements class to IEC 61643-1  
 Rated discharge current (8/20  $\mu$ s)  
 Limiting discharge current (8/20  $\mu$ s)  
 Discharge current, max. (8/20  $\mu$ s)  
 Response time  
 Fuse, max.  
 Protection level at  $I_n$  ( $U_p$ )  
 Protection level at 5 kA ( $U_p$ )  
 Temporary surge -  $U_{TOV}$   
 Optical function indicator  
 Signalling contact  
 Design  
 Ambient temperature (operational)  
 Storage temperature  
 Approvals

$\leq 1000$ V
900 V AC / 1200 V DC
550 V
550 V
745 V
Class II *
20 kA
40 kA
40 kA
$\leq 25$ ns
125 A gL
< 2650 V
< 1700 V
550 V
green = OK; red = arrester faulty, replace
250 V 1A 1CO at PU II 2+1 R
3 unit widths; installation housing
-40 ... 80°C
-40 ... 85°C
CE, ÖVE, cURus in preparation

$\leq 1000$ V
900 V AC / 1200 V DC
550 V
550 V
745 V
Class II *
20 kA
40 kA
40 kA
$\leq 25$ ns
125 A gL
< 2650 V
< 1700 V
550 V
green = OK; red = arrester faulty, replace
250 V 1A 1CO at PU II 2+1 R
3 unit widths; installation housing
-40 ... 80°C
-40 ... 85°C
CE, ÖVE, cURus in preparation

## Dimensions

Clamping range (rating- / min. / max.) mm<sup>2</sup>  
 Length x width x height mm

without telecomm. contact with telecomm. contact		
25 / 4 / 25	25 / 4 / 25	
90 x 54 x 58	99 x 54 x 58	

without telecomm. contact with telecomm. contact		
25 / 4 / 25	25 / 4 / 25	
90 x 54 x 58	99 x 54 x 58	

\* This product also fulfils the requirements for Class III with  $U_{oc}$ : 6 kV

\* This product also fulfils the requirements for Class III with  $U_{oc}$ : 6 kV

## Ordering data

Version
without telecomm. contact
with telecomm. contact

Type	Qty.	Order No.
PU II 2+1 550V/40kA	1	8882340000
PU II 2+1R 550V/40kA	1	8882350000

Type	Qty.	Order No.
PU II 2+1 1000V DC	1	8882340001
PU II 2+1R 1000V DC	1	8882350001

## Note

## Accessories

Note  
 Plug-in spare arrester PU II 0 550V / 40kA - 8860120000  
 Plug-in spare arrester PU II 0 N-PE 280V / 40kA - 8871940000

Plug-in spare arrester PU II 0 550V / 40kA - 8860120000  
 Plug-in spare arrester PU II 0 N-PE 280V / 40kA - 8871940000

Plug-in spare arrester PU II 0 550V / 40kA - 8860120000  
 Plug-in spare arrester PU II 0 N-PE 280V / 40kA - 8871940000

Surge protection for  
low-voltage supplies

C



**Class II with varistors**

**Class II with varistors**

- Surge protection of class II with Uc: 550 V
- plug-in varistor top section
  - coded voltage level, var. voltg.
  - high energy absorption with short response time
  - 180° rotatable insert
  - no follow current
  - installation in Insta distributor
  - thermal safety function
  - coordination between class I with Up: <1.5 kV

**PU II 4/R 550 V / 40 kA**

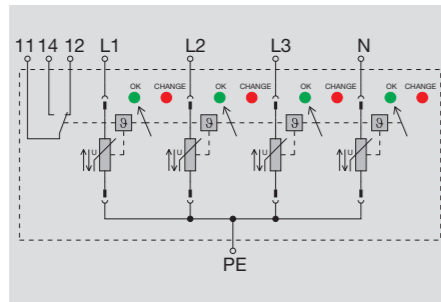

**PU II 3/R 550 V / 40 kA**

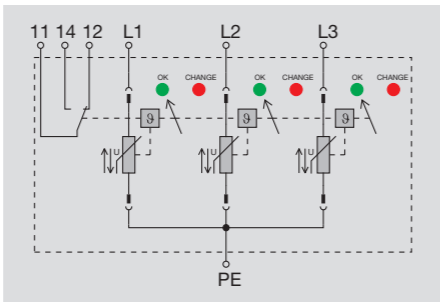

**Technical data**

Technical data	PU II 4/R 550 V / 40 kA	PU II 3/R 550 V / 40 kA
Nominal voltage	470 V / 690 V	470 V / 690 V
max. continuous voltage, Uc (AC)	550 V	550 V
max. continuous voltage, Uc (DC)	745 V	745 V
Requirements class to IEC 61643-1	Class II *	Class II *
Rated discharge current (8/20 µs)	20 kA	20 kA
Limiting discharge current (8/20 µs)	40 kA	40 kA
Discharge current, max. (8/20 µs)	150 kA	110 kA
Response time	≤ 25 ns	≤ 25 ns
Fuse, max.	125 A gL	125 A gL
Protection level at In (Up)	< 2650 V	< 2650 V
Protection level at 5 kA (Up)	< 1700 V	< 1700 V
Temporary surge - U <sub>TDV</sub>	550 V	550 V
Optical function indicator	green = OK; red = arrester faulty, replace	green = OK; red = arrester faulty, replace
Signalling contact	250 V 1A 1CO at PU II 4 R	250 V 1A 1CO at PU II 3 R
Design	4 unit widths; installation housing	3 unit widths; installation housing
Ambient temperature (operational)	-40 ... 80°C	-40 ... 80°C
Storage temperature	-40 ... 85°C	-40 ... 85°C
Approvals	CE, ÖVE, cURus in preparation	CE, ÖVE, cURus in preparation

Dimensions	without telecomm. contact	with telecomm. contact	without telecomm. contact	with telecomm. contact
Clamping range (rating- / min. / max.)	25 / 4 / 25	25 / 4 / 25	25 / 4 / 25	25 / 4 / 25
Length x width x height	90 x 72 x 64	97 x 72 x 64	90 x 54 x 64	97 x 54 x 64

\* This product also fulfils the requirements for Class III with Uoc: 6 kV

**Ordering data**

Version	Type	Qty.	Order No.	Type	Qty.	Order No.
without telecomm. contact	PU II 4 550V/40kA	1	8860060000	PU II 3 550V/40kA	1	8860080000
with telecomm. contact	PU II 4 R 550V/40kA	1	8860070000	PU II 3 R 550V/40kA	1	8860090000

**Accessories**

Note	Plug-in spare arrester PU II 0 550V / 40kA - 8860120000	Plug-in spare arrester PU II 0 550V / 40kA - 8860120000
------	---	---



**Class II with varistors**

- Surge protection of class II with Uc: 550 V
- plug-in varistor top section
  - coded voltage level, var. volts.
  - high energy absorption with short response time
  - 180° rotatable insert
  - no follow current
  - installation in Insta distributor
  - thermal safety function
  - coordination between class I with Up: <1.5 kV

**PU II 2/R 550 V / 40 kA**

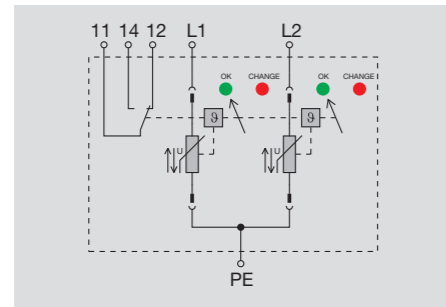

**PU II 1/R 550 V / 40 kA**

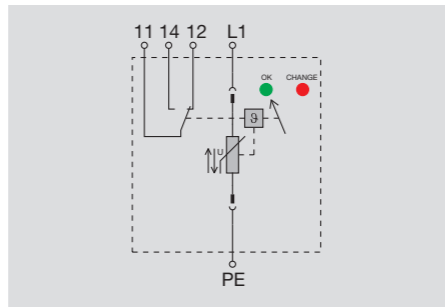

Surge protection for low-voltage supplies



**Technical data**

Technical data	without telecomm. contact	with telecomm. contact	without telecomm. contact	with telecomm. contact
Nominal voltage	470 V	470 V	470 V	470 V
max. continuous voltage, Uc (AC)	550 V	550 V	550 V	550 V
max. continuous voltage, Uc (DC)	745 V	745 V	745 V	745 V
Requirements class to IEC 61643-1	Class II *	Class II *	Class II *	Class II *
Rated discharge current (8/20 µs)	20 kA	20 kA	20 kA	20 kA
Limiting discharge current (8/20 µs)	40 kA	40 kA	40 kA	40 kA
Discharge current, max. (8/20 µs)	75 kA	75 kA	40 kA	40 kA
Response time	≤ 25 ns	≤ 25 ns	≤ 25 ns	≤ 25 ns
Fuse, max.	125 A gL	125 A gL	125 A gL	125 A gL
Protection level at In (Up)	< 2650 V	< 2650 V	< 2650 V	< 2650 V
Protection level at 5 kA (Up)	< 1700 V	< 1700 V	< 1700 V	< 1700 V
Temporary surge - U <sub>TDV</sub>	550 V	550 V	550 V	550 V
Optical function indicator	green = OK; red = arrester faulty, replace	green = OK; red = arrester faulty, replace	green = OK; red = arrester faulty, replace	green = OK; red = arrester faulty, replace
Signalling contact	250 V 1A 1CO at PU II 2 R	250 V 1A 1CO at PU II 1 R	250 V 1A 1CO at PU II 2 R	250 V 1A 1CO at PU II 1 R
Design	2 unit widths; installation housing	1 unit width; installation housing	2 unit widths; installation housing	1 unit width; installation housing
Ambient temperature (operational)	-40 ... 80°C	-40 ... 80°C	-40 ... 80°C	-40 ... 80°C
Storage temperature	-40 ... 85°C	-40 ... 85°C	-40 ... 85°C	-40 ... 85°C
Approvals	CE, ÖVE, cURus in preparation	CE, ÖVE, cURus in preparation	CE, ÖVE, cURus in preparation	CE, ÖVE, cURus in preparation

**Dimensions**

Dimensions	without telecomm. contact	with telecomm. contact	without telecomm. contact	with telecomm. contact
Clamping range (rating- / min. / max.)	25 / 4 / 25	25 / 4 / 25	25 / 4 / 25	25 / 4 / 25
Length x width x height	90 x 36 x 64	97 x 36 x 64	90 x 18 x 64	97 x 18 x 64

**Note** \* This product also fulfils the requirements for Class III with Uoc: 6 kV

**Ordering data**

Version	Type	Qty.	Order No.	Type	Qty.	Order No.
without telecomm. contact	PU II 2 550V/40kA	1	8860100000	PU II 1 550V/40kA	1	8860040000
with telecomm. contact	PU II 2 R 550V/40kA	1	8860110000	PU II 1 R 550V/40kA	1	8860050000

**Note**

**Accessories**

Accessories	without telecomm. contact	with telecomm. contact
<b>Note</b>	Plug-in spare arrester PU II 0 550V / 40kA - 8860120000	Plug-in spare arrester PU II 0 550V / 40kA - 8860120000

**Class II with varistors**

**Class II with varistors**

- Surge protection of class II with  $U_c$ : 75 V
- plug-in varistor top section
  - coded voltage level, var. voltgs.
  - high energy absorption with short response time
  - 180° rotatable insert
  - no follow current
  - installation in Insta distributor
  - thermal safety function

**PU II 2/R 75 V / 40 kA**

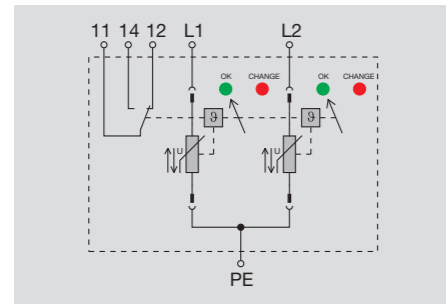

**PU II 1/R 75 V / 40 kA**

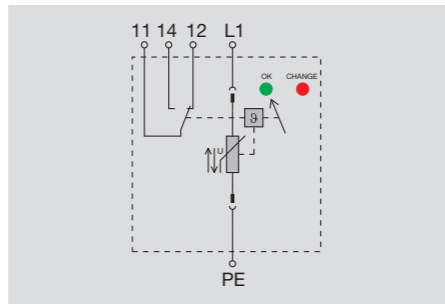

**Technical data**

Technical data	
Nominal voltage	60 V
max. continuous voltage, $U_c$ (AC)	75 V
max. continuous voltage, $U_c$ (DC)	100 V
Requirements class to IEC 61643-1	Class II *
Rated discharge current (8/20 $\mu$ s)	20 kA
Limiting discharge current (8/20 $\mu$ s)	40 kA
Discharge current, max. (8/20 $\mu$ s)	75 kA
Response time	$\leq 25$ ns
Fuse, max.	125 A gL
Protection level at In ( $U_p$ )	< 700 V
Protection level at 5 kA ( $U_p$ )	< 300 V
Temporary surge - $U_{TGV}$	75 V
Optical function indicator	green = OK; red = arrester faulty, replace
Signalling contact	250 V 1A 1CO at PU II 2 R
Design	2 unit widths; installation housing
Ambient temperature (operational)	-40 ... 80 °C
Storage temperature	-40 ... 85 °C
Approvals	CE, ÖVE, cURus in preparation

without telecomm. contact		with telecomm. contact	
25 / 4 / 25	25 / 4 / 25	90 x 36 x 64	97 x 36 x 64
* This product also fulfils the requirements for Class III with $U_{oc}$ : 6 kV			

without telecomm. contact		with telecomm. contact	
25 / 4 / 25	25 / 4 / 25	90 x 18 x 64	97 x 18 x 64
* This product also fulfils the requirements for Class III with $U_{oc}$ : 6 kV			

**Dimensions**

Clamping range (rating- / min. / max.)	mm²
Length x width x height	mm

without telecomm. contact		with telecomm. contact	
25 / 4 / 25	25 / 4 / 25	90 x 36 x 64	97 x 36 x 64

without telecomm. contact		with telecomm. contact	
25 / 4 / 25	25 / 4 / 25	90 x 18 x 64	97 x 18 x 64

**Note**

\* This product also fulfils the requirements for Class III with  $U_{oc}$ : 6 kV

\* This product also fulfils the requirements for Class III with  $U_{oc}$ : 6 kV

**Ordering data**

Version
without telecomm. contact
with telecomm. contact

Type	Qty.	Order No.
PU II 2 75V/40kA	1	8860130000
PU II 2 R 75V/40kA	1	8860140000

Type	Qty.	Order No.
PU II 1 75V/40kA	1	8860150000
PU II 1 R 75V/40kA	1	8860160000

**Note**

Plug-in spare arrester PU II 0 75V / 40kA - 8879950000

Plug-in spare arrester PU II 0 75V / 40kA - 8879950000

**Accessories**

**Note**

Plug-in spare arrester PU II 0 75V / 40kA - 8879950000

Plug-in spare arrester PU II 0 75V / 40kA - 8879950000

Surge protection for  
low-voltage supplies

C



## Transient and permanent surge voltages

Transient surge voltages are active for time periods ranging from  $\mu\text{s}$  to  $\text{ms}$ . The surge voltage peak, however, can reach up to several thousand volts during this short time period. The causes for this include direct or remote lightning strikes, short-term interruptions, or switching operations involving large loads. Electrical facilities can be protected by the use of surge arresters. The arresters safely short-circuit dangerous voltage differences and discharge this energy.

Permanent surge voltages can occur for several seconds or several hours. Thus this voltage exceeds the tolerance level of the voltage rating. Permanent surge voltage arise from fluctuations in unstable voltage supplies. A neutral-wire interruption in a three-phase system can also lead to an unacceptably high voltage level. This permanent surge voltage is a prohibited state of operations. It can lead to the destruction of electrical devices and surge arresters.

The PU Vlimit is suitable for detecting permanent raised voltages. Together with an RCD (residual current device) it can cut-out to 30 mA or 0.3 A.

The PU Vlimit detects voltages greater than 255 V...275 V. It then sends a short pulse to the PE. The RCD recognizes this residual current and switches off. The normal mains supply voltage must be reactivated in order for the RCD to be switched back on.

The PU Vlimit can be used in a three-phase system with 230 / 400 V, or in a single-phase system with 230 V in conjunction with a Class II arrester from Weidmüller's PU II series.

The operation of the RCD can be tested by pressing the button before it is installed by a technician. The RCD must trigger.

The RCD can also be triggered by pressing the button on the PU Vlimit.

The earth (ground) resistance must be  $< 166 \Omega$ .

### Function

The PU Vlimit measures the mains supply voltage for voltage increases. As soon as the voltage is in the 255 V...275 V range for more than 4 seconds, a pulse is triggered on the PE or RCD. The RCD can be turned back on only when there is no permanent surge voltage.

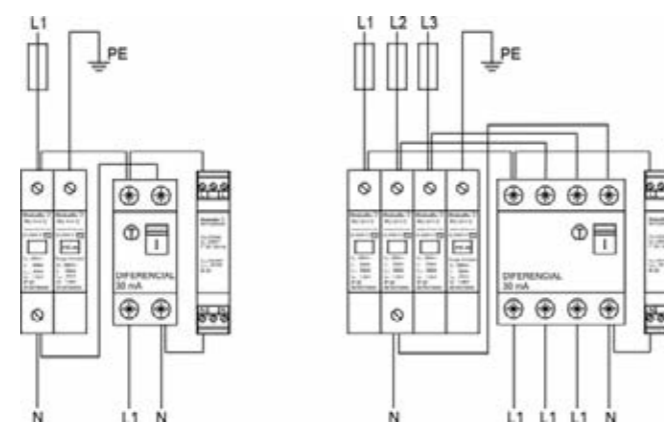

Protection from permanent surge voltages

- Quick response time of < 1 sec
- Slim design of only 18 mm
- Function indicator
- Test function

**PU VLIMIT 225-275 V**

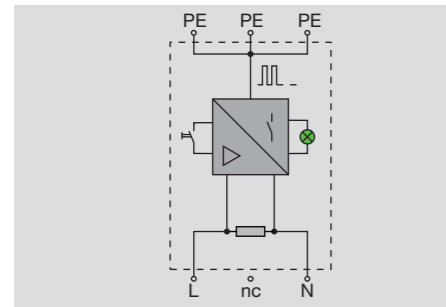

**Technical data**

Nominal voltage	230 V / 400 V AC 50-60Hz
Switching threshold	255 V..275 V
max. continuous voltage, U <sub>c</sub>	400 V AC
Suitable for RCD	30 mA / 300 mA
Response time t <sub>a</sub>	< 315 V, t <sub>a</sub> < 4 s / U > 315 V, t <sub>a</sub> < 1 s
Protection class	IP20
Optical function indicator	Green LED flashes slowly: PU Vlimit is connected to the rated voltage Green LED flashes quickly: The permanent surge voltage is measured.
Ambient temperature (operational)	-20 °C ... 55 °C
Storage temperature	-40 °C ... 70 °C
Connection cross-section	0.5 ... 2.5 mm <sup>2</sup>

<b>Dimensions</b>	
Length x width x height	mm 91 x 18 x 61

<b>Note</b>	National regulations governing the installation must be followed.
-------------	---

**Ordering data**

Version	Type	Qty.	Order No.
	PU VLIMIT 255-275V	1	8881840000

<b>Note</b>	
-------------	--

**Accessories**

<b>Note</b>	
-------------	--



# Class III with varistors

## Low-voltage consumer installations, small distribution units and electronics

Surge protection module of class III (D-arresters)

Our surge protection modules PU III and PU D protect low-voltage consumer installations and electronic devices from voltage surges that occur through atmospheric discharge (lightning) or switching activities (transients).

The PU III and the PU D can be built into small distribution boards or into multi-floor distribution boards.

The PU III satisfies the requirements of IEC 61643-1.

The PU D satisfies the requirements of DIN VDE 0675, part 6, class C, Nov 1989, part 6, A2 (Oct 1996) and IEC 61643-1 (Feb 1998).



## Electrical connection

The PU III or PU D surge protection device is installed after the PU II arrester and before the device / consumer to be protected. It can protect electrical circuits of up to 16 A. An installation can be done in a consumer unit for an electrical circuit that protects monitors, for example.

## Functional check and maintenance

Varistors can exhibit high temperatures as a result of ageing. In low-voltage systems, this can result in fire. The integrated temperature monitoring device automatically disconnects the varistor from the power supply. This disconnection is indicated by the warning lamp being extinguished. Types PU III and PU DS also have a built-in switching contact for signalling.

The back-up fuse you install depends on the conductor cross-section and type of routing. For PU III or PU D arresters, the maximum power rating is 16 A.

The connection is rated to IEC 947-7-1 for the following cross-sections:

solid conductor: 0.5...2.5 mm<sup>2</sup>

flexible conductor: 0.5...2.5 mm<sup>2</sup>

## Dimensioned drawing PU III

Overall width  
18 mm

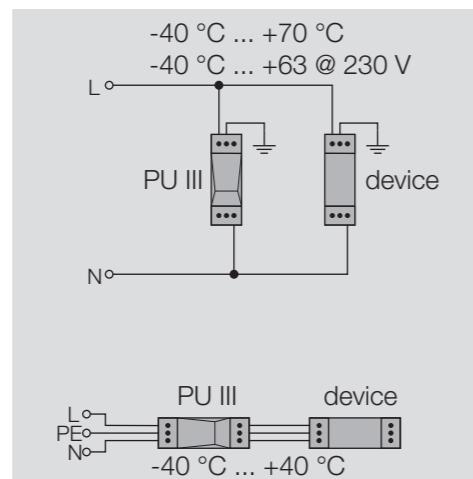
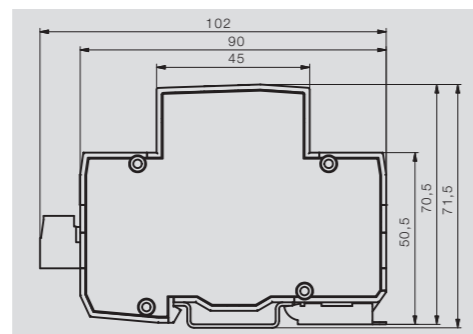

The standard implementation for operating the PU III products is a series connection to the end device. Under this operational state, the protective device can bear a long-term load of 16 A. For higher demands, the parallel circuitry is used.

**Class III with varistors**

- Class III surge protection
- suitable for protecting terminals
- installed in the vicinity of the equipment to be protected
- with remote signalling contact

**PU III R 230 V/6 kV**

Use as device protection

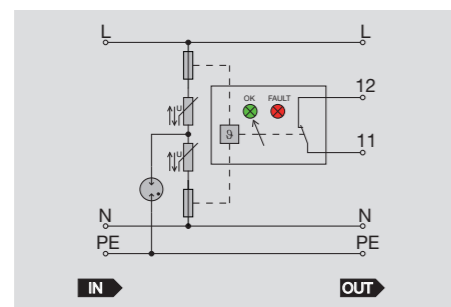

**PU III R 120 V/6 kV**

Use as device protection

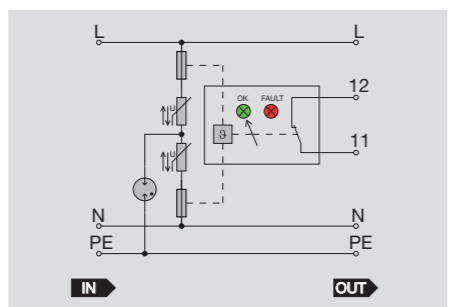

Surge protection for low-voltage supplies



**Technical data**

Rated voltage (AC)	230 V
Rated voltage (DC)	260 V
max. continuous voltage, U <sub>c</sub> (AC)	260 V
max. continuous voltage, U <sub>c</sub> (DC)	260 V
Requirements class to IEC 61643-1	Class III
Combined pulse U <sub>oc</sub>	6 kV
Rated discharge current per path (8/20 μs)	3 kA
Response time	≤ 150 ns
Fuse, max.	16 A
Protection level Up L - N	≤ 1200 V
Protection level Up L (PE) - N	≤ 1800 V
Protection level Up at nominal discharge current (8/20 μs) per path	< 1300 V
Optical function indicator	green LED = OK
Signalling contact	250 V 1A 1NO
Design	1 unit width; Installation housing
Ambient temperature (operational)	-40 ... 40 °C (Dependent on application)
Storage temperature	-40 ... 40 °C
Approvals	CE;cULus in preparation

Rated voltage (AC)	120 V
Rated voltage (DC)	180 V
max. continuous voltage, U <sub>c</sub> (AC)	150 V
max. continuous voltage, U <sub>c</sub> (DC)	200 V
Requirements class to IEC 61643-1	Class III
Combined pulse U <sub>oc</sub>	6 kV
Rated discharge current per path (8/20 μs)	3 kA
Response time	≤ 150 ns
Fuse, max.	16 A
Protection level Up L - N	≤ 650 V
Protection level Up L (PE) - N	≤ 1500 V
Protection level Up at nominal discharge current (8/20 μs) per path	< 700 V
Optical function indicator	green LED = OK
Signalling contact	250 V 1A 1NO
Design	1 unit width; Installation housing
Ambient temperature (operational)	-40 ... 40 °C (Dependent on application)
Storage temperature	-40 ... 40 °C
Approvals	CE;cULus in preparation

Rated voltage (AC)	120 V
Rated voltage (DC)	180 V
max. continuous voltage, U <sub>c</sub> (AC)	150 V
max. continuous voltage, U <sub>c</sub> (DC)	200 V
Requirements class to IEC 61643-1	Class III
Combined pulse U <sub>oc</sub>	6 kV
Rated discharge current per path (8/20 μs)	3 kA
Response time	≤ 150 ns
Fuse, max.	16 A
Protection level Up L - N	≤ 650 V
Protection level Up L (PE) - N	≤ 1500 V
Protection level Up at nominal discharge current (8/20 μs) per path	< 700 V
Optical function indicator	green LED = OK
Signalling contact	250 V 1A 1NO
Design	1 unit width; Installation housing
Ambient temperature (operational)	-40 ... 40 °C (Dependent on application)
Storage temperature	-40 ... 40 °C
Approvals	CE;cULus in preparation

<b>Dimensions</b>	
Clamping range (rating- / min. / max.)	mm²
Length x width x height	mm

<b>Screw connection</b>	
Clamping range (rating- / min. / max.)	mm²
Length x width x height	mm

<b>Screw connection</b>	
Clamping range (rating- / min. / max.)	mm²
Length x width x height	mm

**Ordering data**

Type	Qty.	Order No.
PU III R 230V/6kV	1	8860330000

Type	Qty.	Order No.
PU III R 230V/6kV	1	8860330000

Type	Qty.	Order No.
PU III R 120V/6kV	1	8860340000

Note

Note

Note

**Accessories**

Note

Note

Note



**Class III with varistors**

**Class III with varistors**

- Class III surge protection
- suitable for protecting terminals
- installed in the vicinity of the equipment to be protected
- with remote signalling contact

**PU III R 48 V/4 kV**

Use as device protection



**PU III R 24 V/4 kV**

Use as device protection



C



**Technical data**

<b>Technical data</b>	
Rated voltage (AC)	48 V
Rated voltage (DC)	80 V
max. continuous voltage, U <sub>c</sub> (AC)	60 V
max. continuous voltage, U <sub>c</sub> (DC)	85 V
Requirements class to IEC 61643-1	Class III
Combined pulse U <sub>oc</sub>	4 kV
Rated discharge current per path (8/20 μs)	2 kA
Response time	≤ 150 ns
Fuse, max.	16 A
Protection level Up L - N	≤ 550 V
Protection level Up L (PE) - N	≤ 850 V
Protection level Up at nominal discharge current (8/20 μs) per path	< 300 V
Optical function indicator	green LED = OK
Signalling contact	250 V 1A 1NO
Design	1 unit width; Installation housing
Ambient temperature (operational)	-40 ... 40 °C (Dependent on application)
Storage temperature	-40 ... 40 °C
Approvals	CE;cULus in preparation

<b>Technical data</b>	
Rated voltage (AC)	24 V
Rated voltage (DC)	38 V
max. continuous voltage, U <sub>c</sub> (AC)	32 V
max. continuous voltage, U <sub>c</sub> (DC)	38 V
Requirements class to IEC 61643-1	Class III
Combined pulse U <sub>oc</sub>	4 kV
Rated discharge current per path (8/20 μs)	2 kA
Response time	≤ 150 ns
Fuse, max.	16 A
Protection level Up L - N	≤ 550 V
Protection level Up L (PE) - N	≤ 850 V
Protection level Up at nominal discharge current (8/20 μs) per path	< 300 V
Optical function indicator	green LED = OK
Signalling contact	250 V 1A 1NO
Design	1 unit width; Installation housing
Ambient temperature (operational)	-40 ... 40 °C (Dependent on application)
Storage temperature	-40 ... 40 °C
Approvals	CE;cULus in preparation

<b>Technical data</b>	
Rated voltage (AC)	24 V
Rated voltage (DC)	38 V
max. continuous voltage, U <sub>c</sub> (AC)	32 V
max. continuous voltage, U <sub>c</sub> (DC)	38 V
Requirements class to IEC 61643-1	Class III
Combined pulse U <sub>oc</sub>	4 kV
Rated discharge current per path (8/20 μs)	2 kA
Response time	≤ 150 ns
Fuse, max.	16 A
Protection level Up L - N	≤ 550 V
Protection level Up L (PE) - N	≤ 850 V
Protection level Up at nominal discharge current (8/20 μs) per path	< 300 V
Optical function indicator	green LED = OK
Signalling contact	250 V 1A 1NO
Design	1 unit width; Installation housing
Ambient temperature (operational)	-40 ... 40 °C (Dependent on application)
Storage temperature	-40 ... 40 °C
Approvals	CE;cULus in preparation

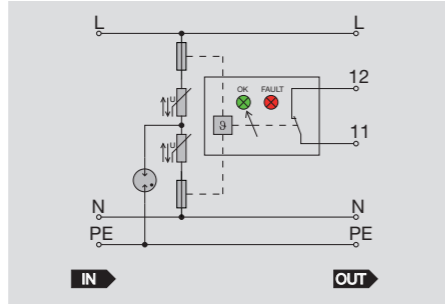
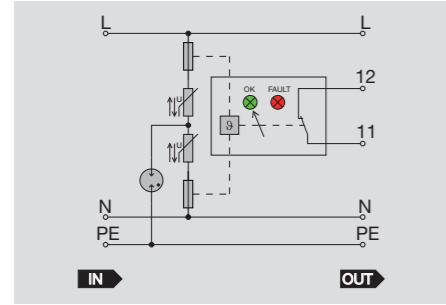

<b>Dimensions</b>	
Clamping range (rating- / min. / max.)	mm²
Length x width x height	mm

<b>Screw connection</b>	
Clamping range (rating- / min. / max.)	mm²
Length x width x height	mm

<b>Screw connection</b>	
Clamping range (rating- / min. / max.)	mm²
Length x width x height	mm

**Ordering data**

Type	Qty.	Order No.
PU III R 48V/4kV	1	8860350000

Type	Qty.	Order No.
PU III R 48V/4kV	1	8860350000

Type	Qty.	Order No.
PU III R 24V/4kV	1	8860360000

Note

Note

Note

**Accessories**

Note

Note

Note

### Class III with varistors

- Class III surge protection
- suitable for protecting terminals
  - installed in the vicinity of the equipment to be protected
  - with remote signalling contact

### PU III R 12 V/4 kV

Use as device protection

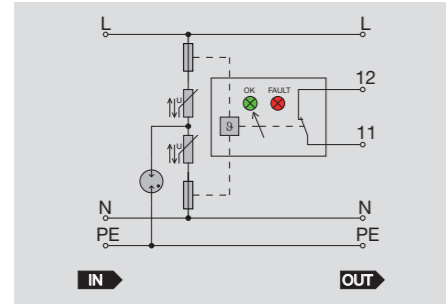

### Technical data

Rated voltage (AC)	12 V
Rated voltage (DC)	14 V
max. continuous voltage, U <sub>c</sub> (AC)	20 V
max. continuous voltage, U <sub>c</sub> (DC)	18 V
Requirements class to IEC 61643-1	Class III
Combined pulse U <sub>oc</sub>	3 kV
Rated discharge current per path (8/20 μs)	2 kA
Response time	≤ 150 ns
Fuse, max.	16 A
Protection level Up L - N	≤ 550 V
Protection level Up L (PE) - N	≤ 850 V
Protection level Up at nominal discharge current (8/20 μs) per path	< 200 V
Optical function indicator	green LED = OK
Signalling contact	250 V 1A 1NO
Design	1 unit width; Installation housing
Ambient temperature (operational)	-40 ... 40 °C (Dependent on application)
Storage temperature	-40 ... 40 °C
Approvals	CE;cULus in preparation

Rated voltage (AC)	12 V
Rated voltage (DC)	14 V
max. continuous voltage, U <sub>c</sub> (AC)	20 V
max. continuous voltage, U <sub>c</sub> (DC)	18 V
Requirements class to IEC 61643-1	Class III
Combined pulse U <sub>oc</sub>	3 kV
Rated discharge current per path (8/20 μs)	2 kA
Response time	≤ 150 ns
Fuse, max.	16 A
Protection level Up L - N	≤ 550 V
Protection level Up L (PE) - N	≤ 850 V
Protection level Up at nominal discharge current (8/20 μs) per path	< 200 V
Optical function indicator	green LED = OK
Signalling contact	250 V 1A 1NO
Design	1 unit width; Installation housing
Ambient temperature (operational)	-40 ... 40 °C (Dependent on application)
Storage temperature	-40 ... 40 °C
Approvals	CE;cULus in preparation

### Dimensions

Clamping range (rating- / min. / max.)	mm <sup>2</sup>	2.5 / 0.5 / 2.5
Length x width x height	mm	102 x 18 x 71.5

### Screw connection

Clamping range (rating- / min. / max.)	mm <sup>2</sup>	2.5 / 0.5 / 2.5
Length x width x height	mm	102 x 18 x 71.5

### Note

### Ordering data

Type	Qty.	Order No.
PU III R 12V/4kV	1	8883740000

### Note

### Accessories

#### Note



**Class III with varistors**

**Class III with varistors**

- Class III surge protection
- suitable for protecting terminals
- installed in the vicinity of the equipment to be protected
- with remote signalling contact

**PU D 230 V AC 16 A**

Use as device protector



**PU D 115 V AC 16 A**

Use as device protector

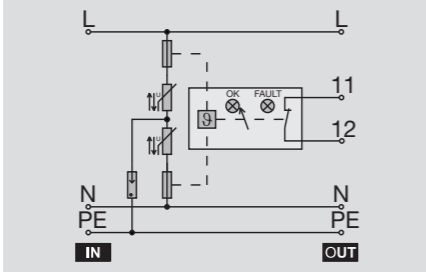
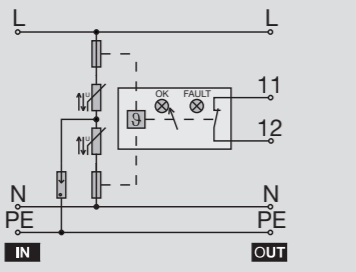

**Technical data**

Technical data	PU D 230 V AC 16 A	PU D 115 V AC 16 A
Rated voltage (AC)	230 V	115 V
Rated voltage (DC)		
max. continuous voltage, U <sub>c</sub> (AC)	275 V	130 V
max. continuous voltage, U <sub>c</sub> (DC)		
Requirements class to IEC 61643-1	Class III	Class III
Combined pulse U <sub>oc</sub>	4 kV	4 kV
Rated discharge current per path (8/20 μs)	2.5 kA	2.5 kA
Discharge current, max. (8/20 μs)	7 kA	7 kA
Response time	≤ 150 ns	≤ 150 ns
Fuse, max.	16 A	16 A
Protection level Up (typical)	850 V	480 V
Optical function indicator	green LED = OK; red LED = fault	green LED = OK; red LED = fault
Signalling contact	250 V 1 A 1 NC	250 V 1 A 1 NC
Design	Installation housing	Installation housing
Ambient temperature (operational)	-25 ... 55°C	-25 ... 55°C
Storage temperature	-40 ... 55°C	-40 ... 55°C
Approvals	CE	CE

Dimensions	Screw connection	Screw connection
Clamping range (rating- / min. / max.)	2.5 / 0.5 / 2.5	2.5 / 0.5 / 2.5
Length x width x height	91 x 54 x 61	91 x 54 x 61

**Ordering data**

Type	Qty.	Order No.	Type	Qty.	Order No.
PU D 230V 16A	1	on demand	PU D 115Vac 16A	1	on demand

Note

**Accessories**

Note

**Class III with varistors**

- Class III surge protection
- suitable for protecting terminals
- installed in the vicinity of the equipment to be protected
- with remote signalling contact

**PU 3 D 230 V / 400 V AC 16 A**

Use as device protector

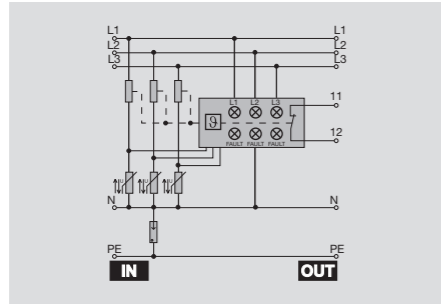

**PO D S / AS 230 V 16 A**

Use as device protector

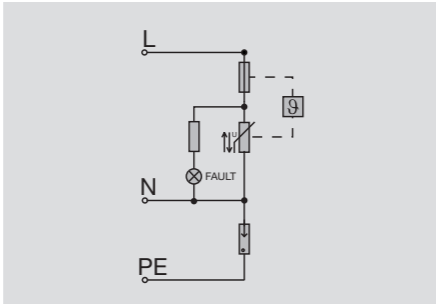

Surge protection for low-voltage supplies

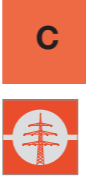

**Technical data**

Technical data	PU 3 D 230 V / 400 V AC 16 A	PO D S / AS 230 V 16 A
Rated voltage (AC)	230 V	230 V
Rated voltage (DC)	275 V	275 V
max. continuous voltage, U <sub>c</sub> (AC)	275 V	275 V
max. continuous voltage, U <sub>c</sub> (DC)	275 V	275 V
Requirements class to IEC 61643-1	Class III	Class III
Combined pulse U <sub>oc</sub>	4 kV	4 kV
Rated discharge current per path (8/20 μs)	6.5 kA	2.5 kA
Discharge current, max. (8/20 μs)	18 kA	5 kA
Response time	≤ 150 ns	sym/ asym: ≤ 100 ns
Fuse, max.	16 A	16 A
Protection level Up (typical)	850 V	1500 V
Optical function indicator	green LED = OK; red LED = fault	green LED
Signalling contact	250 V 1 A 1 NC	
Design	Installation housing	Miscellaneous
Ambient temperature (operational)	-25 ... 55°C	-25 ... 55°C
Storage temperature	-40 ... 55°C	-40 ... 60°C
Approvals	CE	CE

**Dimensions**

Clamping range (rating- / min. / max.)	mm <sup>2</sup>	2.5 / 0.5 / 2.5
Length x width x height	mm	91 x 54 x 61

**Note**

**Screw connection**

Clamping range (rating- / min. / max.)	mm <sup>2</sup>	2.5 / 0.5 / 2.5
Length x width x height	mm	91 x 54 x 61

**with audible signal      Without audible signal**

Clamping range (rating- / min. / max.)	mm <sup>2</sup>	2.5 / 0.5 / 2.5
Length x width x height	mm	91 x 54 x 61

**Ordering data**

Type	Qty.	Order No.
PU 3 D 230V/400Vac 16A	1	on demand
PO D AS	1	1115490000
PO D S	1	1115500000

**Note**

PO D AS with audible signal

**Accessories**

**Note**

**Class III adapter plug**

# Class III adapter plug

**PU D ZS pluggable surge protection**

Class III surge protection

The PU D ZS pluggable surge protection device provides protection against transient overvoltages for equipment plugged into earthed power sockets. The pluggable surge protection with its earthed power socket is designed for 230 V/16 A, fulfils the requirements of class III to IEC 61643-1 and is used in conjunction with class II, the PU C protection.

The PU D ZS is fitted with components to monitor varistor temperature. In the event of an excessive temperature rise due to pulses from the mains supply, these disconnect the unit. The integral red warning lamp indicates that protection is no longer provided. The PU D ZS must then be replaced.

**PU D ZS analogue surge protection device**

Besides standard telephones, an analogue installation can also be used to transmit data services such as fault signalling systems and Internet. Because, in addition to telephones, other devices such as fax machines and modems are connected to the analogue line, the risk of damage due to transient interference phenomena such as voltage surges is greater. To provide protection against these overvoltages, a combined

surge protection device for analogue lines and mains voltages is incorporated. The basic version of this power socket adapter is protected by a two-stage surge protection device using a gas discharge tube and fast-acting suppression diodes.

The gas discharge tube diverts a large amount of electrical energy; the suppression diodes ensure a low residual voltage.

**PU D ZS digital surge protection device**

This power socket adapter is available for Uko and So interfaces.

To provide protection against these voltage surges, a combined surge protection device for digital lines and mains voltage is incorporated. The basic version of this power socket adapter is protected by a two-stage surge protection device using a gas discharge tube and fast-acting suppression diodes.

The gas discharge tube diverts a large amount of electrical energy; the suppression diodes ensure a low residual voltage. In the case of the PU D ZS with RJ45 sockets, a connecting cable with RJ45 plugs at both ends is included with the product.

The PU D ZS TV is for protection of radios or TVs, for example. The device protects both the power supplies and the antenna connection.

The PU D ZS Cat.6 can protect Ethernet connections of both category 5 and category 6.

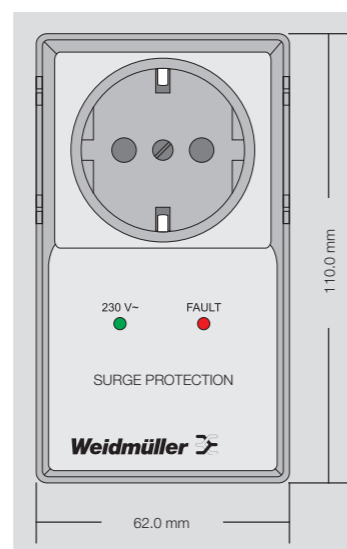
**Dimensions PU D ZS**

**Class III adapter plug**

**Class III adapter plug**

- Class III surge protection
- With visual status display
- Suitable for earthed (grounded) socket outlets

**PU D ZS**



**PU D ZS AS**

With additional acoustic signal



Surge protection for low-voltage supplies

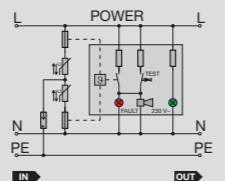
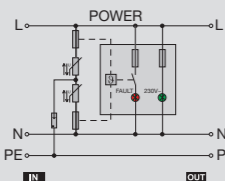

**Technical data**

Rated voltage (AC)	230 V
max. continuous voltage, U <sub>c</sub> (AC)	275 V
Operating current, I <sub>max</sub> to DIN VDE 0675-6	16 A
Requirements class to IEC 61643-1	Requirements class D
Combined pulse U <sub>oc</sub>	Class III
	4 kV
Discharge current, max. (8/20 μs)	5 kA
Fuse, max.	16 A
Response time	≤ 150 ns
Protection level on output side sym., input 8/20 μs, typ.	600 V
Protection level on output side unsym., input 8/20 μs, typ.	1500 V
Leakage current at U <sub>n</sub>	1 μA
Optical function indicator	green LED = OK; red LED = fault
Pollution severity	2
Surge category	III
Ambient temperature (operational)	0 ... 60°C
Storage temperature	-25 ... 85°C

Rated voltage (AC)	230 V
max. continuous voltage, U <sub>c</sub> (AC)	275 V
Operating current, I <sub>max</sub> to DIN VDE 0675-6	16 A
Requirements class to IEC 61643-1	Requirements class D
Combined pulse U <sub>oc</sub>	Class III
	4 kV
Discharge current, max. (8/20 μs)	5 kA
Fuse, max.	16 A
Response time	≤ 150 ns
Protection level on output side sym., input 8/20 μs, typ.	600 V
Protection level on output side unsym., input 8/20 μs, typ.	1500 V
Leakage current at U <sub>n</sub>	1 μA
Optical function indicator	green LED = OK; red LED = fault
Pollution severity	2
Surge category	III
Ambient temperature (operational)	0 ... 60°C
Storage temperature	-25 ... 85°C

Rated voltage (AC)	230 V
max. continuous voltage, U <sub>c</sub> (AC)	275 V
Operating current, I <sub>max</sub> to DIN VDE 0675-6	16 A
Requirements class to IEC 61643-1	Requirements class D
Combined pulse U <sub>oc</sub>	Class III
	4 kV
Discharge current, max. (8/20 μs)	5 kA
Fuse, max.	16 A
Response time	≤ 150 ns
Protection level on output side sym., input 8/20 μs, typ.	600 V
Protection level on output side unsym., input 8/20 μs, typ.	1500 V
Leakage current at U <sub>n</sub>	1 μA
Optical function indicator	green LED = OK; red LED = fault
Pollution severity	2
Surge category	III
Ambient temperature (operational)	0 ... 60°C
Storage temperature	-25 ... 85°C

**General data**

Input voltage, max.	
Rated current I <sub>n</sub> , max.	
Standard signal	
Rated discharge current (8/20 μs)	
Total current	
Response time, typical	
Resistance per path	
Cut-off frequency f <sub>g</sub> , 600 Ω system	
Transistor output, positive-switching	
Residual voltage at output for input pulse of 1 kV/μs	
Residual voltage at output for 8/20μs and input pulse of 5kA	

Input voltage, max.	
Rated current I <sub>n</sub> , max.	
Standard signal	
Rated discharge current (8/20 μs)	
Total current	
Response time, typical	
Resistance per path	
Cut-off frequency f <sub>g</sub> , 600 Ω system	
Transistor output, positive-switching	
Residual voltage at output for input pulse of 1 kV/μs	
Residual voltage at output for 8/20μs and input pulse of 5kA	

Input voltage, max.	
Rated current I <sub>n</sub> , max.	
Standard signal	
Rated discharge current (8/20 μs)	
Total current	
Response time, typical	
Resistance per path	
Cut-off frequency f <sub>g</sub> , 600 Ω system	
Transistor output, positive-switching	
Residual voltage at output for input pulse of 1 kV/μs	
Residual voltage at output for 8/20μs and input pulse of 5kA	

**Dimensions**

Clamping range (rating- / min. / max.)	mm <sup>2</sup>
Length x width x height	mm

**Schuko**

Length x width x height	110 x 62 x 48
-------------------------	---------------

**Schuko**

Length x width x height	110 x 62 x 48
-------------------------	---------------

**Note**

**Ordering data**

Version	without telecomm. contact
---------	---------------------------

Type	Qty.	Order No.
PU D ZS 230V- 16A	1	on demand

Type	Qty.	Order No.
PU D ZS AS	1	on demand

**Note**

**Accessories**

**Note**

## Class III adapter plug

## Class III adapter plug

- Class III surge protection
- with visual function indicator
- suitable for earthed power sockets

## PU D ZS

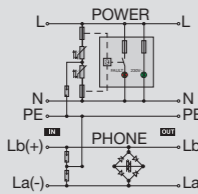
PU D ZS Uk<sub>0</sub> 230 V 16 A

## PU D ZS

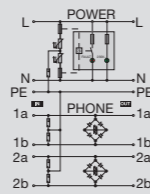
PU D ZS S<sub>0</sub> 230 V 16 A

C

## Technical data

Rated voltage (AC)	230 V
max. continuous voltage, U <sub>c</sub> (AC)	275 V
Operating current, I <sub>max</sub> to DIN VDE 0675-6	16 A
Requirements class to IEC 61643-1	Requirements class D
Combined pulse U <sub>oc</sub>	Class III
	4 kV

Discharge current, max. (8/20 μs)	5 kA
Fuse, max.	16 A
Response time	≤ 150 ns
Protection level on output side sym., input 8/20 μs, typ.	600 V
Protection level on output side unsym., input 8/20 μs, typ.	1500 V
Leakage current at U <sub>n</sub>	1 μA
Optical function indicator	green LED = OK; red LED = fault
Pollution severity	2

Surge category	III
Ambient temperature (operational)	0 ... 60°C
Storage temperature	-25 ... 85°C

## General data

Input voltage, max.	190 V DC
Rated current I <sub>n</sub> , max.	0.45 A
Standard signal	ISDN telephone signal RJ45/RJ11/12
Rated discharge current (8/20 μs)	4 kA
Total current	10 A
Response time, typical	< 5 ns
Resistance per path	1.1 Ω
Cut-off frequency f <sub>g</sub> 600 Ω system	80 MHz
Transistor output, positive-switching	
Residual voltage at output for input pulse of 1 kV/μs	a/b ≤ 270V a-b/PE ≤ 270V
Residual voltage at output for 8/20μs and input pulse of 5kA	a/b ≤ 100V a-b/PE ≤ 100V

## Dimensions

Clamping range (rating- / min. / max.)	mm <sup>2</sup>
Length x width x height	mm

## Note

## Ordering data

Version	without telecomm. contact
---------	---------------------------

## Note

## Accessories

Note	Conductor, RJ 45 at both ends, order No. 8697590000
------	---

Rated voltage (AC)	230 V
max. continuous voltage, U <sub>c</sub> (AC)	275 V
Operating current, I <sub>max</sub> to DIN VDE 0675-6	16 A
Requirements class to IEC 61643-1	Requirements class D
Combined pulse U <sub>oc</sub>	Class III
	4 kV

Discharge current, max. (8/20 μs)	5 kA
Fuse, max.	16 A
Response time	≤ 150 ns
Protection level on output side sym., input 8/20 μs, typ.	600 V
Protection level on output side unsym., input 8/20 μs, typ.	1500 V
Leakage current at U <sub>n</sub>	1 μA
Optical function indicator	green LED = OK; red LED = fault
Pollution severity	2

Surge category	III
Ambient temperature (operational)	0 ... 60°C
Storage temperature	-25 ... 85°C

## General data

Input voltage, max.	190 V DC
Rated current I <sub>n</sub> , max.	0.45 A
Standard signal	ISDN telephone signal RJ45/RJ11/12
Rated discharge current (8/20 μs)	4 kA
Total current	10 A
Response time, typical	< 5 ns
Resistance per path	1.1 Ω
Cut-off frequency f <sub>g</sub> 600 Ω system	80 MHz
Transistor output, positive-switching	
Residual voltage at output for input pulse of 1 kV/μs	a/b ≤ 270V a-b/PE ≤ 270V
Residual voltage at output for 8/20μs and input pulse of 5kA	a/b ≤ 100V a-b/PE ≤ 100V

## Dimensions

Clamping range (rating- / min. / max.)	mm <sup>2</sup>
Length x width x height	mm

## Note

Type	Qty.	Order No.
PU D ZS Uko 230V 16A	1	on demand

## Note

Note	Conductor, RJ 45 at both ends, order No. 8697590000
------	---

Rated voltage (AC)	230 V
max. continuous voltage, U <sub>c</sub> (AC)	275 V
Operating current, I <sub>max</sub> to DIN VDE 0675-6	16 A
Requirements class to IEC 61643-1	Requirements class D
Combined pulse U <sub>oc</sub>	Class III
	4 kV

Discharge current, max. (8/20 μs)	5 kA
Fuse, max.	16 A
Response time	≤ 150 ns
Protection level on output side sym., input 8/20 μs, typ.	600 V
Protection level on output side unsym., input 8/20 μs, typ.	1500 V
Leakage current at U <sub>n</sub>	1 μA
Optical function indicator	green LED = OK; red LED = fault
Pollution severity	2

Surge category	III
Ambient temperature (operational)	0 ... 60°C
Storage temperature	-25 ... 85°C

## General data

Input voltage, max.	190 V
Rated current I <sub>n</sub> , max.	0.45 A
Standard signal	ISDN telephone signal RJ45/RJ11/12
Rated discharge current (8/20 μs)	4 kA
Total current	10 A
Response time, typical	< 5 ns
Resistance per path	1.1 Ω
Cut-off frequency f <sub>g</sub> 600 Ω system	80 MHz
Transistor output, positive-switching	
Residual voltage at output for input pulse of 1 kV/μs	a/b ≤ 270V a-b/PE ≤ 270V
Residual voltage at output for 8/20μs and input pulse of 5kA	a/b ≤ 100V a-b/PE ≤ 100V

## Dimensions

Clamping range (rating- / min. / max.)	mm <sup>2</sup>
Length x width x height	mm

## Note

Type	Qty.	Order No.
PU D ZS 230V- 16A / ISDN So	1	on demand

## Note

Note	Conductor, RJ 45 at both ends, order No. 8697590000
------	---



**Class III adapter plug**

**Class III adapter plug**

- Class III surge protection
- with visual function indicator
- suitable for earthed power sockets

**PU D ZS**

PU D ZS analog 230 V 16 A

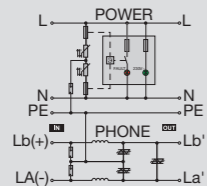

**PU D ZS**

PU D ZS Cat.6

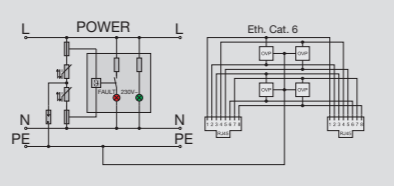

Surge protection for low-voltage supplies

**C**



**Technical data**

Rated voltage (AC)	230 V
max. continuous voltage, U <sub>c</sub> (AC)	275 V
Operating current, I <sub>max</sub> to DIN VDE 0675-6	16 A
Requirements class to IEC 61643-1	Requirements class D
Combined pulse U <sub>oc</sub>	Class III
	4 kV
Discharge current, max. (8/20 μs)	5 kA
Fuse, max.	16 A
Response time	≤ 150 ns
Protection level on output side sym., input 8/20 μs, typ.	600 V
Protection level on output side unsym., input 8/20 μs, typ.	1500 V
Leakage current at U <sub>n</sub>	1 μA
Optical function indicator	green LED = OK; red LED = fault
Pollution severity	2

Rated voltage (AC)	230 V
max. continuous voltage, U <sub>c</sub> (AC)	275 V
Operating current, I <sub>max</sub> to DIN VDE 0675-6	16 A
Requirements class to IEC 61643-1	Requirements class D
Combined pulse U <sub>oc</sub>	Class III
	4 kV
Discharge current, max. (8/20 μs)	5 kA
Fuse, max.	16 A
Response time	≤ 150 ns
Protection level on output side sym., input 8/20 μs, typ.	600 V
Protection level on output side unsym., input 8/20 μs, typ.	1500 V
Leakage current at U <sub>n</sub>	1 μA
Optical function indicator	green LED = OK; red LED = fault
Pollution severity	2

Rated voltage (AC)	230 V
max. continuous voltage, U <sub>c</sub> (AC)	275 V
Operating current, I <sub>max</sub> to DIN VDE 0675-6	16 A
Requirements class to IEC 61643-1	Requirements class D
Combined pulse U <sub>oc</sub>	Class III
	4 kV
Discharge current, max. (8/20 μs)	5 kA
Fuse, max.	16 A
Response time	≤ 150 ns
Protection level on output side sym., input 8/20 μs, typ.	600 V
Protection level on output side unsym., input 8/20 μs, typ.	1500 V
Leakage current at U <sub>n</sub>	1 μA
Optical function indicator	green LED = OK; red LED = fault
Pollution severity	2

Surge category	III
Ambient temperature (operational)	0 ... 60°C
Storage temperature	-25 ... 85°C

Surge category	III
Ambient temperature (operational)	0 ... 60°C
Storage temperature	-25 ... 85°C

Surge category	III
Ambient temperature (operational)	0 ... 60°C
Storage temperature	-25 ... 85°C

**General data**

Input voltage, max.	190 V DC
Rated current I <sub>n</sub> , max.	0.45 A
Standard signal	Analogue telephone signal RJ45/RJ11/12
Rated discharge current (8/20 μs)	4 kA
Total current	10 A
Response time, typical	< 5 ns
Resistance per path	1.1 Ω
Cut-off frequency f <sub>g</sub> 600 Ω system	2 MHz
Transistor output, positive-switching	
Residual voltage at output for input pulse of 1 kV/μs	a/b ≤ 270V a-b/PE ≤ 270V
Residual voltage at output for 8/20μs and input pulse of 5kA	a/b ≤ 100V a-b/PE ≤ 100V

Input voltage, max.	190 V DC
Rated current I <sub>n</sub> , max.	0.45 A
Standard signal	Analogue telephone signal RJ45/RJ11/12
Rated discharge current (8/20 μs)	4 kA
Total current	10 A
Response time, typical	< 5 ns
Resistance per path	1.1 Ω
Cut-off frequency f <sub>g</sub> 600 Ω system	2 MHz
Transistor output, positive-switching	
Residual voltage at output for input pulse of 1 kV/μs	a/b ≤ 270V a-b/PE ≤ 270V
Residual voltage at output for 8/20μs and input pulse of 5kA	a/b ≤ 100V a-b/PE ≤ 100V

Input voltage, max.	30 V
Rated current I <sub>n</sub> , max.	0.2 A
Standard signal	Ethernet Cat.5 + Cat.6
Rated discharge current (8/20 μs)	2500 A
Total current	10 kA (8/20μs)
Response time, typical	< 5 ns
Resistance per path	
Cut-off frequency f <sub>g</sub> 600 Ω system	
Transistor output, positive-switching	
Residual voltage at output for input pulse of 1 kV/μs	Cable / Cable ≤ 80 V; Cable / PE ≤ 300 V
Residual voltage at output for 8/20μs and input pulse of 5kA	Cable / Cable ≤ 130 V; Cable / PE ≤ 600 V

**Dimensions**

Clamping range (rating- / min. / max.)	mm <sup>2</sup>
Length x width x height	mm

**Schuko**

Length x width x height	110 x 62 x 48
-------------------------	---------------

**Schuko**

Length of Cat.6 cable: 0.75 m + 2.20 m	
--	--

**Note**

Including Cable, RJ 11/12 both ends

Length of Cat.6 cable: 0.75 m + 2.20 m

**Ordering data**

Version	without telecomm. contact
---------	---------------------------

Type	Qty.	Order No.
PU D ZS 230V- 16A/ analog a/b	1	on demand

Type	Qty.	Order No.
PU D ZS CAT.6	1	on demand

**Note**

**Accessories**

Note: Conductor, RJ45 on both sides, order No. 8697590000



Surge protection for  
low-voltage supplies

C



## Surge protection mains filter

### WAVEFILTERS for simple radio interference suppression in the control cabinet

The WAVEFILTER series eliminates the time-consuming work of screwing in mains filters. These filters are simply clipped on to the TS35 rail and connected to the device requiring suppression. The two-stage WAVEFILTER with overall width 22.5 mm in 1 A, 3 A, 6 A and 10 A versions offers high attenuation.

The WAVEFILTER with current-compensating choke is ideal for applications in drive technology and control/automation systems, e.g. for suppressing continuous interference types such as "noise" or "ripple" caused by interfering radiation from other systems, or interference from frequency converters and switch-mode power supplies. A short, low-ohm mass connection is required for the WAVEFILTER to function perfectly. We recommend earthing all devices directly with the largest possible cross-section to a central earthing point in the control cabinet.

### Interference signals

We distinguish between two types of induced transient and continuous interference signals: symmetrical (differential mode) and asymmetrical (common mode). The symmetrical interference signals generate a voltage between the signal leads of the system. The asymmetrical interference voltages occur between the signal leads and earth.

The WAVEFILTER is suitable for attenuating both kinds of interference signal. In addition, WAVEFILTER 10 A also has an earthing conductor choke. This earthing conductor choke supports both attenuation on the earthing conductor for the filter and additional attenuation of asymmetrical interference voltages.

The WAVEFILTER have cULus approval.

### Insertion loss

#### 1 A WAVEFILTER

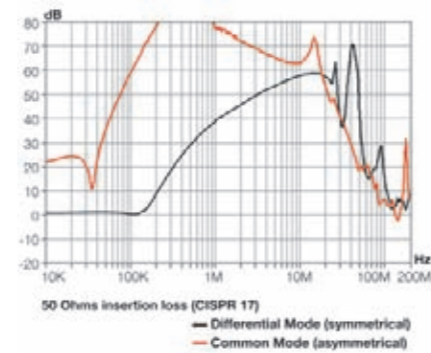

#### 3 A WAVEFILTER

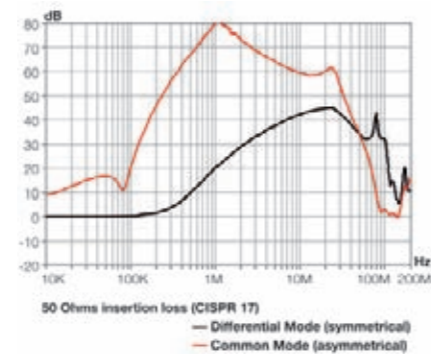

#### 6 A WAVEFILTER

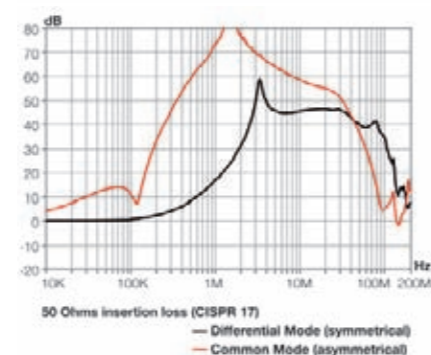

#### 10 A WAVEFILTER

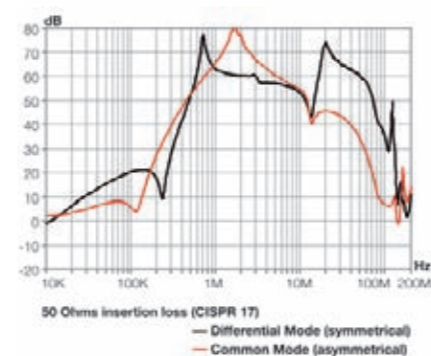

Mains filter

Surge protection for  
low-voltage supplies

Installation height 112.4 mm



Installation height 92.4 mm



C



Dimensions

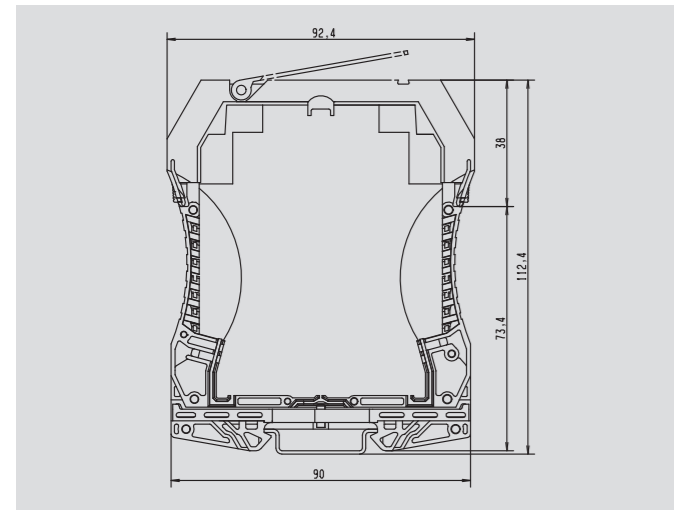

Dimensions

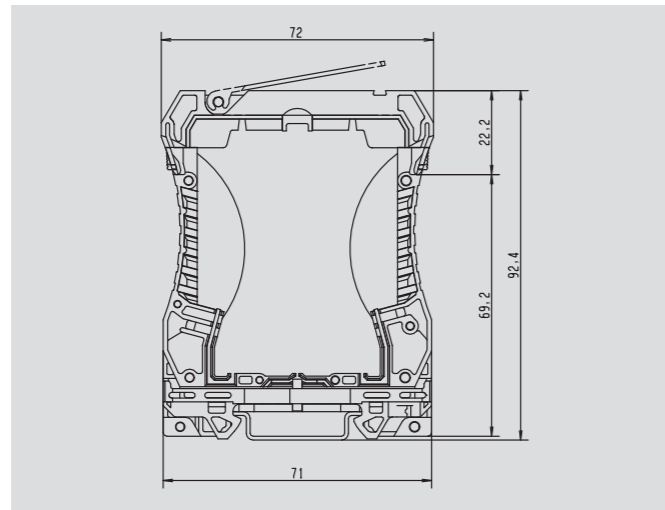

**Mains filter**

**mains filter**



**WAVEFILTER 1 A 250 V**

**WAVEFILTER 3 A 250 V**

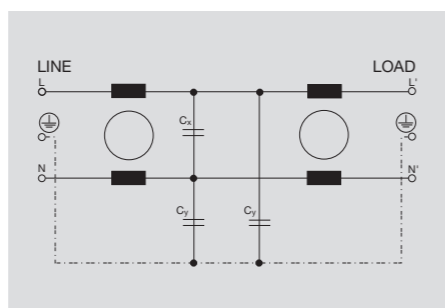
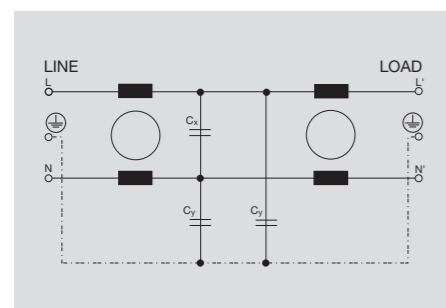

**Technical data**

Technical data	WAVEFILTER 1 A 250 V	WAVEFILTER 3 A 250 V
Rated voltage (AC/DC)	250 V	250 V
Rated current	1 A	3 A
Capacitance	C <sub>v</sub> / C <sub>z</sub> : 33nF	C <sub>v</sub> / C <sub>z</sub> : 33nF
Inductance L and L1	10.00 mH	2.00 mH
Leakage current at Un	190 µA	190 µA
Test voltage P/N-PE	2000.00 V AC	2000.00 V AC
Test voltage P-N	1700.00 V DC	1700.00 V DC
Ambient temperature (operational)	-20 ... 40°C	-20 ... 40°C
Approvals	cURus	cURus

**Dimensions**

Dimensions	WAVEFILTER 1 A 250 V	WAVEFILTER 3 A 250 V
Clamping range (rating- / min. / max.)	2.5 / 0.5 / 2.5	2.5 / 0.5 / 2.5
Length x width x height	90 x 22.5 x 73.4	90 x 22.5 x 73.4
Note	See attenuation curve	See attenuation curve

**Ordering data**

Version	Type	Qty.	Order No.
	WAVEFILTER 1A	1	8614790000
	WAVEFILTER 3A	1	8614780000

Note

**Accessories**

Note

mains filter

WAVEFILTER 6 A 250 V

WAVEFILTER 10 A 250 V

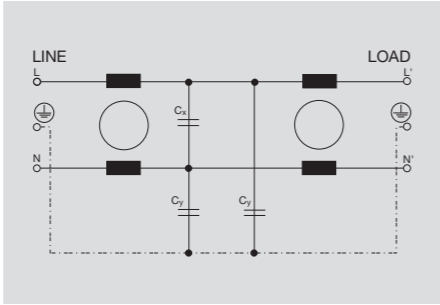
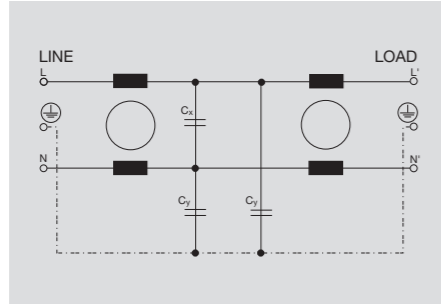
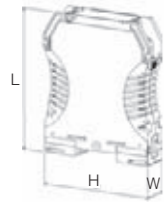

Surge protection for low-voltage supplies

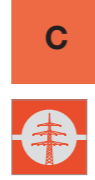

Technical data

Technical data	WAVEFILTER 6 A 250 V	WAVEFILTER 10 A 250 V
Rated voltage (AC/DC)	250 V	250 V
Rated current	6 A	10 A
Capacitance	C <sub>1</sub> : 33 nF / C <sub>2</sub> : 22 nF	C <sub>1</sub> : 470 nF / C <sub>2</sub> : 4,7 nF
Inductance L and L1	0.80 mH	0.80 mH
Leakage current at U <sub>n</sub>	190 µA	190 µA
Test voltage P/N-PE	2000.00 V AC	2000.00 V AC
Test voltage P-N	1700.00 V DC	1700.00 V DC
Ambient temperature (operational)	-20 ... 40°C	-20 ... 40°C
Approvals	cURus	cURus

Dimensions

Dimensions	WAVEFILTER 6 A 250 V	WAVEFILTER 10 A 250 V
Clamping range (rating- / min. / max.)	2.5 / 0.5 / 2.5 mm <sup>2</sup>	2.5 / 0.5 / 2.5 mm <sup>2</sup>
Length x width x height	90 x 22.5 x 73.4 mm	90 x 22.5 x 73.4 mm

Note: See attenuation curve

Ordering data

Version	Type	Qty.	Order No.
	WAVEFILTER 6A	1	8614800000
	WAVEFILTER 10A	1	8614770000

Note

Accessories

Note

# Installation specification for Weidmüller PU I- and PU II-Surge protection in power supply networks

The surge protection device may only be installed by a qualified technician. Make sure you take account of your national connection conditions when installing.

## 2. Installation specifications

### 2.1 Place of installation

The PU II must be installed in the meter cabinet or in a distributing cabinet in such a way that the terminal space is inaccessible to unauthorised persons. The PU I and the PU BC is installed close to the feed in order to establish the necessary lightning protection equipotential bonding between the lightning protection system and the power distribution board. All arresters must be installed by a qualified electrician. The installation of systems with surge protection devices is described in VDE 0100 part 534 (Apr 1999) "Selection and erection of equipment". This pre-standard is related to the following standards:

#### 1. IEC 60364-4-43

"Protection against overvoltage resulting from atmospheric conditions and switching activities"

#### 2. IEC60364-5-53

"Selection and installation of electrical equipment"

#### 3. IEC 61024-1

"Protection of buildings against lightning strike"

#### 4. IEC 61312-1

"Protection against electromagnetic lightning impulse"

## 1. Use

The PU II surge protection devices of class II (class C ) are for protecting low-voltage consumer installations and electronic devices from voltage surges arising through atmospheric discharge (lightning) or switching activities. The PU II conforms to VDE 0675, part 6, class C (Dec 2002), IEC 61643-1 (03/2005), and ÖVE SN 60 part 4 and part 1. The voltage limiting function is performed by high-power metal oxide varistors.

The PU I and the PU BC are lightning arresters in Class I/II (Class B/C), according to DIN VDE 0675, T.6 (11/89) and the IEC61643-1 03/2005, ENV 61024-1 (1/95) and the IEC 1312-1 (2/95). Integrated varistors guarantee the necessary equipotential bonding in the event of lightning strikes (lightning protection equipotential bonding in accordance with DIN VDE 0185, part 1 (Nov 1982)) between the building lightning protection system and the earthing system of the power supply.

The PU III and PU D surge protection devices of class III (class D) protect low-voltage consumer installations and electronic devices from voltage surges and switching activities. The PU III and PU D are also installed after the PU C in small/storey distribution boards. The PU III and PU D satisfy the requirements of DIN VDE 0675, part 6, class C (Nov 1989), draft, DIN VDE 0675, part 6, A2 (Oct 1996) and IEC61643-1 (03/2005).

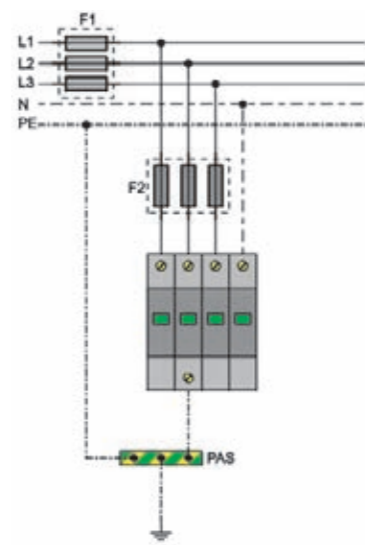

### 2.2 Electrical connection

The lightning arrester PU I/PU BC and the PU II surge protection should be connected with the shortest possible lines between the outer wires (L1, L2, L3) or the neutral wire (N) and the earth (PE)





on the consumer installation. Ensure that unprotected conductors are not run parallel to protected wires (connection examples can be found on the fold-out of the last cover page).

**2.2.1 Connection to the phase conductors and neutral conductor**

For the connecting cables to the PU I, PU II, or PU BC arresters, normally the same conductor cross-section is used both for the outer wires (L1, L2, L3) and the neutral wire (N). In the event of a reduction of the cross-section, a protective device (e.g. main terminal fuse) must be provided for short-circuit protection of the connecting lines. The arrester terminals must not be used as tee-off terminals. The back-up fuse for the PU II can be selected up to 125 A gL. For the PU I and the PU BC, up to 160 A gL can be selected. Serially-connected residual current devices (RCDs) of type S (3 kA, 8/20 µs) must be resistant against surge currents.

**Notes:**

In the TN-CS system, 3-pole PU II devices are used. If the PEN conductor is run individually as PE and N, a 4-pole PU II must be used. According to DIN VDE 0100-534/A1 (Oct 1996), it is permissible in a TT system to install a PU II 3+1 280 V protection device. In the IT system with 400 V phase conductors, the PU II 3+1 385 V is installed for 385 V.

**2.2.2 Installation of D arresters**

The PU III and PU D arrester are installed in a similar way to the PU II. The PU III and PU D are integrated into the line to be protected and can protect electrical circuits of up to 16 A. Installation can be done in consumer units for a electrical circuit that protects, for example, monitors. The PO DS is suitable for local installation in devices or in cable ducts.

**2.2.3 Connecting to earth**

The arrester's earthing conductor must be connected by the shortest possible route (≤ 0.5m) to the earthing terminal of the consumer installation. Longer connection lines reduce the efficiency of the surge protection. Parallel routing with other electrical lines must be avoided. In electrical consumer installations with equipotential bonding, the earthed equipotential bonding strip can be used as connection point (see page A.18 Low-voltage power supply, principles). It must always be ensured that the arrester earth is connected

to the earth of the consumer installation. For TN systems, the PEN conductor and the earthing conductor of the arrester must be connected to each other. The PEN conductor of the electricity supply company must not be used as an earth electrode. Where the PE rail or PEN rail of a distribution board is used as an earthing terminal, these rails must be connected to the earth electrode of the consumer installation via a separate earthing conductor.

Two earthing terminals are provided on the PU BC. Both terminals must be used. One goes to the equipotential bonding terminal of the building, the other to the PE conductor of the installation. The cross-section of the earthing conductor of the arrester to the main equipotential bonding conductor is determined in accordance with Table 1, as for the phase conductors. This must be at least 0.5 x cross-section of the main protective conductor, although 25 mm<sup>2</sup> Cu is defined as the upper limit. 10 mm<sup>2</sup> Cu is required as the lower limit.

Earth line	Cross-section mm <sup>2</sup>		
Main protective conductor – coming from current source or protective conductor leaving – incoming service box or – main distribution board	≤ 16	25	≤ 35
Phase conductor	≤ 35	50	≥ 70
Earth line of arrester	10	26	25

Table 1

**3. Functional check**

PU surge protection devices and lightning arresters must be subjected to a visual check especially during periods of thunderstorms. If the colour of the sight window changes or the LED is red, the surge protection device must be replaced. Varistors can exhibit high temperatures as a result of ageing. In low-voltage systems, this can result in fire. The integrated temperature monitoring device therefore automatically disconnects the varistor from the power supply in the event of danger. On the PU III or PO DS, this disconnection is indicated by the warning lamp/LED being extinguished. PU III and PU DS devices have an additional switching contact that indicates this disconnection. The back-up fuses you install depend on the conductor cross-section and type of routing. For the PU D arrester, the back-up fuse rating is 16 A.

**Installation specification****3.1 Replacement**

When an arrester shows a red sight window or the red LED is lit as mentioned in point 3, the arrester must be replaced by a qualified electrician. The individual class I and II arresters are of plug-in type and coded according to their voltage rating. When testing insulation resistance in accordance with DIN VDE 0100 part 610, varistor-type arresters must be removed – by pulling off the top section, for example. The correct arrester for the rated voltage of the system must be re-installed.

**4. Connecting the remote signalling modules****4.1 Remote signalling (R) with monitoring modules of type PU I R, PU II R, PUBCR, PU III or PU D**

The signal contact is designed as a change-over (CO) contact. It is connected to terminals 11 and 14. In normal operation (green flag) terminals 11 and 12 are closed. In this situation terminals 11/14 are open. In the event of a malfunction (red flag), terminals 11/14 are closed and terminals 11/12 are open. On the PU III and PU D, the responding of the disconnection device is indicated by the opening of a non-reversible thermal release. The signalling circuit is connected with stranded conductors (e.g. NYM); parallel routing of the conductors with the supply and earthing conductors must be avoided. Replacing a suppressor circuit with an overvoltage fine protection appropriate for the voltage level reduces interference in and around the analysing unit.

**4.2 Approvals**

The PU I and PU II series has been issued a CB report and can therefore be transferred to country-specific approvals. The PU I and PU II devices are provided with the CE mark.

**Accessories**

The LogiMark system marker (order no. 1751841687) with the text “**Caution!** System is protected with surge arresters” is available as an accessory.

**1. Application**

According to the requirements of class I (DIN VDE 0675 part 6 (draft Nov 1989)/A1 Mar 1996) and class I in accordance with IEC 61643-1 (Feb 1998), the arrester is for lightning protection equipotential bonding at the junction of interface 0 to 1 (as per IEC 1312-1).

In TN, TT and IT systems, combinations of several surge arresters are frequently used as N-PE arresters. In networks rated for a short-circuit current of 500 A, the PU 1 TSG 50 kA / 1.5 kV-260 V can be used in a combination circuit as 50 kA sparkover gap between L and N. The use of a non-blowout sparkover gap satisfies the inspection requirements for surge protection devices of class B from the VDEW (Association of German Power Stations) directive (1st edition 1998).

**2. Backup fuse**

The PU I series and PU II series surge protection devices have a passive behaviour during normal operations. No current is consumed. The necessary protection against short-circuits and overloads is thus provided by a fuse designed for the type of installation and the cross-section of the connecting lines. In addition, the products of the PU series are tested with a maximum backup fuse (refer to technical data for details).

If the fuse used in the system has a smaller or equal value (for PU I  $\leq 160$  A , for PU II  $\leq 125$  A), then it can be used for line protection on the power supply. However, if the fuse is larger than that given in the technical specification, additional fuses to suit the connecting line must be incorporated in the line to the PU module.

## 2.2 Application

PU 1 TSG (+) modules provide the necessary lightning protection equipotential bonding for existing lightning protection systems and incoming supplies.

Enclosed PU 1 TSG modules are preferably installed in the distribution boards of the building's electrical installation.

Unenclosed PU 1 TSG+ modules with voltages of 330 or 440 V are frequently installed in industrial applications.

C



## 3. Maintenance

According to their applications, PU 1 TSG(+) modules are designed for high electrical mechanical loads. Faulty arresters must be replaced immediately. The arresters may not be opened.

**Installation specification for PU 1 TSG(+) surge protection in power supply networks. May only be installed by qualified personnel. During the installation, please observe the connection conditions specific to the country of application.**



# Surge protection for instrumentation and control equipment

<b>Surge protection for instrumentation and control equipment</b>	Quick selection guide	D.2
	Surge protection for instrumentation and control equipment	D.4
	MC series	D.6
	DK series	D.19
	EG series	D.28
	JACKPAC®	D.32
	RS series	D.36
	LPU series (plug-in)	D.40
	Surge protection for instrumentation and control equipment with ATEX approval	D.48
	Earthing of shielded lines	D.56
	Installation advice for instrumentation and control engineering	D.58
	Applications in instrumentation and control engineering	D.59



## Quick selection guide

## Product quick selection, information technology

## Instrumentation and control equipment

Interface/ signal	Mounting	Connection system	Protected wires	Discharge capacity	Operating current	Max. voltage	Protection device	Order No.
0-20 mA, 4-20 mA	on DIN rail,separable	screw terminals	2	6 kA	100 mA	24V-230 V	LPU 24 V-230 V 100 mA	<b>800830000-8008380000 + 8007871001</b>
0-20 mA, 4-20 mA	on DIN rail,separable	screw terminals	2	6 kA	1.5 A	24V-230 V	LPU 24 V-230 V 1.5 A	<b>8008430000-8008460000 + 8007871001</b>
0-20 mA, 4-20 mA	on DIN rail,compact	screw terminals	1	5 kA	300 mA	24V-230 V	DKU 24-230 V 0.3 A	<b>8015800000-8019330000</b>
0-20 mA, 4-20 mA	on DIN rail,compact	screw terminals	2	5-7 kA	0.3-1 A	24V-230 V	DKU DK5/DK6 24 V-230 V	<b>8238340000-8263760000</b>
0-20 mA, 4-20 mA	on DIN rail,compact	tension clamp terminals	2	5 kA	500 mA	24V-230 V	MCZ OVP 24 V-230 V	<b>8448920000-8449080000</b>
Binary signals	on DIN rail,separable	screw terminals	2	6 kA	100 mA	24V-230 V	LPU 24 V - 230 V SL	<b>8008230000-8008280000 + 8007871001</b>
Binary signals	on DIN rail,compact	screw terminals	1	5 kA	300 mA	24V-230 V	DKU 24-230 V 0.3 A	<b>8015800000-8019330000</b>
Binary signals	on DIN rail,compact	tension clamp terminals	2	5 kA	500 mA	24V-230 V	MCZ OVP SL 24 V-230 V	<b>8448940000-8449090000</b>
PT 100, PT 1000	on DIN rail,separable	screw terminals	2	6 kA	100 mA	24V	LPU 24 V 100 mA SL	<b>8008230000+8007871001</b>
PT 100, PT 1000	on DIN rail,compact	tension clamp terminals	2	5 kA	1.25 A	24V	MCZ OVP SL 24 V1.25 A	<b>8448970000</b>
TTL	on DIN rail,separable	screw terminals	2	6 kA	100 mA	24V	LPU 24 V 100 mA SL	<b>8008230000+8007871001</b>
TTL	on DIN rail,compact	tension clamp terminals	2	5 kA	0.5 A	24V	MCZ OVP SL 24 V 0.5 A	<b>8448940000</b>
TTY	on DIN rail,separable	screw terminals	2	6 kA	100 mA	24V	LPU 24 V 100 mA SL	<b>8008230000+8007871001</b>
TTY	on DIN rail,compact	tension clamp terminals	2	5 kA	0.5 A	24V	MCZ OVP SL 24 V 0.5 A	<b>8448940000</b>
RS 232	on DIN rail,separable	screw terminals	2	6 kA	100 mA	24V	LPU 24 V 100 mA SL	<b>8008230000+8007871001</b>
RS 232	on DIN rail,compact	tension clamp terminals	2	5 kA	0.5 A	24V	MCZ OVP SL 24 V 0.5 A	<b>8448940000</b>
RS 232	adapter plug	D-Sub	8	0.5 kA	15V	RS232	adapter plug	<b>8570500000 or 8570510000</b>
RS 232	built-in housing	screw terminals	2	5 kA	15V	EGU4	RS232	<b>1170460000</b>
RS 485	on DIN rail,separable	screw terminals	2	6 kA	100 mA	24V	LPU 24 V 100 mA SL	<b>8008230000+8007871001</b>
RS 485	on DIN rail,compact	tension clamp terminals	2	5 kA	0.5 A	24V	MCZ OVP SL 24 V 0.5 A	<b>8448940000</b>
RS 485	built-in housing	screw terminals	4	0.5 kA	12V	RS485/RS422	K21	<b>8008501001</b>
RS 422, V11	on DIN rail,separable	screw terminals	2	6 kA	100 mA	24V	LPU 24 V 100 mA SL	<b>8008230000+8007871001</b>
RS 422, V11	on DIN rail,compact	tension clamp terminals	2	5 kA	0.5 A	24V	MCZ OVP SL 24 V 0.5 A	<b>8448940000</b>

## Bus systems

Interface/ signal	Mounting	Connection system	Protected wires	Discharge capacity	Operating current	Max. voltage	Protection device	Order No.
ASI	on DIN rail,separable	screw terminals	2	6 kA			PU DS 48 V (yellow cable)	<b>8670740000</b>
ASI	on DIN rail,separable	screw terminals	2	6 kA			PU DS 24 V 8 V (black cable)	<b>8682100000</b>
Bitbus	on DIN rail,separable	screw terminals	2	6 kA			RS 485	<b>9454930000+8007871001</b>
CAN Bus	on DIN rail,separable	screw terminals	2	6 kA			RS 485	<b>9454930000+8007871001</b>
CANopen	on DIN rail,compact	tension clamp terminals	2	5 kA	0.3 A	12 V	MCZ OVP HF 12 V 0.3 A	<b>8948610000</b>
C-Bus (Honeywell)	on DIN rail,compact	tension clamp terminals	2	5 kA	0.3 A	5 V	MCZ OVP HF 5 V 0.3 A	<b>8948620000</b>
DATEx P	on DIN rail,compact	tension clamp terminals	2	5 kA	0.3 A	24 V	MCZ OVP HF 24 V 0.3 A	<b>8948600000</b>
Device Net	on DIN rail,separable	screw terminals	2	6 kA	1.5A	12 V	RS 485	<b>9454930000+8007871001</b>
Device Net	on DIN rail,compact	tension clamp terminals	2	5 kA	0.3 A	12 V	MCZ OVP HF 12 V 0.3 A	<b>8948610000</b>
Ethernet Cat 5	plug-in adapter	RJ 45 connection	4	2 kA		7 V	DME 100Tx-4RJ	<b>8738780000</b>
Ethernet Cat 5	plug-in adapter on DIN rail	RJ 45 connection	4	2 kA		7 V	DME 100Tx-4RJ TS 35	<b>8830230000</b>
Ethernet Cat 5	adapter plug	M12	4	10 kA		30 V	JACKPAC® Ethernet Cat.5 M12	<b>8805570000</b>
Ethernet Cat 6	combination adapter	RJ 45 connection	4	5 kA		30 V	PU D ZS 230 V16 A Cat.6	<b>8805530000</b>
Ethernet Cat 6	adapter plug	RJ 45 connection	4	10 kA		48 V	JACKPAC® Ethernet Cat.6 IP20	<b>8805550000</b>
Ethernet Cat 6	adapter plug	RJ 45 connection	4	10 kA		48 V	JACKPAC® Ethernet Cat.6 IP67	<b>8805560000</b>
ET200	on DIN rail,compact	tension clamp terminals	2	5 kA	0.3 A	5 V	MCZ OVP HF 5 V 0.3 A	<b>8948620000</b>
HDSL	on DIN rail,compact	tension clamp terminals	2	5 kA	0.3 A	24 V	MCZ OVP HF 24 V 0.3 A	<b>8948600000</b>
Interbus	on DIN rail,compact	tension clamp terminals	2	5 kA	0.3 A	5 V	MCZ OVP HF 5 V 0.3 A	<b>8948620000</b>
Interbus-inline I/O	on DIN rail,separable	screw terminals	2	6 kA		53 V	LPU 48 V 1.5 A	<b>8008440000+8007871001</b>
Interbus-inline I/O	on DIN rail,compact	tension clamp terminals	2	10 kA	1.25A	53 V	MCZ OVP CL 48 V 1.25 A	<b>8449040000</b>
LON-Bus	on DIN rail,compact	tension clamp terminals	2	5 kA	0.3 A	12 V	MCZ OVP HF 12 V 0.3 A	<b>8948610000</b>
LON TP/XF 78	on DIN rail,separable	screw terminals	2	6 kA	1.5A	27 V	LPU 24 V 1.5 A	<b>8008430000+8007871001</b>
LON TP/XF 78	on DIN rail,compact	tension clamp terminals	2	10 kA	0.5A	28 V	MCZ OVP CL 24 V 0.5 A	<b>8448920000</b>
LON TP/XF 78	on DIN rail,compact	tension clamp terminals	2	0.1kA	16A	14 V	MCZ OVP LON bus	<b>8473470000</b>
M-Bus	on DIN rail,compact	tension clamp terminals	2	5 kA	0.3 A	24 V	MCZ OVP HF 24 V 0.3 A	<b>8948600000</b>
MOD-Bus	on DIN rail,compact	tension clamp terminals	2	5 kA	0.3 A	5 V	MCZ OVP HF 5 V 0.3 A	<b>8948620000</b>
Profibus	on DIN rail,compact	tension clamp terminals	2	5 kA	0.3 A	5 V	MCZ OVP HF 5 V 0.3 A	<b>8948620000</b>
Profibus DP/FMS	on DIN rail,separable	screw terminals	2	6 kA	1.5A	12 V	RS 485	<b>9454930000+8007871001</b>
Profibus PA	on DIN rail,separable	screw terminals	2	6 kA		53 V	LPU 48 V 1.5 A	<b>8008440000+8007871001</b>

**Bus systems**

Interface/signal	Mounting	Connection system	Protected wires	Discharge capacity	Operating current	Max. voltage	Protection device	Order No.
				<b>8/20 µs</b>	<b>I<sub>max</sub></b>	<b>DC</b>		
Profibus PA	on DIN rail,compact	tension clamp terminals	2	10 kA	1.25 A	53 V	MCZ OVP CL 48 V 1.25 A	<b>8449040000</b>
Profinet	on DIN rail,compact	tension clamp terminals	2	5 kA	0.3 A	5 V	MCZ OVP HF 5 V 0.3 A	<b>8948620000</b>
Sinec L2	on DIN rail,compact	tension clamp terminals	2	5 kA	0.3 A	5 V	MCZ OVP HF 5 V 0.3 A	<b>8948620000</b>
Sinec L2 DP/ --Profibus DP	on DIN rail,separable	screw terminals	2	6 kA	1.5 A	12 V	RS 485	<b>9454930000+8007871001</b>
TCP / IP	on DIN rail,compact	tension clamp terminals	2	5 kA	0.3 A	5 V	MCZ OVP HF 5 V 0.3 A	<b>8948620000</b>
Termination	on DIN rail,compact	screw terminals	2			60 V	Dialoc bus terminator	<b>8496110000</b>
Token Ring	on DIN rail,compact	tension clamp terminals	2	0.5kA	16 A	27 V	MCZ OVP TAZ 24 V	<b>8449160000</b>
Token Ring	on DIN rail,compact	tension clamp terminals	2	5 kA	0.3 A	5 V	MCZ OVP HF 5 V 0.3 A	<b>8948620000</b>
TP/FTT 10+TP/LPT10	on DIN rail,separable	screw terminals	2	6 kA		53 V	LPU 48 V 1.5 A	<b>8008440000+8007871001</b>
TP/FTT 10+TP/LPT10	on DIN rail,compact	tension clamp terminals	2	10 kA	1.25 A	53 V	MCZ OVP CL 48 V 1.25 A	<b>8449040000</b>



**Telecommunication**

Interface/signal	Mounting	Connection system	Protected wires	Discharge capacity	Operating current	Max. voltage	Protection device	Order No.
				<b>8/20 µs</b>	<b>I<sub>max</sub></b>	<b>DC</b>		
ADSL,T-DSL	on DIN rail,compact	screw terminals	2	20 kA		135 V	Dk4/35 U gas discharge tube 230 V	<b>9400120000</b>
ADSL,T-DSL	adapter plug	RJ 45	2	5 kA		190 V	PU D ZS UK0	<b>8697570000</b>
ISDN (S0)	in installation boxes	TAE	2	4 kA		190 V	TAE OVP ISDN	<b>8674000000</b>
ISDN (S0)	in installation boxes	TAE	2	4 kA		190 V	TAE OVP ISDN LED	<b>8674010000</b>
ISDN (S0)	in installation boxes	TAE	2	4 kA		190 V	TAE OVP ISDN FM	<b>8673970000</b>
ISDN (S0)	adapter plug	RJ 45	4	4 kA		190 V	PU D ZS S0	<b>8697560000</b>
ISDN (UK0)	on DIN rail,compact	screw terminals	2	20 kA		135 V	Dk4/35 U gas discharge tube 230 V	<b>9400120000</b>
ISDN (UK0)	adapter plug	RJ 45	2	4 kA		190 V	PU D ZS UK0	<b>8697570000</b>
ISDN (UK0)	in installation boxes	TAE	2	4 kA		190 V	TAE OVP ISDN	<b>8674000000</b>
ISDN (UK0)	in installation boxes	TAE	2	4 kA		190 V	TAE OVP ISDN LED	<b>8674010000</b>
ISDN (UK0)	in installation boxes	TAE	2	4 kA		190 V	TAE OVP ISDN FM	<b>8673970000</b>
Telephone analogue	in installation boxes	TAE	2	4 kA		190 V	TAE OVP analogue	<b>8673980000</b>
Telephone analogue	in installation boxes	TAE	2	4 kA		190 V	TAE OVP analogue LED	<b>8674020000</b>
Telephone analogue	in installation boxes	TAE	2	4 kA		190 V	TAE OVP analogue FM	<b>8649910000</b>



**Power supplies**

Interface/signal	Mounting	Connection system	Protected wires	Discharge capacity	Operating current	Max. voltage	Protection device	Order No.
				<b>8/20 µs</b>	<b>I<sub>max</sub></b>	<b>DC</b>		
24 V 6 A	clip-on base profiles	screw terminals	2	24 kA	6 A	27 V	RSU 24 V 6 A	<b>1171361001</b>
115 V 6 A	clip-on base profiles	screw terminals	2	24 kA	6 A	130 V	RSU 115 V 6 A	<b>1171561001</b>
230 V 6 A	clip-on base profiles	screw terminals	2	24 kA	6 A	250 V	RSU 230 V 6 A	<b>1171661001</b>
24 V 10 A	clip-on base profiles	screw terminals	2	24 kA	10 A	27 V	RSU 24 V 10 A	<b>8104201001</b>
115 V 10 A	clip-on base profiles	screw terminals	2	24 kA	10 A	130 V	RSU 115 V 10 A	<b>8104221001</b>
230 V 10 A	clip-on base profiles	screw terminals	2	24 kA	10 A	250 V	RSU 230 V 10 A	<b>8093281001</b>

**TV/radio**

Interface/signal	Mounting	Connection system	Protected wires	Discharge capacity	Operating current	Max. voltage	Protection device	Order No.
				<b>8/20 µs</b>	<b>I<sub>max</sub></b>	<b>DC</b>		
TV/radio	adapter plug	BNC	2	5 kA	16 A	70 V	PU D ZS TV/R	<b>8779230000</b>

# Surge protection for instrumentation and control equipment

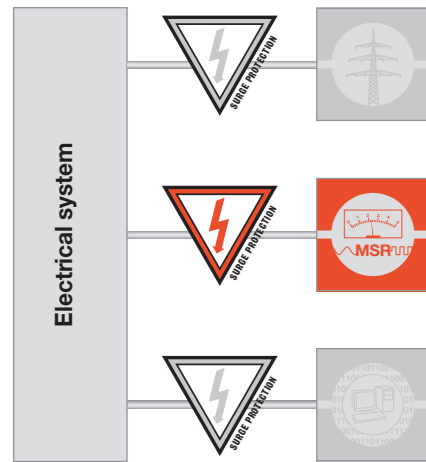

important areas in which breakdowns or malfunctions can lead to high costs. As the standards covering the low control voltages do not specify many parameters, the use of surge protection, apart from lightning protection zoning concepts, has to be classified according to type of signal, application circuit and the anticipated interference voltage phenomena.

## Types of interference voltage

The transient surges coupled into a system via one or more coupling mechanisms occur as normal- or common-mode interference. These are measured as longitudinal or transverse voltages and, depending on the circuit, designated as symmetrical or asymmetrical voltages. (For further information see the “Principles” chapter.)

## Basic classification

The current scope of automation technology results in a wide range of applications for surge protection in the field of instrumentation and control engineering. Of course, one important prerequisite is the consistent use of coordinated surge protection in all sections of the plant or building. In industry, instrumentation and control systems are

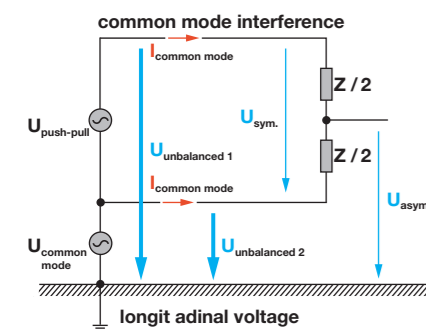

Common-mode interference (asymmetrical interference):  
Common-mode voltage between conductor and reference potential. (earth) / Mainly caused by capacitive coupling (electrical field)

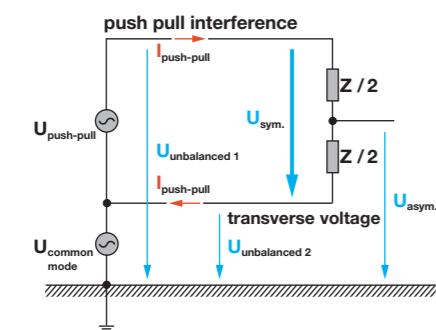

Normal-mode interference (symmetrical interference):  
Normal-mode voltage between supply and return conductor Load and interference source connected in series, e.g. inductive (magnetic field) or conductive coupling (common impedance)

## Types of signal

### Binary signals $\triangleq$ (symmetrical Loop)

These are two-wire signals with a common reference potential which are required by, for example, switches, PLC switch outputs, photoelectric barriers, position sensors, solenoid valves, warning lamps, PLC inputs, etc. Normally, these signals have a common reference potential that can be either connected or not connected to earth potential depending on the type of protection. The coupled transient interference is primarily common-mode interference.

### Analogue signals $\triangleq$ (current Loop)

Measuring circuits are normally designed as two-wire current loops or voltage signals without a common reference potential, like the 0(4)...20 mA current loop. The coupled transient interference is primarily normal-mode interference. For temperature measurements with the PT100 measuring shunt in the three-wire version, the voltage drop at the shunt is measured via the third wire. This must be included in the system of protection. The PT100 measuring shunt is also available in a four-wire version in which the voltage drop at the shunt is measured via the two additional lines without additional line losses in the PT100 measuring circuit. The coupled transient normal-mode interference occurs between the various wires.



Class III, Varistor



Binary signals

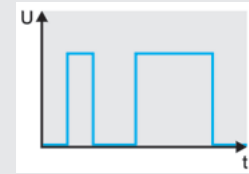

Two-wire, usually with common reference potential, e.g. signals from binary sensors, actuators and indicators such as limit switches, probes, position sensors, photoelectric barriers, contactors, solenoid valves, warning lamps.

Protection for binary signals connected to earth potential

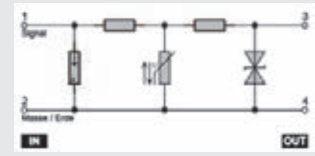

Protection for binary signals not connected to earth potential

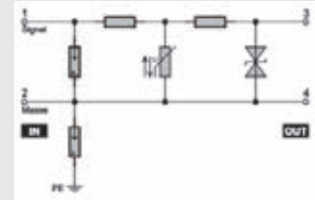

Type

- MCZ OVP HF for high-frequency data signals **Page D.7**
- MCZ OVP symm., 2 signal paths **Page D.9**
- MCZ OVP GDT, MOV, TAZ, 1 signal path **Page D.17**
- DKU, 1 signal path **Page D.20**
- DK4U **Page D.24**
- EGU 1, 1 signal path **Page D.29**
- EGU 2, 1 signal path **Page D.29**
- EGU 3 **Page D.30**
- EGU 4 symm., 2 signal paths **Page D.30**
- LPU symm., 2 signal paths **Page D.41**
- JACKPAC®, IP67 **Page D.32**
- RSU **Page D.36**
- LPU, non-earthed **Page D.47**
- Surge protection with ATEX approval **Page D.49**

Analogue signals

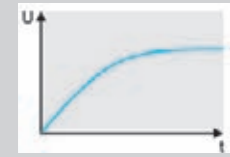

Two-, three- and four-wire versions without common reference potential

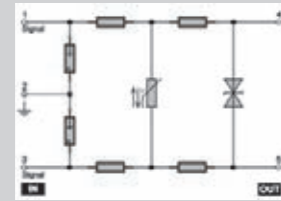

Signals from current loops (analogue measurements from sensors over long distances), 4...20 mA, 0...20 mA, etc., e.g. level measurements

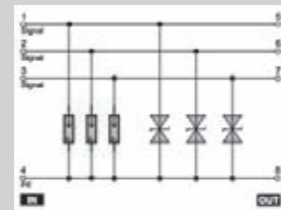

Signals from voltage sensors (analogue measurements from sensors over short distances), 0...10 V, PT100, etc., e.g. temperature measurements

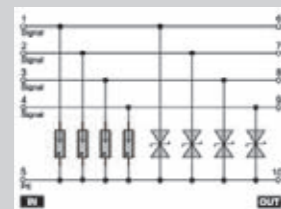

- MCZ OVP CL **Page D.9**
- DK5U **Page D.22**
- DK6U **Page D.23**
- EGU 3 for current loops **Page D.30**
- EGU 4 for current loops **Page D.30**
- JACKPAC®, IP67 **Page D.32**
- RSU 6 A / RSU 10 A **Page D.36**
- LPU for current loops **Page D.41**

D



# Slim Surge protection terminals for instrumentation and control engineering

Weidmüller MCZ surge protection terminals are characterized by their maximum protective function concentrated in a compact design of 6 mm. The tension spring connection and direct earthing via the terminal rail contact results in time-savings during installation. The MCZ OVP terminals are suitable for installing in the narrowest of places in automated process, industrial and building services systems.



The three-stage surge protection terminals are fitted with gas discharge tubes, varistors, suppression diodes (TAZ) and decoupling inductors. Individual protective components such as varistors and suppression diodes complement the range. The MCZ OVP surge protection terminals are available with rated voltages of 24, 48, 115 and 230 V. The response time for the 3-stage MCZ OVP is typically 100 ps. The earth contact is produced by clipping the terminal to an earthed terminal rail. To guarantee a safe energy discharge of up to 10 kA (8/20 µs) via these terminals, the TS 35 rail must therefore be earthed. EMC regulations require the terminal rail to be securely screwed to an earthed mounting plate. Optimum protection is achieved when the PE contact is made via a tension spring terminal every 600 mm.

## Attenuation chart MCZ OVP Filter

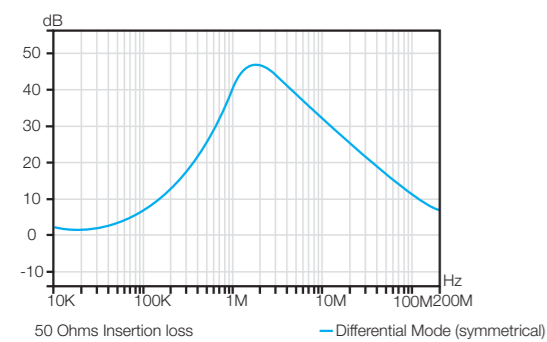

## The different models

**MCZ OVP HF** is a two-stage protective combination with a bridge circuit consisting of suppressor diodes. With this circuitry, high transmission rates of up to 100 Mhz can be reached in 100-Ohm systems.

The protective circuitry is particularly suitable for protecting high-speed data transmission system and high-speed analogue systems.

**MCZ OVP CL** is a three-stage protective combination with a suppression diode between the current paths. It limits the surge in analogue signal circuits, e.g. current loops.

**MCZ OVP SL** is a three-stage protective combination with two suppression diodes, each from the signal line to earth. It limits the surge in binary circuits, e.g. for actuators.

**MCZ OVP CL FG** is a three-stage protective combination with a suppression diode between the current paths. It limits the surge in analogue signal circuits. A high-resistance earth connection is achieved with a gas discharge tube.

**MCZ OVP SL FG** is a three-stage protective combination with two suppression diodes, each from the signal line to earth. It limits the surge in binary circuits, e.g. for actuators.

A high-resistance earth connection is achieved with three gas discharge tubes.

**MCZ OVP filter terminals** contain selected varistors, capacitors and series inductances. They form reliable noise filters. Coupled interference in the kHz range is safely discharged to earth. For example, the signal inputs of a PLC, which can be protected against interference voltages and RF interference.

## Derating curve MCZ OVP

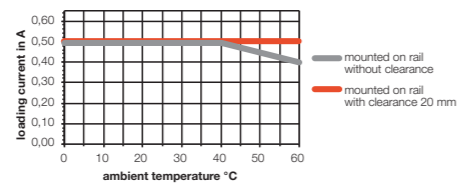

## Derating curve MCZ OVP

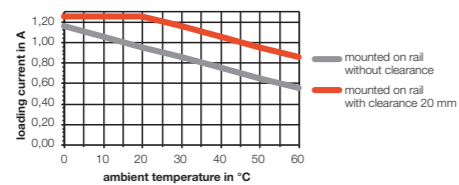

**2- stage protection with tension clamp connection**

- Slimline surge protection terminal with tension clamp connection
- 6 mm slimline fine surge protection
- fast wiring thanks to TS contact and tension clamp connections
- can be cross-connected using ZQV

**MCZ OVP HF 5V 0.3A**

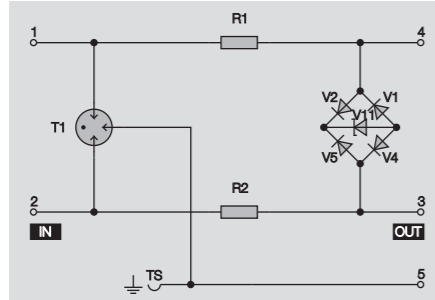
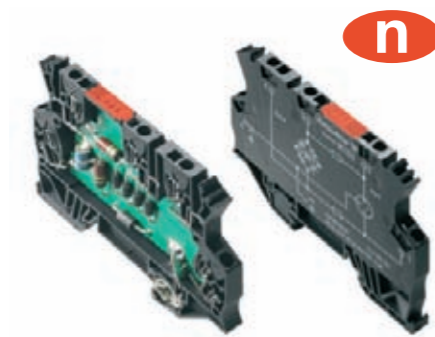

**MCZ OVP HF 12V 0.3A**

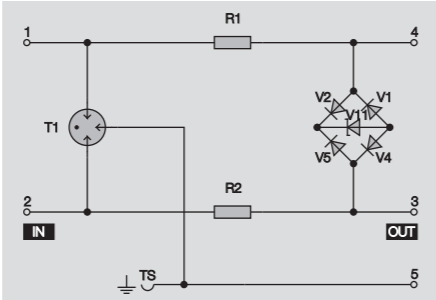
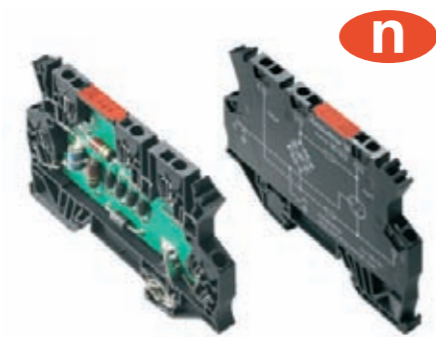

D



**Technical data**

Rated voltage (AC/DC)	5 V
max. continuous voltage, U <sub>c</sub> (DC)	10 V
max. continuous voltage, U <sub>c</sub> (AC)	7 V
Operating current, I <sub>max</sub>	0.3 A
Volume resistivity	2.50 Ω
Gas discharge tube	90 V
Varistor	
Suppression diodes	
Cut-off frequency (-3 dB) at load impedance	100.0 MHz (measured in 100 Ω system)
Discharge current, max. (8/20 μs)	5 kA
Protection level on output side sym., input 1 kV/μs, typ.	15 V
Protection level on output side sym., input 8/20 μs, typ.	15 V
Protection level on output side unsym., input 1kV/μs, typ.	15 V
Protection level on output side unsym., input 8/20 μs, typ.	30 V
Protection level on output side sym., input 10/350 μs, typ.	
Protection level on output side unsym., input 10/350 μs, typ.	
Lightning test voltage I imp (10/350 μs)	
Specification class to IEC 61643-21	C1 ;C2 ;C3 ;D1
Design	terminal
Storage temperature, min./max.	-40 °C/85 °C
Operating temperature, min./max.	-40 °C/60 °C
Approvals	CE

Rated voltage (AC/DC)	12 V
max. continuous voltage, U <sub>c</sub> (DC)	18.5 V
max. continuous voltage, U <sub>c</sub> (AC)	13 V
Operating current, I <sub>max</sub>	0.3 A
Volume resistivity	2.50 Ω
Gas discharge tube	90 V
Varistor	
Suppression diodes	
Cut-off frequency (-3 dB) at load impedance	100.0 MHz (measured in 100 Ω system)
Discharge current, max. (8/20 μs)	5 kA
Protection level on output side sym., input 1 kV/μs, typ.	25 V
Protection level on output side sym., input 8/20 μs, typ.	25 V
Protection level on output side unsym., input 1kV/μs, typ.	25 V
Protection level on output side unsym., input 8/20 μs, typ.	40 V
Protection level on output side sym., input 10/350 μs, typ.	
Protection level on output side unsym., input 10/350 μs, typ.	
Lightning test voltage I imp (10/350 μs)	
Specification class to IEC 61643-21	C1 ;C2 ;C3 ;D1
Design	terminal
Storage temperature, min./max.	-40 °C/85 °C
Operating temperature, min./max.	-40 °C/60 °C
Approvals	CE

Rated voltage (AC/DC)	12 V
max. continuous voltage, U <sub>c</sub> (DC)	18.5 V
max. continuous voltage, U <sub>c</sub> (AC)	13 V
Operating current, I <sub>max</sub>	0.3 A
Volume resistivity	2.50 Ω
Gas discharge tube	90 V
Varistor	
Suppression diodes	
Cut-off frequency (-3 dB) at load impedance	100.0 MHz (measured in 100 Ω system)
Discharge current, max. (8/20 μs)	5 kA
Protection level on output side sym., input 1 kV/μs, typ.	25 V
Protection level on output side sym., input 8/20 μs, typ.	25 V
Protection level on output side unsym., input 1kV/μs, typ.	25 V
Protection level on output side unsym., input 8/20 μs, typ.	40 V
Protection level on output side sym., input 10/350 μs, typ.	
Protection level on output side unsym., input 10/350 μs, typ.	
Lightning test voltage I imp (10/350 μs)	
Specification class to IEC 61643-21	C1 ;C2 ;C3 ;D1
Design	terminal
Storage temperature, min./max.	-40 °C/85 °C
Operating temperature, min./max.	-40 °C/60 °C
Approvals	CE

**Dimensions**

Clamping range (rating- / min. / max.)	mm²	1.5 / 0.5 / 1.5
Length x width x height	mm	91 x 6 x 63.5

Clamping range (rating- / min. / max.)	mm²	1.5 / 0.5 / 1.5
Length x width x height	mm	91 x 6 x 63.5

Clamping range (rating- / min. / max.)	mm²	1.5 / 0.5 / 1.5
Length x width x height	mm	91 x 6 x 63.5

**Ordering data**

Version	Type	Qty.	Order No.
	MCZ OVP HF 5V 0.3A	10	8948620000

Version	Type	Qty.	Order No.
	MCZ OVP HF 5V 0.3A	10	8948620000

Version	Type	Qty.	Order No.
	MCZ OVP HF 12V 0.3A	10	8948610000

Note

**Accessories**

Note	End plate AP MCZ 1.5: 1046410000
------	-------------------------------------

Note	End plate AP MCZ 1.5: 1046410000
------	-------------------------------------

Note	End plate AP MCZ 1.5: 1046410000
------	-------------------------------------

Surge protection for instrumentation and control equipment

**MC series**

**2- stage protection with tension clamp connection**

- Slimline surge protection terminal with tension clamp connection
- 6 mm slimline fine surge protection
- fast wiring thanks to TS contact and tension clamp connections
- can be cross-connected using ZQV

**MCZ OVP HF 24V 0.3A**

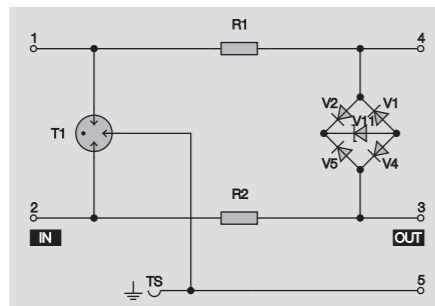

**Technical data**

Technical data	
Rated voltage (AC/DC)	24 V
max. continuous voltage, Uc (DC)	40 V
max. continuous voltage, Uc (AC)	28 V
Operating current, I <sub>max</sub>	0.3 A
Volume resistivity	2.50 Ω
Gas discharge tube	90 V
Varistor	
Suppression diodes	
Cut-off frequency (-3 dB) at load impedance	100.0 MHz (measured in 100 Ω system)
Discharge current, max. (8/20 μs)	5 kA
Protection level on output side sym., input 1 kV/μs, typ.	80 V
Protection level on output side sym., input 8/20 μs, typ.	80 V
Protection level on output side unsym., input 1kV/μs, typ.	80 V
Protection level on output side unsym., input 8/20 μs, typ.	150 V
Protection level on output side sym., input 10/350 μs, typ.	
Protection level on output side unsym., input 10/350 μs, typ.	
Lightning test voltage I <sub>imp</sub> (10/350 μs)	
Specification class to IEC 61643-21	C1 ;C2 ;C3 ;D1
Design	terminal
Storage temperature, min./max.	-40 °C/85 °C
Operating temperature, min./max.	-40 °C/60 °C
Approvals	CE

Dimensions	
Clamping range (rating- / min. / max.)	mm²
Length x width x height	mm

tension clamp connection	
	1.5 / 0.5 / 1.5
	91 x 6 x 63.5

**Ordering data**

Version	Type	Qty.	Order No.
	MCZ OVP HF 24V 0,3A	10	8948600000

Note	

**Accessories**

Note	
	End plate AP MCZ 1.5: 1046410000

**3- or 1-stage protection with tension clamp connection**

- Slimline surge protection terminal with tension clamp connection
- 6 mm slimline fine surge protection
- fast wiring thanks to TS contact and tension clamp connections
- can be cross-connected using ZQV

**MCZ OVP CL 24 V DC 0.5 A**

Protection for current loops

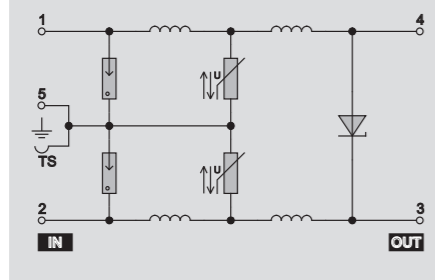

**MCZ OVP CL 24 V AC 0.5 A**

Protection for current loops

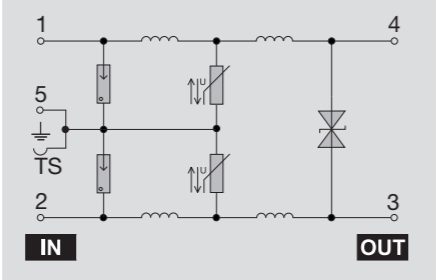
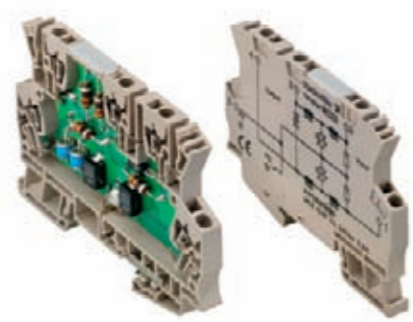

**Technical data**

<b>Technical data</b>	
Rated voltage (AC)	24 V
Rated voltage (DC)	28 V
max. continuous voltage, U <sub>c</sub> (AC)	38 V
Operating current, I <sub>max</sub>	0.5 A
Volume resistivity	2.50 Ω
Gas discharge tube	yes
Varistor	yes
Suppression diodes	yes
Cut-off frequency (-3 dB) at load impedance	500.0 kHz 240 Ω
Discharge current, max. (8/20 μs)	5 kA
Protection level on output side sym., input 1 kV/μs, typ.	40 V
Protection level on output side sym., input 8/20 μs, typ.	65 V
Protection level on output side unsym., input 1kV/μs, typ.	40 V
Protection level on output side unsym., input 8/20 μs, typ.	65 V
Protection level on output side sym., input 10/350 μs, typ.	48 V
Protection level on output side unsym., input 10/350 μs, typ.	88 V
Lightning test voltage I imp (10/350 μs)	1 kA
Specification class to IEC 61643-21	D1
Design	terminal
Ambient temperature (operational)	-40 ... 60°C
Storage temperature	-40 ... 85°C
Approvals	CE,UL listed

**Dimensions**

Clamping range (rating- / min. / max.)	mm <sup>2</sup>
Length x width x height	mm

**Note**

**Ordering data**

<b>Version</b>
<b>Note</b>

**Accessories**

**Note**

<b>tension clamp connection</b>		
Clamping range (rating- / min. / max.)	mm <sup>2</sup>	1.5 / 0.5 / 1.5
Length x width x height	mm	91 x 6 x 63.5
<b>Note</b>		Refer to derating curve

<b>Type</b>	<b>Qty.</b>	<b>Order No.</b>
MCZ OVP CL 24VDC 0,5A	10	8448920000
<b>Note</b>		

**Note**

<b>tension clamp connection</b>		
Clamping range (rating- / min. / max.)	mm <sup>2</sup>	1.5 / 0.5 / 1.5
Length x width x height	mm	91 x 6 x 63.5
<b>Note</b>		Refer to derating curve

<b>Type</b>	<b>Qty.</b>	<b>Order No.</b>
MCZ OVP CL 24VAC 0,5A	10	8472880000
<b>Note</b>		

**Note**





## MC series

### 3- or 1-stage protection with tension clamp connection

- Slimline surge protection terminal with tension clamp connection
- 6 mm slimline fine surge protection
- fast wiring thanks to TS contact and tension clamp connections
- can be cross-connected using ZQV

### MCZ OVP CL 24 V UC 1.25 A

Protection for current loops

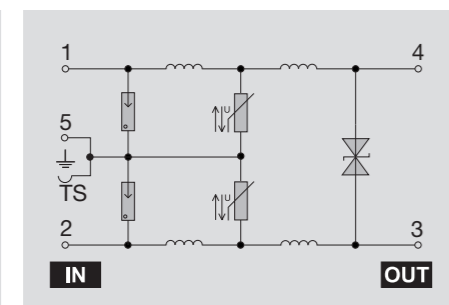

### MCZ OVP SL 24 V DC 0.5 A

Protection for binary signals

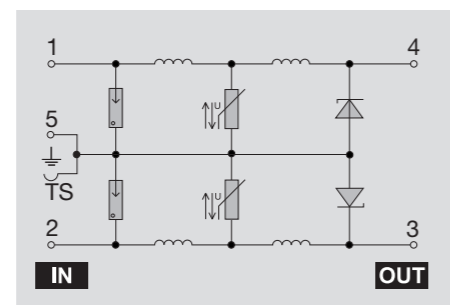

## Technical data

Technical data	
Rated voltage (AC)	24 V
Rated voltage (DC)	24 V
max. continuous voltage, U <sub>c</sub> (AC)	27 V
Operating current, I <sub>max</sub>	1.3 A
Volume resistivity	1.00 Ω
Gas discharge tube	yes
Varistor	yes
Suppression diodes	yes
Cut-off frequency (-3 dB) at load impedance	500.0 kHz 240 Ω
Discharge current, max. (8/20 μs)	5 kA
Protection level on output side sym., input 1 kV/μs, typ.	80 V
Protection level on output side sym., input 8/20 μs, typ.	130 V
Protection level on output side unsym., input 1kV/μs, typ.	40 V
Protection level on output side unsym., input 8/20 μs, typ.	65 V
Protection level on output side sym., input 10/350 μs, typ.	58 V
Protection level on output side unsym., input 10/350 μs, typ.	76 V
Lightning test voltage I <sub>imp</sub> (10/350 μs)	1 kA
Specification class to IEC 61643-21	D1
Design	terminal
Ambient temperature (operational)	-40 ... 60°C
Storage temperature	-40 ... 85°C
Approvals	CE,UL listed

Rated voltage (AC)	24 V
Rated voltage (DC)	24 V
max. continuous voltage, U <sub>c</sub> (AC)	27 V
Operating current, I <sub>max</sub>	1.3 A
Volume resistivity	1.00 Ω
Gas discharge tube	yes
Varistor	yes
Suppression diodes	yes
Cut-off frequency (-3 dB) at load impedance	500.0 kHz 240 Ω
Discharge current, max. (8/20 μs)	5 kA
Protection level on output side sym., input 1 kV/μs, typ.	80 V
Protection level on output side sym., input 8/20 μs, typ.	130 V
Protection level on output side unsym., input 1kV/μs, typ.	40 V
Protection level on output side unsym., input 8/20 μs, typ.	65 V
Protection level on output side sym., input 10/350 μs, typ.	58 V
Protection level on output side unsym., input 10/350 μs, typ.	76 V
Lightning test voltage I <sub>imp</sub> (10/350 μs)	1 kA
Specification class to IEC 61643-21	D1
Design	terminal
Ambient temperature (operational)	-40 ... 60°C
Storage temperature	-40 ... 85°C
Approvals	CE,UL listed

Rated voltage (AC)	24 V
Rated voltage (DC)	28 V
max. continuous voltage, U <sub>c</sub> (AC)	27 V
Operating current, I <sub>max</sub>	0.5 A
Volume resistivity	2.50 Ω
Gas discharge tube	yes
Varistor	yes
Suppression diodes	yes
Cut-off frequency (-3 dB) at load impedance	500.0 kHz 240 Ω
Discharge current, max. (8/20 μs)	5 kA
Protection level on output side sym., input 1 kV/μs, typ.	80 V
Protection level on output side sym., input 8/20 μs, typ.	130 V
Protection level on output side unsym., input 1kV/μs, typ.	40 V
Protection level on output side unsym., input 8/20 μs, typ.	65 V
Protection level on output side sym., input 10/350 μs, typ.	40 V
Protection level on output side unsym., input 10/350 μs, typ.	42 V
Lightning test voltage I <sub>imp</sub> (10/350 μs)	1 kA
Specification class to IEC 61643-21	D1
Design	terminal
Ambient temperature (operational)	-40 ... 60°C
Storage temperature	-40 ... 85°C
Approvals	CE,UL listed

## Dimensions

Clamping range (rating- / min. / max.)	mm²
Length x width x height	mm

## tension clamp connection

Clamping range (rating- / min. / max.)	1.5 / 0.5 / 1.5
Length x width x height	91 x 6 x 63.5

## tension clamp connection

Clamping range (rating- / min. / max.)	1.5 / 0.5 / 1.5
Length x width x height	91 x 6 x 63.5

## Note

Refer to derating curve

Refer to derating curve

## Ordering data

Version	Type	Qty.	Order No.
	MCZ OVP CL 24VUC 1,25A	10	8448960000

Type	Qty.	Order No.
MCZ OVP CL 24VUC 1,25A	10	8448960000

Type	Qty.	Order No.
MCZ OVP SL 24VDC 0,5A	10	8448940000

## Note

Refer to derating curve

Refer to derating curve

## Accessories

End plate	AP MCZ 1.5: 8389030000
-----------	------------------------

End plate	AP MCZ 1.5: 8389030000
-----------	------------------------

End plate	AP MCZ 1.5: 8389030000
-----------	------------------------



**3- or 1-stage protection with tension clamp connection**

- Slimline surge protection terminal with tension clamp connection
- 6 mm slimline fine surge protection
- fast wiring thanks to TS contact and tension clamp connections
- can be cross-connected using ZQV

**MCZ OVP SL 24 V UC 1.25 A**

Protection for binary signals

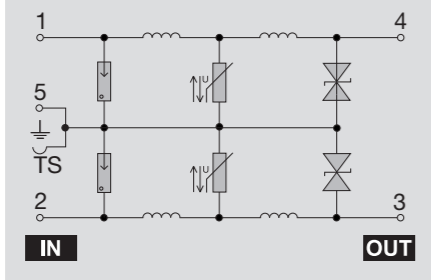

**MCZ OVP CL 48 V UC 0.5 A**

Protection for current loops

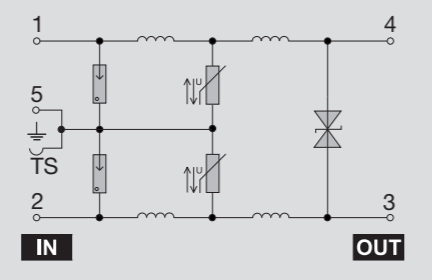
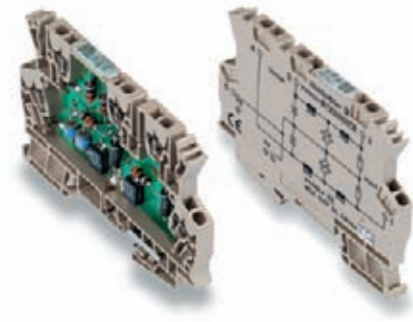

D



Surge protection for instrumentation and control equipment

**Technical data**

Rated voltage (AC)	24 V
Rated voltage (DC)	24 V
max. continuous voltage, U <sub>c</sub> (AC)	28 V
Operating current, I <sub>max</sub>	1.3 A
Volume resistivity	1.00 Ω
Gas discharge tube	yes
Varistor	yes
Suppression diodes	yes
Cut-off frequency (-3 dB) at load impedance	500.0 kHz 240 Ω
Discharge current, max. (8/20 μs)	5 kA
Protection level on output side sym., input 1 kV/μs, typ.	80 V
Protection level on output side sym., input 8/20 μs, typ.	130 V
Protection level on output side unsym., input 1kV/μs, typ.	40 V
Protection level on output side unsym., input 8/20 μs, typ.	65 V
Protection level on output side sym., input 10/350 μs, typ.	108 V
Protection level on output side unsym., input 10/350 μs, typ.	56 V
Lightning test voltage I imp (10/350 μs)	1 kA
Specification class to IEC 61643-21	D1
Design	terminal
Ambient temperature (operational)	-40 ... 60°C
Storage temperature	-40 ... 85°C
Approvals	CE,UL listed

**Dimensions**

Clamping range (rating- / min. / max.)	mm <sup>2</sup>
Length x width x height	mm

Note

**Ordering data**

Version	Type	Qty.	Order No.
	MCZ OVP SL 24VUC 1,25A	10	8448970000

Note

**Accessories**

Note

End plate  
AP MCZ 1.5: 8389030000

**Technical data**

Rated voltage (AC)	48 V
Rated voltage (DC)	48 V
max. continuous voltage, U <sub>c</sub> (AC)	53 V
Operating current, I <sub>max</sub>	0.5 A
Volume resistivity	2.50 Ω
Gas discharge tube	yes
Varistor	yes
Suppression diodes	yes
Cut-off frequency (-3 dB) at load impedance	500.0 kHz 240 Ω
Discharge current, max. (8/20 μs)	5 kA
Protection level on output side sym., input 1 kV/μs, typ.	82 V
Protection level on output side sym., input 8/20 μs, typ.	150 V
Protection level on output side unsym., input 1kV/μs, typ.	80 V
Protection level on output side unsym., input 8/20 μs, typ.	150 V
Protection level on output side sym., input 10/350 μs, typ.	149 V
Protection level on output side unsym., input 10/350 μs, typ.	223 V
Lightning test voltage I imp (10/350 μs)	2.5 kA
Specification class to IEC 61643-21	D1
Design	terminal
Ambient temperature (operational)	-40 ... 60°C
Storage temperature	-40 ... 85°C
Approvals	CE,UL listed

**Dimensions**

Clamping range (rating- / min. / max.)	mm <sup>2</sup>
Length x width x height	mm

Note

**Ordering data**

Version	Type	Qty.	Order No.
	MCZ OVP CL 48VUC 0,5A	10	8449000000

Note

**Accessories**

Note

End plate  
AP MCZ 1.5: 8389030000

**MC series**

**3- or 1-stage protection with tension clamp connection**

- Slimline surge protection terminal with tension clamp connection
- 6 mm slimline fine surge protection
- fast wiring thanks to TS contact and tension clamp connections
- can be cross-connected using ZQV

**MCZ OVP SL 48 V UC 0.5 A**

Protection for binary signals

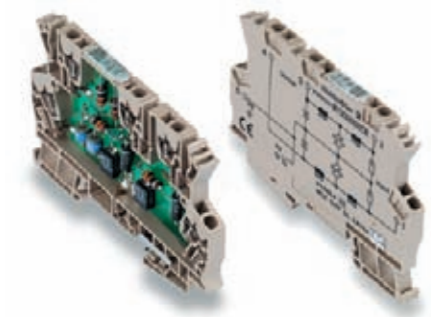

**MCZ OVP CL 48 V UC 1.25 A**

Protection for current loops

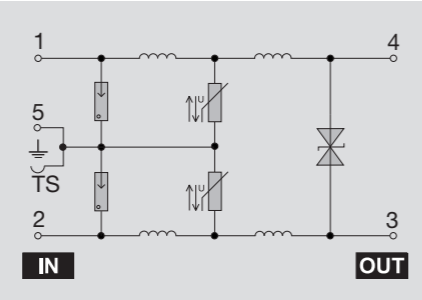
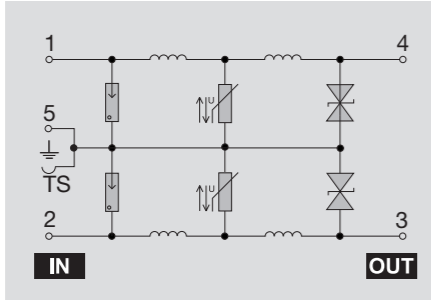
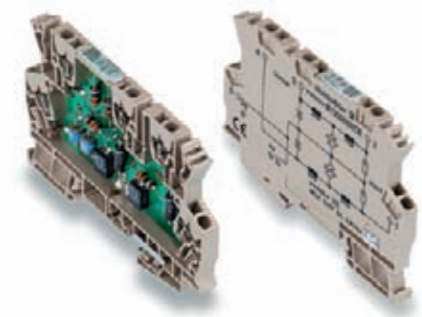

**Technical data**

Rated voltage (AC)	48 V
Rated voltage (DC)	48 V
max. continuous voltage, U <sub>c</sub> (AC)	53 V
Operating current, I <sub>max</sub>	0.5 A
Volume resistivity	2.50 Ω
Gas discharge tube	yes
Varistor	yes
Suppression diodes	yes
Cut-off frequency (-3 dB) at load impedance	500.0 kHz 240 Ω
Discharge current, max. (8/20 μs)	5 kA
Protection level on output side sym., input 1 kV/μs, typ.	160 V
Protection level on output side sym., input 8/20 μs, typ.	300 V
Protection level on output side unsym., input 1kV/μs, typ.	82 V
Protection level on output side unsym., input 8/20 μs, typ.	150 V
Protection level on output side sym., input 10/350 μs, typ.	145 V
Protection level on output side unsym., input 10/350 μs, typ.	81 V
Lightning test voltage I imp (10/350 μs)	1 kA
Specification class to IEC 61643-21	D1
Design	terminal
Ambient temperature (operational)	-40 ... 60°C
Storage temperature	-40 ... 85°C
Approvals	CE,UL listed

Rated voltage (AC)	48 V
Rated voltage (DC)	48 V
max. continuous voltage, U <sub>c</sub> (AC)	53 V
Operating current, I <sub>max</sub>	1.3 A
Volume resistivity	1.00 Ω
Gas discharge tube	yes
Varistor	yes
Suppression diodes	yes
Cut-off frequency (-3 dB) at load impedance	500.0 kHz 240 Ω
Discharge current, max. (8/20 μs)	5 kA
Protection level on output side sym., input 1 kV/μs, typ.	82 V
Protection level on output side sym., input 8/20 μs, typ.	150 V
Protection level on output side unsym., input 1kV/μs, typ.	82 V
Protection level on output side unsym., input 8/20 μs, typ.	150 V
Protection level on output side sym., input 10/350 μs, typ.	94 V
Protection level on output side unsym., input 10/350 μs, typ.	193 V
Lightning test voltage I imp (10/350 μs)	1 kA
Specification class to IEC 61643-21	D1
Design	terminal
Ambient temperature (operational)	-40 ... 60°C
Storage temperature	-40 ... 85°C
Approvals	CE,UL listed

Rated voltage (AC)	48 V
Rated voltage (DC)	48 V
max. continuous voltage, U <sub>c</sub> (AC)	53 V
Operating current, I <sub>max</sub>	1.3 A
Volume resistivity	1.00 Ω
Gas discharge tube	yes
Varistor	yes
Suppression diodes	yes
Cut-off frequency (-3 dB) at load impedance	500.0 kHz 240 Ω
Discharge current, max. (8/20 μs)	5 kA
Protection level on output side sym., input 1 kV/μs, typ.	82 V
Protection level on output side sym., input 8/20 μs, typ.	150 V
Protection level on output side unsym., input 1kV/μs, typ.	82 V
Protection level on output side unsym., input 8/20 μs, typ.	150 V
Protection level on output side sym., input 10/350 μs, typ.	94 V
Protection level on output side unsym., input 10/350 μs, typ.	193 V
Lightning test voltage I imp (10/350 μs)	1 kA
Specification class to IEC 61643-21	D1
Design	terminal
Ambient temperature (operational)	-40 ... 60°C
Storage temperature	-40 ... 85°C
Approvals	CE,UL listed

<b>Dimensions</b>	
Clamping range (rating- / min. / max.)	mm²
Length x width x height	mm
<b>Note</b>	Refer to derating curve

<b>tension clamp connection</b>	
Clamping range (rating- / min. / max.)	1.5 / 0.5 / 1.5
Length x width x height	91 x 6 x 63.5
<b>Note</b>	Refer to derating curve

<b>tension clamp connection</b>	
Clamping range (rating- / min. / max.)	1.5 / 0.5 / 1.5
Length x width x height	91 x 6 x 63.5
<b>Note</b>	Refer to derating curve

**Ordering data**

<b>Version</b>	<b>Type</b>	<b>Qty.</b>	<b>Order No.</b>
	MCZ OVP SL 48VUC 0,5A	10	8449030000
<b>Note</b>			

<b>Type</b>	<b>Qty.</b>	<b>Order No.</b>
MCZ OVP SL 48VUC 0,5A	10	8449030000
<b>Note</b>		

<b>Type</b>	<b>Qty.</b>	<b>Order No.</b>
MCZ OVP CL 48VUC 1,25A	10	8449040000
<b>Note</b>		

**Accessories**

<b>Note</b>	End plate AP MCZ 1.5: 8389030000
-------------	-------------------------------------

<b>Note</b>	End plate AP MCZ 1.5: 8389030000
-------------	-------------------------------------

<b>Note</b>	End plate AP MCZ 1.5: 8389030000
-------------	-------------------------------------



**3- or 1-stage protection with tension clamp connection**

- Slimline surge protection terminal with tension clamp connection
- 6 mm slimline fine surge protection
- fast wiring thanks to TS contact and tension clamp connections
- can be cross-connected using ZQV

**MCZ OVP SL 48 V UC 1.25 A**

Protection for binary signals

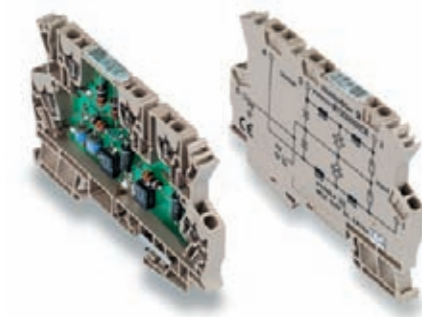

**MCZ OVP CL 115 V UC 1.25 A**

Protection for current loops

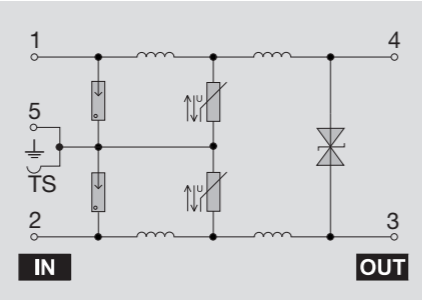
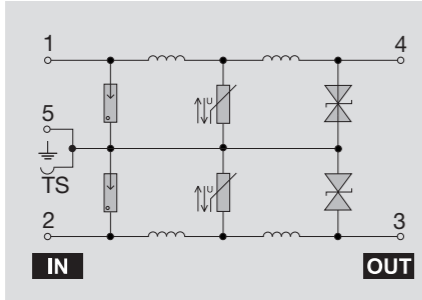
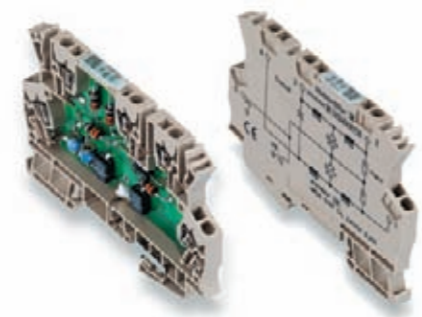

**Technical data**

Rated voltage (AC)	48 V
Rated voltage (DC)	48 V
max. continuous voltage, U <sub>c</sub> (AC)	53 V
Operating current, I <sub>max</sub>	1.3 A
Volume resistivity	1.00 Ω
Gas discharge tube	yes
Varistor	yes
Suppression diodes	yes
Cut-off frequency (-3 dB) at load impedance	500.0 kHz 240 Ω
Discharge current, max. (8/20 μs)	5 kA
Protection level on output side sym., input 1 kV/μs, typ.	160 V
Protection level on output side sym., input 8/20 μs, typ.	300 V
Protection level on output side unsym., input 1kV/μs, typ.	80 V
Protection level on output side unsym., input 8/20 μs, typ.	150 V
Protection level on output side sym., input 10/350 μs, typ.	197 V
Protection level on output side unsym., input 10/350 μs, typ.	119 V
Lightning test voltage I <sub>imp</sub> (10/350 μs)	2.5 kA
Specification class to IEC 61643-21	D1
Design	terminal
Ambient temperature (operational)	-40 ... 60°C
Storage temperature	-40 ... 85°C
Approvals	CE, UL listed

Rated voltage (AC)	48 V
Rated voltage (DC)	48 V
max. continuous voltage, U <sub>c</sub> (AC)	53 V
Operating current, I <sub>max</sub>	1.3 A
Volume resistivity	1.00 Ω
Gas discharge tube	yes
Varistor	yes
Suppression diodes	yes
Cut-off frequency (-3 dB) at load impedance	500.0 kHz 240 Ω
Discharge current, max. (8/20 μs)	5 kA
Protection level on output side sym., input 1 kV/μs, typ.	160 V
Protection level on output side sym., input 8/20 μs, typ.	300 V
Protection level on output side unsym., input 1kV/μs, typ.	80 V
Protection level on output side unsym., input 8/20 μs, typ.	150 V
Protection level on output side sym., input 10/350 μs, typ.	197 V
Protection level on output side unsym., input 10/350 μs, typ.	119 V
Lightning test voltage I <sub>imp</sub> (10/350 μs)	2.5 kA
Specification class to IEC 61643-21	D1
Design	terminal
Ambient temperature (operational)	-40 ... 60°C
Storage temperature	-40 ... 85°C
Approvals	CE, UL listed

Rated voltage (AC)	115 V
Rated voltage (DC)	115 V
max. continuous voltage, U <sub>c</sub> (AC)	127 V
Operating current, I <sub>max</sub>	1.3 A
Volume resistivity	1.00 Ω
Gas discharge tube	yes
Varistor	yes
Suppression diodes	yes
Cut-off frequency (-3 dB) at load impedance	500.0 kHz 240 Ω
Discharge current, max. (8/20 μs)	5 kA
Protection level on output side sym., input 1 kV/μs, typ.	220 V
Protection level on output side sym., input 8/20 μs, typ.	360 V
Protection level on output side unsym., input 1kV/μs, typ.	220 V
Protection level on output side unsym., input 8/20 μs, typ.	360 V
Protection level on output side sym., input 10/350 μs, typ.	228 V
Protection level on output side unsym., input 10/350 μs, typ.	234 V
Lightning test voltage I <sub>imp</sub> (10/350 μs)	1 kA
Specification class to IEC 61643-21	D1
Design	terminal
Ambient temperature (operational)	-40 ... 60°C
Storage temperature	-40 ... 85°C
Approvals	CE,

**Dimensions**

Clamping range (rating- / min. / max.)	mm²	1.5 / 0.5 / 1.5
Length x width x height	mm	91 x 6 x 63.5

**tension clamp connection**

Clamping range (rating- / min. / max.)	mm²	1.5 / 0.5 / 1.5
Length x width x height	mm	91 x 6 x 63.5

**tension clamp connection**

Clamping range (rating- / min. / max.)	mm²	1.5 / 0.5 / 1.5
Length x width x height	mm	91 x 6 x 63.5

**Note**

Refer to derating curve

Refer to derating curve

**Ordering data**

Version	Type	Qty.	Order No.
	MCZ OVP SL 48VUC 1,25A	10	8449050000

Version	Type	Qty.	Order No.
	MCZ OVP SL 48VUC 1,25A	10	8449050000

Version	Type	Qty.	Order No.
	MCZ OVP CL 115VUC 1,25A	10	8449060000

**Note**

**Accessories**

End plate	AP MCZ 1.5: 8389030000
-----------	------------------------

End plate	AP MCZ 1.5: 8389030000
-----------	------------------------

End plate	AP MCZ 1.5: 8389030000
-----------	------------------------



**MC series**

**3- or 1-stage protection with tension clamp connection**

- Slimline surge protection terminal with tension clamp connection
- 6 mm slimline fine surge protection
- fast wiring thanks to TS contact and tension clamp connections
- can be cross-connected using ZQV

**MCZ OVP SL 115 V UC 1.25 A**

Protection for binary signals

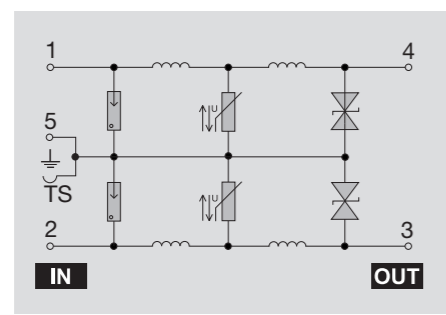
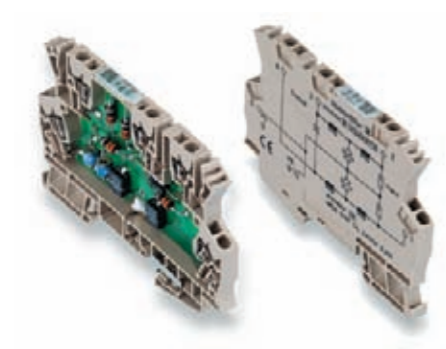

**MCZ OVP CL 230 V UC 1.25 A**

Protection for current loops

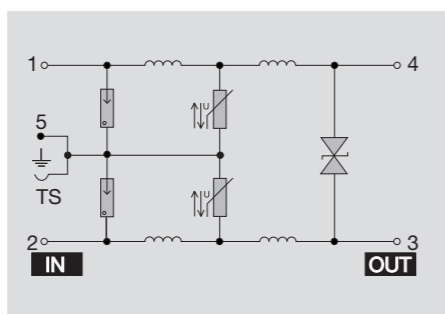
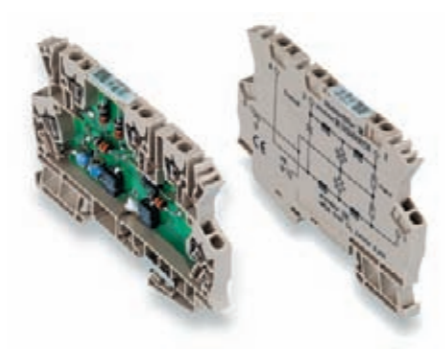

**Technical data**

Rated voltage (AC)	115 V
Rated voltage (DC)	115 V
max. continuous voltage, U <sub>c</sub> (AC)	127 V
Operating current, I <sub>max</sub>	1.3 A
Volume resistivity	1.00 Ω
Gas discharge tube	yes
Varistor	yes
Suppression diodes	yes
Cut-off frequency (-3 dB) at load impedance	500.0 kHz 240 Ω
Discharge current, max. (8/20 μs)	5 kA
Protection level on output side sym., input 1 kV/μs, typ.	440 V
Protection level on output side sym., input 8/20 μs, typ.	720 V
Protection level on output side unsym., input 1kV/μs, typ.	220 V
Protection level on output side unsym., input 8/20 μs, typ.	360 V
Protection level on output side sym., input 10/350 μs, typ.	249 V
Protection level on output side unsym., input 10/350 μs, typ.	322 V
Lightning test voltage I imp (10/350 μs)	2.5 kA
Specification class to IEC 61643-21	D1
Design	terminal
Ambient temperature (operational)	-40 ... 60°C
Storage temperature	-40 ... 85°C
Approvals	CE:

Rated voltage (AC)	115 V
Rated voltage (DC)	115 V
max. continuous voltage, U <sub>c</sub> (AC)	127 V
Operating current, I <sub>max</sub>	1.3 A
Volume resistivity	1.00 Ω
Gas discharge tube	yes
Varistor	yes
Suppression diodes	yes
Cut-off frequency (-3 dB) at load impedance	500.0 kHz 240 Ω
Discharge current, max. (8/20 μs)	5 kA
Protection level on output side sym., input 1 kV/μs, typ.	440 V
Protection level on output side sym., input 8/20 μs, typ.	720 V
Protection level on output side unsym., input 1kV/μs, typ.	220 V
Protection level on output side unsym., input 8/20 μs, typ.	360 V
Protection level on output side sym., input 10/350 μs, typ.	249 V
Protection level on output side unsym., input 10/350 μs, typ.	322 V
Lightning test voltage I imp (10/350 μs)	2.5 kA
Specification class to IEC 61643-21	D1
Design	terminal
Ambient temperature (operational)	-40 ... 60°C
Storage temperature	-40 ... 85°C
Approvals	CE:

Rated voltage (AC)	230 V
Rated voltage (DC)	230 V
max. continuous voltage, U <sub>c</sub> (AC)	250 V
Operating current, I <sub>max</sub>	1.3 A
Volume resistivity	1.00 Ω
Gas discharge tube	yes
Varistor	yes
Suppression diodes	yes
Cut-off frequency (-3 dB) at load impedance	500.0 kHz 240 Ω
Discharge current, max. (8/20 μs)	5 kA
Protection level on output side sym., input 1 kV/μs, typ.	420 V
Protection level on output side sym., input 8/20 μs, typ.	710 V
Protection level on output side unsym., input 1kV/μs, typ.	420 V
Protection level on output side unsym., input 8/20 μs, typ.	710 V
Protection level on output side sym., input 10/350 μs, typ.	497 V
Protection level on output side unsym., input 10/350 μs, typ.	945 V
Lightning test voltage I imp (10/350 μs)	0.5 kA
Specification class to IEC 61643-21	D1
Design	terminal
Ambient temperature (operational)	-40 ... 60°C
Storage temperature	-40 ... 85°C
Approvals	CE:

<b>Dimensions</b>	
Clamping range (rating- / min. / max.)	mm²
Length x width x height	mm
<b>Note</b>	Refer to derating curve

<b>tension clamp connection</b>	
Clamping range (rating- / min. / max.)	1.5 / 0.5 / 1.5
Length x width x height	91 x 6 x 63.5
<b>Note</b>	Refer to derating curve

<b>tension clamp connection</b>	
Clamping range (rating- / min. / max.)	1.5 / 0.5 / 1.5
Length x width x height	91 x 6 x 63.5
<b>Note</b>	Refer to derating curve

**Ordering data**

<b>Version</b>	<b>Type</b>	<b>Qty.</b>	<b>Order No.</b>
	MCZ OVP SL 115VUC 1,25A	10	8449070000

<b>Type</b>	<b>Qty.</b>	<b>Order No.</b>
MCZ OVP SL 115VUC 1,25A	10	8449070000

<b>Type</b>	<b>Qty.</b>	<b>Order No.</b>
MCZ OVP CL 230VUC 1,25A	10	8449080000

**Note**

**Note**

**Note**

**Accessories**

<b>Note</b>	End plate AP MCZ 1.5: 8389030000
-------------	-------------------------------------

<b>Note</b>	End plate AP MCZ 1.5: 8389030000
-------------	-------------------------------------

<b>Note</b>	End plate AP MCZ 1.5: 8389030000
-------------	-------------------------------------

**3- or 1-stage protection with tension clamp connection**

- Slimline surge protection terminal with tension clamp connection
- 6 mm slimline fine surge protection
- fast wiring thanks to TS contact and tension clamp connections
- can be cross-connected using ZQV

**MCZ SL FG 24 V AC 0.5 A**

not earthed

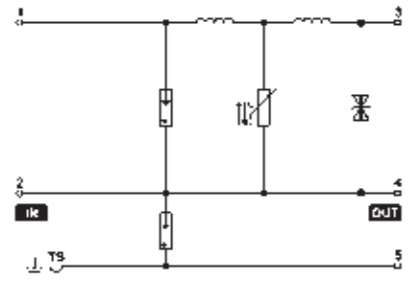
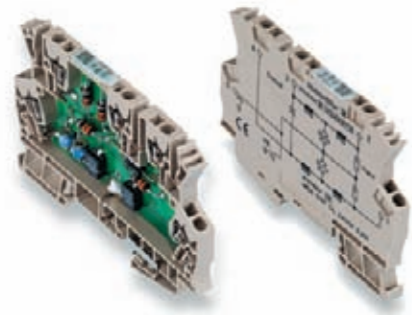

**MCZ CL FG 24 V AC 0.5 A**

not earthed

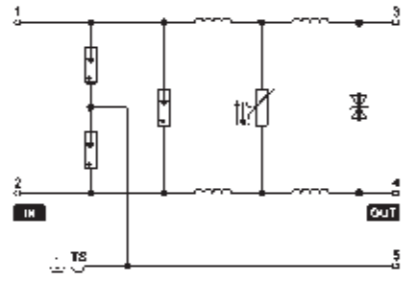
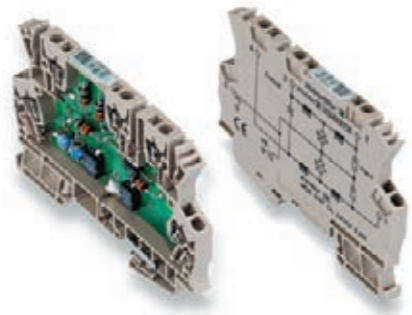

Surge protection for instrumentation and control equipment



**Technical data**

Rated voltage (AC)	24 V
Rated voltage (DC)	24 V
max. continuous voltage, U <sub>c</sub> (AC)	28 V
Operating current, I <sub>max</sub>	0.5 A
Volume resistivity	1.00 Ω
Gas discharge tube	90 V / 10 kA
Varistor	30 V
Suppression diodes	
Cut-off frequency (-3 dB) at load impedance	500.0 kHz / 240 Ω
Discharge current, max. (8/20 μs)	5 kA
Protection level on output side sym., input 1 kV/μs, typ.	40 V
Protection level on output side sym., input 8/20 μs, typ.	65 V
Protection level on output side unsym., input 1kV/μs, typ.	40 V
Protection level on output side unsym., input 8/20 μs, typ.	65 V
Protection level on output side sym., input 10/350 μs, typ.	56 V
Protection level on output side unsym., input 10/350 μs, typ.	812 V
Lightning test voltage I <sub>imp</sub> (10/350 μs)	1 kA
Specification class to IEC 61643-21	D1
Design	terminal
Ambient temperature (operational)	-40 ... 60°C
Storage temperature	-40 ... 85°C
Approvals	CE,UL listed

**Dimensions**

Clamping range (rating- / min. / max.)	mm <sup>2</sup>	1.5 / 0.5 / 1.5
Length x width x height	mm	91 x 6 x 63.5

**Note**

**tension clamp connection**

Clamping range (rating- / min. / max.)	mm <sup>2</sup>	1.5 / 0.5 / 1.5
Length x width x height	mm	91 x 6 x 63.5

Refer to derating curve

**Ordering data**

Version	Type	Qty.	Order No.
	MCZ OVP SL FG 24VUC 0,5A	10	8823280000

**Note**

**Accessories**

<b>Note</b>	End plate AP MCZ 1.5: 8389030000
-------------	-------------------------------------

**tension clamp connection**

Clamping range (rating- / min. / max.)	mm <sup>2</sup>	1.5 / 0.5 / 1.5
Length x width x height	mm	91 x 6 x 63.5

Refer to derating curve

Version	Type	Qty.	Order No.
	MCZ OVP CL FG 24VUC 0,5A	10	8704240000

**Note**

<b>Note</b>	End plate AP MCZ 1.5: 8389030000
-------------	-------------------------------------



**3- or 1-stage protection with tension clamp connection**

- Slimline surge protection terminal with tension clamp connection
- 6 mm slimline fine surge protection
- fast wiring thanks to TS contact and tension clamp connections
- can be cross-connected using ZQV

**MCZ OVP 90 V**

Gas discharge tube / EIB-capable



**MCZ OVP S10K30**

Varistor S10K30

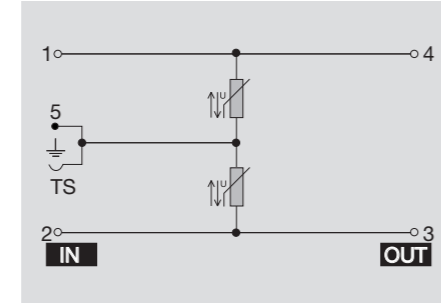
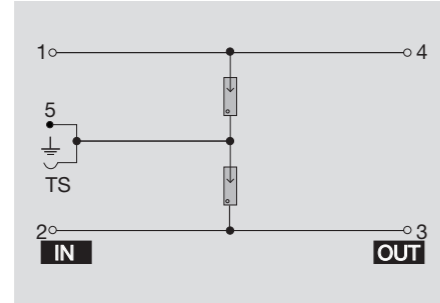

**Technical data**

<b>Technical data</b>	
Rated voltage (AC)	50 V
Rated voltage (DC)	70 V
max. continuous voltage, U <sub>c</sub> (AC)	72 V
Operating current, I <sub>max</sub>	13 A
Volume resistivity	0.20 Ω
Gas discharge tube	90 V / 10 kA
Varistor	no
Suppression diodes	no
Cut-off frequency (-3 dB) at load impedance	
Discharge current, max. (8/20 μs)	5 kA
Protection level on output side sym., input 1 kV/μs, typ.	700 V
Protection level on output side sym., input 8/20 μs, typ.	800 V
Protection level on output side unsym., input 1kV/μs, typ.	700 V
Protection level on output side unsym., input 8/20 μs, typ.	800 V
Protection level on output side sym., input 10/350 μs, typ.	763 V
Protection level on output side unsym., input 10/350 μs, typ.	782 V
Lightning test voltage I imp (10/350 μs)	1 kA
Specification class to IEC 61643-21	D1
Design	terminal
Ambient temperature (operational)	-40 ... 60 °C
Storage temperature	-40 ... 85 °C
Approvals	CE,UL listed

<b>Technical data</b>	
Rated voltage (AC)	50 V
Rated voltage (DC)	70 V
max. continuous voltage, U <sub>c</sub> (AC)	72 V
Operating current, I <sub>max</sub>	13 A
Volume resistivity	0.20 Ω
Gas discharge tube	90 V / 10 kA
Varistor	no
Suppression diodes	no
Cut-off frequency (-3 dB) at load impedance	
Discharge current, max. (8/20 μs)	5 kA
Protection level on output side sym., input 1 kV/μs, typ.	700 V
Protection level on output side sym., input 8/20 μs, typ.	800 V
Protection level on output side unsym., input 1kV/μs, typ.	700 V
Protection level on output side unsym., input 8/20 μs, typ.	800 V
Protection level on output side sym., input 10/350 μs, typ.	763 V
Protection level on output side unsym., input 10/350 μs, typ.	782 V
Lightning test voltage I imp (10/350 μs)	1 kA
Specification class to IEC 61643-21	D1
Design	terminal
Ambient temperature (operational)	-40 ... 60 °C
Storage temperature	-40 ... 85 °C
Approvals	CE,UL listed

<b>Technical data</b>	
Rated voltage (AC)	24 V
Rated voltage (DC)	24 V
max. continuous voltage, U <sub>c</sub> (AC)	30 V
Operating current, I <sub>max</sub>	13 A
Volume resistivity	0.20 Ω
Gas discharge tube	no
Varistor	yes
Suppression diodes	no
Cut-off frequency (-3 dB) at load impedance	
Discharge current, max. (8/20 μs)	125 A
Protection level on output side sym., input 1 kV/μs, typ.	45 V
Protection level on output side sym., input 8/20 μs, typ.	55 V
Protection level on output side unsym., input 1kV/μs, typ.	45 V
Protection level on output side unsym., input 8/20 μs, typ.	55 V
Protection level on output side sym., input 10/350 μs, typ.	263 V
Protection level on output side unsym., input 10/350 μs, typ.	136 V
Lightning test voltage I imp (10/350 μs)	0.5 kA
Specification class to IEC 61643-21	D1
Design	terminal
Ambient temperature (operational)	-40 ... 60 °C
Storage temperature	-40 ... 85 °C
Approvals	CE,UL listed

<b>Dimensions</b>	
Clamping range (rating- / min. / max.)	mm²
Length x width x height	mm
<b>Note</b>	

<b>tension clamp connection</b>	
Clamping range (rating- / min. / max.)	1.5 / 0.5 / 1.5
Length x width x height	91 x 6 x 63.5
<b>Note</b>	Refer to derating curve

<b>tension clamp connection</b>	
Clamping range (rating- / min. / max.)	1.5 / 0.5 / 1.5
Length x width x height	91 x 6 x 63.5
<b>Note</b>	Refer to derating curve

**Ordering data**

<b>Version</b>			
Type	Qty.	Order No.	
MCZ OVP Gas charge eliminator 90V	10	8449130000	
<b>Note</b>			

<b>Version</b>			
Type	Qty.	Order No.	
MCZ OVP Gas charge eliminator 90V	10	8449130000	
<b>Note</b>			

<b>Version</b>			
Type	Qty.	Order No.	
MCZ OVP VARISTOR S10K30	10	8449140000	
<b>Note</b>			

**Accessories**

<b>Note</b>	End plate AP MCZ 1.5: 8389030000
-------------	-------------------------------------

<b>Note</b>	End plate AP MCZ 1.5: 8389030000
-------------	-------------------------------------

<b>Note</b>	End plate AP MCZ 1.5: 8389030000
-------------	-------------------------------------

## MC series

## 3- or 1-stage protection with tension clamp connection

- Slimline surge protection terminal with tension clamp connection
- 6 mm slimline fine surge protection
- fast wiring thanks to TS contact and tension clamp connections
- can be cross-connected using ZQV

## MCZ OVP TAZ 24 V DC

Diode unipolar



## MCZ OVP TAZ 24 V UC

Diode bipolar

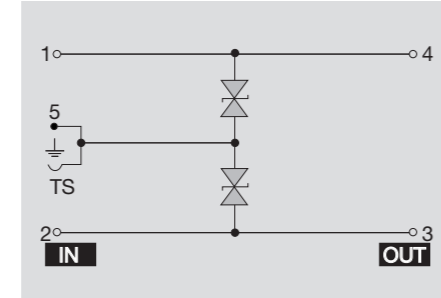
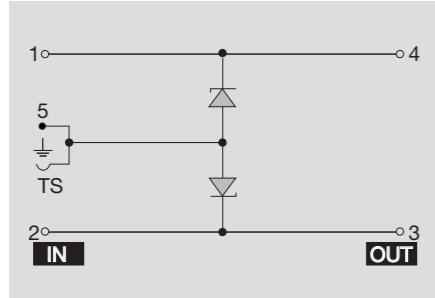

## Technical data

Rated voltage (AC)	
Rated voltage (DC)	24 V
max. continuous voltage, U <sub>c</sub> (AC)	30 V
Operating current, I <sub>max</sub>	13 A
Volume resistivity	0.20 Ω
Gas discharge tube	no
Varistor	no
Suppression diodes	yes
Cut-off frequency (-3 dB) at load impedance	
Discharge current, max. (8/20 μs)	112 A
Protection level on output side sym., input 1 kV/μs, typ.	55 V
Protection level on output side sym., input 8/20 μs, typ.	65 V
Protection level on output side unsym., input 1 kV/μs, typ.	55 V
Protection level on output side unsym., input 8/20 μs, typ.	65 V
Protection level on output side sym., input 10/350 μs, typ.	
Protection level on output side unsym., input 10/350 μs, typ.	
Lightning test voltage I <sub>imp</sub> (10/350 μs)	
Specification class to IEC 61643-21	
Design	terminal
Ambient temperature (operational)	-40 ... 60°C
Storage temperature	-40 ... 85°C
Approvals	CE,UL listed

## Dimensions

Clamping range (rating- / min. / max.)	mm <sup>2</sup>
Length x width x height	mm

## Note

## tension clamp connection

1.5 / 0.5 / 1.5
91 x 6 x 63.5

Refer to derating curve

## Ordering data

Version	Type	Qty.	Order No.
	MCZ OVP TAZ DIODE 24VDC	10	8449150000
Note			

## Accessories

Note	End plate AP MCZ 1.5: 8389030000
------	-------------------------------------

24 V

27 V

30 V

27 V

13 A

0.20 Ω

no

no

yes

112 A

55 V

65 V

55 V

65 V

## 3-stage protection with screw connection

Surge protection terminals with the tried-and-tested screw connection in the DKU series are characterised by their high level of protection concentrated in a compact design.

They are suitable for installing in the narrowest of places in automated process, industrial and building services systems. The three-stage surge protection terminals operate with gas discharge tubes, varistors, suppression diodes (TAZ) or decoupling inductances. The gas discharge tubes discharge high currents reliably; the varistors and suppression diodes absorb the residual voltages. The rated current for the DK4U and DK5U is max. 300 mA and for the DK6U max. 1 A. The DKU series comprises the DKU, DK4U, DK5U and DK6U, which are 6, 8 or 12 mm wide.

Type **DK4U** contains individual components such as varistors, gas discharge tubes or suppression diodes. Two types of varistor (MOV) are used: Type S14 is intended for lower levels of interference. It is suitable for interference protection circuits in solenoid valves or switching contacts. Type S20 is reserved for more demanding situations.

The fine gradation of the voltage varistors permits the use of all conventional rated voltages. This results in a wide range of variations. The preferred types are varistors that are used for rated voltages of 24, 48, 115 and 230 V.

Two types of gas discharge tube are used: **Gas discharge tubes** (GDT) up to 10 kA are suitable for integrating into instrumentation and control circuits, those up to 20 kA for higher signal and mains voltages.

The **suppression diodes** (Tranzorb diodes) differ in terms of voltage and are suitable for discharging small and fast transients. The tightening torque for all DKU according to IEC 947 is 0.5 Nm.

### RC combinations

RC combinations can be used as suppression circuits for contactors and solenoid valves, or for increasing the interference immunity of long AC lines. They exhibit very good properties with regard to limiting the opening surges, reducing the rate of voltage variation and shortening break times. Weidmüller RC combinations may be used in both AC and DC circuits.

### RD combinations

RD combinations are used with DC-operated equipment. Compared to a diode circuit, the resistance of the resistor / diode combination results in a shorter recovery time. RD combinations exhibit excellent suppression effects because the resistance limits the flow of current and, as a result, the

switching times are shorter. RD combinations are also less expensive than RC combinations.

If the length of the recovery time of the connected device is irrelevant, a diode circuit is preferable. If the effect on the response times of the device to be connected are to be minimised, suppression combinations with varistors or RC combination are advantageous.

### WPO 4

The Weidmüller WPO 4 terminal enables the retrofitting of electronic components like diodes, RC combinations, varistors or gas discharge tubes. As the protective elements are simply plugged in, specific protective circuits can be set up inexpensively in situ. All components are likewise easy to replace.

D



DK 4 U Varistor gas discharge tube

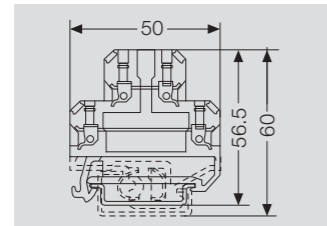

DK 4 U with suppression diode

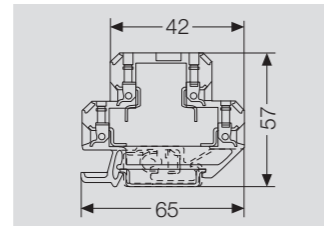

DK 5 U

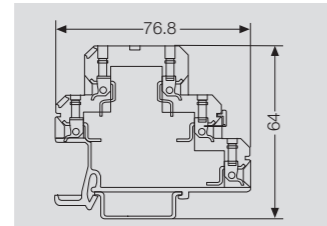

DKU with combination circuit

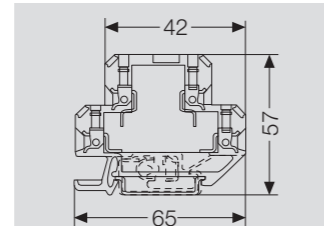

DK 6 U

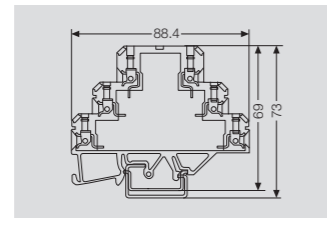



**DK series**

**3-stage protection with screw connection**

Slimline surge protection terminal with screw connection

**DKU 24 V DC 0.3 A**

Protection for binary signals

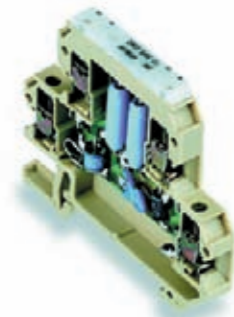

**DKU 48 V UC 0.3 A**

Protection for binary signals

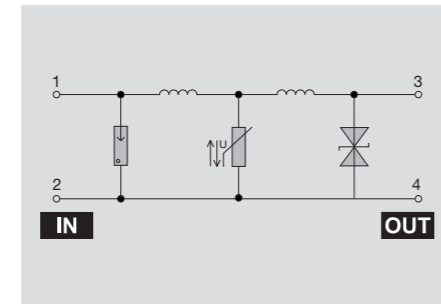
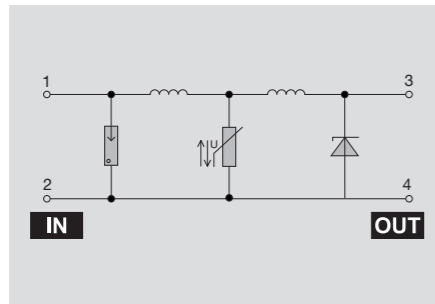

**Technical data**

<b>Technical data</b>	
Rated voltage (AC)	
Rated voltage (DC)	24 V
max. continuous voltage, U <sub>c</sub> (AC)	28 V
Operating current, I <sub>max</sub>	0.3 A
Volume resistivity	3.00 Ω
Gas discharge tube	yes
Varistor	yes
Suppression diodes	yes
Cut-off frequency (-3 dB) at load impedance	500.0 kHz 240 Ω
Discharge current, max. (8/20 μs)	5 kA
Protection level on output side sym., input 1 kV/μs, typ.	35 V
Protection level on output side sym., input 8/20 μs, typ.	45 V
Protection level on output side unsym., input 1 kV/μs, typ.	35 V
Protection level on output side unsym., input 8/20 μs, typ.	45 V
Design	terminal
Type of connection	Screw connection
Ambient temperature (operational)	-25 ... 60°C
Storage temperature	-25 ... 85°C

<b>Technical data</b>	
Rated voltage (AC)	
Rated voltage (DC)	24 V
max. continuous voltage, U <sub>c</sub> (AC)	28 V
Operating current, I <sub>max</sub>	0.3 A
Volume resistivity	3.00 Ω
Gas discharge tube	yes
Varistor	yes
Suppression diodes	yes
Cut-off frequency (-3 dB) at load impedance	500.0 kHz 240 Ω
Discharge current, max. (8/20 μs)	5 kA
Protection level on output side sym., input 1 kV/μs, typ.	35 V
Protection level on output side sym., input 8/20 μs, typ.	45 V
Protection level on output side unsym., input 1 kV/μs, typ.	35 V
Protection level on output side unsym., input 8/20 μs, typ.	45 V
Design	terminal
Type of connection	Screw connection
Ambient temperature (operational)	-25 ... 60°C
Storage temperature	-25 ... 85°C

<b>Technical data</b>	
Rated voltage (AC)	48 V
Rated voltage (DC)	48 V
max. continuous voltage, U <sub>c</sub> (AC)	54 V
Operating current, I <sub>max</sub>	0.3 A
Volume resistivity	3.00 Ω
Gas discharge tube	yes
Varistor	yes
Suppression diodes	yes
Cut-off frequency (-3 dB) at load impedance	1000.0 kHz 480 Ω
Discharge current, max. (8/20 μs)	7 kA
Protection level on output side sym., input 1 kV/μs, typ.	82 V
Protection level on output side sym., input 8/20 μs, typ.	110 V
Protection level on output side unsym., input 1 kV/μs, typ.	82 V
Protection level on output side unsym., input 8/20 μs, typ.	180 V
Design	terminal
Type of connection	Screw connection
Ambient temperature (operational)	-25 ... 60°C
Storage temperature	-25 ... 85°C

**Type of connection**

Clamping range (rating- / min. / max.)	mm <sup>2</sup>	2.5 / 0.5 / 4
Length x width x height	mm	65 x 6 x 60

Clamping range (rating- / min. / max.)	mm <sup>2</sup>	2.5 / 0.5 / 4
Length x width x height	mm	65 x 6 x 60

Clamping range (rating- / min. / max.)	mm <sup>2</sup>	2.5 / 0.5 / 4
Length x width x height	mm	65 x 6 x 60

**Note**

**Ordering data**

Type	Qty.	Order No.
DKU 35 24VDC In:0.22A	10	8015810000

Type	Qty.	Order No.
DKU 35 24VDC In:0.22A	10	8015810000

Type	Qty.	Order No.
DKU 35 48VUC In:0.22A	10	8019290000

**Note**

DKU 35 height 57mm

DKU 35 height 57mm

**Accessories**

<b>Note</b>	End plate AP DKT4 PA: 0687560000
-------------	-------------------------------------

<b>Note</b>	End plate AP DKT4 PA: 0687560000
-------------	-------------------------------------

<b>Note</b>	End plate AP DKT4 PA: 0687560000
-------------	-------------------------------------

**3-stage protection with screw connection**

Slimline surge protection terminal with screw connection

**DKU 115 V UC 0.3 A**

Protection for binary signals



**DKU 230 V UC 0.3 A**

Protection for binary signals

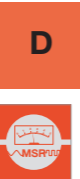
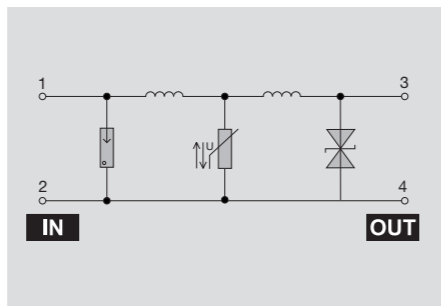
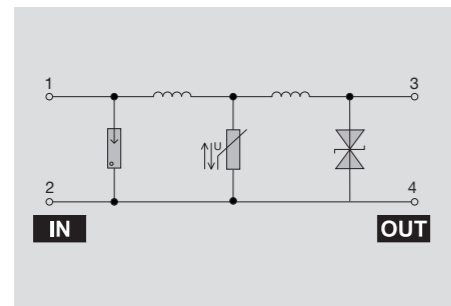

**Technical data**

<b>Technical data</b>	
Rated voltage (AC)	115 V
Rated voltage (DC)	115 V
max. continuous voltage, U <sub>c</sub> (AC)	122 V
Operating current, I <sub>max</sub>	0.3 A
Volume resistivity	3.00 Ω
Gas discharge tube	yes
Varistor	yes
Suppression diodes	yes
Cut-off frequency (-3 dB) at load impedance	1.0 MHz 50 Ω
Discharge current, max. (8/20 μs)	7 kA
Protection level on output side sym., input 1 kV/μs, typ.	180 V
Protection level on output side sym., input 8/20 μs, typ.	220 V
Protection level on output side unsym., input 1 kV/μs, typ.	180 V
Protection level on output side unsym., input 8/20 μs, typ.	220 V
Design	terminal
Type of connection	Screw connection
Ambient temperature (operational)	-25 ... 60°C
Storage temperature	-25 ... 85°C

<b>Technical data</b>	
Rated voltage (AC)	115 V
Rated voltage (DC)	115 V
max. continuous voltage, U <sub>c</sub> (AC)	122 V
Operating current, I <sub>max</sub>	0.3 A
Volume resistivity	3.00 Ω
Gas discharge tube	yes
Varistor	yes
Suppression diodes	yes
Cut-off frequency (-3 dB) at load impedance	1.0 MHz 50 Ω
Discharge current, max. (8/20 μs)	7 kA
Protection level on output side sym., input 1 kV/μs, typ.	180 V
Protection level on output side sym., input 8/20 μs, typ.	220 V
Protection level on output side unsym., input 1 kV/μs, typ.	180 V
Protection level on output side unsym., input 8/20 μs, typ.	220 V
Design	terminal
Type of connection	Screw connection
Ambient temperature (operational)	-25 ... 60°C
Storage temperature	-25 ... 85°C

<b>Technical data</b>	
Rated voltage (AC)	230 V
Rated voltage (DC)	230 V
max. continuous voltage, U <sub>c</sub> (AC)	240 V
Operating current, I <sub>max</sub>	0.3 A
Volume resistivity	3.00 Ω
Gas discharge tube	yes
Varistor	yes
Suppression diodes	yes
Cut-off frequency (-3 dB) at load impedance	1.0 MHz 2200Ω
Discharge current, max. (8/20 μs)	7 kA
Protection level on output side sym., input 1 kV/μs, typ.	400 V
Protection level on output side sym., input 8/20 μs, typ.	520 V
Protection level on output side unsym., input 1 kV/μs, typ.	400 V
Protection level on output side unsym., input 8/20 μs, typ.	520 V
Design	terminal
Type of connection	Screw connection
Ambient temperature (operational)	-25 ... 60°C
Storage temperature	-25 ... 85°C

**Type of connection**

Clamping range (rating- / min. / max.)	mm <sup>2</sup>	2.5 / 0.5 / 4
Length x width x height	mm	65 x 6 x 60

Clamping range (rating- / min. / max.)	mm <sup>2</sup>	2.5 / 0.5 / 4
Length x width x height	mm	65 x 6 x 60

Clamping range (rating- / min. / max.)	mm <sup>2</sup>	2.5 / 0.5 / 4
Length x width x height	mm	65 x 12 x 60

**Note**

**Ordering data**

Type	Qty.	Order No.
DKU 35 115VUC 0,3A	10	8019310000

Type	Qty.	Order No.
DKU 35 115VUC 0,3A	10	8019310000

Type	Qty.	Order No.
DKU 35 230VUC 0,3A	10	8019330000

**Note**

DKU 35 height 57mm

DKU 35 height 57mm

**Accessories**

<b>Note</b>	End plate AP DKT4 PA: 0687560000
-------------	-------------------------------------

<b>Note</b>	End plate AP DKT4 PA: 0687560000
-------------	-------------------------------------

<b>Note</b>	End plate AP DKT4 PA: 0687560000
-------------	-------------------------------------

**DK series**

**3-stage protection with screw connection**

Slimline surge protection terminal with screw connection

**DKU DK5 24 V DC 0.3 A**

Protection for analogue signals

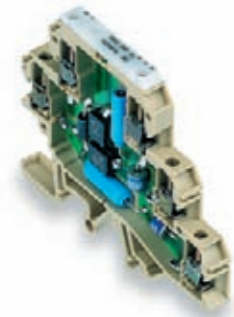

**DKU DK5 48 V UC 0.3 A**

Protection for analogue signals

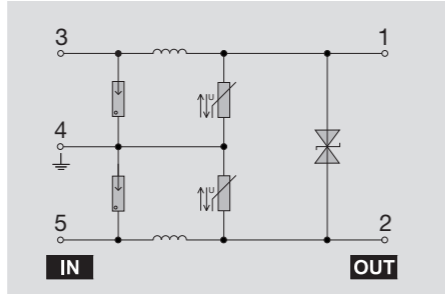
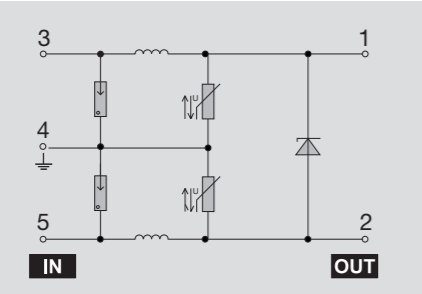

**Technical data**

<b>Technical data</b>	
Rated voltage (AC)	
Rated voltage (DC)	24 V
max. continuous voltage, U <sub>c</sub> (AC)	28 V
Operating current, I <sub>max</sub>	0.3 A
Volume resistivity	3.00 Ω
Gas discharge tube	yes
Varistor	yes
Suppression diodes	yes
Cut-off frequency (-3 dB) at load impedance	400.0 kHz 240 Ω
Discharge current, max. (8/20 μs)	5 kA
Protection level on output side sym., input 1 kV/μs, typ.	30 V
Protection level on output side sym., input 8/20 μs, typ.	45 V
Protection level on output side unsym., input 1 kV/μs, typ.	35 V
Protection level on output side unsym., input 8/20 μs, typ.	45 V
Design	terminal
Type of connection	Screw connection
Ambient temperature (operational)	-25 ... 60°C
Storage temperature	-25 ... 85°C

<b>Technical data</b>	
Rated voltage (AC)	
Rated voltage (DC)	24 V
max. continuous voltage, U <sub>c</sub> (AC)	28 V
Operating current, I <sub>max</sub>	0.3 A
Volume resistivity	3.00 Ω
Gas discharge tube	yes
Varistor	yes
Suppression diodes	yes
Cut-off frequency (-3 dB) at load impedance	400.0 kHz 240 Ω
Discharge current, max. (8/20 μs)	5 kA
Protection level on output side sym., input 1 kV/μs, typ.	30 V
Protection level on output side sym., input 8/20 μs, typ.	45 V
Protection level on output side unsym., input 1 kV/μs, typ.	35 V
Protection level on output side unsym., input 8/20 μs, typ.	45 V
Design	terminal
Type of connection	Screw connection
Ambient temperature (operational)	-25 ... 60°C
Storage temperature	-25 ... 85°C

<b>Technical data</b>	
Rated voltage (AC)	48 V
Rated voltage (DC)	48 V
max. continuous voltage, U <sub>c</sub> (AC)	54 V
Operating current, I <sub>max</sub>	0.3 A
Volume resistivity	3.00 Ω
Gas discharge tube	yes
Varistor	yes
Suppression diodes	yes
Cut-off frequency (-3 dB) at load impedance	400.0 kHz 240 Ω
Discharge current, max. (8/20 μs)	7 kA
Protection level on output side sym., input 1 kV/μs, typ.	82 V
Protection level on output side sym., input 8/20 μs, typ.	110 V
Protection level on output side unsym., input 1 kV/μs, typ.	110 V
Protection level on output side unsym., input 8/20 μs, typ.	180 V
Design	terminal
Type of connection	Screw connection
Ambient temperature (operational)	-25 ... 60°C
Storage temperature	-25 ... 85°C

**Type of connection**

Clamping range (rating- / min. / max.)	mm <sup>2</sup>	2.5 / 0.5 / 4
Length x width x height	mm	76.8 x 6 x 72

Clamping range (rating- / min. / max.)	mm <sup>2</sup>	2.5 / 0.5 / 4
Length x width x height	mm	76.8 x 6 x 72

Clamping range (rating- / min. / max.)	mm <sup>2</sup>	2.5 / 0.5 / 4
Length x width x height	mm	76.8 x 6 x 72

**Ordering data**

Type	Qty.	Order No.
DKU DK5 24VDC 0,3A	10	8238340000
<b>Note</b>		
DKU DK5 TS35, 68 mm high		

Type	Qty.	Order No.
DKU DK5 24VDC 0,3A	10	8238340000
<b>Note</b>		
DKU DK5 TS35, 68 mm high		

Type	Qty.	Order No.
DKU DK5 48VUC 0,3A	10	8262470000
<b>Note</b>		
DKU DK5 TS35, 68 mm high		

**Accessories**

<b>Note</b>	End plate AP DK5 PA BE: 4036780000
-------------	---------------------------------------

<b>Note</b>	End plate AP DK5 PA BE: 4036780000
-------------	---------------------------------------

<b>Note</b>	End plate AP DK5 PA BE: 4036780000
-------------	---------------------------------------

**3-stage protection with screw connection**

Slimline surge protection terminal with screw connection

**DKU DK6 120 V UC 1 A**

Protection for analogue signals

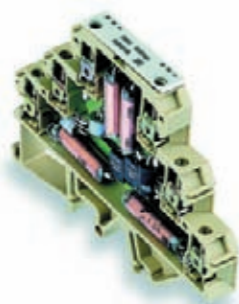

**DKU DK6 230 V UC 1 A**

Protection for analogue signals

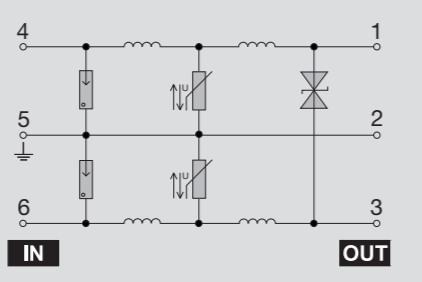
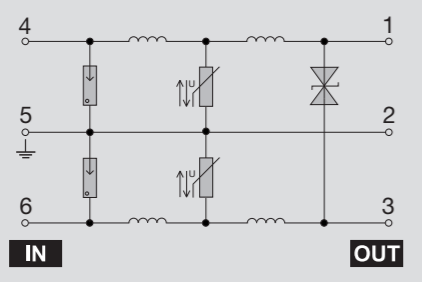
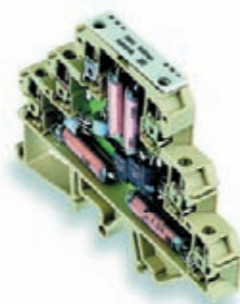

**Technical data**

<b>Technical data</b>	
Rated voltage (AC)	120 V
Rated voltage (DC)	120 V
max. continuous voltage, U <sub>c</sub> (AC)	130 V
Operating current, I <sub>max</sub>	1 A
Volume resistivity	0.30 Ω
Gas discharge tube	yes
Varistor	yes
Suppression diodes	yes
Cut-off frequency (-3 dB) at load impedance	22.0 kHz 120 Ω
Discharge current, max. (8/20 μs)	7 kA
Protection level on output side sym., input 1 kV/μs, typ.	220 V
Protection level on output side sym., input 8/20 μs, typ.	290 V
Protection level on output side unsym., input 1 kV/μs, typ.	290 V
Protection level on output side unsym., input 8/20 μs, typ.	350 V
Design	terminal
Type of connection	Screw connection
Ambient temperature (operational)	-25 ... 60°C
Storage temperature	-25 ... 85°C

Rated voltage (AC)	120 V
Rated voltage (DC)	120 V
max. continuous voltage, U <sub>c</sub> (AC)	130 V
Operating current, I <sub>max</sub>	1 A
Volume resistivity	0.30 Ω
Gas discharge tube	yes
Varistor	yes
Suppression diodes	yes
Cut-off frequency (-3 dB) at load impedance	22.0 kHz 120 Ω
Discharge current, max. (8/20 μs)	7 kA
Protection level on output side sym., input 1 kV/μs, typ.	220 V
Protection level on output side sym., input 8/20 μs, typ.	290 V
Protection level on output side unsym., input 1 kV/μs, typ.	290 V
Protection level on output side unsym., input 8/20 μs, typ.	350 V
Design	terminal
Type of connection	Screw connection
Ambient temperature (operational)	-25 ... 60°C
Storage temperature	-25 ... 85°C

Rated voltage (AC)	230 V
Rated voltage (DC)	230 V
max. continuous voltage, U <sub>c</sub> (AC)	240 V
Operating current, I <sub>max</sub>	1 A
Volume resistivity	0.30 Ω
Gas discharge tube	yes
Varistor	yes
Suppression diodes	yes
Cut-off frequency (-3 dB) at load impedance	22.0 kHz 120 Ω
Discharge current, max. (8/20 μs)	7 kA
Protection level on output side sym., input 1 kV/μs, typ.	600 V
Protection level on output side sym., input 8/20 μs, typ.	800 V
Protection level on output side unsym., input 1 kV/μs, typ.	820 V
Protection level on output side unsym., input 8/20 μs, typ.	950 V
Design	terminal
Type of connection	Screw connection
Ambient temperature (operational)	-25 ... 60°C
Storage temperature	-25 ... 85°C

**Type of connection**

Clamping range (rating- / min. / max.)	mm <sup>2</sup>	2.5 / 0.5 / 4
Length x width x height	mm	88.4 x 8 x 73

Clamping range (rating- / min. / max.)	mm <sup>2</sup>	2.5 / 0.5 / 4
Length x width x height	mm	88.4 x 8 x 73

Clamping range (rating- / min. / max.)	mm <sup>2</sup>	2.5 / 0.5 / 4
Length x width x height	mm	88.4 x 8 x 73

**Ordering data**

Type	Qty.	Order No.
DKU DK6 120VAC 1,0A	10	8262480000

Type	Qty.	Order No.
DKU DK6 120VAC 1,0A	10	8262480000

Type	Qty.	Order No.
DKU DK6 230VAC 1,0A	10	on demand

**Note**

DK6U TS35, 69 mm high

DK6U TS35, 69 mm high

**Accessories**

**Note**  
End plate  
AP DK6 PA BE: 8324560000

**Note**  
End plate  
AP DK6 PA BE: 8324560000

**Note**  
End plate  
AP DK6 PA BE: 8324560000

**DK series**

**DK-SERIES with varistor in terminal design**

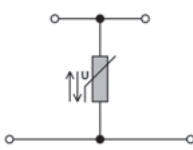

**Varistors**

Metal-oxide varistors are used as varistors. These are approved for the maximum sinusoidal operating AC voltage indicated on the component. Any voltage exceeding the indicated voltage is safely discharged. Varistors can be used for medium to large ratings.

**DK 4 U S 20 K 130**

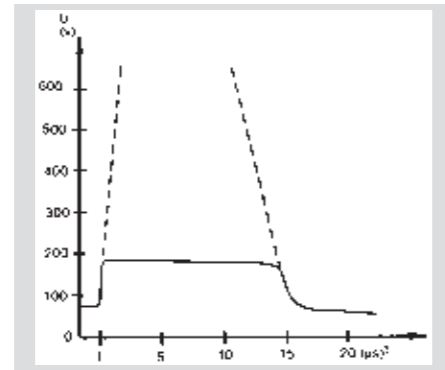

**Rated data DK 4 U**

Type	Max. operating voltage at varistor		Max. energy and surge current for 8/20 μs impulse		Max. energy and surge current for 10 000 8/20 μs impulses		Max. varistor voltage at 10 A Disch. cur.		Capacity	Order No.	
	U <sub>eff</sub>	U-	Energy J	Surge cur. A	Energy J	Surge cur. A	V	V		TS 32	TS 35
<b>S 14</b>	11	14	1,6	1000	0,07	75	36	18	18000	on request	9401400000
	14	18	2,0	1000	0,08	75	42	22	15000	on request	on request
	17	22	2,7	1000	0,11	75	52	27	10000	on request	on request
	20	26	3,3	1000	0,13	75	65	33	7500	on request	on request
	25	31	3,7	1000	0,15	75	75	39	6500	on request	9401440000
	30	38	4,4	1000	0,17	75	90	47	5500	9401050000	9401450000
	35	45	5,2	1000	0,23	75	110	56	4500	on request	on request
	40	56	6,8	1000	0,27	75	125	68	3300	on request	on request
	50	65	27,0	4500	0,6	150	135	82	2900	on request	on request
	60	85	30,0	4500	0,7	150	155	100	2400	on request	9401490000
Preferred types 24 V	75	100	38,0	4500	0,8	150	185	120	1900	on request	on request
	95	125	45,0	4500	1,0	150	230	150	1500	on request	on request
	130	170	55,0	4500	1,3	150	315	205	1000	9401120000	9401520000
	140	180	60,0	4500	1,5	150	330	220	1000	on request	on request
	150	200	65,0	4500	1,5	150	350	240	900	on request	on request
Preferred types 48 V	175	225	68,0	4500	1,6	150	420	270	750	on request	on request
	230	300	85,0	4500	2,1	150	560	360	550	on request	on request
	250	320	92,0	4500	2,4	150	610	390	500	on request	on request
	275	350	100,0	6500	2,5	190	660	430	450	9401180000	on request
	300	385	110,0	6500	2,6	190	740	470	400	on request	9401590000
<b>S 20</b>	11	14	3,0	2000	0,12	125	32	18	37000	on request	on request
	14	18	4,0	2000	0,15	125	38	22	30000	on request	on request
	17	22	5,6	2000	0,19	125	48	27	22000	on request	on request
	20	26	6,6	2000	0,24	125	60	33	17000	on request	on request
	25	31	7,8	2000	0,28	125	70	39	15000	on request	9401640000
	30	38	9,0	2000	0,35	125	85	47	13000	9401250000	9401650000
	35	45	10,8	2000	0,40	125	100	56	11000	on request	on request
	40	56	14,0	2000	0,48	125	120	68	7000	on request	on request
	50	65	36,0	6500	0,5	190	120	82	5500	on request	on request
	60	85	45,0	6500	0,7	190	150	100	4800	on request	on request
Preferred types 48 V	75	100	55,0	6500	0,8	190	180	120	3800	on request	on request
	95	125	65,0	6500	1,0	190	220	150	3000	on request	on request
	130	170	80,0	6500	1,4	190	300	205	2000	on request	on request
	140	180	90,0	6500	1,5	190	320	220	2000	on request	on request
	150	200	95,0	6500	1,6	190	340	240	1800	on request	on request
Preferred types 115 V	175	225	110,0	6500	1,8	190	390	270	1600	on request	on request
	230	300	130,0	6500	2,4	190	550	360	1200	on request	on request
	250	320	140,0	6500	2,7	190	600	390	1000	on request	on request
	275	350	150,0	8000	2,9	300	640	430	900	9401380000	9401780000
	300	385	160,0	8000	3,0	300	700	470	900	on request	on request

Overall width 12 mm

**DK 4 U with gas discharge tube or suppression diode**



The process depends on the temporal slew rate of the surge and the rated DC response voltage. The rated DC response voltage printed on the side of the gas discharge tube. Once the gas is ignited a typical arcing voltage of 10 to 30 V is produced across the component. The ionisation of the gas causes the gas discharge tube to become low resistive, allowing a high follow current to flow. Suitable measures must be taken to limit the follow current, for example, by fusing.

**Suppression diodes**

Suppression diodes work on a similar principle to conventional Zener diodes. If the indicated breakdown voltage is exceeded, the diode conducts. Compared to Zener diodes, suppression diodes have a higher current carrying capacity and faster response times in the ps range.

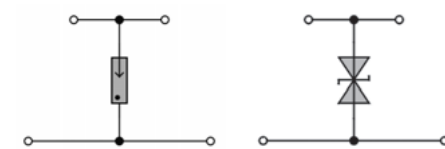

**Gas discharge tube**

The so-called gas discharge tube consists of two electrodes spaced a defined distance apart, enclosed in a small glass or ceramic tube. Between the electrodes is an inert gas at a defined pressure. A voltage surge, which has a rise time of 1 kV/μs and reaches a peak of 10 kV, can be limited to approx. 600 ... 700 V. The gas-filled space changes from high resistance to low resistance.

DK 4 U gas discharge tube 5 kA, 90 V

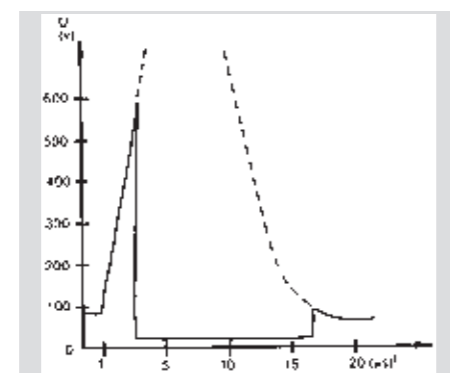

**Rated data DK 4 U**

Type	Preferred types	Tolerance		Impulse sparkover voltage at 1 kV/μs	Maximum rated voltage	Capacity	Order No. TS 32	Order No. TS 35	
		V	%						
10 kA (8/20 μs)	Preferred types 24 V	90 –	±25	< 600	35	50	≈2	on request	9400300000
	Preferred types 48 V	150 –	±15	< 600	60	90	≈2	on request	on request
		230 –	±20	< 600	95	135	≈2	on request	on request
20 kA (8/20 μs)	Preferred types 24 V	90 –	±25	< 600	35	50	≈2	9400400000	9400500000
		150 –	±15	< 600	60	90	≈2	on request	on request
	Preferred types 48 V	230 –	±15	< 650	95	135	≈2	on request	on request
	Preferred types 115 V	470 –	±15	<1000	200	280	≈2	on request	9400540000
	Preferred types 230 V	600 –	±15	<1000	255	360	≈2	on request	9400550000
DK 4 U with suppression diode	20 –	±10	< 60	–	28	≈3000	on request	8016960000	
	48 AC	±10	< 146	53	74	≈1400	on request	on request	
	115 AC	±10	< 300	135	178	≈700	on request	on request	
	230 AC	±10	< 700	320	240	≈400	on request	8017020000	
WDK 2,5 V with suppression diode	24 AC	±10	< 60	33 V	28 V	≈3000		8132760000	

**DK series**

**DK-SERIES  
with electronic components  
(other versions on request)**

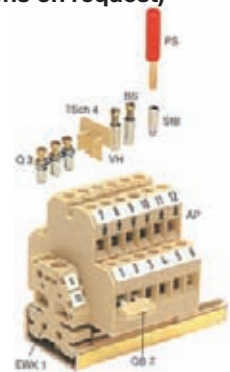

**DK 4 RC**

Arc suppression circuit for contactors and solenoid valves (AC)  
Suppressor module for optos inputs



**DK 4 RC-VDR**

Arc suppression circuit  
for contactors and solenoid valves (AC)



**Technical data**

Dimensions DK 4/WDK 2.5					
Terminal width (+ fitting tolerance 0.2)		18 mm		18 mm	
Insulation stripping length		9 mm		9 mm	
Connection data					
Screw connection, flexible	DK 4	0,5 ... 4 mm <sup>2</sup>		0,5 ... 4 mm <sup>2</sup>	
Screw connection, flexible	WDK 2.5	–		–	
Wire cross-section	DK 4	AWG 22 ... 12		AWG 22 ... 12	
Wire cross-section	WDK 2.5	–		–	
VDE rated data					
Voltage		250 V~/300 V–		24 V~/250 V	
Diode current		–		–	
Diode reverse voltage		–		–	
Current of continuous current bar		10 A		10 A	10 A
Diode		–		–	
Resistance		220 Ω		47 Ω	47 Ω
Capacitor		0,22 µF		0,22 µF	0,22 µF
Varistor	(max. operating voltage)	–		S 14	S 14
Gas discharge tube	(rated DC sparkover voltage)	–		50 V	250 V
max. discharge current	(standard wave 8/20 µs)	–		–	–
Note					

**Ordering data**

Version	Type	Order No.	Type	Varistor	Order No.
for TS 32	DK 4 RC	0692160000	DK 4 RC-VRS	50 V	on request
for TS 35	DK 4 RC/35	0053160000	DK 4 RC-VRS	50 V	on request
for TS 35	WDK 2.5 RC	8065910000	DK 4 RC-VRS/35	250 V	on request
			DK 4 RC-VRS/35	250 V	on request
Note					

**Accessories**

	Type	Qty.	Order No.	Type	Qty.	Order No.
Mounting rail (2 m lengths)	TS 32	–	0122800000	TS 32	–	0122800000
	TS 35	–	0383400000	TS 35	–	0383400000
	EWK 1 (8.5)	50	0206160000	EWK 1 (8.5)	50	0206160000
End bracket (thickness mm)	EW 35 (8.5)	50	0383560000	EW 35 (8.5)	50	0383560000
	AP PA (1.5)	20	0359260000	AP PA (1.5)	20	0359260000
End plate (thickness mm)	TSch 4	100	0363360000	TSch 4	100	0363360000
Insulation plate	SIB 8.5	50	0215700000	SIB 8.5	50	0215700000
Socket for test plug	PS (ø 2.3)	20	0180400000	PS (ø 2.3)	20	0180400000
Test plug (pin diameter)						
Cross-connection (pre-assembled)	Q 4	50	0336600000	Q 4	50	0336600000
	Q 10	20	0368600000	Q 10	20	0368600000
Cover plate	BSK M 2.5 x 18	100	0303300000	BSK M 2.5 x 18	100	0303300000
	QB 2 <sup>1)</sup>	100	0482700000	QB 2 <sup>1)</sup>	100	0482700000
Fixing screw (plastic)	QB 3 <sup>1)</sup>	50	0482800000	QB 3 <sup>1)</sup>	50	0482800000
	QB 4 <sup>1)</sup>	50	0482900000	QB 4 <sup>1)</sup>	50	0482900000
Cross-connection bridge	QB 75 blank	10	0526400000	QB 75 blank	10	0526400000
	IP	–	0526700000	IP	–	0526700000
Insulation profile	SIB 8.5	50	0215700000			
Note		1) When using QB: wire connection max. 2.5 mm <sup>2</sup>				



**DK 4 RD**

Arc suppression circuit for contactor and solenoid valves (AC)

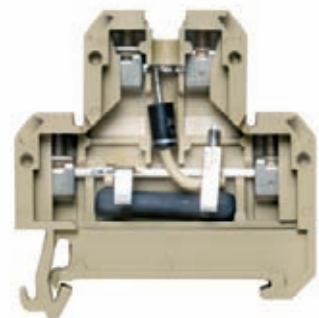

**for retrofitting electronic components**

WOP 4 with a pluggable varistor Weidmüller varistor terminals have been designed to allow the retrofitting of electronics components, e.g. varistors, diodes, gas discharge tubes, etc. These electronic terminals no longer have to be configured prior to installation and thus be delivered with soldered components which can no longer be distinguished.

The significant advantages of this new design are:

- Cost-savings
- Components can be changed quickly on site
- Service is limited to visual inspection
- Components are easy to distinguish
- Flexibility
- Components can immediately be adapted to changed conditions

12 mm
9 mm
0,5 ... 4 mm²
–
AWG 22 ... 12
–
3 A
1300 V
10 A
–
BY 255
22 Ω (4 W)
–
–
–
–

**Technical data**

**Dimensions**

Width x length x height (mm) with TS 35x7.5 V  
Insulation stripping length/clamping screw

**Rated data**

Rated voltage/current/cross-section  
Rated impulse voltage VDE 0110/1.89/pollution severity

**Further technical data**

Tightening torque range	Nm	0,5...1,0
Torque setting with DMS2 electric screwdriver clamping range		2
"e" solid HO7V-U	mm²	0,5...4
"m" stranded HO7V-R	mm²	1,5...4
"f" flexible HO7V-K	mm²	0,5...4
"f" flexible HO7V-K and AEH DIN 46228/1	mm²	0,5...4
"f" flexible HO7V-K and AEH with plastic collar	mm²	0,5...4
Plug gauge to 947-1	Size	A 3
Continuous current rating of terminal for wire size		32 A/4 mm²
Wire diameter of electrical components	mm	0,8...1,0 mm

**Note**

Type	Order No. on request
DK 4 RD	
DK 4 RD/35	0059160000

Type	Qty.	Order No.
TS 32	–	0122800000
TS 35	–	0383400000
EWK 1 (8.5)	50	0206160000
EW 35 (8.5)	50	0383560000
AP PA (1.5)	20	0359260000
TSch 4	100	0363360000
SIB 8.5	50	0215700000
PS (ø 2.3)	20	0180400000
Q 3	50	0336500000
Q 4	50	0336600000
Q 10	20	0368600000
AD 4 (4 terminals)	50	0303400000
BSK M 2.5 x 18	100	0303300000
QB 2)	100	0482700000
QB 3)	50	0482800000
QB 4)	50	0482900000
QB 75 blank	10	0526400000
IP	–	0526700000

**Ordering data**

Version	Wemid
DK 4 RD	

Intermediate frame	Thickness 1.5 mm
ZR	20

Busbar	SSch 7.3x1.2
	1m

Varistors	S14k30	S14k275
for 24 V		on request
for 230 V		on request

Gas discharge tube	90 V 20 kA	600 V 20 kA
for 90 V		on request
for 600 V		on request

Note

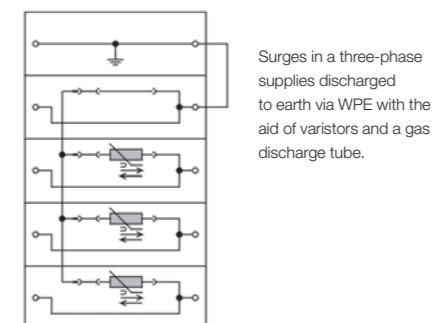

**WPO 4**

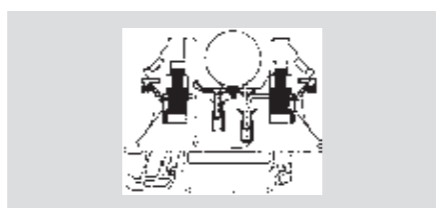

6/60/47
9 mm/M 3
250 V/32 A/4 mm²
4 kV/3
0,5...1,0
2
0,5...4
1,5...4
0,5...4
0,5...4
0,5...4
A 3
32 A/4 mm²
0,8...1,0 mm

Type	Qty	Order No.
DK 4 RD	50	1036000000

Intermediate frame	Thickness 1.5 mm
ZR	20

Busbar	SSch 7.3x1.2
	1m

Varistors	S14k30	S14k275
for 24 V		on request
for 230 V		on request

Gas discharge tube	90 V 20 kA	600 V 20 kA
for 90 V		on request
for 600 V		on request

Note

**Accessories**

Marking tags	Type	Order No.
Print		
Consecutive horizontal	DEK6 FW	on request
Consecutive vertical	DEK6 FS	on request

Note



Surge protection for instrumentation and control equipment

## 3-stage protection with screw connection

### EGU – surge protection offering excellent protection from 0.05 to 10 A

These tried-and-tested protection modules with screw connections are ideal for process, industrial and building services automation. The series comprises the **EGU1**, **EGU2**, **EGU3**, **EGU4** and **RSU** versions, all of which can be clipped onto the **TS35** and **TS32** rails. The build-in housings can be mounted in either direction by turning the base through 180°. The two- or three-stage protection offered by the EGU series operates with gas discharge tubes, varistors, suppression diodes (TAZ) and uncoupling inductances. Gas discharge tubes discharge high currents reliably. Varistors and suppression diodes absorb the residual voltages. The rated current is up to 1.5 A for the EGU types, up to 10 A for the RSU types. The products can be supplied for rated voltages of 24, 48, 115 or 230 V.

### RSU



Three-stage surge protection with GDT, MOV and suppression diode for analogue signals with high current requirement, or for power supplies in instrumentation and control installations. Available in versions for 24, 48, 115 or 230 V.

#### General technical data for RSU:

storage temperature: –25 °C ... +85 °C

operating temperature: –25 °C ... +40 °C

packed singly

### EGU1



Two-stage surge protection with GDT and MOV for binary signals, with 24, 48, 115 or 230 V, and additional fuse plus LED signal indicator.

### EGU2



Three-stage surge protection with GDT, MOV and suppression diode for binary signals, with 24, 48, 115 or 230 V, and additional fuse plus LED signal indicator.

### EGU3



Two-stage surge protection with GDT and MOV for analogue signals, with 24, 48, 115 or 230 V. Two signal lines are protected from each other and against earth with varistors.

### EGU4



Three-stage surge protection with GDT, MOV and suppression diode for analogue signals, with 24, 48, 115 or 230 V. Two signal lines are protected from each other and against earth with varistors and suppression diodes. Special versions are available, upon request, for protecting data lines.

#### General technical data for EGU:

storage temperature: –25 ... +85 °C

operating temperature: –25 ... +60 °C

packed singly

Surge protection for instrumentation and control equipment

**EGU 1 50 mA**

e.g. for binary signals

Dimensions:

L x W x H = 58 x 63 x 20 mm



Schematic circuit diagram

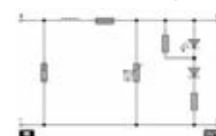

Schematic circuit diagram

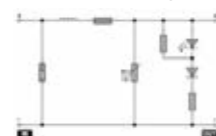

Data

Current per path, I <sub>max</sub> :	50 mA
Resistance per path, max:	28 Ω
Fuse 5x20:	F 63 mA
Model, Ingress protection class:	EG 2 IP20
Screw connection:	0.5 ... 6 mm <sup>2</sup>

**Ordering data**

<b>Type</b>	<b>Order No.</b>
EGU 1, 24 V UC	0243960000

**Technical data**

Voltage, U <sub>n</sub> 1.2:	24 V UC
Voltage, U <sub>c</sub> 1.2:	30 V AC / 38 V DC
Rated data of components	Gas discharge tube:
	90 V 5 kA
	Varistor:
	30 V
Max. frequency (-3 db/load impedance):	20 kHz / 500 Ω
Discharge current, I <sub>max</sub> (8/20 μs), typical:	6 kA
Protection level on output side, symmetric	
For 1 kV/μs pulse at input, typical:	55 V
For 8/20 μs (rated discharge current), typical:	75 V
Level of protection on output side, asymmetric:	
For 1 kV/μs pulse at input, typical:	55 V
For 8/20 μs (rated discharge current), typical:	75 V

**Technical data**

<b>Type</b>	<b>Order No.</b>
EGU 1, 48 V UC	on request
48 V UC	
60 V AC / 85 V DC	
230 V 5 kA	
110 V	
40 kHz / 1000 Ω	
6 kA	
130 V	
190 V	
130 V	
190 V	

**Technical data**

<b>Type</b>	<b>Order No.</b>
EGU 1, 115 V UC	on request
115 V UC	
130 V AC / 170 V DC	
230 V 5 kA	
130 V	
88 kHz / 2200 Ω	
6 kA	
180 V	
250 V	
180 V	
250 V	

**Technical data**

<b>Type</b>	<b>Order No.</b>
EGU 1, 230 V UC	on request
230 V UC	
250 V AC / 320 V DC	
600 V 20 kA	
275 V	
150 kHz / 4500 Ω	
24 kA	
300 V	
350 V	
300 V	
350 V	

**EGU 2 50 mA**

e.g. for binary signals

Dimensions:

L x W x H = 58 x 63 x 20 mm



Schematic circuit diagram

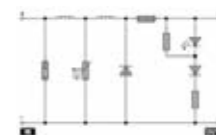

Schematic circuit diagram

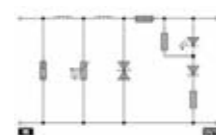

Data

Current per path, I <sub>max</sub> :	50 mA
Resistance per path, max:	28 Ω
Fuse 5x20:	F 63 mA
Model, Ingress protection class:	EG 2 IP20
Screw connection:	0.5 ... 6 mm <sup>2</sup>

**Ordering data**

<b>Type</b>	<b>Order No.</b>
EGU 2, 24 V DC	0223060000

**Technical data**

Voltage, U <sub>n</sub> 1.2:	24 V DC
Voltage, U <sub>c</sub> 1.2:	28 V DC
Rated data of components	Gas discharge tube:
	90 V 5 kA
	Varistor:
	30 V
	Suppression diode:
	33 V
Max. frequency (-3 db/load impedance):	10 kHz / 500 Ω
Discharge current, I <sub>max</sub> (8/20 μs) typical:	6 kA
Protection level on output side, symmetric	
For 1 kV/μs pulse at input, typical:	35 V
For 8/20 μs (rated discharge current), typical:	75 V
Level of protection on output side, asymmetric:	
For 1 kV/μs pulse at input, typical:	55 V
For 8/20 μs (rated discharge current), typical:	75 V

**Technical data**

<b>Type</b>	<b>Order No.</b>
EGU 2, 48 V UC	on request
48 V UC	
55 V AC / 88 V DC	
230 V 5 kA	
150 V	
86 V	
20 kHz / 500 Ω	
6 kA	
82 V	
120 V	
82 V	
120 V	

**Technical data**

<b>Type</b>	<b>Order No.</b>
EGU 2, 115 V UC	on request
115 V UC	
130 V AC / 170 V DC	
230 V 5 kA	
150 V	
170 V	
88 kHz / 2200 Ω	
6 kA	
230 V	
350 V	
230 V	
350 V	

**Technical data**

<b>Type</b>	<b>Order No.</b>
EGU 2, 230 V UC	0223260000
230 V UC	
250 V AC / 320 V DC	
600 V 20 kA	
275 V	
264 V	
150 kHz / 4500 Ω	
24 kA	
600 V	
820 V	
600 V	
820 V	

**EGU 2 1.5 A**

e.g. for power supplies

Dimensions:

L x W x H = 58 x 63 x 20 mm



Schematic circuit diagram

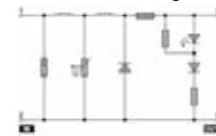

Schematic circuit diagram



Data

Current per path, I <sub>max</sub> :	1.5 A
Resistance per path, max:	0.2 Ω
Fuse 5x20:	F 1.6 A
Model, Ingress protection class:	EG 2 IP20
Screw connection:	0.5 ... 6 mm <sup>2</sup>

**Ordering data**

<b>Type</b>	<b>Order No.</b>
EGU 2, 24 V DC	9310830000

**Technical data**

Voltage, U <sub>n</sub> 1.2:	24 V DC
Voltage, U <sub>c</sub> 1.2:	28 V DC
Rated data of components	Gas discharge tube:
	90 V 5 kA
	Varistor:
	30 V
	Suppression diode:
	33 V
Max. frequency (-3 db/load impedance):	500 kHz / 16 Ω
Discharge current, I <sub>max</sub> (8/20 μs) typical:	6 kA
Protection level on output side, symmetric	
For 1 kV/μs pulse at input, typical:	35 V
For 8/20 μs (rated discharge current), typical:	45 V
Level of protection on output side, asymmetric:	
For 1 kV/μs pulse at input, typical:	55 V
For 8/20 μs (rated discharge current), typical:	75 V

**Technical data**

<b>Type</b>	<b>Order No.</b>
EGU 2, 48 V UC	1170160000
48 V UC	
55 V AC / 88 V DC	
230 V 5 kA	
150 V	
86 V	
1 MHz / 32 Ω	
6 kA	
82 V	
120 V	
82 V	
120 V	

**Technical data**

<b>Type</b>	<b>Order No.</b>
EGU 2, 115 V UC	on request
115 V UC	
130 V AC / 170 V DC	
230 V 5 kA	
150 V	
170 V	
1.5 MHz / 70 Ω	
6 kA	
230 V	
350 V	
230 V	
350 V	

**Technical data**

<b>Type</b>	<b>Order No.</b>
EGU 2, 230 V UC	on request
230 V UC	
250 V AC / 320 V DC	
600 V 20 kA	
275 V	
264 V	
2 MHz / 150 Ω	
24 kA	
600 V	
820 V	
600 V	
820 V	

## EG series

## EGU 3 50 mA

e.g. for current loops

Dimensions:

L x W x H = 58 x 95 x 22.5 mm



## Schematic circuit diagram

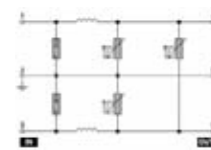

## Schematic circuit diagram

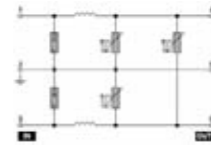

## Data

Current per path, I <sub>max</sub> :	50 mA
Resistance per path, max:	18 Ω
Model, Ingress protection class	EG 3 IP20
Screw connection:	0,5 ... 4 mm <sup>2</sup>

Ordering data	Type	Order No.	Type	Order No.	Type	Order No.	Type	Order No.
	EGU 3, 24 V UC	<b>0250560000</b>	EGU 3, 48 V UC	<b>0250660000</b>	EGU 3, 115 V UC	<b>9311530000</b>	EGU 3, 230 V UC	<b>0250860000</b>
<b>Technical data</b>								
Voltage, U <sub>n</sub> 1.3:	24 V UC		48 V UC		115 V UC		230 V UC	
Voltage, U <sub>c</sub> 1.3:	30 V AC / 38 V DC		60 V AC / 85 V DC		130 V AC / 170 V DC		250 V AC / 320 V DC	
Rated data of components	Gas discharge tube:	90 V 5 kA	230 V 5 kA	230 V 5 kA	230 V 5 kA		600 V 20 kA	
	Varistor:	30 V	65 V	180 V	180 V		275V	
	Max. frequency (-3 db/load impedance):	10 kHz / 500 Ω	20 kHz / 1000 Ω	44 kHz / 2200 Ω	44 kHz / 2200 Ω		75 kHz / 4500 Ω	
	Discharge current, I <sub>max</sub> (8/20 μs), typical:	6 kA	6 kA	6 kA	6 kA		24 kA	
Protection level on output side, symmetric:								
	For 1 kV/μs pulse at input, typical:	55 V	130 V	180 V	180 V		300 V	
	For 8/20 μs (rated discharge current), typical:	75 V	150 V	220 V	220 V		350 V	
Level of protection on output side, asymmetric:								
	For 1 kV/μs pulse at input, typical:	85 V	150 V	230 V	230 V		400 V	
	For 8/20 μs (rated discharge current), typical:	105 V	190 V	290 V	290 V		430 V	

## EGU 3 1.5 A

e.g. for power supplies

Dimensions:

L x W x H = 58 x 95 x 22.5 mm



## Schematic circuit diagram

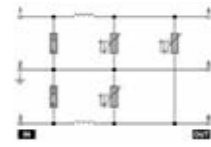

## Schematic circuit diagram

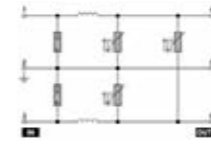

## Data

Current per path, I <sub>max</sub> :	1,5 A
Resistance per path, max:	0,1 Ω
Model, Ingress protection class	EG 3 IP20
Screw connection:	0,5 ... 4 mm <sup>2</sup>

Ordering data	Type	Order No.	Type	Order No.	Type	Order No.	Type	Order No.
	EGU 3, 24 V UC	<b>1186760000</b>	EGU 3, 48 V UC	<b>1186960000</b>	EGU 3, 115 V UC	<b>on request</b>	EGU 3, 230 V UC	<b>1187060000</b>
<b>Technical data</b>								
Voltage, U <sub>n</sub> 1.3:	24 V UC		48 V UC		115 V UC		230 V UC	
Voltage, U <sub>c</sub> 1.3:	30 V AC / 38 V DC		60 V AC / 85 V DC		130 V AC / 170 V DC		240 V AC / 315 V DC	
Rated data of components	Gas discharge tube:	90 V 5 kA	230 V 5 kA	230 V 5 kA	230 V 5 kA		600 V 20 kA	
	Varistor:	30 V	65 V	180 V	180 V		275 V	
	Max. frequency (-3 db/load impedance):	300 kHz / 16 Ω	400 kHz / 32 Ω	550 kHz / 70 Ω	550 kHz / 70 Ω		800 kHz / 150 Ω	
	Discharge current, I <sub>max</sub> (8/20 μs), typical:	6 kA	6 kA	6 kA	6 kA		24 kA	
Protection level on output side, symmetric:								
	For 1 kV/μs pulse at input, typical:	55 V	130 V	180 V	180 V		300 V	
	For 8/20 μs (rated discharge current), typical:	75 V	150 V	220 V	220 V		350 V	
Level of protection on output side, asymmetric:								
	For 1 kV/μs pulse at input, typical:	85 V	150 V	230 V	230 V		400 V	
	For 8/20 μs (rated discharge current), typical:	105 V	190 V	290 V	290 V		430 V	

## EGU 4 0.1 A

e.g. for current loops

Dimensions:

L x W x H = 58 x 95 x 22.5 mm



## Schematic circuit diagram

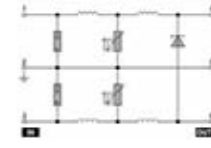

## Schematic circuit diagram

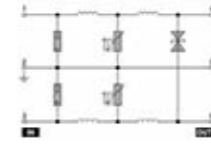

## Data

Current per path, I <sub>max</sub> :	100 mA
Resistance per path, max:	22 Ω
Model, Ingress protection class	EG 3 IP20
Screw connection:	0,5 ... 4 mm <sup>2</sup>

Ordering data	Type	Order No.	Type	Order No.	Type	Order No.	Type	Order No.
	EGU 4, 24 V DC	<b>0459460000</b>	EGU 4, 48 V UC	<b>0461860000</b>	EGU 4, 115 V UC	<b>on request</b>	EGU 4, 230 V UC	<b>0462060000</b>
<b>Technical data</b>								
Voltage, U <sub>n</sub> 1.3:	24 V DC		48 V UC		115 V UC		230 V UC	
Voltage, U <sub>c</sub> 1.3:	28 V DC		55 V AC / 34 V DC		130 V AC / 170 V DC		250 V AC / 320 V DC	
Rated data of components	Gas discharge tube:	90 V 5 kA	150 V 5 kA	150 V 5kA	150 V 5kA		600 V 20 kA	
	Varistor:	30 V	55 V	75 V	75 V		275 V	
	Suppression diode:	33 V	48 V	120 V	120 V		240 V	
	Max. frequency (-3 db/load impedance):	5 kHz / 240 Ω	10 kHz / 240 Ω	20 kHz / 1200 Ω	20 kHz / 1200 Ω		1 MHz / 150 kΩ	
	Discharge current, I <sub>max</sub> (8/20 μs), typical:	6 kA	6 kA	6 kA	6 kA		24 kA	
Protection level on output side, symmetric:								
	For 1 kV/μs pulse at input, typical:	33 V	82 V	200 V	200 V		350 V	
	For 8/20 μs (rated discharge current), typical:	45 V	130 V	250 V	250 V		420 V	
Protection level on output side, asymmetric:								
	For 1 kV/μs pulse at input, typical:	48 V	110 V	310 V	310 V		390 V	
	For 8/20 μs (rated discharge current), typical:	90 V	150 V	350 V	350 V		480 V	

**EGU 4 1.5 A**

e.g. for power supplies

Dimensions:  
L x W x H = 58 x 95 x 22.5 mm



Schematic circuit diagram

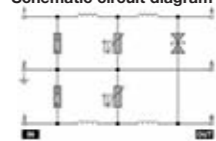

Schematic circuit diagram

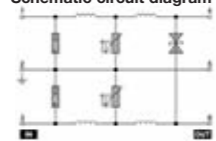

Data

Current per path, I <sub>max</sub> :	1.5 A
Resistance per path, max:	0,1 Ω
Model, Ingress protection class	EG 3 IP20
Screw connection:	0,5 ... 4 mm <sup>2</sup>

**Ordering data**

Type	Order No.
------	-----------

**Type**

EGU 4, 24 V UC	<b>1170960000</b>
----------------	-------------------

**Type**

EGU 4, 48 V UC	<b>on request</b>
----------------	-------------------

**Type**

EGU 4, 115 V UC	<b>1171160000</b>
-----------------	-------------------

**Type**

EGU 4, 230 V UC	<b>1171260000</b>
-----------------	-------------------

**Technical data**

Voltage, U <sub>n</sub> 1.3:	24 V UC	
Voltage, U <sub>c</sub> 1.3:	34 V AC / 26.5 V DC	
Rated data of components	Gas discharge tube:	90 V 5 kA
	Varistor:	30 V
	Suppression diode:	33 V
Max. frequency (-3 db/load impedance):	250 kHz / 16 Ω	
Discharge current, I <sub>max</sub> (8/20 μs), typical:	6 kA	
Protection level on output side, symmetric:		
For 1 kV/μs pulse at input, typical:	33 V	
For 8/20 μs (rated discharge current), typical:	45 V	
Protection level on output side, asymmetric:		
For 1 kV/μs pulse at input, typical:	48 V	
For 8/20 μs (rated discharge current), typical:	90 V	

**Type**

24 V UC
34 V AC / 26.5 V DC
90 V 5 kA
30 V
33 V
250 kHz / 16 Ω
6 kA
33 V
45 V
48 V
90 V

**Type**

48 V UC
53 V AC / 75 V DC
230 V 5 kA
55 V
48 V
500 kHz / 32 Ω
6 kA
82 V
130 V
110 V
150 V

**Type**

115 V UC
130 V AC / 170 V DC
230 V 5kA
75 V
120 V
800 kHz / 70 kΩ
6 kA
200 V
250 V
310 V
350 V

**Type**

230 V UC
250 V AC / 320 V DC
600 V 20 kA
275 V
240 V
1 Mhz / 150 kΩ
24 kA
400 V
420 V
390 V
480 V

**EGU 4 0.1 A**

e.g. for symmetric loads

Dimensions:  
L x W x H = 58 x 95 x 22.5 mm



Schematic circuit diagram

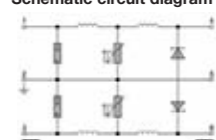

Schematic circuit diagram

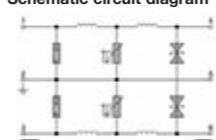

Data

Current per path, I <sub>max</sub> :	100 mA
Resistance per path, max:	12 Ω
Model, Ingress protection class	EG 3 IP20
Screw connection:	0,5 ... 4 mm <sup>2</sup>

**Ordering data**

Type	Order No.
------	-----------

**Type**

EGU 4, 24 V DC	<b>1170560000</b>
----------------	-------------------

**Type**

EGU 4, 48 V UC	<b>on request</b>
----------------	-------------------

**Type**

EGU 4, 115 V UC	<b>on request</b>
-----------------	-------------------

**Type**

EGU 4, 230 V UC	<b>on request</b>
-----------------	-------------------

**Technical data**

Voltage, U <sub>n</sub> 1.3:	24 V DC	
Voltage, U <sub>c</sub> 1.3:	31 V DC	
Rated data of components	Gas discharge tube:	90 V 5 kA
	Varistor:	30 V
	Suppression diode:	33 V
Max. frequency (-3 db/load impedance):	5 kHz / 240 Ω	
Discharge current, I <sub>max</sub> (8/20 μs), typical:	6 kA	
Protection level on output side, symmetric:		
For 1 kV/μs pulse at input, typical:	33 V	
For 8/20 μs (rated discharge current), typical:	45 V	
Protection level on output side, asymmetric:		
For 1 kV/μs pulse at input, typical:	66 V	
For 8/20 μs (rated discharge current), typical:	110 V	

**Type**

24 V DC
31 V DC
90 V 5 kA
30 V
33 V
5 kHz / 240 Ω
6 kA
33 V
45 V
66 V
110 V

**Type**

48 V UC
55 V AC / 75 V DC
230 V 5 kA
55 V
48 V
20 kHz / 480 Ω
6 kA
82 V
130 V
170 V
190 V

**Type**

115 V UC
130 V AC / 170 V DC
230 V 5 kA
75 V
120 V
40 kHz / 1200 Ω
6 kA
200 V
250 V
400 V
480 V

**Type**

230 V UC
250 V AC / 320 V DC
600 V 20 kA
275 V
240 V
80 khz / 2,2 kΩ
24 kA
350 V
420 V
700 V
880 V



**JACKPAC®**

**1-stage surge protection**

The surge protection is plugged in to protect the sensitive electronics in the signalling circuit.

The suppression circuit with varistor suppresses the induced voltage in solenoid valves.

The PE connection leaves the housing via a separate line. The green/yellow earthing cable must be connected to the system earth to ensure reliable discharge of interference pulses.

**JPOVP 24 V DC MOV M12**

Suppression circuit with diode

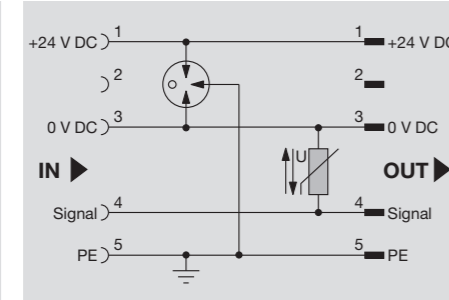

**JPOVP Cat.5 M12**

Ethernet Cat.5

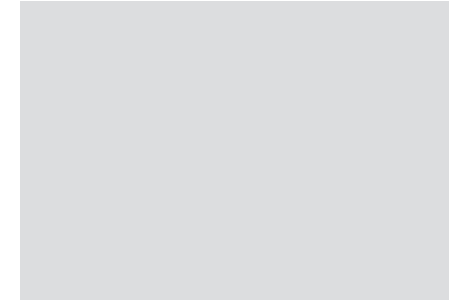
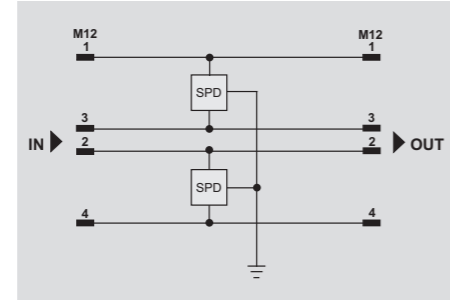

**Technical data**

Technical data	
Rated voltage	24 V DC
Operating voltage (DC), max.	28 V
Rated discharge current per path (8/20 µs)	5 kA
Total discharge current, max. (8/20 µs)	10 kA
DC response voltage	90 V
Attenuation	-
Response time	≤ 25 ns
Rated current	2 A
Protection level, signal line, wire to wire/PE	230 V/230 V
Protection level, supply, wire to wire/PE	85 V/85 V
Leakage current at Un	1 µA
General data	
Operating temperature	-25 ... 60°C
Surge category	II
Pollution severity	2
Type of connection	M12 - plug/socket, A-coded
Approvals	CE

Rated voltage	24 V DC
Operating voltage (DC), max.	28 V
Rated discharge current per path (8/20 µs)	5 kA
Total discharge current, max. (8/20 µs)	10 kA
DC response voltage	90 V
Attenuation	-
Response time	≤ 25 ns
Rated current	2 A
Protection level, signal line, wire to wire/PE	230 V/230 V
Protection level, supply, wire to wire/PE	85 V/85 V
Leakage current at Un	1 µA
General data	
Operating temperature	-25 ... 60°C
Surge category	II
Pollution severity	2
Type of connection	M12 - plug/socket, A-coded
Approvals	CE

Rated voltage	30 V AC/DC
Operating voltage (DC), max.	30 V
Rated discharge current per path (8/20 µs)	5 kA
Total discharge current, max. (8/20 µs)	10 kA
DC response voltage	230 V
Attenuation	< 0.3 dB at 250 Hz
Response time	≤ 5 ns
Rated current	0.2 A
Protection level, signal line, wire to wire/PE	130 V/600 V
Protection level, supply, wire to wire/PE	80 V/300 V
General data	
Operating temperature	-25 ... 60°C
Surge category	III
Pollution severity	2
Type of connection	to IEC 61076-2-101-A1;M12 - plug/plug, D-coded
Approvals	CE

**Dimensions**

Clamping range (rating- / min. / max.)	mm²
Length x width x height	mm

Clamping range (rating- / min. / max.)	mm²
Length x width x height	83 x 36 x 14.4

Clamping range (rating- / min. / max.)	mm²
Length x width x height	57 x 36 x 14.4

Note	
------	--

Note	
------	--

Note	Each cable 1.5 m long
------	-----------------------

**Ordering data**

Type	Qty.	Order No.
JPOVP 24VDC MOV M12	1	8760960000

Type	Qty.	Order No.
JPOVP 24VDC MOV M12	1	8760960000

Type	Qty.	Order No.
JPOVP M12 D-coded Cat5	1	8805570000

Note	
------	--

Note	
------	--

Note	
------	--

**Accessories**

Note	Retaining clip JP CLIP M 8778490000
------	--

Note	Retaining clip JP CLIP M 8778490000
------	--

Note	Retaining clip JP CLIP M 8778490000
------	--



**1-stage surge protection**

Jackpac OVP terminal equipment against the overvoltages that can occur as a result of atmospheric discharges or storms. This type of protection in the form of an adapter is available in IP20 and IP67 versions and complies with the requirements of class III to IEC 61643-21.

**JPOVP Cat.6 IP20**

Ethernet Cat.6

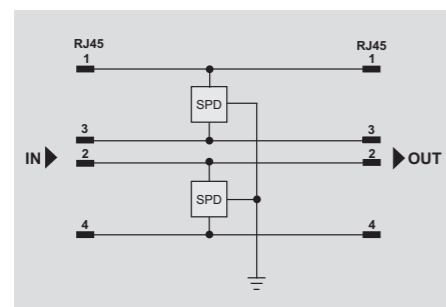

**JPOVP Cat.6 IP67**

Ethernet Cat.6

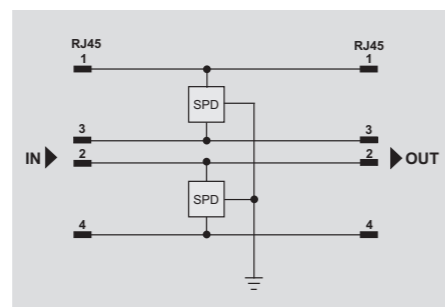

**Technical data**

<b>Technical data</b>	
Rated voltage	34 V AC / 48 V DC
Operating voltage (DC), max.	48 V
Rated discharge current per path (8/20 µs)	5 kA
Total discharge current, max. (8/20 µs)	10 kA
DC response voltage	230 V
Attenuation	< 0.3 dB at 250 Hz
Response time	≤ 5 ns
Rated current	0.2 A
Protection level, signal line, wire to wire/PE	130 V/600 V
Protection level, supply, wire to wire/PE	80 V/300 V
Leakage current at Un	

<b>Technical data</b>	
Rated voltage	34 V AC / 48 V DC
Operating voltage (DC), max.	48 V
Rated discharge current per path (8/20 µs)	5 kA
Total discharge current, max. (8/20 µs)	10 kA
DC response voltage	230 V
Attenuation	< 0.3 dB at 250 Hz
Response time	≤ 5 ns
Rated current	0.2 A
Protection level, signal line, wire to wire/PE	130 V/600 V
Protection level, supply, wire to wire/PE	80 V/300 V
Leakage current at Un	

<b>Technical data</b>	
Rated voltage	34 V AC / 48 V DC
Operating voltage (DC), max.	48 V
Rated discharge current per path (8/20 µs)	5 kA
Total discharge current, max. (8/20 µs)	10 kA
DC response voltage	230 V
Attenuation	< 0.3 dB at 250 Hz
Response time	≤ 5 ns
Rated current	0.2 A
Protection level, signal line, wire to wire/PE	130 V/600 V
Protection level, supply, wire to wire/PE	80 V/300 V
Leakage current at Un	

<b>General data</b>	
Operating temperature	-25 ... 60°C
Surge category	III
Pollution severity	2
Type of connection	RJ45 plug; IP 20
Approvals	CE

<b>General data</b>	
Operating temperature	-25 ... 60°C
Surge category	III
Pollution severity	2
Type of connection	RJ45 plug; IP 20
Approvals	CE

<b>General data</b>	
Operating temperature	-25 ... 60°C
Surge category	III
Pollution severity	2
Type of connection	RJ45 plug; IP 67
Approvals	CE

<b>Dimensions</b>	
Clamping range (rating- / min. / max.)	mm²
Length x width x height	mm

<b>Dimensions</b>	
Clamping range (rating- / min. / max.)	mm²
Length x width x height	mm

<b>Dimensions</b>	
Clamping range (rating- / min. / max.)	mm²
Length x width x height	mm

**Note**

each with 1.5 m cable

each with 1 m cable and IP67 cable gland

**Ordering data**

Type	Qty.	Order No.
JPOVP RJ45 Cat6 IP20	1	8805550000

Type	Qty.	Order No.
JPOVP RJ45 Cat6 IP20	1	8805550000

Type	Qty.	Order No.
JPOVP RJ45 Cat6 IP67	1	8805560000

**Note**

**Accessories**

<b>Note</b>	Retaining clip JP CLIP M 8778490000
-------------	--

<b>Note</b>	Retaining clip JP CLIP M 8778490000
-------------	--

<b>Note</b>	Retaining clip JP CLIP M 8778490000
-------------	--





## JACKPAC®

### 3-stage surge protection

With gas discharge tube, varistor and suppression diode.

For protecting binary switching signals up to 24 V, or for analogue measuring circuits with 0...20 mA or 0...10 V.

The PE connection leaves the housing via a separate line. The green/yellow cable must be securely connected to the systems earth to ensure reliable discharging of interference pulses.

### JPOVP 24 V DC ANA M12

for analogue signals

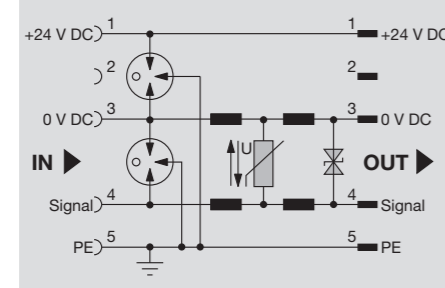

### JPOVP 24 V DC BIN M12

for digital signals

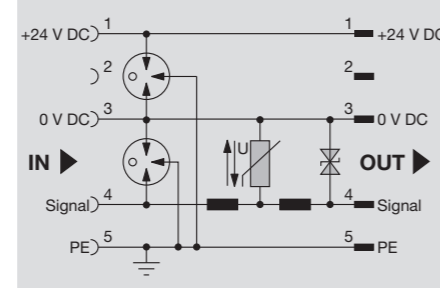

### Technical data

Technical data	
Rated voltage	24 V DC
Operating voltage (DC), max.	28 V
Rated discharge current per path (8/20 µs)	5 kA
Total discharge current, max. (8/20 µs)	10 kA
DC response voltage	90 V
Varistor	30 V
Suppression diodes	yes
Response time	≤ 100 ps
Rated current	2 A
Protection level, signal line, wire to wire/PE	45 V/65 V
Protection level, supply, wire to wire/PE	85 V/85 V
Leakage current at Un	1 µA

General data	
Operating temperature	-25 ... 60°C
Surge category	II
Pollution severity	2
Type of connection	M12 - plug/socket, A-coded
Approvals	CE

Dimensions	
Clamping range (rating- / min. / max.)	mm²
Length x width x height	mm

Note	

### Ordering data

Type	Qty.	Order No.
JPOVP 24VDC ANA M12	1	8760970000

Note	

### Accessories

Note	
Retaining clip JP CLIP M 8778490000	

24 V DC
28 V
5 kA
10 kA
90 V
30 V
yes
≤ 100 ps
2 A
45 V/65 V
85 V/85 V
1 µA

-25 ... 60°C
II
2
M12 - plug/socket, A-coded
CE

83 x 36 x 14
--------------

83 x 36 x 14
--------------

Type	Qty.	Order No.
JPOVP 24VDC BIN M12	1	8760980000

Note	

Retaining clip JP CLIP M 8778490000
--



**RS series**

**3-stage protection with screw connection**

- Surge protection RSU for power supplies
- with current-compensated inductor
- low residual voltage thanks to suppression diodes

**RSU 24 V UC 6 A**



**RSU 115 V UC 6 A**

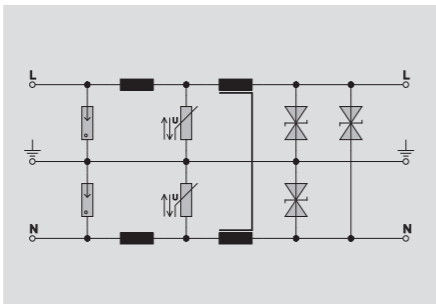
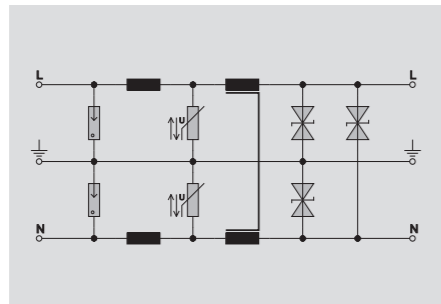

**Technical data**

<b>Technical data</b>	
Rated voltage (AC)	24 V
Rated voltage (DC)	24 V
max. continuous voltage, U <sub>c</sub> (AC)	27 V
Operating current, I <sub>max</sub>	6 A
Volume resistivity	0.08 Ω
Gas discharge tube	yes
Varistor	yes
Suppression diodes	yes
Cut-off frequency (-3 dB) at load impedance	8.0 kHz 4 Ω
Discharge current, max. (8/20 μs)	24 kA
Protection level on output side sym., input 1 kV/μs, typ.	40 V
Protection level on output side sym., input 8/20 μs, typ.	45 V
Protection level on output side unsym., input 1kV/μs, typ.	40 V
Protection level on output side unsym., input 8/20 μs, typ.	45 V
Design	RS section
Type of connection	Screw connection
Ambient temperature (operational)	-25 ... 40°C
Storage temperature	-25 ... 85°C

<b>Technical data</b>	
Rated voltage (AC)	24 V
Rated voltage (DC)	24 V
max. continuous voltage, U <sub>c</sub> (AC)	27 V
Operating current, I <sub>max</sub>	6 A
Volume resistivity	0.08 Ω
Gas discharge tube	yes
Varistor	yes
Suppression diodes	yes
Cut-off frequency (-3 dB) at load impedance	8.0 kHz 4 Ω
Discharge current, max. (8/20 μs)	24 kA
Protection level on output side sym., input 1 kV/μs, typ.	40 V
Protection level on output side sym., input 8/20 μs, typ.	45 V
Protection level on output side unsym., input 1kV/μs, typ.	40 V
Protection level on output side unsym., input 8/20 μs, typ.	45 V
Design	RS section
Type of connection	Screw connection
Ambient temperature (operational)	-25 ... 40°C
Storage temperature	-25 ... 85°C

<b>Technical data</b>	
Rated voltage (AC)	115 V
Rated voltage (DC)	115 V
max. continuous voltage, U <sub>c</sub> (AC)	130 V
Operating current, I <sub>max</sub>	6 A
Volume resistivity	0.08 Ω
Gas discharge tube	yes
Varistor	yes
Suppression diodes	yes
Cut-off frequency (-3 dB) at load impedance	30.0 kHz 20 Ω
Discharge current, max. (8/20 μs)	24 kA
Protection level on output side sym., input 1 kV/μs, typ.	200 V
Protection level on output side sym., input 8/20 μs, typ.	250 V
Protection level on output side unsym., input 1kV/μs, typ.	200 V
Protection level on output side unsym., input 8/20 μs, typ.	250 V
Design	RS section
Type of connection	Screw connection
Ambient temperature (operational)	-25 ... 40°C
Storage temperature	-25 ... 70°C

**Type of connection**

Clamping range (rating- / min. / max.)	mm <sup>2</sup>	2.5 / 0.5 / 4
Length x width x height	mm	87 x 81 x 89

Clamping range (rating- / min. / max.)	mm <sup>2</sup>	2.5 / 0.5 / 4
Length x width x height	mm	87 x 81 x 89

Clamping range (rating- / min. / max.)	mm <sup>2</sup>	2.5 / 0.5 / 4
Length x width x height	mm	87 x 81 x 89

**Note**

**Ordering data**

Type	Qty.	Order No.
RSU 24VUC 6A LP	1	1171361001

Type	Qty.	Order No.
RSU 24VUC 6A LP	1	1171361001

Type	Qty.	Order No.
RSU 115VUC 6A	1	1171561001

**Note**

**Accessories**

**Note**

**3-stage protection with screw connection**

- Surge protection RSU for power supplies
- with current-compensated inductor
- low residual voltage thanks to suppression diodes

**RSU 230 V UC 6 A**

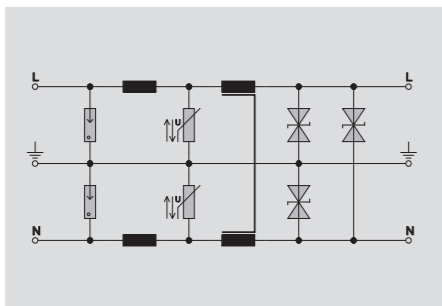

**Technical data**

Technical data	
Rated voltage (AC)	230 V
Rated voltage (DC)	230 V
max. continuous voltage, U <sub>c</sub> (AC)	250 V
Operating current, I <sub>max</sub>	6 A
Volume resistivity	0.08 Ω
Gas discharge tube	yes
Varistor	yes
Suppression diodes	yes
Cut-off frequency (-3 dB) at load impedance	90.0 kHz 40 kΩ
Discharge current, max. (8/20 μs)	24 kA
Protection level on output side sym., input 1 kV/μs, typ.	400 V
Protection level on output side sym., input 8/20 μs, typ.	420 V
Protection level on output side unsym., input 1kV/μs, typ.	400 V
Protection level on output side unsym., input 8/20 μs, typ.	420 V
Design	RS section
Type of connection	Screw connection
Ambient temperature (operational)	-25 ... 40°C
Storage temperature	-25 ... 70°C

Type of connection	
Clamping range (rating- / min. / max.)	mm <sup>2</sup> 2.5 / 0.5 / 4
Length x width x height	mm 87 x 81 x 89

Note	

**Ordering data**

Type	Qty.	Order No.
RSU 230VUC 6A LP	1	1171661001

Note	

**Accessories**

Note	



**RS series**

**3-stage protection with screw connection**

- Surge protection RSU for power supplies
- with current-compensated inductor
- low residual voltage thanks to suppression diodes

**RSU 24 V UC 10 A**



**RSU 115 V UC 10 A**

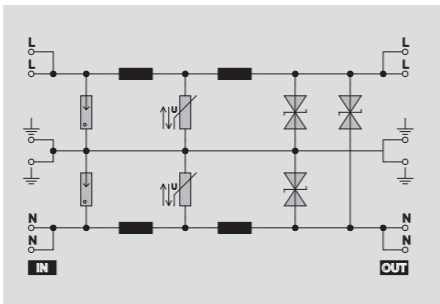
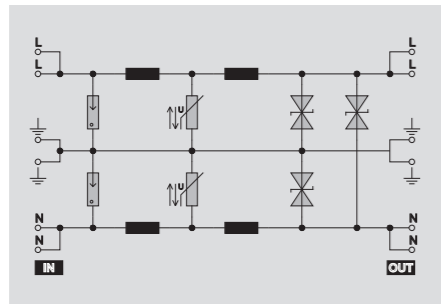

**Technical data**

<b>Technical data</b>	
Rated voltage (AC)	24 V
Rated voltage (DC)	24 V
max. continuous voltage, U <sub>c</sub> (AC)	27 V
Operating current, I <sub>max</sub>	10 A
Volume resistivity	0.04 Ω
Gas discharge tube	yes
Varistor	yes
Suppression diodes	yes
Cut-off frequency (-3 dB) at load impedance	8.0 kHz 4 Ω
Discharge current, max. (8/20 μs)	24 kA
Protection level on output side sym., input 1 kV/μs, typ.	40 V
Protection level on output side sym., input 8/20 μs, typ.	45 V
Protection level on output side unsym., input 1kV/μs, typ.	40 V
Protection level on output side unsym., input 8/20 μs, typ.	45 V
Design	RS section
Type of connection	Screw connection
Ambient temperature (operational)	-25 ... 40°C
Storage temperature	-25 ... 85°C

Rated voltage (AC)	24 V
Rated voltage (DC)	24 V
max. continuous voltage, U <sub>c</sub> (AC)	27 V
Operating current, I <sub>max</sub>	10 A
Volume resistivity	0.04 Ω
Gas discharge tube	yes
Varistor	yes
Suppression diodes	yes
Cut-off frequency (-3 dB) at load impedance	8.0 kHz 4 Ω
Discharge current, max. (8/20 μs)	24 kA
Protection level on output side sym., input 1 kV/μs, typ.	40 V
Protection level on output side sym., input 8/20 μs, typ.	45 V
Protection level on output side unsym., input 1kV/μs, typ.	40 V
Protection level on output side unsym., input 8/20 μs, typ.	45 V
Design	RS section
Type of connection	Screw connection
Ambient temperature (operational)	-25 ... 40°C
Storage temperature	-25 ... 85°C

Rated voltage (AC)	115 V
Rated voltage (DC)	115 V
max. continuous voltage, U <sub>c</sub> (AC)	130 V
Operating current, I <sub>max</sub>	10 A
Volume resistivity	0.04 Ω
Gas discharge tube	yes
Varistor	yes
Suppression diodes	yes
Cut-off frequency (-3 dB) at load impedance	30.0 kHz 20 Ω
Discharge current, max. (8/20 μs)	24 kA
Protection level on output side sym., input 1 kV/μs, typ.	200 V
Protection level on output side sym., input 8/20 μs, typ.	250 V
Protection level on output side unsym., input 1kV/μs, typ.	200 V
Protection level on output side unsym., input 8/20 μs, typ.	250 V
Design	RS section
Type of connection	Screw connection
Ambient temperature (operational)	-25 ... 40°C
Storage temperature	-25 ... 70°C

<b>Type of connection</b>	
Clamping range (rating- / min. / max.)	mm <sup>2</sup> 2.5 / 0.5 / 4
Length x width x height	mm 105 x 105 x 89

Clamping range (rating- / min. / max.)	mm <sup>2</sup> 2.5 / 0.5 / 4
Length x width x height	mm 105 x 105 x 89

Clamping range (rating- / min. / max.)	mm <sup>2</sup> 2.5 / 0.5 / 4
Length x width x height	mm 105 x 105 x 89

**Ordering data**

Type	Qty.	Order No.
RSU 24VUC 10A	1	8104201001

Type	Qty.	Order No.
RSU 24VUC 10A	1	8104201001

Type	Qty.	Order No.
RSU 115VUC 10A	1	8104221001

Note

Note

Note

**Accessories**

Note

Note

Note

**3-stage protection with screw connection**

- Surge protection RSU for power supplies
- with current-compensated inductor
- low residual voltage thanks to suppression diodes

**RSU 230 V UC 10 A**

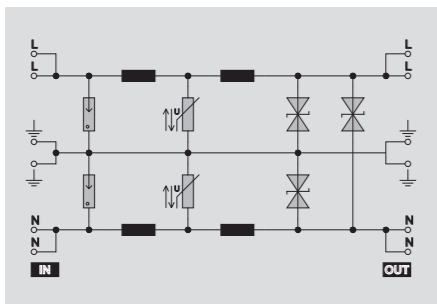

**Technical data**

Technical data	
Rated voltage (AC)	230 V
Rated voltage (DC)	230 V
max. continuous voltage, U <sub>c</sub> (AC)	250 V
Operating current, I <sub>max</sub>	10 A
Volume resistivity	0.04 Ω
Gas discharge tube	yes
Varistor	yes
Suppression diodes	yes
Cut-off frequency (-3 dB) at load impedance	90.0 kHz 40 kΩ
Discharge current, max. (8/20 μs)	24 kA
Protection level on output side sym., input 1 kV/μs, typ.	400 V
Protection level on output side sym., input 8/20 μs, typ.	420 V
Protection level on output side unsym., input 1kV/μs, typ.	400 V
Protection level on output side unsym., input 8/20 μs, typ.	420 V
Design	RS section
Type of connection	Screw connection
Ambient temperature (operational)	-25 ... 40°C
Storage temperature	-25 ... 70°C

Type of connection	
Clamping range (rating- / min. / max.)	mm <sup>2</sup> 2.5 / 0.5 / 4
Length x width x height	mm 105 x 105 x 89

Note

**Ordering data**

Type	Qty.	Order No.
RSU 230VUC 10A LP	1	8093281001

Note

**Accessories**

Note



## 3-stage protection with screw connection

### Plug-in surge protection

The Weidmüller LPU series consists of a PCB and the build-in SEG-U housing (to be ordered separately). These tried-and-tested protective components can be used in automated process, industrial and building services systems. Their great advantage is that the SEG-U housing can be connected in a number of different ways. The screw connection is standard, but screw/plug, Termipoint, wire-wrap and spade connections are also possible.

The plug-in PCB provides test options; a visual check as well as electrical tests on the individual components are possible. The three-stage LPU boards operate with gas discharge tubes, varistors, suppression diodes (TAZ) and decoupling inductances. The LPU boards are characterised by a high level of protection for currents up to 1.5 A. They are available in rated voltages of 24, 48, 115 and 230 V.

#### Note:

**The SEG-U housing for the LPU plug-in protection board must be ordered separately.**

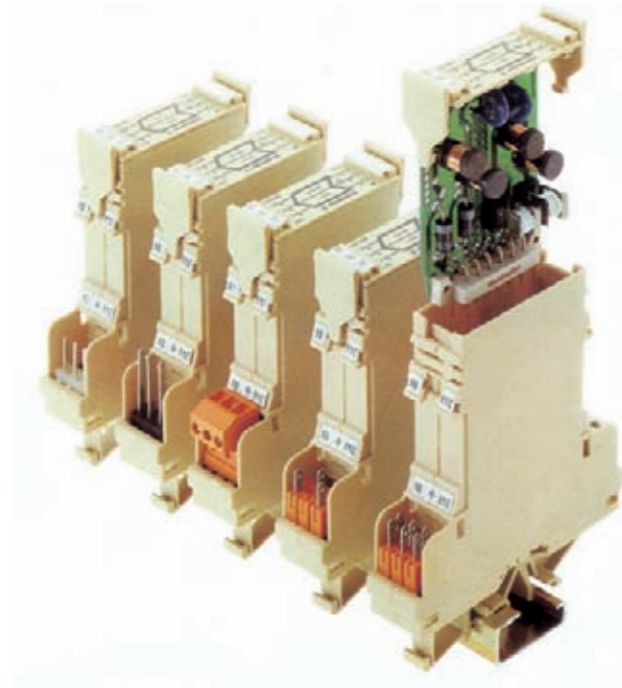

Three different LPU boards are available:

- Two signal lines protected against earth (suitable for binary signals).
- Analogue signals are protected against each other and against earth (e.g. 0 ... 20 mA circuits).
- Isolated signals are given high-resistance protection against earth and against each other (suitable for thermal signals).

A testing unit fitted in a case is available for the electrical tests. The protective elements, e.g. gas discharge tubes, varistors, suppression diodes, integrated on the LPU board are tested to check their rated data and permissible tolerances. The integral inductances are also checked for continuity.

The results of the tests are recorded either by way of red/green LEDs or the integral printer. A self-test is performed after switching on the testing unit. The electrical tests on the LPU board are carried out automatically after plugging in the LPU surge protection.

#### Dimensions SEG-U

- Width 20 mm
- Screw connection
- flexible 0.5 ... 2.5 mm<sup>2</sup>
- stranded 0.5 ... 4 mm<sup>2</sup>

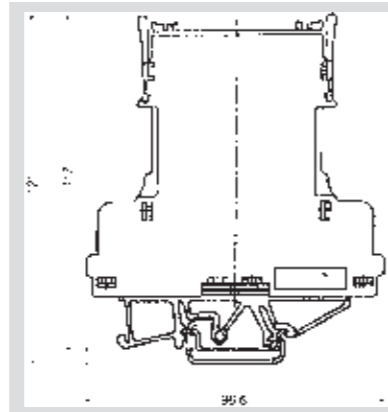



LPU series (plug-in)

3-stage protection on circuit card

Plug-in surge protection LPU

- Please note: the housing for the LPU protection card must be ordered separately

LPU 24 V DC 100 mA

Protection for current loops

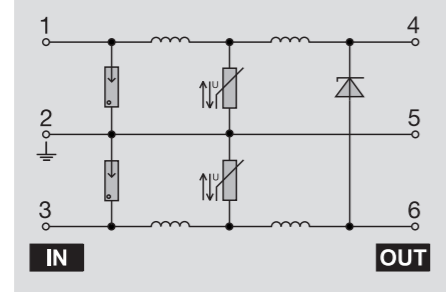

LPU 48 V UC 100 mA

Protection for current loops

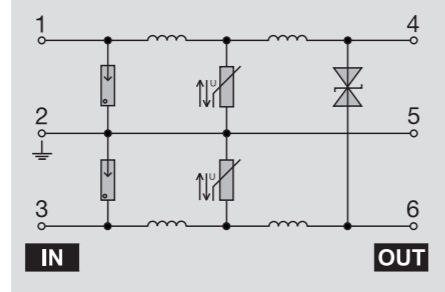

D



Surge protection for instrumentation and control equipment

Technical data

Technical data	LPU 24 V DC 100 mA	LPU 48 V UC 100 mA
Rated voltage (AC)	24 V	48 V
Rated voltage (DC)	29 V	48 V
max. continuous voltage, U <sub>c</sub> (AC)	29 V	53 V
Operating current, I <sub>max</sub>	0.1 A	0.1 A
Volume resistivity	12.50 Ω	12.50 Ω
Gas discharge tube	yes	yes
Varistor	yes	yes
Suppression diodes	yes	yes
Cut-off frequency (-3 dB) at load impedance	7.5 kHz / 240 Ω	9.0 kHz / 480 Ω
Discharge current, max. (8/20 μs)	6 kA	6 kA
Protection level on output side sym., input 1 kV/μs, typ.	34 V	82 V
Protection level on output side sym., input 8/20 μs, typ.	45 V	130 V
Protection level on output side unsym., input 1 kV/μs, typ.	34 V	82 V
Protection level on output side unsym., input 8/20 μs, typ.	45 V	130 V
Design	Plug-in card	Plug-in card
Type of connection	Plug-in connection	Plug-in connection
Ambient temperature (operational)	-25 ... 50°C	-25 ... 50°C
Storage temperature	-25 ... 85°C	-25 ... 85°C

Type of connection

Clamping range (rating- / min. / max.)	mm <sup>2</sup>	
Length x width x height	mm	96.6 x 20 x 117
Note		Height including enclosure SEG-U

Ordering data

Type	Qty.	Order No.
LPU 24VDC 100MA	1	on request
LPU 48VUC 100MA	1	8008330000

Note	Can be tested with test case
------	------------------------------

Accessories

Note	Housing SEG-U 8007871001
------	--------------------------



## LPU series (plug-in)

### 3-stage protection on circuit card

Plug-in surge protection LPU

- Please note: the housing for the LPU protection card must be ordered separately

### LPU 115 V UC 100 mA

Protection for current loops

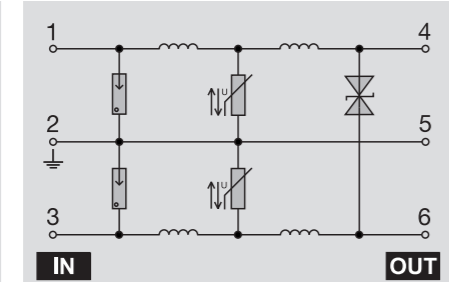

### LPU 24 V DC 100 mA SL

Protection for 2 binary signals

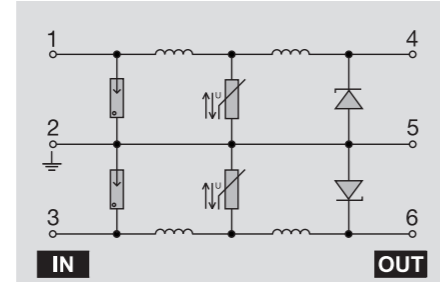

### Technical data

Technical data	LPU 115 V UC 100 mA	LPU 24 V DC 100 mA SL
Rated voltage (AC)	115 V	24 V
Rated voltage (DC)	115 V	29 V
max. continuous voltage, U <sub>c</sub> (AC)	130 V	0.1 A
Operating current, I <sub>max</sub>	0.1 A	12,50 Ω
Volume resistivity	12,50 Ω	yes
Gas discharge tube	yes	yes
Varistor	yes	yes
Suppression diodes	yes	yes
Cut-off frequency (-3 dB) at load impedance	9.0 kHz / 1100 Ω	7.5 kHz 240 Ω
Discharge current, max. (8/20 μs)	6 kA	6 kA
Protection level on output side sym., input 1 kV/μs, typ.	200 V	34 V
Protection level on output side sym., input 8/20 μs, typ.	250 V	45 V
Protection level on output side unsym., input 1 kV/μs, typ.	200 V	60 V
Protection level on output side unsym., input 8/20 μs, typ.	250 V	90 V
Design	Plug-in card	Plug-in card
Type of connection	Plug-in connection	Plug-in connection
Ambient temperature (operational)	-25 ... 50°C	-25 ... 60°C
Storage temperature	-25 ... 85°C	-25 ... 85°C

### Type of connection

Clamping range (rating- / min. / max.)	mm <sup>2</sup>	
Length x width x height	mm	96.6 x 20 x 117
<b>Note</b>		Height including enclosure SEG-U

### Ordering data

Type	Qty.	Order No.	Type	Qty.	Order No.
LPU 115VUC 100MA	1	8008350000	LPU 24VDC 100MA	1	8008230000
<b>Note</b>		Can be tested with test case	<b>Note</b>		Can be tested with test case

### Accessories

<b>Note</b>	Housing SEG-U 8007871001	Housing SEG-U 8007871001
-------------	--------------------------	--------------------------

**3-stage protection on circuit card**

Plug-in surge protection LPU

- Please note: the housing for the LPU protection card must be ordered separately

**LPU 48 V UC 100 mA SL**

Protection for 2 binary signals

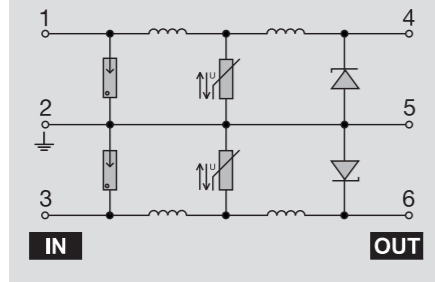

**LPU 115 V UC 100 mA SL**

Protection for 2 binary signals

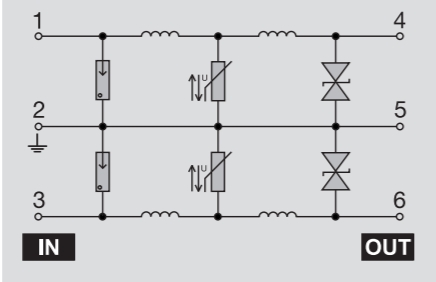

**Technical data**

<b>Technical data</b>	
Rated voltage (AC)	48 V
Rated voltage (DC)	48 V
max. continuous voltage, U <sub>c</sub> (AC)	53 V
Operating current, I <sub>max</sub>	0.1 A
Volume resistivity	12.50 Ω
Gas discharge tube	yes
Varistor	yes
Suppression diodes	yes
Cut-off frequency (-3 dB) at load impedance	17.0 kHz 480 Ω
Discharge current, max. (8/20 μs)	6 kA
Protection level on output side sym., input 1 kV/μs, typ.	82 V
Protection level on output side sym., input 8/20 μs, typ.	130 V
Protection level on output side unsym., input 1 kV/μs, typ.	160 V
Protection level on output side unsym., input 8/20 μs, typ.	260 V
Design	Plug-in card
Type of connection	Plug-in connection
Ambient temperature (operational)	-25 ... 60°C
Storage temperature	-25 ... 85°C

<b>Technical data</b>	
Rated voltage (AC)	48 V
Rated voltage (DC)	48 V
max. continuous voltage, U <sub>c</sub> (AC)	53 V
Operating current, I <sub>max</sub>	0.1 A
Volume resistivity	12.50 Ω
Gas discharge tube	yes
Varistor	yes
Suppression diodes	yes
Cut-off frequency (-3 dB) at load impedance	17.0 kHz 480 Ω
Discharge current, max. (8/20 μs)	6 kA
Protection level on output side sym., input 1 kV/μs, typ.	82 V
Protection level on output side sym., input 8/20 μs, typ.	130 V
Protection level on output side unsym., input 1 kV/μs, typ.	160 V
Protection level on output side unsym., input 8/20 μs, typ.	260 V
Design	Plug-in card
Type of connection	Plug-in connection
Ambient temperature (operational)	-25 ... 60°C
Storage temperature	-25 ... 85°C

<b>Technical data</b>	
Rated voltage (AC)	115 V
Rated voltage (DC)	115 V
max. continuous voltage, U <sub>c</sub> (AC)	130 V
Operating current, I <sub>max</sub>	0.1 A
Volume resistivity	12.50 Ω
Gas discharge tube	yes
Varistor	yes
Suppression diodes	yes
Cut-off frequency (-3 dB) at load impedance	40.0 kHz 1100 Ω
Discharge current, max. (8/20 μs)	6 kA
Protection level on output side sym., input 1 kV/μs, typ.	200 V
Protection level on output side sym., input 8/20 μs, typ.	250 V
Protection level on output side unsym., input 1 kV/μs, typ.	400 V
Protection level on output side unsym., input 8/20 μs, typ.	500 V
Design	Plug-in card
Type of connection	Plug-in connection
Ambient temperature (operational)	-25 ... 60°C
Storage temperature	-25 ... 85°C

**Type of connection**

Clamping range (rating- / min. / max.)	mm <sup>2</sup>
Length x width x height	mm

Clamping range (rating- / min. / max.)	mm <sup>2</sup>
Length x width x height	mm

Clamping range (rating- / min. / max.)	mm <sup>2</sup>
Length x width x height	mm

**Note**

Height including enclosure SEG-U

Height including enclosure SEG-U

**Ordering data**

Type	Qty.	Order No.
LPU 48VUC 100MA	1	8008250000

Type	Qty.	Order No.
LPU 48VUC 100MA	1	8008250000

Type	Qty.	Order No.
LPU 115VUC 100MA	1	8008260000

**Note**

Can be tested with test case

Can be tested with test case

**Accessories**

**Note**

Housing SEG-U 8007871001

Housing SEG-U 8007871001





## LPU series (plug-in)

### 3-stage protection on circuit card

Plug-in surge protection LPU

- Please note: the housing for the LPU protection card must be ordered separately

### LPU 24 V UC 1.5 A

Protection for current loops



### LPU 48 V UC 1.5 A

Protection for current loops

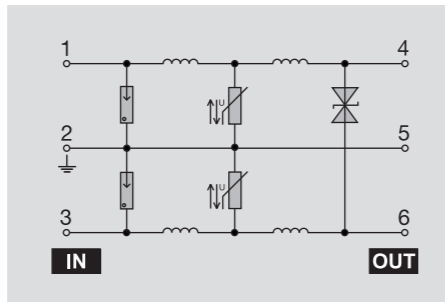
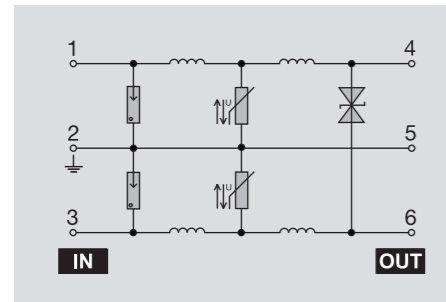

### Technical data

Technical data	LPU 24 V UC 1.5 A	LPU 48 V UC 1.5 A
Rated voltage (AC)	24 V	48 V
Rated voltage (DC)	24 V	48 V
max. continuous voltage, U <sub>c</sub> (AC)	27 V	53 V
Operating current, I <sub>max</sub>	1.5 A	1.5 A
Volume resistivity	0.20 Ω	0.20 Ω
Gas discharge tube	yes	yes
Varistor	yes	yes
Suppression diodes	yes	yes
Cut-off frequency (-3 dB) at load impedance	150.0 kHz 16 Ω	300.0 kHz 32 Ω
Discharge current, max. (8/20 μs)	6 kA	6 kA
Protection level on output side sym., input 1 kV/μs, typ.	34 V	82 V
Protection level on output side sym., input 8/20 μs, typ.	45 V	130 V
Protection level on output side unsym., input 1 kV/μs, typ.	34 V	82 V
Protection level on output side unsym., input 8/20 μs, typ.	45 V	130 V
Design	Plug-in card	Plug-in card
Type of connection	Plug-in connection	Plug-in connection
Ambient temperature (operational)	-25 ... 50°C	-25 ... 50°C
Storage temperature	-25 ... 85°C	-25 ... 85°C

### Type of connection

Clamping range (rating- / min. / max.)	mm <sup>2</sup>	
Length x width x height	mm	96.6 x 20 x 117
<b>Note</b>		Height including enclosure SEG-U

### Ordering data

Type	Qty.	Order No.	Type	Qty.	Order No.
LPU 24VUC/ 1.5A	1	8237700000	LPU 48VUC 1.5A	1	8008440000
<b>Note</b>	Can be tested with test case		Can be tested with test case		

### Accessories

<b>Note</b>	Housing SEG-U 8007871001	Housing SEG-U 8007871001
-------------	--------------------------	--------------------------

LPU series (plug-in)

Surge protection for instrumentation and control equipment

3-stage protection on circuit card

Plug-in surge protection LPU

- Please note: the housing for the LPU protection card must be ordered separately

LPU 115 V UC 1.5 A

Protection for current loops

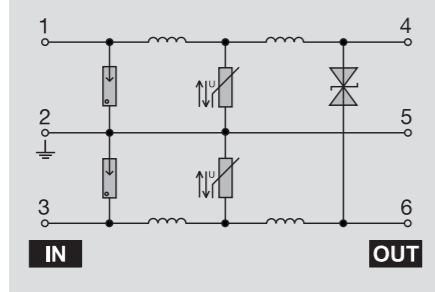

LPU 230 V UC 1.5 A

Protection for current loops

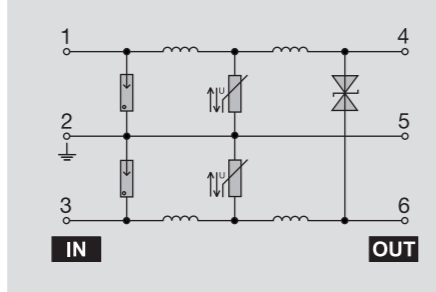

Technical data

Technical data	LPU 115 V UC 1.5 A	LPU 230 V UC 1.5 A
Rated voltage (AC)	115 V	230 V
Rated voltage (DC)	115 V	230 V
max. continuous voltage, U <sub>c</sub> (AC)	130 V	250 V
Operating current, I <sub>max</sub>	1.5 A	1.5 A
Volume resistivity	0.20 Ω	0.20 Ω
Gas discharge tube	yes	yes
Varistor	yes	yes
Suppression diodes	yes	yes
Cut-off frequency (-3 dB) at load impedance	600.0 kHz 70 kΩ	1.0 MHz 150 kΩ
Discharge current, max. (8/20 μs)	6 kA	6 kA
Protection level on output side sym., input 1 kV/μs, typ.	200 V	400 V
Protection level on output side sym., input 8/20 μs, typ.	250 V	420 V
Protection level on output side unsym., input 1 kV/μs, typ.	200 V	400 V
Protection level on output side unsym., input 8/20 μs, typ.	250 V	420 V
Design	Plug-in card	Plug-in card
Type of connection	Plug-in connection	Plug-in connection
Ambient temperature (operational)	-25 ... 50°C	-25 ... 50°C
Storage temperature	-25 ... 85°C	-25 ... 85°C

Type of connection

Clamping range (rating- / min. / max.)	mm <sup>2</sup>	
Length x width x height	mm	96.6 x 20 x 117
Note		Height including enclosure SEG-U

Ordering data

Type	Qty.	Order No.	Type	Qty.	Order No.
LPU 115VUC 1,5A	1	8008450000	LPU 230VUC 1,5A	1	8008460000

Note	Can be tested with test case	Can be tested with test case
------	------------------------------	------------------------------

Accessories

Note	Housing SEG-U 8007871001	Housing SEG-U 8007871001
------	--------------------------	--------------------------



**LPU series (plug-in)**

**3-stage protection on circuit card**

Plug-in surge protection LPU

- Please note: the housing for the LPU protection card must be ordered separately

**LPU 24 V DC 100 mA**

Protection for current loops



**LPU 48 V UC 100 mA**

Protection for current loops

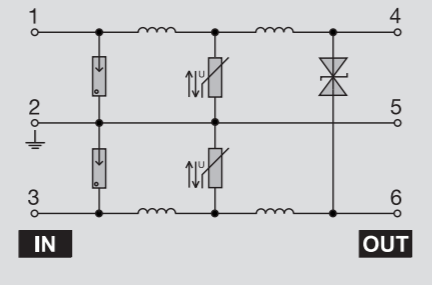
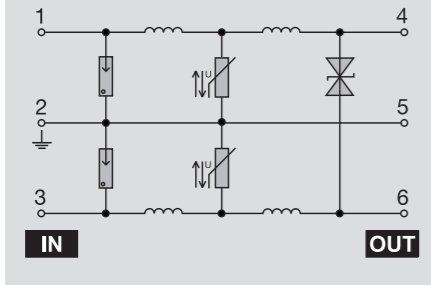

**Technical data**

<b>Technical data</b>	
Rated voltage (AC)	
Rated voltage (DC)	24 V
max. continuous voltage, U <sub>c</sub> (AC)	29 V
Operating current, I <sub>max</sub>	0.1 A
Volume resistivity	12.50 Ω
Gas discharge tube	yes
Varistor	yes
Suppression diodes	yes
Cut-off frequency (-3 dB) at load impedance	7.5 kHz 240 Ω
Discharge current, max. (8/20 μs)	6 kA
Protection level on output side sym., input 1 kV/μs, typ.	34 V
Protection level on output side sym., input 8/20 μs, typ.	45 V
Protection level on output side unsym., input 1kV/μs, typ.	600 V
Protection level on output side unsym., input 8/20 μs, typ.	700 V
Design	Plug-in card
Type of connection	Plug-in connection
Ambient temperature (operational)	-25 ... 60°C
Storage temperature	-25 ... 85°C

<b>Technical data</b>	
Rated voltage (AC)	
Rated voltage (DC)	24 V
max. continuous voltage, U <sub>c</sub> (AC)	29 V
Operating current, I <sub>max</sub>	0.1 A
Volume resistivity	12.50 Ω
Gas discharge tube	yes
Varistor	yes
Suppression diodes	yes
Cut-off frequency (-3 dB) at load impedance	7.5 kHz 240 Ω
Discharge current, max. (8/20 μs)	6 kA
Protection level on output side sym., input 1 kV/μs, typ.	34 V
Protection level on output side sym., input 8/20 μs, typ.	45 V
Protection level on output side unsym., input 1kV/μs, typ.	600 V
Protection level on output side unsym., input 8/20 μs, typ.	700 V
Design	Plug-in card
Type of connection	Plug-in connection
Ambient temperature (operational)	-25 ... 60°C
Storage temperature	-25 ... 85°C

<b>Technical data</b>	
Rated voltage (AC)	48 V
Rated voltage (DC)	48 V
max. continuous voltage, U <sub>c</sub> (AC)	53 V
Operating current, I <sub>max</sub>	0.1 A
Volume resistivity	12.50 Ω
Gas discharge tube	yes
Varistor	yes
Suppression diodes	yes
Cut-off frequency (-3 dB) at load impedance	17.0 kHz 480 Ω
Discharge current, max. (8/20 μs)	6 kA
Protection level on output side sym., input 1 kV/μs, typ.	82 V
Protection level on output side sym., input 8/20 μs, typ.	130 V
Protection level on output side unsym., input 1kV/μs, typ.	600 V
Protection level on output side unsym., input 8/20 μs, typ.	700 V
Design	Plug-in card
Type of connection	Plug-in connection
Ambient temperature (operational)	-25 ... 60°C
Storage temperature	-25 ... 85°C

**Type of connection**

Clamping range (rating- / min. / max.)	mm <sup>2</sup>
Length x width x height	mm

Clamping range (rating- / min. / max.)	mm <sup>2</sup>
Length x width x height	96.6 x 20 x 117

Clamping range (rating- / min. / max.)	mm <sup>2</sup>
Length x width x height	96.6 x 20 x 117

Note: Height including enclosure SEG-U

Note: Height including enclosure SEG-U

Note: Height including enclosure SEG-U

**Ordering data**

Type	Qty.	Order No.
LPU 24VDC 100MA	1	8008390000

Type	Qty.	Order No.
LPU 24VDC 100MA	1	8008390000

Type	Qty.	Order No.
LPU 48VUC 100MA	1	on request

Note: Can be tested with test case

Note: Can be tested with test case

Note: Can be tested with test case

**Accessories**

Note: Housing SEG-U 8007871001

Note: Housing SEG-U 8007871001

Note: Housing SEG-U 8007871001

**3-stage protection on circuit card**

Plug-in surge protection LPU

- Please note: the housing for the LPU protection card must be ordered separately

**LPU 115 V UC 100 mA**

Floating earth

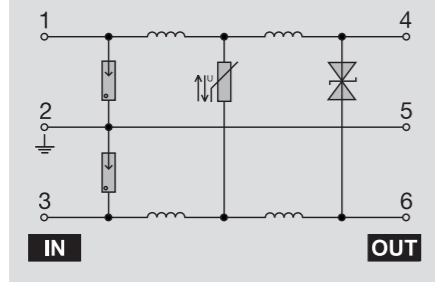

**LPU 230 V UC 100 mA**

Floating earth

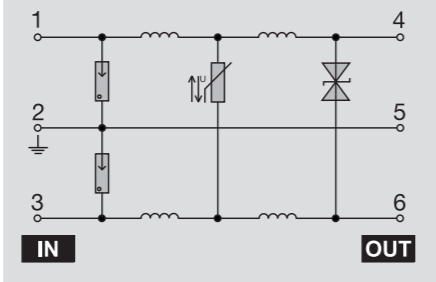

Surge protection for instrumentation and control equipment

**Technical data**

<b>Technical data</b>	
Rated voltage (AC)	115 V
Rated voltage (DC)	115 V
max. continuous voltage, U <sub>c</sub> (AC)	130 V
Operating current, I <sub>max</sub>	0.1 A
Volume resistivity	12.50 Ω
Gas discharge tube	yes
Varistor	yes
Suppression diodes	yes
Cut-off frequency (-3 dB) at load impedance	40.0 kHz 1100 Ω
Discharge current, max. (8/20 μs)	6 kA
Protection level on output side sym., input 1 kV/μs, typ.	200 V
Protection level on output side sym., input 8/20 μs, typ.	220 V
Protection level on output side unsym., input 1kV/μs, typ.	600 V
Protection level on output side unsym., input 8/20 μs, typ.	700 V
Design	Plug-in card
Type of connection	Plug-in connection
Ambient temperature (operational)	-25 ... 60°C
Storage temperature	-25 ... 85°C

<b>Technical data</b>	
Rated voltage (AC)	230 V
Rated voltage (DC)	230 V
max. continuous voltage, U <sub>c</sub> (AC)	250 V
Operating current, I <sub>max</sub>	0.1 A
Volume resistivity	12.50 Ω
Gas discharge tube	yes
Varistor	yes
Suppression diodes	yes
Cut-off frequency (-3 dB) at load impedance	80.0 kHz 2200 Ω
Discharge current, max. (8/20 μs)	6 kA
Protection level on output side sym., input 1 kV/μs, typ.	400 V
Protection level on output side sym., input 8/20 μs, typ.	420 V
Protection level on output side unsym., input 1kV/μs, typ.	600 V
Protection level on output side unsym., input 8/20 μs, typ.	700 V
Design	Plug-in card
Type of connection	Plug-in connection
Ambient temperature (operational)	-25 ... 60°C
Storage temperature	-25 ... 85°C

<b>Technical data</b>	
Rated voltage (AC)	230 V
Rated voltage (DC)	230 V
max. continuous voltage, U <sub>c</sub> (AC)	250 V
Operating current, I <sub>max</sub>	0.1 A
Volume resistivity	12.50 Ω
Gas discharge tube	yes
Varistor	yes
Suppression diodes	yes
Cut-off frequency (-3 dB) at load impedance	80.0 kHz 2200 Ω
Discharge current, max. (8/20 μs)	6 kA
Protection level on output side sym., input 1 kV/μs, typ.	400 V
Protection level on output side sym., input 8/20 μs, typ.	420 V
Protection level on output side unsym., input 1kV/μs, typ.	600 V
Protection level on output side unsym., input 8/20 μs, typ.	700 V
Design	Plug-in card
Type of connection	Plug-in connection
Ambient temperature (operational)	-25 ... 60°C
Storage temperature	-25 ... 85°C

<b>Type of connection</b>	
Clamping range (rating- / min. / max.)	mm <sup>2</sup>
Length x width x height	mm
<b>Note</b>	

<b>Type of connection</b>	
Clamping range (rating- / min. / max.)	mm <sup>2</sup>
Length x width x height	mm
<b>Note</b>	

<b>Type of connection</b>	
Clamping range (rating- / min. / max.)	mm <sup>2</sup>
Length x width x height	mm
<b>Note</b>	

**Ordering data**

<b>Ordering data</b>		
<b>Type</b>	<b>Qty.</b>	<b>Order No.</b>
LPU 115VUC 100MA	1	on request
<b>Note</b>	Can be tested with test case	

<b>Ordering data</b>		
<b>Type</b>	<b>Qty.</b>	<b>Order No.</b>
LPU 115VUC 100MA	1	on request
<b>Note</b>	Can be tested with test case	

<b>Ordering data</b>		
<b>Type</b>	<b>Qty.</b>	<b>Order No.</b>
LPU 230VUC 100MA	1	on request
<b>Note</b>	Can be tested with test case	

**Accessories**

<b>Note</b>	Housing SEG-U 8007871001
-------------	--------------------------

<b>Note</b>	Housing SEG-U 8007871001
-------------	--------------------------

<b>Note</b>	Housing SEG-U 8007871001
-------------	--------------------------



## Extract from the TRbF – Technical Rules for Combustible Fluids

### Requirements:

- Indoor plants that require licences and are situated above ground for the storage, filling or conveying of combustible fluids, or outdoor tanks above ground and underground tanks not surrounded on all sides by earth, masonry or concrete or several of these materials must be protected against ignition hazards and lightning strikes by suitable means.
- Paragraph 1 also applies to outdoor tanks above ground that are used for the storage of combustible fluids of hazard class A III if certain fluids of this hazard class are stored together with those of hazard classes A I, A II or B within one tank bund.
- Irrespective of paragraphs 1 and 2 and furthermore, intrinsically safe circuits whose lines enter the tank for the purpose of, for example, instrumentation and control, ...

### ... must satisfy the following requirements:

- Surge protection in a metal enclosures (e.g. terminal box) must be incorporated before the line enters the tank. The steel enclosure containing the surge protection is to have a direct and dependable electrically conductive connection with the tank wall or the shielding that guarantees a safe and secure equipotential bonding.
- A suitable cable/line complying with CENELEC harmonisation documents 21 and 22 is required from the control room to the steel enclosure containing the surge protection and the cable/line from the surge protection installation to the storage tank should be provided in a protective metal conduit. The metal sheathing, shielding or the protective metal conduit must be earthed. The test voltage  $U_{eff}$  between the wires and the metal sheathing, shielding or protective metal conduit for the cable/line from the metal housing containing the surge protection to the storage tank must be at least 1500 V.
- The cable/line between the steel enclosure containing the surge protection and the entry into the tank should be routed in such a way that lightning is unlikely to affect this line.

### Solutions:

#### Surge protection installation at the actuator (control room):

This is where the surge protection is earthed. Types LPU 800433 or LPU 800844 are used. The plug-in LPU surge protection is plugged into the SEG-U housing (available as an accessory). But the surge protection system can be used in the form of a terminal:

- for current loops – DKU 843777
- for binary signals
  - 24 V – DKU 801580 or 802581
  - 60 V – DKU 801928 or 801929

#### Surge protection installation at the sensor

This is where the surge protection installation has a floating earth connection via a gas discharge tube. The earth is achieved via a gas discharge tube for 470 V from the line to earth (DK4U 940044 / DK4U 940045). Surge protection may be incorporated between the lines, e.g. LPU 822524 / LPU 822525 or DK4U 940040, DK4U 940050. The surge protection installation upstream of the sensor must be incorporated in an enclosure complying with the TRbF regulations before the line enters the tank. Weidmüller housings, which carry the appropriate approval, can be used for this. The enclosure must have a conductive connection to the tank.

#### Installation of surge protection

The surge protection developed by Weidmüller comprises “passive components” which can be used taking into account the internal inductance and capacitance in the instrumentation and control circuits. To simplify the installation, some other products from the standard surge protection range have been approved to ATEX requirements (complying with EN 50014, EN 50020 and EN 50281).

These products can be employed in both intrinsically safe and non-intrinsically safe circuits. The difference lies in the maximum permissible rated data of these products. When planning your instrumentation and control circuits, please refer to the technical data on the following pages.

Surge protection for instrumentation and control equipment with ATEX approval

DKU

Slimline surge protection terminals with ATEX approval

DKU 24 V

for TS 32 / TS 35



DKU 48 V

for TS 32 / TS 35



Surge protection for instrumentation and control equipment

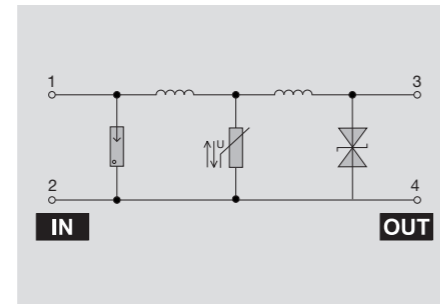
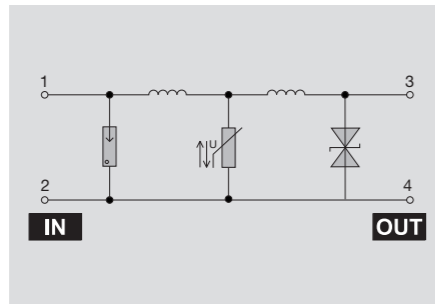

Technical data

**Technical data**  
 DC voltage  
 Volume resistance 1/3  
 Rated current per path  
 Inductance of 4-pole network L<sub>i</sub>  
 Capacitance of 4-pole network C<sub>i</sub>  
 Source impedance frequency response at 50 Ω/-3 dB  
 ⌀T<sub>u</sub> at 0.1 A and 60 °C ambient temperature, typical  
 Sparkover voltage of gas discharge tube at 1 kV/μs, typical  
 Interference voltage at output for 1 kV/μs at input, typical  
 Interference voltage at output for 8/20 μs and 2.5 kA at input, typical  
 max. leakage current to PE  
 Ingress protection class  
 Circuit earthed for safety  
 Operating temperature  
 Clamping point with self-locking screw  
 Approval  
 Registered design No.

DC voltage	28 V
Volume resistance 1/3	3.5 Ω
Rated current per path	0.22 A
Inductance of 4-pole network L <sub>i</sub>	0.2 mH
Capacitance of 4-pole network C <sub>i</sub>	2.5 nF
Source impedance frequency response at 50 Ω/-3 dB	500 kHz at R <sub>i</sub> = 240 Ω
⌀T <sub>u</sub> at 0.1 A and 60 °C ambient temperature, typical	18 K
Sparkover voltage of gas discharge tube at 1 kV/μs, typical	700 V
Interference voltage at output for 1 kV/μs at input, typical	33 V
Interference voltage at output for 8/20 μs and 2.5 kA at input, typical	38 V
max. leakage current to PE	10 μA
Ingress protection class	IP20
Circuit earthed for safety	yes
Operating temperature	-25 °C ... +60 °C
Clamping point with self-locking screw	yes
Approval	II 2 G EEx ia IIC T6 or II 2 D T85 °C IP6X
Registered design No.	TÜV 04 ATEX 2551 X

DC voltage	60 V
Volume resistance 1/3	3.5 Ω
Rated current per path	0.22 A
Inductance of 4-pole network L <sub>i</sub>	0.2 mH
Capacitance of 4-pole network C <sub>i</sub>	1 nF
Source impedance frequency response at 50 Ω/-3 dB	1000 kHz at R <sub>i</sub> = 480 Ω
⌀T <sub>u</sub> at 0.1 A and 60 °C ambient temperature, typical	11 K
Sparkover voltage of gas discharge tube at 1 kV/μs, typical	700 V
Interference voltage at output for 1 kV/μs at input, typical	82 V
Interference voltage at output for 8/20 μs and 2.5 kA at input, typical	100 V
max. leakage current to PE	10 μA
Ingress protection class	IP20
Circuit earthed for safety	yes
Operating temperature	-25 °C ... +60 °C
Clamping point with self-locking screw	yes
Approval	II 2 G EEx ia IIC T6 or II 2 D T85 °C IP6X
Registered design No.	TÜV 04 ATEX 2551 X

Connect the earth terminal to the equipotential bonding.  
 When using the surge protection component in areas at risk of dust explosion, provide a housing that complies with class of protection IP 6X at least (to EN 60529) and also satisfies the conditions of EN 50291-1-1 points 4, 8 and 9.

Connect the earth terminal to the equipotential bonding.  
 When using the surge protection component in areas at risk of dust explosion, provide a housing that complies with class of protection IP 6X at least (to EN 60529) and also satisfies the conditions of EN 50291-1-1 points 4, 8 and 9.

Note

Ordering data

Version	Type	Qty.	Order No.
TS 32	DKU 32 24 VDC 0,22 A		801580000
TS 35	DKU 35 24 VDC 0,22 A		801581000

Version	Type	Qty.	Order No.
TS 32	DKU 32 48 VUC 0,22 A		801928000
TS 35	DKU 35 48 VUC 0,22 A		801929000

Note

Accessories

Accessories	Qty.	Order No.
Abschlussplatte AP DKT 4 PA		068756000

Accessories	Qty.	Order No.
Abschlussplatte AP DKT 4 PA		068756000

Note

Surge protection for instrumentation and control equipment with ATEX approval

**LPU pluggable surge protection**

with ATEX approval

**LPU 24 V 0.5 A**

**LPU 29 V 0.062 A**

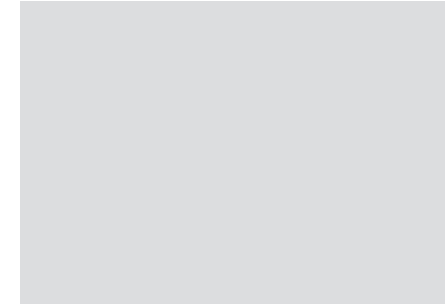
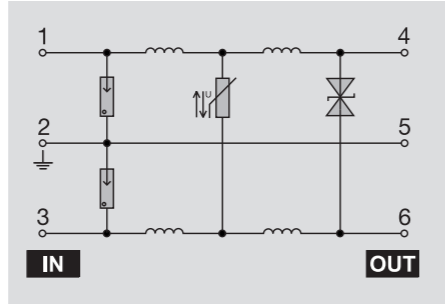
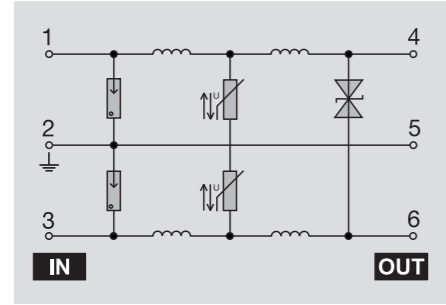

**Technical data**

**Technical data**  
 DC voltage  
 Volume resistance 1/3  
 Rated current per path  
 Inductance of 4-pole network L<sub>I</sub>  
 Capacitance of 4-pole network C<sub>I</sub>  
 Source impedance frequency response at 50 Ω/-3 dB  
 ∅ T<sub>u</sub> at 0.1 A and 60 °C ambient temperature, typical  
 Sparkover voltage of gas discharge tube at 1 kV/μs, typical  
 Interference voltage at output for 1 kV/μs at input, typical  
 Interference voltage at output for 8/20 μs and 2.5 kA at input, typical  
 max. leakage current to PE  
 Ingress protection class  
 Storage temperature  
 Operating temperature  
 Circuit earthed for safety  
 Clamping point with self-locking screw  
 Approval  
 Registered design No.

24 V
0.15 Ω
0.5 A
< 0.1 mH
7.5 nF
150 kHz at R <sub>i</sub> = 16 Ω
< 15 K
700 V
39 V
65 V
10 μA
IP20
-25 °C ... +85 °C
-25 °C ... +60 °C
yes
yes
II 2 G EEx ia IIC T6 or II 2 D T85 °C IP6X
TÜV 04 ATEX 2551 X

29 V
0.15 Ω
62 mA
9.5 mH
6 nF
4.5 kHz at R <sub>i</sub> = 240 Ω
< 15 K
800 V
33 V
38 V
10 μA
IP20
-25 °C ... +85 °C
-25 °C ... +60 °C
no
yes
II 2 G EEx ia IIC T6 or II 2 D T85 °C IP6X
TÜV 04 ATEX 2551 X

Connect the earth terminal to the equipotential bonding.  
 When using the surge protection component in areas at risk of dust explosion, provide a housing that complies with class of protection IP 6X at least (to EN 60529) and also satisfies the conditions of EN 50281-1-1 points 4, 8 and 9.

Connect the earth terminal to the equipotential bonding.  
 When using the surge protection component in areas at risk of dust explosion, provide a housing that complies with class of protection IP 6X at least (to EN 60529) and also satisfies the conditions of EN 50281-1-1 points 4, 8 and 9.

**Notes**

**Ordering data**

Version	Type	Qty	Order No
	LPU 24 VUC 0.5A		8008430000

Type	Qty	Order No
LPU 24 VUC 0.5A		8008430000

Version	Type	Qty	Order No
	LPU 24 V DC 62 mA		8225240000

**Notes**

**Accessories**

Version	Type	Qty	Order No
	Gehäuse SEG-U		8007871001

Type	Qty	Order No
Gehäuse SEG-U		8007871001

Version	Type	Qty	Order No
	Gehäuse SEG-U		8007871001

**Notes**

**LPU pluggable surge protection LPU**

**LPU 60 V 0.5 A**

with ATEX approval

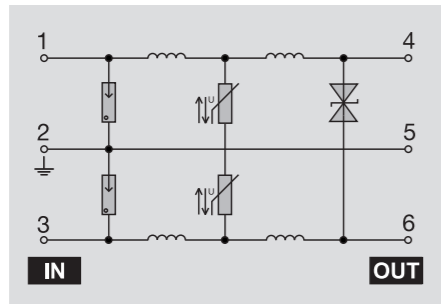

**Technical data**

Technical data	
DC voltage	60 V
Volume resistance 1/3	13 Ω
Rated current per path	0.5 A
Inductance of 4-pole network Li	< 0.1 mH
Capacitance of 4-pole network Ci	3.5 nF
Source impedance frequency response at 50 Ω/-3 dB	300 kHz at Ri = 32 Ω
∅ Tu at 0.1 A and 60 °C ambient temperature, typical	< 15 K
Sparkover voltage of gas discharge tube at 1 kV/μs, typical	700 V
Interference voltage at output for 1 kV/μs at input, typical	82 V
Interference voltage at output for 8/20 μs and 2.5 kA at input, typical	115 V
max. leakage current to PE	10 μA
Ingress protection class	IP20
Storage temperature	-25 °C ... +85 °C
Operating temperature	-25 °C ... +60 °C
Circuit earthed for safety	yes
Clamping point with self-locking screw	yes
Approval	II 2 G EEx ia IIC T6 to II 2 D T85 °C IP6X
Registered design No.	TÜV 04 ATEX 2551 X

Connect the earth terminal to the equipotential bonding.  
 When using the surge protection component in areas at risk of dust explosion, provide a housing that complies with class of protection IP 6X at least (to EN 60529) and also satisfies the conditions of EN 50281-1-1 points 4, 8 and 9.

**Notes**

**Ordering data**

Version	Type	Qty	Order No.
	LPU 60V 0,5A		8008440000

**Notes**

**Accessories**

Version	Type	Qty	Order No.
	Gehäuse SEG-U		8007871001

**Notes**

Surge protection for instrumentation and control equipment

**D**



**Surge protection for instrumentation and control equipment with ATEX approval**

**DKU slimline surge protection terminals**

with ATEX approval

**DKU 48 V**

**DKU 65 V**

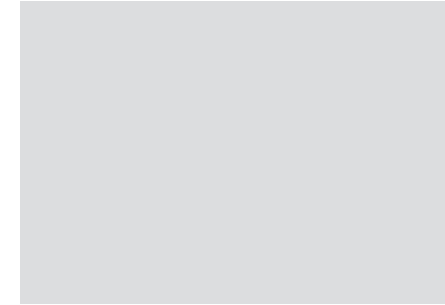
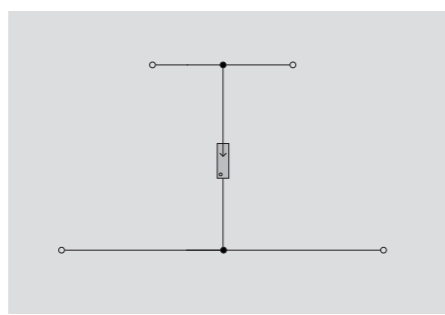
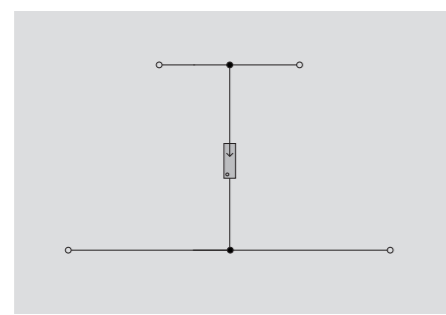

**Technical data**

**Technical data**  
 DC voltage  
 Volume resistance 1/3  
 Rated current per path  
 Inductance of 4-pole network L<sub>i</sub>  
 Capacitance of 4-pole network C<sub>i</sub>  
 Source impedance frequency response at 50 Ω/-3 dB  
 ∅ T<sub>u</sub> at 0.1 A and 60 °C ambient temperature, typical  
 Sparkover voltage of gas discharge tube at 1 kV/μs, typical  
 Interference voltage at output for 1 kV/μs at input, typical  
 Interference voltage at output for 8/20 μs and 2.5 kA at input, typical  
 max. leakage current to PE  
 Ingress protection class  
 Circuit earthed for safety  
 Operating temperature  
 Circuit safety grounded  
 Clamping point with self-locking screw  
 Approval  
 Registered design No.

48 V
-
0.5 A
-
-
-
< 15 K
700 V
700 V
800 V
1 μA
IP20
-25 °C ... +85 °C
-25 °C ... +60 °C
yes
yes
II 2 G EEx ia IIC T6 or II 2 D T85 °C IP6X
TÜV 04 ATEX 2551 X

65 V
-
0.5 A
-
-
-
< 15 K
1100 V
1100 V
1200 V
1 μA
IP20
-25 °C ... +85 °C
-25 °C ... +60 °C
no
yes
II 2 G EEx ia IIC T6 or II 2 D T85 °C IP6X
TÜV 04 ATEX 2551 X

Connect the earth terminal to the equipotential bonding.  
 When using the surge protection component in areas at risk of dust explosion, provide a housing that complies with class of protection IP 6X at least (to EN 60529) and also satisfies the conditions of EN 50281-1-1 points 4, 8 and 9.

Connect the earth terminal to the equipotential bonding.  
 When using the surge protection component in areas at risk of dust explosion, provide a housing that complies with class of protection IP 6X at least (to EN 60529) and also satisfies the conditions of EN 50281-1-1 points 4, 8 and 9.

**Notes**

**Ordering data**

Version	Type	Qty	Order No.
	DK 4/35 U 90 V 20 kA		9400500000
	DK 4/32 U 90 V 20 kA		9400400000

Type	Qty	Order No.
DK 4/35 U 90 V 20 kA		9400500000
DK 4/32 U 90 V 20 kA		9400400000

Type	Qty	Order No.
DK 4/35 U 470 V 20 kA		9400540000
DK 4/32 U 470 V 20 kA		on request

**Notes**

**Accessories**

Type	Qty	Order No.
AP DK4		0359260000

Type	Qty	Order No.
AP DK4		0359260000

Type	Qty	Order No.
AP DK4		0359260000

**Notes**

**DKU slimline surge protection**

with ATEX approval

**DKU DK 5 28 V**

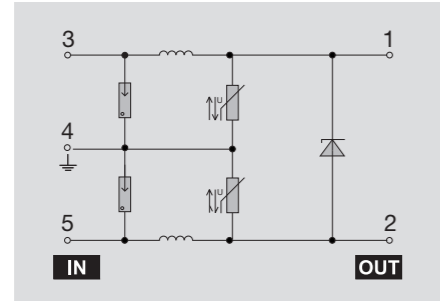

**Technical data**

Technical data	
DC voltage	28 V
Volume resistance 1/3	3.5 Ω
Rated current per path	0.3 A
Inductance of 4-pole network L <sub>i</sub>	0.2 mH
Capacitance of 4-pole network C <sub>i</sub>	1.3 nF
Source impedance frequency response at 50 Ω/-3 dB	500 kHz at R <sub>i</sub> = 240 Ω
∅ T <sub>u</sub> at 0.1 A and 60 °C ambient temperature, typical	< 15 K
Sparkover voltage of gas discharge tube at 1 kV/μs, typical	700 V
Interference voltage at output for 1 kV/μs at input, typical	33 V
Interference voltage at output for 8/20 μs and 2.5 kA at input, typical	38 V
max. leakage current to PE	10 μA
Ingress protection class	IP20
Storage temperature	-25 °C ... +85 °C
Operating temperature	-25 °C ... +60 °C
Circuit earthed for safety	yes
Clamping point with self-locking screw	yes
Approval	II 2 G EEx ia IIC T6 or II 2 D T85 °C IP6X
Registered design No.	TÜV 04 ATEX 2551 X

Connect the earth terminal to the equipotential bonding.  
When using the surge protection component in areas at risk of dust explosion, provide a housing that complies with class of protection IP 6X at least (to EN 60529) and also satisfies the conditions of EN 50281-1-1 points 4, 8 and 9.

**Notes**

**Ordering data**

Version	Type	Qty	Order No.
	DKU DK5 24 VDC 100 MA		8437770000

**Notes**

**Accessories**

	Type	Qty	Order No.
	AP DK5		4036780000

**Notes**

Surge protection for instrumentation and control equipment

D



# ATEX certificates

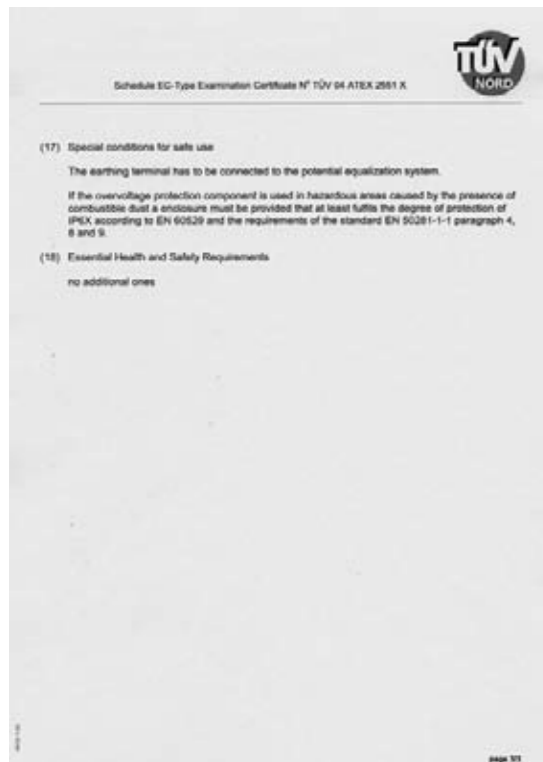





## Earthing of shielded lines

Electrical and electronic systems should be designed and installed so that they are essentially protected against electrical interference, so that they also function reliably in the event of transient interference voltages.

Electrical interference is introduced into circuits in many different ways. The most frequent cause is inductive interference effects. However, conductive or capacitive coupling plus electrical fields and other phenomena can also cause interference voltages. In these cases high-frequency voltage oscillations – the so-called transients – are very likely the cause of the interference.

### Shielded lines enhance interference immunity

The sources of interference voltages can never be eliminated completely. Therefore, we have to take measures to deal with their effects. Generally, it is true to say that the more effectively we can keep interference voltages away or discharge them from circuit elements, the smaller are their disturbing effects. This can be done in many ways – with differing degrees of effectiveness. One really effective measure, in particular for protecting against inductive influences, i.e. guaranteeing the electromagnetic compatibility, is to shield the electric functional components at earth potential. One way of doing this is to install components in metal, earthed housings and to shield the connecting lines.

Generally, it is true to say that counteracting the interference effects of lines is feasible by laying the lines as far apart as possible, keeping the common return as short as practical, or using twisted lines. A far better method of protection, however, is to provide a continuous shield for all lines. This is the most effective measure that can be taken against the coupling together of interferences.

The best form of shielding consists of a braided hose of individual wires made from a non-magnetic material (copper, aluminium). The braiding should be sufficiently robust and as solid as possible. Care must be taken with lines protected by a foil shield because of the foil's low mechanical strength and low current-carrying capacity.

### Correct use of shielded lines

Adding shielding to lines achieves the desired effect only when they are properly designed and installed. Incorrect earthing or the use of components that do not function satisfactorily reduce the effect or even nullify it altogether. It is not sufficient to connect the shielding to earth potential at just any point because it could be the case that this earth connection is inadequate for high frequencies. In addition, we must also watch out for earth loops, the shielding must be earthed over a large area, and the quality of the shield bonding lines and earthing accessories is also important.

### Effective earthing of the shielding



It is important to remember that the shielding should not be connected to the earth of the module connected, but rather to the protective earth (PE). In the case of modules mounted in an earthed, metal housing, the shielding must be connected to this housing. If an earthed housing is not available, the shielding must be connected to a separate earth.

When laying earth connections to shields it must also always be ensured that no earth loops are formed. The smaller the earth loop, the lower is the risk of inducing interference voltages. Therefore, a true star arrangement is the best answer.

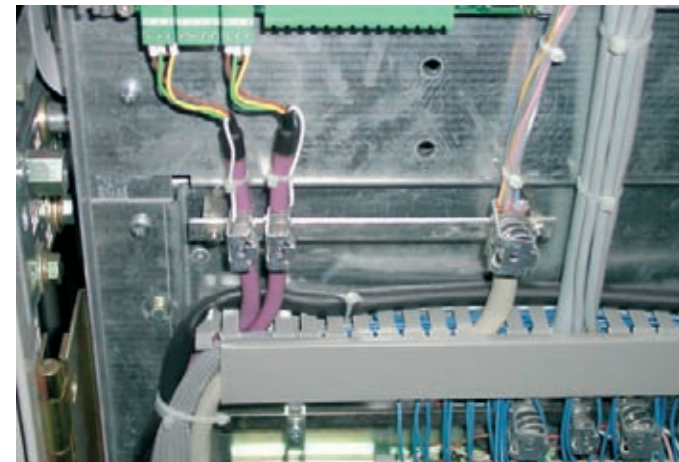

On longer shielded lines, e.g. when a sensor has to be routed to the control room, the potential difference between the two ends should not be ignored. If a current-carrying shield bonding line is used, it is possible to compensate for the potential difference between the measuring point and the control room by means of this shield. However, such shield lines are relatively expensive and also complicated to fabricate and install. Another possibility is to lay an additional equipotential bonding line between measuring point and control room. The shield can then be connected at both ends.

Yet another possibility is a high-resistance earth. The shield is then connected to earth potential in the control room, and at the measuring point connected to earth via a gas discharge tube in a high-resistance arrangement. This solves the problems of potential transfer and a 50 Hz hum. Two gas discharge tubes must be installed for non-floating measuring points. One connects the shield to earth and the other to the non-floating measuring point. This prevents conductive coupling between the measuring circuit and the earthed measuring point.

The sketches below show general, feasible connections between shield and protective earth.

Connecting the shield at one end protects against capacitive-coupled interference voltages.

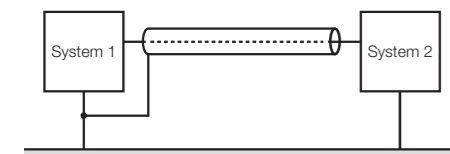

Connecting the shield at both ends is suitable for protecting against inductive-coupled interference fields.

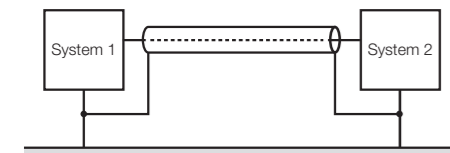

A high-resistance connection at one end of the shield is recommended when trying to avoid the disadvantages of forming an earth loop in the case of shields connected at both ends.

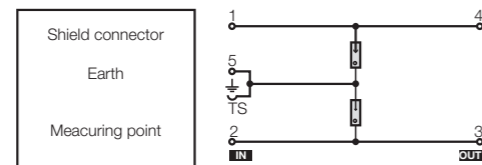
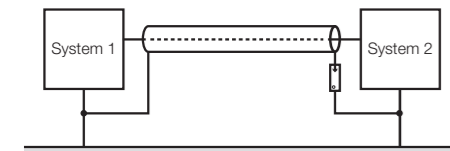

**Summary**

The earthing is an important factor affecting the reliable operation of electrical installations in the event of interference effects. RF aspects must be taken into account. Only the correct use of materials and well-thought-out circuit design can bring success.



## Installation advice for instrumentation and control engineering

The supply and earth lines to protective modules should be kept short in order to achieve optimum protection for equipment.

The fuses for the protective modules should be chosen depending on the rated current as well as on the type of line and its route.

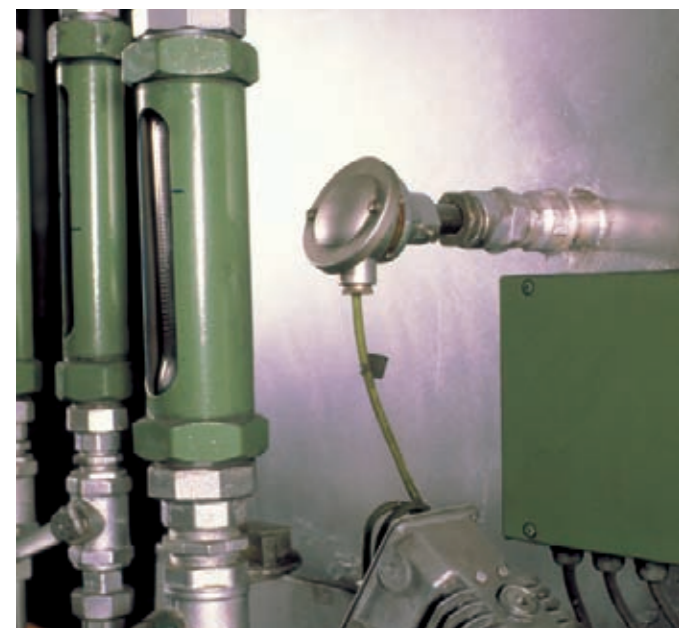

### Installation position

The protective modules are frequently installed at both ends of the line.

It is important to ensure that protected and unprotected lines are routed separately. In addition, there must be some distance between power lines and data lines. A common cable duct is to be subdivided with metal partitions.

The protective modules are to be mounted in a panel near the entry point of the lines. Unprotected lines should not be fed into parts of the system. Therefore, the lower level in the panel should be used for the protective modules.

### Mounting rail contact as earth in connection for MCZ OVP

Contact with the mounting rail is made automatically when the terminal is clipped on. To guarantee a safe energy discharge of up to 10 kA (8/20  $\mu$ s) via the MCZ terminals, the TS 35 rail must be earthed. The mounting rail should be screwed to an earthed mounting plate to comply with EMC requirements. In addition, it is possible to create the PE contact via the tension spring terminal of the MCZ OVP every 600 mm.

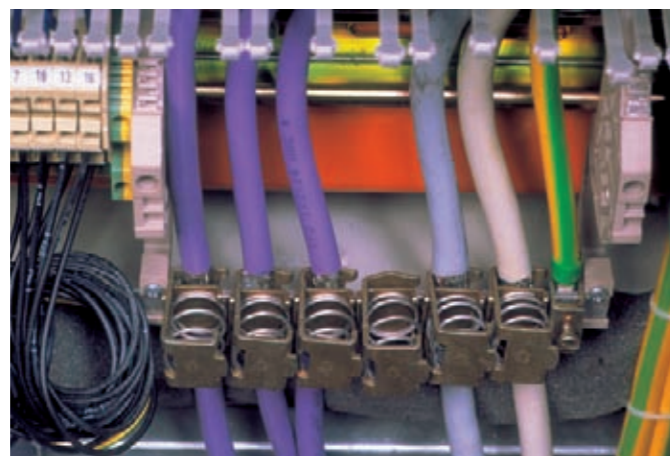

The shielded signal lines are to be connected to PE via terminal clamps (Weidmüller KLBÜ). Unshielded lines are to be twisted. Neutral earthing is to be preferred. All the protective modules belonging to one part of the system are to have neutral earthing. A through-connection of the earth line is to be avoided.

Protected and unprotected lines must be laid separately. A common cable duct is to be subdivided with metal partitions. Likewise, signal and power lines are to be laid separately. Electrical isolation, e.g. with relay couplers or analogue converters, should be employed for installations involving several buildings. This avoids interference currents via minus, PE or N.

The supply and earth lines to protective modules should be kept short in order to achieve optimum protection for equipment. Transmission paths should also be kept as short as possible because the longer the line, the greater is the chance that interference can affect the line. The inclusion of surge protection also increases the attenuation of the line and therefore changes the signal-to-noise ratio.

# Applications in instrumentation and control engineering

## Binary signals

Flow rate and direction are to be measured. To do this, a sensor can be incorporated up to approx. 150 m from the controller. This sensor is supplied with 24 Vdc and transmits binary signals for the velocity and direction of the flow to the controller.

With distances of up to 150 m, in exposed positions it is recommended to use surge protection both before the sensor and before the controller. An **MCZ OVP** terminal mounted on **TS 35** can be used. Clipping this on to the earthed **TS 35** simultaneously creates the earth connection.

The series gap in the **DK4U 940011** with a **GDT** ensures a high-resistance earth. Transient currents across the shielding are avoided. The **PU DS 852374** is installed in the supply voltage so that the controller is protected from the mains side. The PU II 230V is installed in the power supply so the controller is protected from the mains side. However, the PU III series must always be installed together with the PU II series.

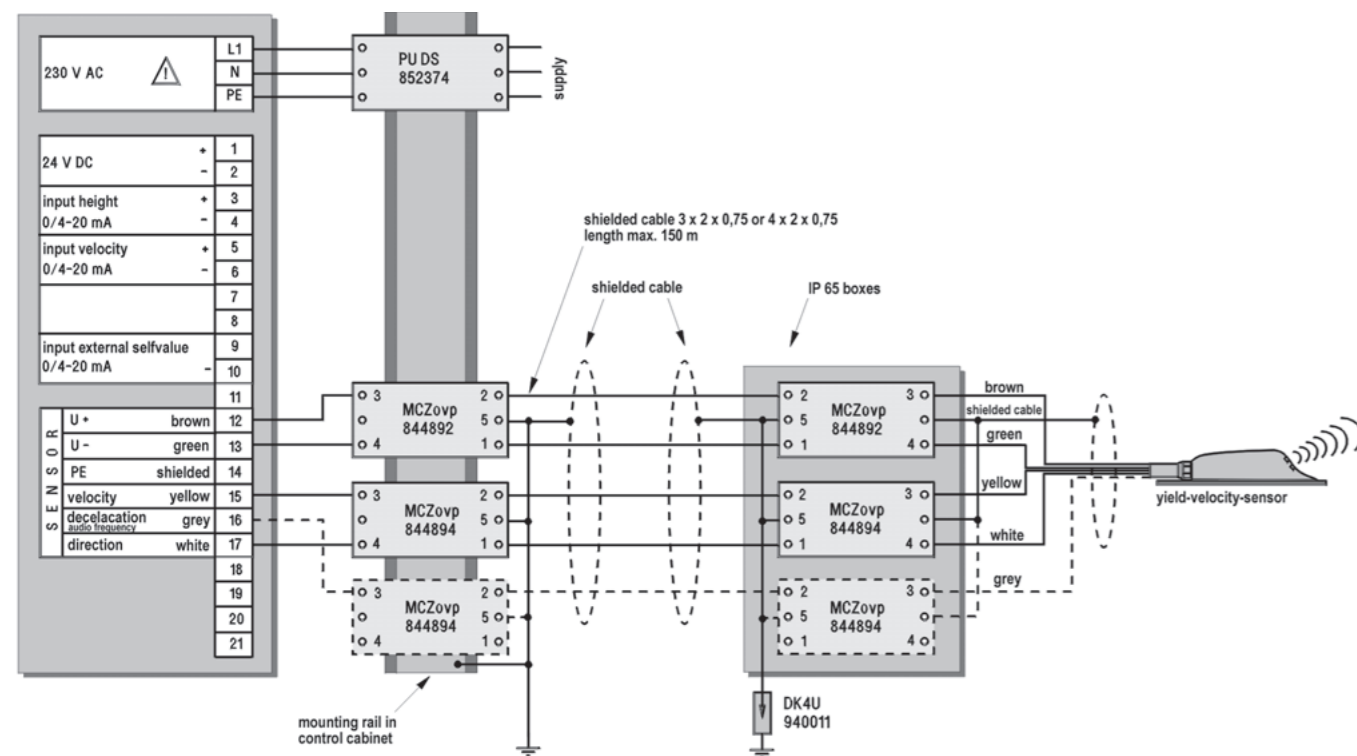
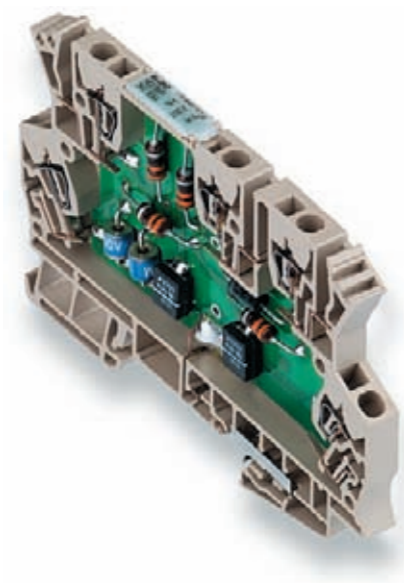



## Applications in instrumentation and control engineering

### Binary signals

Limit switches are used for monitoring the positions of moving machine parts in plants with harsh operating conditions, e.g. drives whose direction of rotation is reversed after the limit switch has been actuated.

Surge protection in the form of a modular terminal, **MCZ OVP SL 24 Vdc 0.5 A**, can protect two switching signals at the input of a controller. The discharge to earth of the coupled energy is achieved via gas discharge tube, varistor and high-speed suppression diode in each earth line.

The **PU DS 852374** is installed in the supply voltage so that the controller is protected from the mains side. The PU II 230V is installed in the power supply so the controller is protected from the mains side. However, the PU III series must always be installed together with the PU II series.

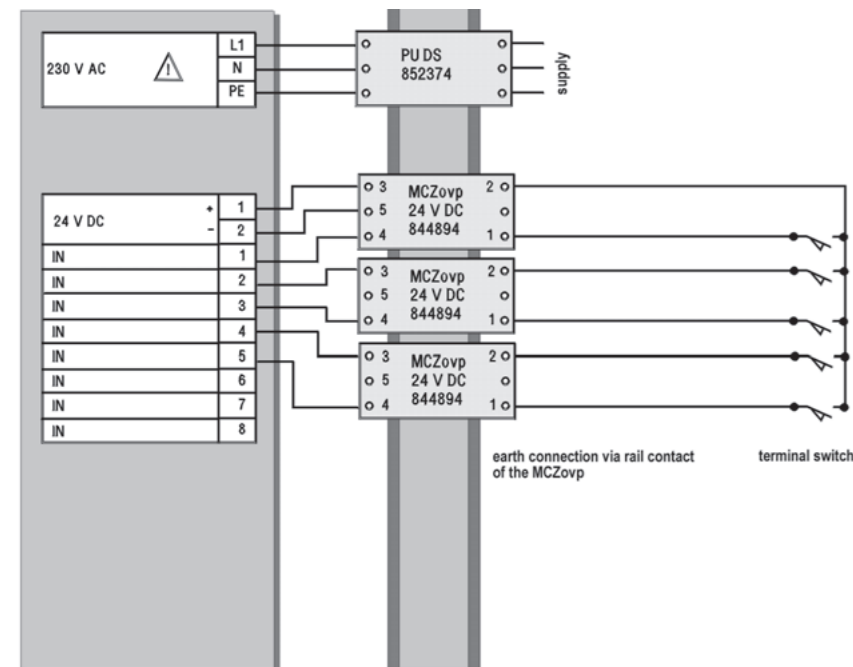
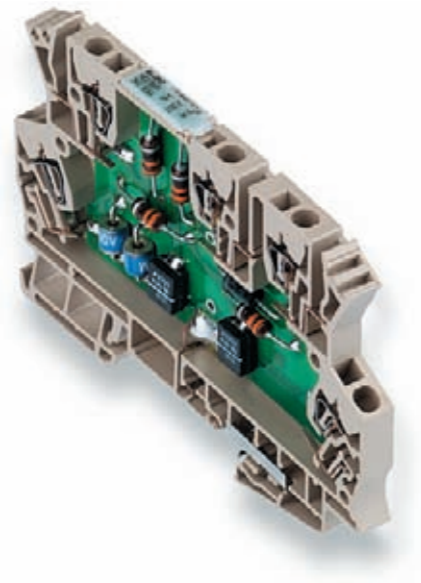

# Applications in instrumentation and control engineering

## 0...20 mA

The level in a vessel is to be measured. To do this, a sensor is supplied with 24 Vdc and sends an analogue 0...20 mA signal to the controller depending on the level.

The possibility of transmitting current signals over long distances means that in exposed positions it is recommended to incorporate surge protection both before the sensor and before the controller. An **MCZ OVP** terminal mounted on **TS 35** can be used. Clipping this on to the earthed **TS 35** simultaneously creates the earth connection.

The series gap in the **DK4U 940011** with a **GDT** ensures a high-resistance earth. Transient currents across the shielding are avoided. The **PU DS 852374** is installed in the supply voltage so that the control is protected from the mains side.

The **PU II 230 V** is installed in the power supply so the controller is protected from the mains side. However, the **PU III series** must always be installed together with the **PU II series**.

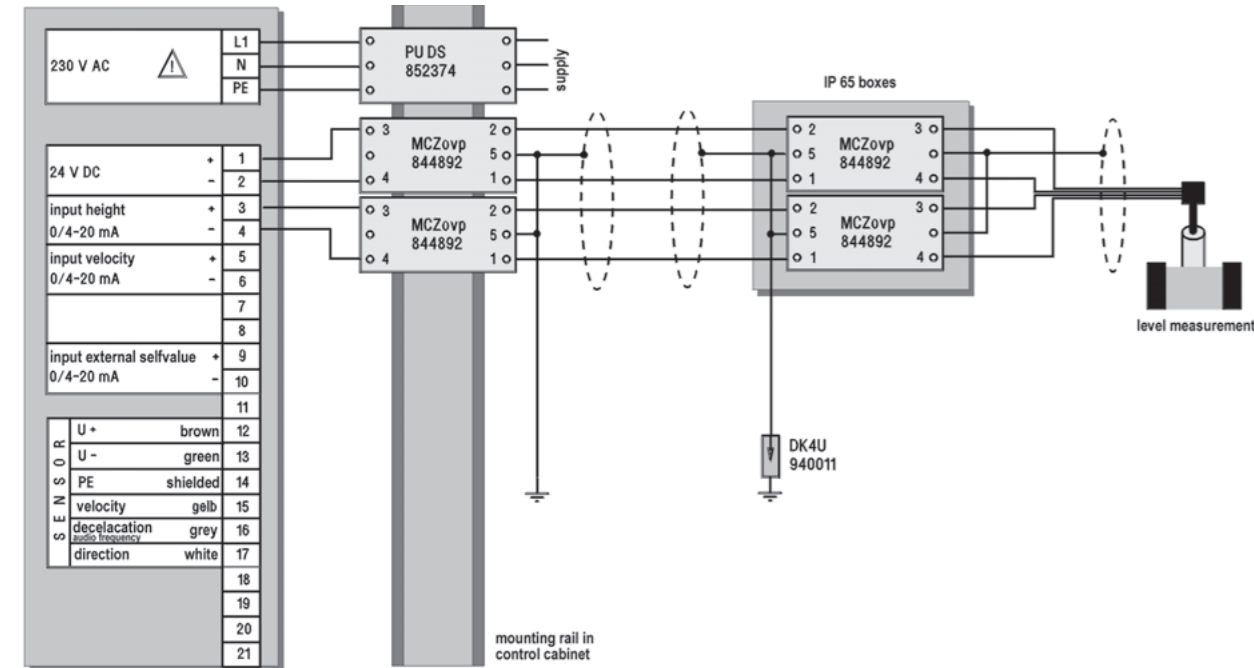
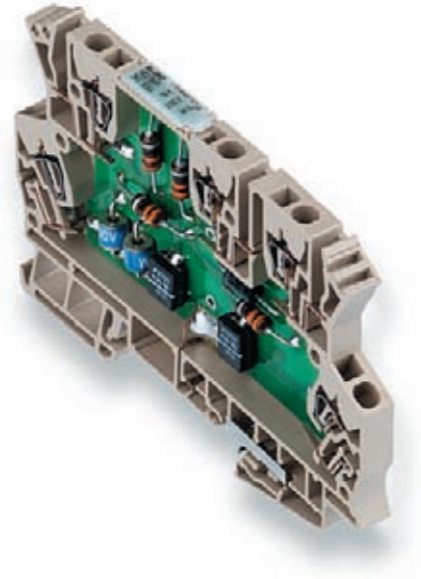



## Applications in instrumentation and control engineering

### Measuring temperatures with a thermocouple

Temperatures exceeding 1000 °C are to be measured using thermocouples. The thermocouple consists of two dissimilar metals and is connected unearthed to the measuring transducer. It is important that the surge protection is also installed unearthed. This is achieved with the **LPU 0.1 A** surge protection. This board is inserted in the **SEG-U** housing. The **LPU 0.1 A** surge protection provides a high-resistance coupling between the sensor lines and earth via gas discharge tubes and, in addition, provides protection between the lines by means of varistors and high-speed suppression diodes.

The **PU DS 852374** is installed in the supply voltage so that the controller is protected from the mains side. The **PU II 230 V** is installed in the power supply so the controller is protected from the mains side. However, the **PU III series** must always be installed together with the **PU II series**.

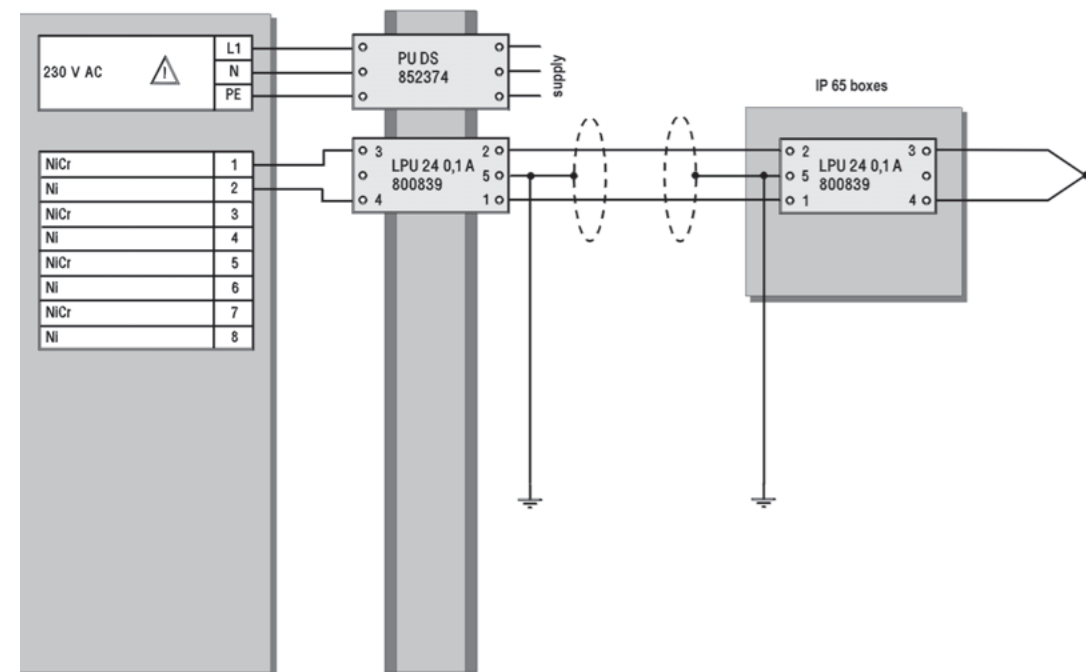
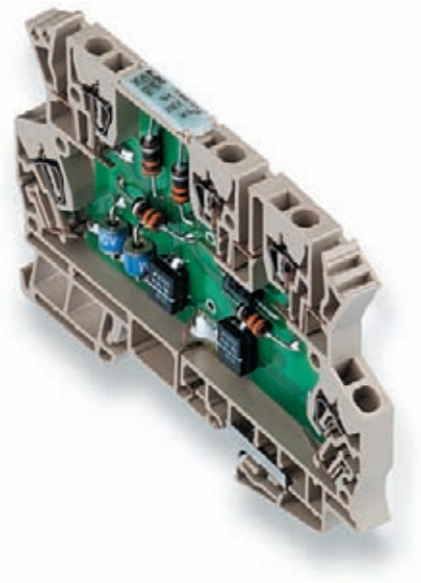

# Surge protection for data interfaces

<b>Surge protection for data interfaces</b>	Surge protection fundamentals for data signals	E.2
	Surge protection for data interfaces	E.4
	Surge protection for telecommunications interfaces	E.12
	Installation instructions for data interfaces	E.15
	Applications for data surge protection / <b>LON</b> <sup>™</sup> termination	E.16
	Applications for data surge protection / RS485	E.17
	<b>LON</b> <sup>™</sup> application	E.19

E



# Surge protection for data interfaces

## The principles of data transmission

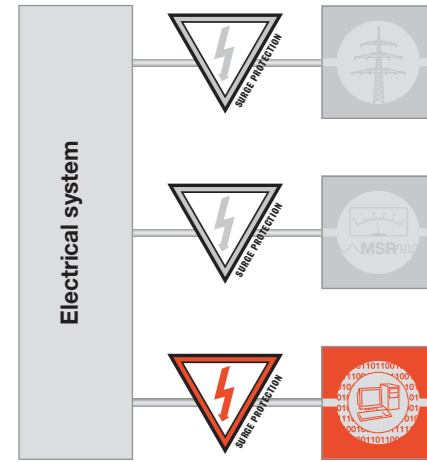

"Data transmission" is the name given to the sending of characters, numbers, statuses and measurements between different, decentralised units. Decentralised units are, for example, controls, computers, measuring sensors, actuators, etc. One unit transmits the data, the second unit receives it. This corresponds to the simplest method of data transmission. It is often necessary for one unit to receive data and then send an "answer" back to the other unit. Two data lines in a back-to-back arrangement are required for this, or data lines are combined by providing each end of the data line with a transmitter and receiver.

### Structures and properties of networks

There are various options for networking data terminals. We distinguish between star, ring, point-to-point and bus networks.

#### Star networks

The main unit is located in the centre. The individual data lines then radiate out from this centre to the individual terminals. In this system all data terminals are connected to the central terminal via their own cable.

#### Ring networks

The computers or data terminals are all connected to each other like a chain by means of, for example, coaxial cable. In this case the data is passed on from one data terminal to the next. Therefore, the entire ring is always under load. The advantage of the ring network is that it can cover a larger area than a star network because the length of the transmission path is only ever the distance between two adjacent data terminals.

#### Point-to-point networks

These are basically networks between two data terminals that are connected directly with each other, e.g. an RS 232 or RS 422 link.

#### Bus networks

These are networks based on the parallel connection of modules. All components operate on one and the same line. Therefore, only two/four wires are required for the data bus. If bus cabling includes branches, then we call that a tree structure. Every bus system includes a bus controller that issues "transmission licences" to the individual data terminals.

#### Transmission media

In order to be able to send any data at all, data lines are necessary:

#### Two- and three-wire systems

Data transmissions requiring relatively low transmission rates can make use of two-wire systems. For example, an ISDN system acting as an exchange line to a building requires only two wires. However, other types of bus systems also require only two or three wires.

#### Four-wire systems

This is the current standard for the majority of corporate data networks. Two wires are used for transmitting data and two for receiving. These cables are well shielded and can transmit data with frequencies of up to 500 MHz over distances of up to 100 m.

#### Coaxial cable

Sending data via coaxial cables is a rather old technique. This method is too slow and inflexible and so only a few businesses are still using such systems. Speeds of up to about 12 Mbps are no longer adequate these days. Over longer distances, modern fibre-optic cables are replacing this technology; these can transmit several hundred Mbps.

#### Serial interfaces

A serial interface operates with 8 data bits (1 byte). A start bit (low bit) is always sent before the output of a byte, and one or two stop bits (high bits) are appended to the end of the byte. This encryption is critical for the data receiver as it can then detect where each data byte begins and ends. Serial interfaces frequently operate with +5 V (logical 1) and 0 V (logical 0). Advantage: less cabling (only 3 wires). Disadvantage: slow data transmission.



**RS232**

Serial interface for point-to-point connections up to 20 kbit/s  
Voltage signal to earth:  
logic 1 (mark) -15 V to -3 V  
logic 0 (space) +3 V to +15 V  
max. signal level ±15 V  
Lines up to 20 m long depending on transmission rate.

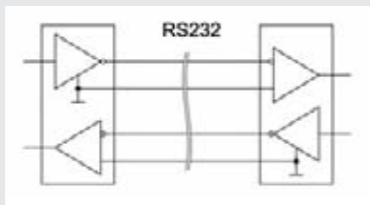

Protective module in adapter plug housing  
RS232-8 B/S25  
RS232-8 S/B25

**Page E.4**  
**Page E.4**

Protective module in housing for fitting to mounting rail  
EGU4 EG3 RS232

**Page E.4**

**RS422**

Serial unidirectional high-speed interface for up to 10 parallel receivers  
Differential voltage signal:  
logic 1 (mark) A-B < -0.3 V  
logic 0 (space) A-B > +0.3 V  
max. signal level ±12 V  
Lines up to 1200 m long  
max. data rate 10 Mbit/s

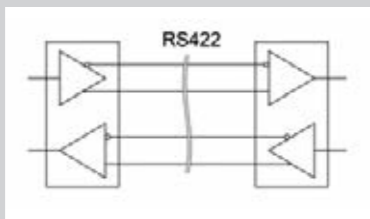

Protective module in housing for fitting to mounting rail  
LPU RS422 / RS485

**Page E.5**

Protective module in housing for fitting to mounting rail  
RS 485 K21 / RS 422

**Page E.5**

**RS485**

Serial bidirectional high-speed interface for up to 32 subscribers  
2- or 4-wire system  
Differential voltage signal:  
logic 1 (mark) A-B < -0.3 V  
logic 0 (space) A-B > +0.3 V  
max. signal level -7 V to +12 V  
Lines up to 1200 m long  
max. data rate 10 Mbit/s

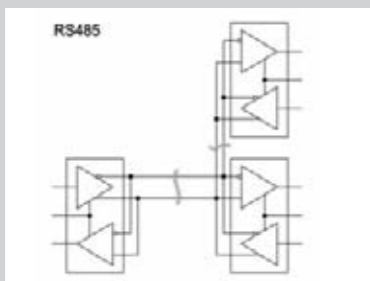

**LON™ (twisted pair)**

Series bus with TP/XF-78 (old)  
Series bus with TP/XF-1250  
Series bus or free topology with TP/FT-10  
Series bus or free topology with LPT-10  
EIB (European Installation Bus)  
Twisted pair or power line  
Series, star-type or tree bus  
(also combinations thereof) 9600 bit/s  
Building services automation

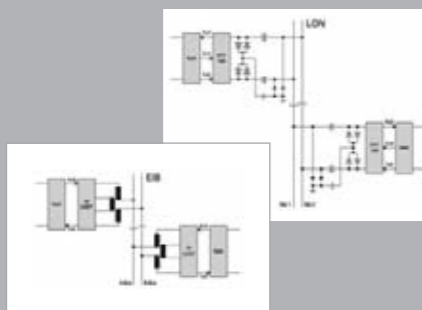

Protective module in housing for fitting to mounting rail  
MCZ sp LON-Bus

**Page E.6**

LON™ termination  
DIALOC BUS TERMINATION

**Page E.6**

Ethernet Cat.5

**Page E.7**

**COAX**

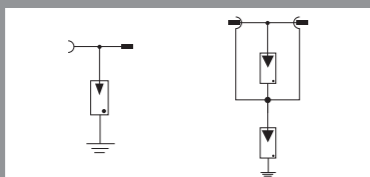

Protective module for BNC- and N-cables

**Page E.8**

Protective module for F- and UHF-cables

**Page E.9**

E



Surge protection for data interfaces

RS232

RS 232

RS 232

EGU 4 RS232

RS232 adapter plug

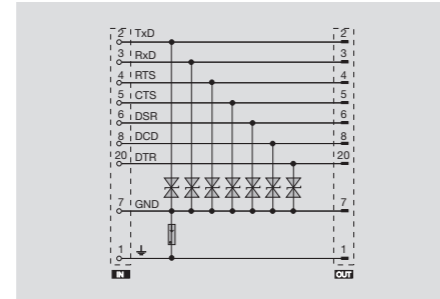
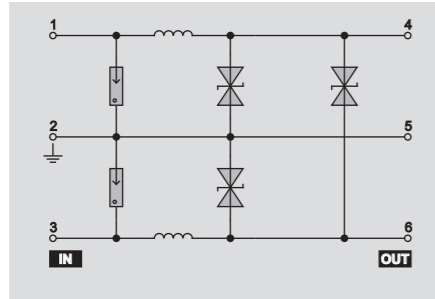

Technical data

<b>Technical data</b>	
Rated voltage (AC)	12 V
max. continuous voltage, U <sub>c</sub> (AC)	14.5 V
Operating current, I <sub>max</sub>	0.1 A
Volume resistivity	1.30 Ω
Build rate	≤ 9600 Bd
Response time	≤ 5 ns
Gas discharge tube	yes
Varistor	no
Suppression diodes	yes
Cut-off frequency (-3 dB) at load impedance	30.0 kHz 600Ω
Discharge current, max. (8/20 μs)	5 kA
Protection level on output side sym., input 1 kV/μs, typ.	20 V
Protection level on output side sym., input 8/20 μs, typ.	32 V
Protection level on output side unsym., input 1kV/μs, typ.	20 V
Protection level on output side unsym., input 8/20 μs, typ.	32 V
Design	integral housing
Type of connection	Screw connection
Ambient temperature (operational)	-25 ... 60°C
Storage temperature	-25 ... 85°C

<b>Technical data</b>	
Rated voltage (AC)	12 V
max. continuous voltage, U <sub>c</sub> (AC)	14.5 V
Operating current, I <sub>max</sub>	0.1 A
Volume resistivity	1.30 Ω
Build rate	≤ 9600 Bd
Response time	≤ 5 ns
Gas discharge tube	yes
Varistor	no
Suppression diodes	yes
Cut-off frequency (-3 dB) at load impedance	30.0 kHz 600Ω
Discharge current, max. (8/20 μs)	5 kA
Protection level on output side sym., input 1 kV/μs, typ.	20 V
Protection level on output side sym., input 8/20 μs, typ.	32 V
Protection level on output side unsym., input 1kV/μs, typ.	20 V
Protection level on output side unsym., input 8/20 μs, typ.	32 V
Design	integral housing
Type of connection	Screw connection
Ambient temperature (operational)	-25 ... 60°C
Storage temperature	-25 ... 85°C

<b>Technical data</b>	
Rated voltage (AC)	12 V
max. continuous voltage, U <sub>c</sub> (AC)	15 V
Operating current, I <sub>max</sub>	0.1 A
Volume resistivity	1.00 Ω
Build rate	≤ 19200 Bd
Response time	≤ 5 ns
Gas discharge tube	yes
Varistor	no
Suppression diodes	yes
Cut-off frequency (-3 dB) at load impedance	30.0 kHz 1200Ω
Discharge current, max. (8/20 μs)	0.5 kA
Protection level on output side sym., input 1 kV/μs, typ.	20 V
Protection level on output side sym., input 8/20 μs, typ.	28 V
Protection level on output side unsym., input 1kV/μs, typ.	20 V
Protection level on output side unsym., input 8/20 μs, typ.	28 V
Design	adapter plug
Type of connection	Screw connection
Ambient temperature (operational)	-20 ... 55°C
Storage temperature	-40 ... 60°C

<b>Dimensions</b>	
Clamping range (rating- / min. / max.)	mm <sup>2</sup>
Length x width x height	mm

<b>Dimensions</b>	
Clamping range (rating- / min. / max.)	mm <sup>2</sup>
Length x width x height	mm

<b>Dimensions</b>	
Clamping range (rating- / min. / max.)	mm <sup>2</sup>
Length x width x height	mm

**Note**

**Note**

**Note**

Ordering data

<b>Version</b>	
----------------	--

Type	Qty.	Order No.
EGU4 EG3 RS232 DATENLTG	1	1170460000

Type	Qty.	Order No.
RS232-8 B/S25	1	8570500000
RS232-8 S/B25	1	8570510000

**Note**

**Note**

**Note**

Accessories

**Note**

**Note**

**Note**

RS 485

RS485/RS422 surge protection

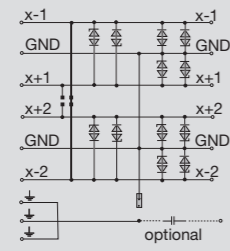

RS 485

RS485/RS422 plug-in surge protection

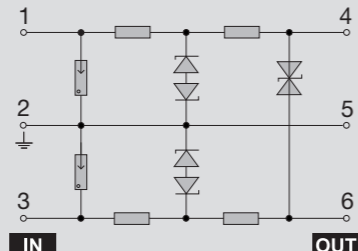

Surge protection for data interfaces



Technical data

Rated voltage (AC)	12 V
max. continuous voltage, U <sub>c</sub> (AC)	12 V
Operating current, I <sub>max</sub>	1.5 A
Volume resistivity	0.50 Ω
Build rate	≤ 6 MB
Response time	≤ 5 ns
Gas discharge tube	yes
Varistor	no
Suppression diodes	yes
Cut-off frequency (-3 dB) at load impedance	1.5 MHz / 100 Ω-System max.
Discharge current, max. (8/20 μs)	5 kA
Protection level on output side sym., input 1 kV/μs, typ.	18 V
Protection level on output side sym., input 8/20 μs, typ.	28 V
Protection level on output side unsym., input 1kV/μs, typ.	18 V
Protection level on output side unsym., input 8/20 μs, typ.	28 V
Design	Miscellaneous
Type of connection	Screw connection
Ambient temperature (operational)	-25 ... 60°C
Storage temperature	-25 ... 85°C

Rated voltage (AC)	12 V
max. continuous voltage, U <sub>c</sub> (AC)	12 V
Operating current, I <sub>max</sub>	1.5 A
Volume resistivity	0.50 Ω
Build rate	≤ 6 MB
Response time	≤ 5 ns
Gas discharge tube	yes
Varistor	no
Suppression diodes	yes
Cut-off frequency (-3 dB) at load impedance	1.5 MHz / 100 Ω-System max.
Discharge current, max. (8/20 μs)	5 kA
Protection level on output side sym., input 1 kV/μs, typ.	18 V
Protection level on output side sym., input 8/20 μs, typ.	28 V
Protection level on output side unsym., input 1kV/μs, typ.	18 V
Protection level on output side unsym., input 8/20 μs, typ.	28 V
Design	Miscellaneous
Type of connection	Screw connection
Ambient temperature (operational)	-25 ... 60°C
Storage temperature	-25 ... 85°C

Rated voltage (AC)	6 V
max. continuous voltage, U <sub>c</sub> (AC)	12 V
Operating current, I <sub>max</sub>	1.5 A
Volume resistivity	12.00 Ω
Build rate	≤ 5 ns
Response time	≤ 5 ns
Gas discharge tube	yes
Varistor	no
Suppression diodes	yes
Cut-off frequency (-3 dB) at load impedance	1.5 MHz / 100 Ω-System max.
Discharge current, max. (8/20 μs)	5 kA
Protection level on output side sym., input 1 kV/μs, typ.	18 V
Protection level on output side sym., input 8/20 μs, typ.	36 V
Protection level on output side unsym., input 1kV/μs, typ.	18 V
Protection level on output side unsym., input 8/20 μs, typ.	36 V
Design	Plug-in card
Type of connection	Plug-in connection
Ambient temperature (operational)	-25 ... 60°C
Storage temperature	-25 ... 85°C

Dimensions

Clamping range (rating- / min. / max.)	mm <sup>2</sup>	1.5 / 0.5 / 4
Length x width x height	mm	125 x 80 x 57

Screw connection

Clamping range (rating- / min. / max.)	mm <sup>2</sup>	1.5 / 0.5 / 4
Length x width x height	mm	125 x 80 x 57

Plug-in connection

Clamping range (rating- / min. / max.)	mm <sup>2</sup>	1.5 / 0.5 / 4
Length x width x height	mm	96.6 x 20 x 117

Ordering data

Version	Type	Qty.	Order No.
	RS 485 K21 UE-SCHUTZ SE	1	8008501001

Type	Qty.	Order No.
RS 485 K21 UE-SCHUTZ SE	1	8008501001

Version	Type	Qty.	Order No.
	LPU RS 485	1	9454930000

Type	Qty.	Order No.
LPU RS 485	1	9454930000

Note

--

--

Accessories

--

--

Housing SEG-U 8007871001
--------------------------

Surge protection for data interfaces

LON™

LON FTT / TP78

Dialoc termination

Protection for LonWorks signals

Bus terminator for LonWorks signals

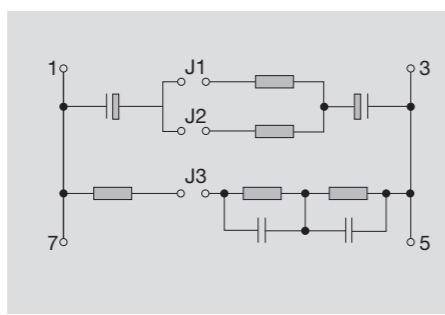
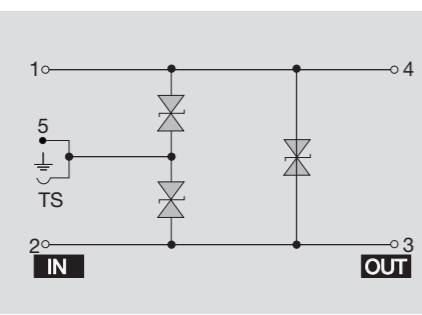
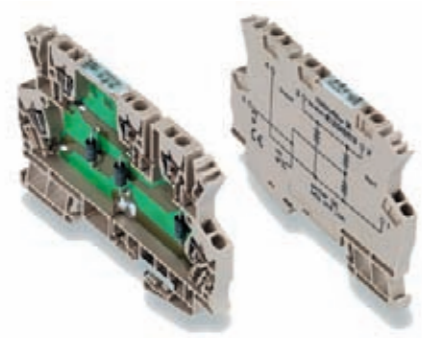

Technical data

<b>Technical data</b>	
Rated voltage (AC)	12 V
max. continuous voltage, U <sub>c</sub> (AC)	14 V
Operating current, I <sub>max</sub>	16 A
Volume resistivity	0.50 Ω
Build rate	
Response time	≤ 100 ps
Gas discharge tube	no
Varistor	no
Suppression diodes	yes
Cut-off frequency (-3 dB) at load impedance	
Discharge current, max. (8/20 μs)	0.1 kA
Protection level on output side sym., input 1 kV/μs, typ.	20 V
Protection level on output side sym., input 8/20 μs, typ.	32 V
Protection level on output side unsym., input 1kV/μs, typ.	20 V
Protection level on output side unsym., input 8/20 μs, typ.	32 V
Design	terminal
Type of connection	tension clamp connection
Ambient temperature (operational)	-25 ... 55°C
Storage temperature	-25 ... 60°C

<b>Technical data</b>	
Rated voltage (AC)	12 V
max. continuous voltage, U <sub>c</sub> (AC)	14 V
Operating current, I <sub>max</sub>	16 A
Volume resistivity	0.50 Ω
Build rate	
Response time	≤ 100 ps
Gas discharge tube	no
Varistor	no
Suppression diodes	yes
Cut-off frequency (-3 dB) at load impedance	
Discharge current, max. (8/20 μs)	0.1 kA
Protection level on output side sym., input 1 kV/μs, typ.	20 V
Protection level on output side sym., input 8/20 μs, typ.	32 V
Protection level on output side unsym., input 1kV/μs, typ.	20 V
Protection level on output side unsym., input 8/20 μs, typ.	32 V
Design	terminal
Type of connection	tension clamp connection
Ambient temperature (operational)	-25 ... 55°C
Storage temperature	-25 ... 60°C

<b>Technical data</b>	
Rated voltage (AC)	48 V
max. continuous voltage, U <sub>c</sub> (AC)	60 V
Operating current, I <sub>max</sub>	16 A
Volume resistivity	0.50 Ω
Build rate	
Response time	
Gas discharge tube	no
Varistor	no
Suppression diodes	no
Cut-off frequency (-3 dB) at load impedance	
Discharge current, max. (8/20 μs)	
Protection level on output side sym., input 1 kV/μs, typ.	
Protection level on output side sym., input 8/20 μs, typ.	
Protection level on output side unsym., input 1kV/μs, typ.	
Protection level on output side unsym., input 8/20 μs, typ.	
Design	terminal
Type of connection	Screw connection
Ambient temperature (operational)	-25 ... 55°C
Storage temperature	-25 ... 60°C

Dimensions

Clamping range (rating- / min. / max.)	mm²	1.5 / 0.5 / 1.5
Length x width x height	mm	91 x 6 x 63.2

<b>tension clamp connection</b>		
Clamping range (rating- / min. / max.)	mm²	1.5 / 0.5 / 1.5
Length x width x height	mm	91 x 6 x 63.2

<b>Screw connection</b>		
Clamping range (rating- / min. / max.)	mm²	2.5 / 0.5 / 4
Length x width x height	mm	65 x 12 x 57

Ordering data

Version

Type	Qty.	Order No.
MCZ OVP LON-Bus	10	8473470000

Type	Qty.	Order No.
DIALOC BUS TERMINATION Abschluss 5	5	8496110000

**Note**

LON is a trademark of Echolon

Select termination LPT/FTT/TP78 via jumper

Accessories

**Note**



**Cat.5 surge protection**

- Connection via RJ 45 sockets
- Protection for all signal lines
- Suitable for 10BaseTx and 100BaseTx
- PE connection via M4 screw

**DME 100Tx-4RJ**

Ethernet Cat.5



**DME 100Tx-4RJ TS 35**

Ethernet Cat.5



Surge protection for data interfaces

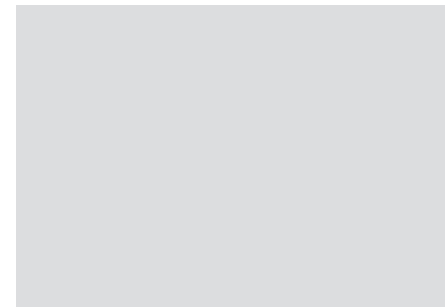

**Technical data**

Technical data	DME 100Tx-4RJ	DME 100Tx-4RJ TS 35
Rated voltage (AC)	5 V	5 V
max. continuous voltage, U <sub>c</sub> (AC)	7 V	7 V
Operating current, I <sub>max</sub>		
Volume resistivity	1.30 Ω	1.30 Ω
Build rate		
Response time	≤ 5 ns	≤ 5 ns
Gas discharge tube	yes	yes
Variistor	no	no
Suppression diodes	yes	yes
Cut-off frequency (-3 dB) at load impedance		
Discharge current, max. (8/20 μs)	2 kA	2 kA
Protection level on output side sym., input 1 kV/μs, typ.	40 V	40 V
Protection level on output side sym., input 8/20 μs, typ.	45 V	45 V
Protection level on output side unsym., input 1kV/μs, typ.	450 V	450 V
Protection level on output side unsym., input 8/20 μs, typ.	500 V	500 V
Design	Miscellaneous	Miscellaneous
Type of connection	RJ45	RJ45
Ambient temperature (operational)	-20 ... 50°C	-20 ... 50°C
Storage temperature	-25 ... 60°C	-25 ... 60°C

**Dimensions**

Dimensions	RJ45	RJ45
Clamping range (rating- / min. / max.)		
Length x width x height	51 x 47 x 22	55 x 64 x 22

Note	Data line protection for 10BaseT and 100BaseT	Data line protection for 10BaseT and 100BaseT
------	---	---

**Ordering data**

Version	Type	Qty.	Order No.	Type	Qty.	Order No.
	DME 100Tx-4RJ	1	8738780000	DME 100Tx-4RJ TS35 Ether. Cat5	1	8830230000

Note		
------	--	--

**Accessories**

Note		
------	--	--

**Surge protection for data interfaces**

**Coax surge protection**

- Surge protection for COAX data networks
- Metal housings
- Surge protection using gas-filled arrestor
- Easy handling using socket-adaptor function, with minimal attenuation

**BNC Connector / M-F**

Protection for video monitoring systems

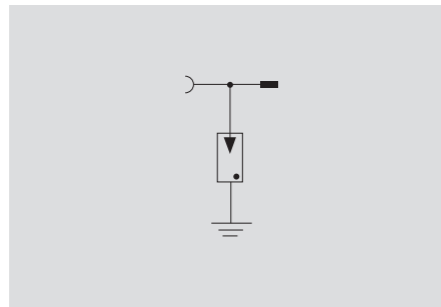

**N Connector / M-F**

Protection for transmitters, GSM

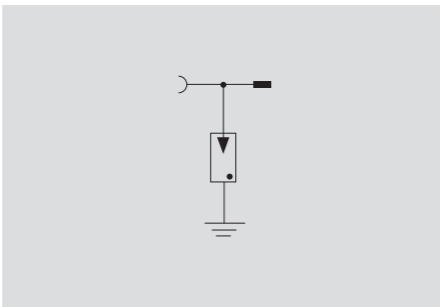

**Technical data**

Transmission capacity, max.	40 W
max. continuous voltage, U <sub>c</sub> (DC)	90 V ± 20 %
Characteristic impedance	50 Ω
Frequency range	0...2.5 GHz
Operating current, I <sub>max</sub>	5 A
Insertion loss (attenuation)	< 0.2 dB
Return loss (attenuation)	> 20 dB
VSWR	< 1.2
Specification class to IEC 61643-21	C1;C2;C3;D1
Lightning test voltage I <sub>imp</sub> (10/350 μs)	5 kA
Discharge current, max. (8/20 μs)	20 kA
Response time	< 100 ns
Protection level Up (typical)	< 600 V
Earthing	Required with M6 screw
Type of connection	Male / Female
Version	adapter plug
Ambient temperature (operational)	-40 ... 80°C

Transmission capacity, max.	40 W
max. continuous voltage, U <sub>c</sub> (DC)	90 V ± 20 %
Characteristic impedance	50 Ω
Frequency range	0...2.5 GHz
Operating current, I <sub>max</sub>	5 A
Insertion loss (attenuation)	< 0.2 dB
Return loss (attenuation)	> 20 dB
VSWR	< 1.2
Specification class to IEC 61643-21	C1;C2;C3;D1
Lightning test voltage I <sub>imp</sub> (10/350 μs)	5 kA
Discharge current, max. (8/20 μs)	20 kA
Response time	< 100 ns
Protection level Up (typical)	< 600 V
Earthing	Required with M6 screw
Type of connection	Male / Female
Version	adapter plug
Ambient temperature (operational)	-40 ... 80°C

Transmission capacity, max.	25 W
max. continuous voltage, U <sub>c</sub> (DC)	90 V ± 20 %
Characteristic impedance	50 Ω
Frequency range	0...2.5 GHz
Operating current, I <sub>max</sub>	5 A
Insertion loss (attenuation)	< 0.15 dB
Return loss (attenuation)	> 20 dB
VSWR	< 1.2
Specification class to IEC 61643-21	C1;C2;C3;D1
Lightning test voltage I <sub>imp</sub> (10/350 μs)	5 kA
Discharge current, max. (8/20 μs)	20 kA
Response time	< 100 ns
Protection level Up (typical)	< 600 V
Earthing	Required with M6 screw
Type of connection	Male / Female
Version	adapter plug
Ambient temperature (operational)	-40 ... 80°C

<b>Dimensions</b>	
Clamping range (rating- / min. / max.)	mm²
Length x width x height	mm

<b>Male / Female</b>	
Length x width x height	66.3 x 25

<b>Male / Female</b>	
Length x width x height	80.3 x 25

**Ordering data**

Version	Type	Qty.	Order No.
adapter plug	BNC Connector / M-F	1	8947820000

Type	Qty.	Order No.
BNC Connector / M-F	1	8947820000

Type	Qty.	Order No.
N Connector / M-F	1	8947830000

<b>Note</b>
-------------

<b>Note</b>
-------------

<b>Note</b>
-------------

**Accessories**

<b>Note</b>
-------------

<b>Note</b>
-------------

<b>Note</b>
-------------

**Coax surge protection**

- Surge protection for COAX data networks
- Metal housings
- Surge protection using gas-filled arrestor
- Easy handling using socket-adaptor function, with minimal attenuation

**F Connector / M-F**

Protection for satellite systems



**UHF Connector / M-F**

Protection for terrestrial TV

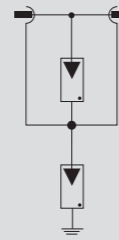
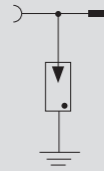

E



**Technical data**

Technical data	F Connector / M-F	UHF Connector / M-F
Transmission capacity, max.	25 W	
max. continuous voltage, U <sub>c</sub> (DC)	90 V ± 20 %	75 V ± 20 %
Characteristic impedance	75 Ω	75 Ω
Frequency range	0...2.5 GHz	0...1 GHz
Operating current, I <sub>max</sub>	5 A	4 A
Insertion loss (attenuation)	< 0.5 dB	< 0.3 dB
Return loss (attenuation)	> 20 dB	> 20 dB
VSWR	< 1.3	
Specification class to IEC 61643-21	C1;C2;C3;D1	C1;C2;C3;D1
Lightning test voltage I <sub>imp</sub> (10/350 μs)	5 kA	-
Discharge current, max. (8/20 μs)	20 kA	20 kA
Response time	< 100 ns	< 100 ns
Protection level Up (typical)	< 600 V	< 600 V
Earthing	Required with M6 screw	Required with 1.5mm <sup>2</sup> connection cable
Type of connection	Male / Female	Male / Female
Version	adapter plug	adapter plug
Ambient temperature (operational)	-40 ... 80°C	-40 ... 80°C

**Dimensions**

Dimensions	Male / Female	Male / Female
Clamping range (rating- / min. / max.)		
Length x width x height	51.8 x 25	48 x 43 x 24

Note		

**Ordering data**

Version	Type	Qty.	Order No.	Type	Qty.	Order No.
adapter plug	F Connector / M-F	1	8947840000	UHF Connector / M-F	1	8947850000

Note		

**Accessories**

Note		

BNC Connector / M-F

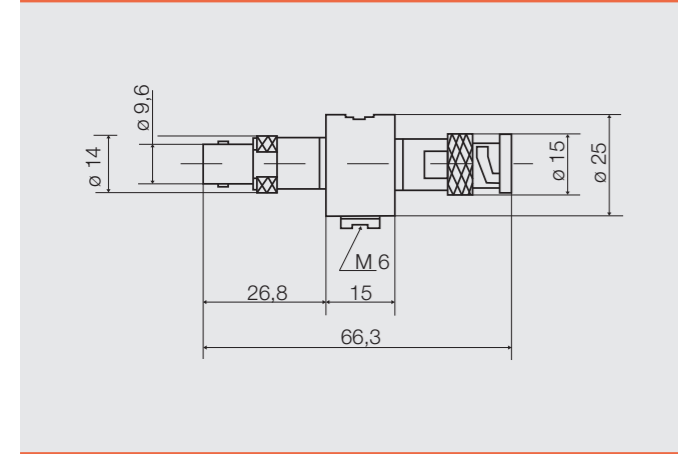

N Connector / M-F

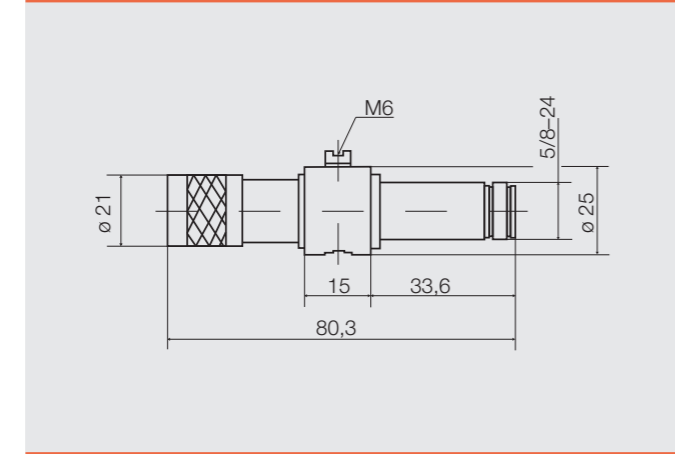

F Connector / M-F

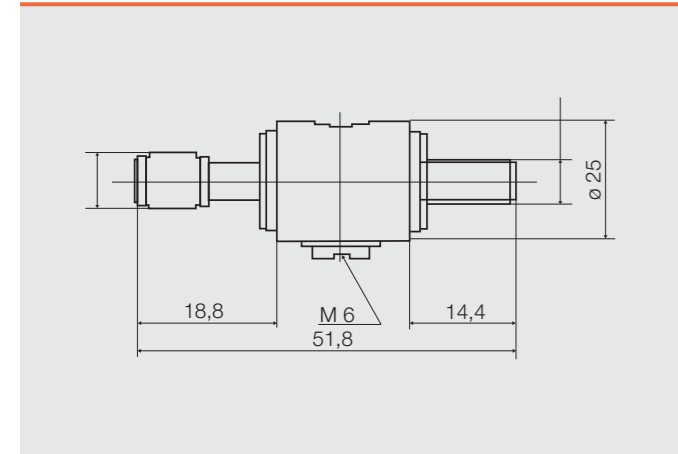

UHF Connector / M-F

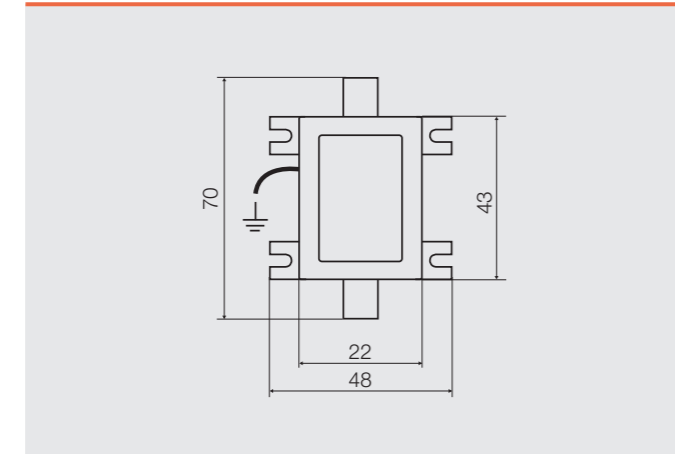



# Surge protection for TAE telecommunications interfaces

## Surge protection for analogue connections

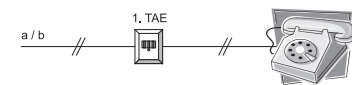

Besides the use of standard telephones, an analogue installation can also be used to transmit data services like fault signalling systems and Internet. The fact that besides telephones other devices like fax machines and modems are also connected to the analogue line means that the hazards due to transient interference phenomena like surges are on the increase.

TAE surge protection for analogue lines is necessary to achieve protection against these surges. The basic version of the surface-mounted TAE-NFN socket has two-stage surge protection provided by a gas discharge tube and fast-acting suppression diodes.

The gas discharge tube achieves a high energy discharge; the suppression diodes ensure a low residual voltage. This setup protects the end terminals. Other TAE surge protection sockets with monitoring functions are also available.

These monitor the connection of the voice voltage/operating voltage. As soon as this is interrupted or short-circuited, the output is switched to high resistance. This signal can be evaluated via a PLC input. A visual indication (green LED) instead of the remote signalling can be selected as an option.

### Installation instructions

The incoming telephone line must be connected with the right polarity La (-) / Lb (+). The connection of the operating voltage for the UK0 interface is monitored (transistor output is enabled). As soon as this is interrupted or short-circuited, the output is switched to high resistance. This signalling voltage of the TAE SP ISDN FM can be evaluated via a PLC input.

On the TAE SP ISDN LED model an LED indicates the operating status.

## Surge protection for ISDN connections

### Telephone connections at the U<sub>k0</sub>/So interface

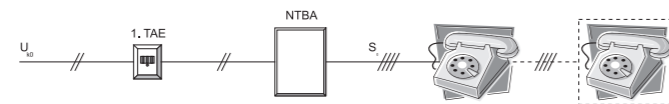

Digital signalling enables more intensive use of larger volumes of data and higher demands to be placed on communications.

The desire to communicate via several lines calls for the installation of a digital system. Such systems make use of special modems as well as ISDN telephones. This considerably increases the risk of transient interference such as surges.

The TAE surge protection for ISDN lines can be installed to protect against these surges.

The basic version of the surface-mounted TAE-NFN socket has two-stage surge protection provided by a gas discharge tube and fast-acting suppression diodes.

The gas discharge tube achieves a high energy discharge; the suppression diodes ensure a low residual voltage. This setup protects the end terminals.

Other TAE surge protection sockets with monitoring functions are also available.

These monitor the connection of the voice voltage/operating voltage. As soon as this is interrupted or short-circuited, the output is switched to high resistance. This signal can be evaluated via a PLC input. A visual indication (green LED) instead of the remote signalling can be selected as an option.

### Drawing with dimensions:

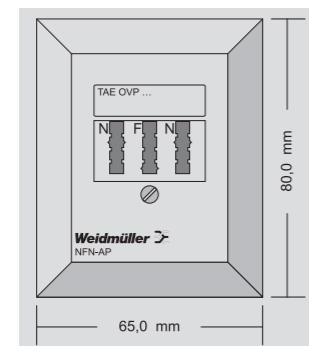

**For telecommunication interface**

- Surge protection for telecommunication interfaces
- High energy discharge with gas discharge tube
- Low residual voltage thanks to special suppressor diodes
- Surge protection for analogue telephone connections
- Including TAE-NFN wall-mounted socket

**TAE OVP**

TAE OVP analog

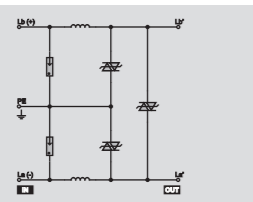

**TAE OVP**

TAE OVP analog LED

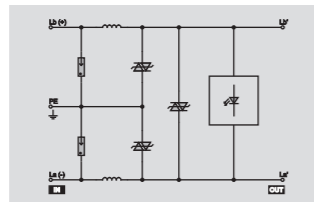

**TAE OVP**

TAE OVP analog FM

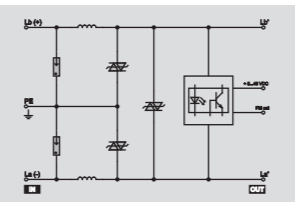

Surge protection for data interfaces

**Technical data**

**Technical data**

- Rated voltage (AC)
- max. continuous voltage, U<sub>c</sub> (AC)
- Operating current, I<sub>max</sub>
- Discharge current, max. (8/20 μs)
- Response time
- Protection level on output side sym., input
- 8/20 μs, typ.
- Protection level on output side unsym., input
- 8/20 μs, typ.
- Optical function indicator
- Pollution severity
- Surge category
- Ambient temperature (operational)
- Storage temperature

**General data**

- Input voltage, max.
- Standard signal
- Rated discharge current (8/20 μs)
- Total current
- Response time, typical
- Resistance per path
- Cut-off frequency f<sub>g,600 Ω</sub> system
- Transistor output, positive-switching
- Residual voltage at output for input pulse of 1 kV/μs
- Residual voltage at output for 8/20μs and input pulse of 5kA

Rated voltage (AC)	190 V
max. continuous voltage, U <sub>c</sub> (AC)	190 V
Operating current, I <sub>max</sub>	0.5 A
Discharge current, max. (8/20 μs)	10 kA
Response time	≤ 5 ns
Protection level on output side sym., input 8/20 μs, typ.	100 V @5kA
Protection level on output side unsym., input 8/20 μs, typ.	100 V @5kA
Optical function indicator	
Pollution severity	2
Surge category	III
Ambient temperature (operational)	0 ... 60°C
Storage temperature	-25 ... 85°C

Input voltage, max.	190 V
Standard signal	Analogue telephone signal Uko
Rated discharge current (8/20 μs)	4 kA
Total current	10 kA (8/20μs)
Response time, typical	< 5 ns
Resistance per path	1.1 Ω
Cut-off frequency f <sub>g,600 Ω</sub> system	2 MHz
Transistor output, positive-switching	
Residual voltage at output for input pulse of 1 kV/μs	a/b < 270 V, a-b/PE < 270V
Residual voltage at output for 8/20μs and input pulse of 5kA	a-b/PE < 100 V, a-b/PE < 100V

Rated voltage (AC)	190 V
max. continuous voltage, U <sub>c</sub> (AC)	190 V
Operating current, I <sub>max</sub>	0.5 A
Discharge current, max. (8/20 μs)	10 kA
Response time	≤ 5 ns
Protection level on output side sym., input 8/20 μs, typ.	100 V @5kA
Protection level on output side unsym., input 8/20 μs, typ.	100 V @5kA
Optical function indicator	LED
Pollution severity	2
Surge category	III
Ambient temperature (operational)	0 ... 60°C
Storage temperature	-25 ... 85°C

Input voltage, max.	190 V
Standard signal	Analogue telephone signal Uko
Rated discharge current (8/20 μs)	4 kA
Total current	10 kA (8/20μs)
Response time, typical	< 5 ns
Resistance per path	1.1 Ω
Cut-off frequency f <sub>g,600 Ω</sub> system	2 MHz
Transistor output, positive-switching	
Residual voltage at output for input pulse of 1 kV/μs	a/b < 270 V, a-b/PE < 270V
Residual voltage at output for 8/20μs and input pulse of 5kA	a-b/PE < 100 V, a-b/PE < 100V

Rated voltage (AC)	190 V
max. continuous voltage, U <sub>c</sub> (AC)	190 V
Operating current, I <sub>max</sub>	0.5 A
Discharge current, max. (8/20 μs)	10 kA
Response time	≤ 5 ns
Protection level on output side sym., input 8/20 μs, typ.	100 V @5kA
Protection level on output side unsym., input 8/20 μs, typ.	100 V @5kA
Optical function indicator	
Pollution severity	2
Surge category	III
Ambient temperature (operational)	0 ... 60°C
Storage temperature	-25 ... 85°C

Input voltage, max.	190 V
Standard signal	Analogue telephone signal Uko
Rated discharge current (8/20 μs)	4 kA
Total current	10 kA (8/20μs)
Response time, typical	< 5 ns
Resistance per path	1.1 Ω
Cut-off frequency f <sub>g,600 Ω</sub> system	2 MHz
Transistor output, positive-switching	5...48V DC / 0,1 A
Residual voltage at output for input pulse of 1 kV/μs	a/b < 270 V, a-b/PE < 270V
Residual voltage at output for 8/20μs and input pulse of 5kA	a-b/PE < 100 V, a-b/PE < 100V

E



**Dimensions**

- Clamping range (rating- / min. / max.) mm<sup>2</sup>
- Length x width x height mm

**Note**

**Clamp. yoke connection**

- 0.8 / 0.5 / 1.5
- 30 x 65 x 80

**Clamp. yoke connection**

- 0.8 / 0.5 / 1.5
- 30 x 65 x 80

**Clamp. yoke connection**

- 0.8 / 0.5 / 1.5
- 30 x 65 x 80

**Ordering data**

Version	Type	(Qty.=1)	Order No.
	TAE OVP analog		8673980000
	TAE OVP analog LED		8674020000
	TAE OVP analog FM		8649910000

**Note**

**Accessories**

**Note**



**Surge protection for telecommunication interfaces**

**For telecommunication interface**

- High energy discharge thanks to gas charge eliminator
- Low residual voltage thanks to special suppressor diodes
- Surge protection for ISDN, including TAE-NFN wall-mounted socket

**TAE OVP**

**TAE OVP ISDN**



**TAE OVP**

**TAE OVP ISDN LED**



**TAE OVP**

**TAE OVP ISDN FM**

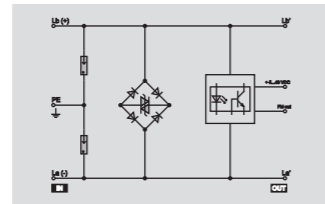
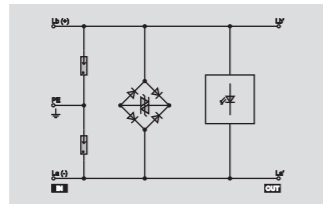
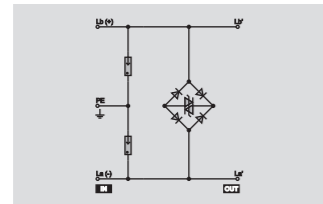
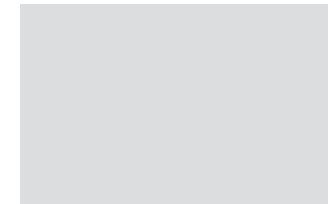

**Technical data**

**Technical data**

Rated voltage (AC)	190 V
max. continuous voltage, U <sub>c</sub> (AC)	190 V
Operating current, I <sub>max</sub>	0.5 A
Discharge current, max. (8/20 μs)	10 kA
Response time	≤ 5 ns
Protection level on output side sym., input 8/20 μs, typ.	100 V @5kA
Protection level on output side unsym., input 8/20 μs, typ.	100 V @5kA
Optical function indicator	
Pollution severity	2
Surge category	III
Ambient temperature (operational)	0 ... 60°C
Storage temperature	-25 ... 85°C

**General data**

Input voltage, max.	190 V
Standard signal	ISDN telephone signal Uko interface
Rated discharge current (8/20 μs)	4 kA
Total current	10 kA (8/20μs)
Response time, typical	< 5 ns
Resistance per path	1.1 Ω
Cut-off frequency 1g,600 Ω system	80 MHz
Transistor output, positive-switching	
Residual voltage at output for input pulse of 1 kV/μs	a/b < 270 V, a-b/PE < 270V
Residual voltage at output for 8/20μs and input pulse of 5kA	a-b/PE < 100 V, a-b/PE < 100V

**Dimensions**

Clamping range (rating- / min. / max.)	mm <sup>2</sup> 0.8 / 0.5 / 1.5
Length x width x height	mm 30 x 65 x 80

**Note**

**Clamp. yoke connection**

Clamping range (rating- / min. / max.)	mm <sup>2</sup> 0.8 / 0.5 / 1.5
Length x width x height	mm 30 x 65 x 80

AP enclosure NFN

**Ordering data**

Version	Type	(Qty.=1)	Order No.
	TAE OVP ISDN		8674000000

**Note**

**Accessories**

**Note**

**Technical data**

Rated voltage (AC)	190 V
max. continuous voltage, U <sub>c</sub> (AC)	190 V
Operating current, I <sub>max</sub>	0.5 A
Discharge current, max. (8/20 μs)	10 kA
Response time	≤ 5 ns
Protection level on output side sym., input 8/20 μs, typ.	100 V @5kA
Protection level on output side unsym., input 8/20 μs, typ.	100 V @5kA
Optical function indicator	green LED
Pollution severity	2
Surge category	III
Ambient temperature (operational)	0 ... 60°C
Storage temperature	-25 ... 85°C

**General data**

Input voltage, max.	190 V
Standard signal	ISDN telephone signal Uko interface
Rated discharge current (8/20 μs)	4 kA
Total current	10 kA (8/20μs)
Response time, typical	< 5 ns
Resistance per path	1.1 Ω
Cut-off frequency 1g,600 Ω system	2 MHz
Transistor output, positive-switching	
Residual voltage at output for input pulse of 1 kV/μs	a/b < 270 V, a-b/PE < 270V
Residual voltage at output for 8/20μs and input pulse of 5kA	a-b/PE < 100 V, a-b/PE < 100V

**Clamp. yoke connection**

Clamping range (rating- / min. / max.)	mm <sup>2</sup> 0.8 / 0.5 / 1.5
Length x width x height	mm 30 x 65 x 80

AP enclosure NFN

**Technical data**

Rated voltage (AC)	190 V
max. continuous voltage, U <sub>c</sub> (AC)	190 V
Operating current, I <sub>max</sub>	0.5 A
Discharge current, max. (8/20 μs)	10 kA
Response time	≤ 5 ns
Protection level on output side sym., input 8/20 μs, typ.	100 V @5kA
Protection level on output side unsym., input 8/20 μs, typ.	100 V @5kA
Optical function indicator	
Pollution severity	2
Surge category	III
Ambient temperature (operational)	0 ... 60°C
Storage temperature	-25 ... 85°C

**General data**

Input voltage, max.	190 V
Standard signal	ISDN telephone signal Uko interface
Rated discharge current (8/20 μs)	4 kA
Total current	10 kA (8/20μs)
Response time, typical	< 5 ns
Resistance per path	1.1 Ω
Cut-off frequency 1g,600 Ω system	2 MHz
Transistor output, positive-switching	
Residual voltage at output for input pulse of 1 kV/μs	5...48 V DC / 0,1 A
Residual voltage at output for 8/20μs and input pulse of 5kA	a/b < 270 V, a-b/PE < 270V
	a-b/PE < 100 V, a-b/PE < 100V

**Clamp. yoke connection**

Clamping range (rating- / min. / max.)	mm <sup>2</sup> 0.8 / 0.5 / 1.5
Length x width x height	mm 30 x 65 x 80

AP enclosure NFN

## Installation instructions for data interfaces

The supply and earth lines of the protective modules should be kept short in order to achieve optimum protection for the data terminals.

Likewise, the transmission paths should also be kept as short as possible because the longer the line, the greater is the chance of interference having an effect.

Inserting surge protection increases the attenuation of the line and so changes the signal-to-noise ratio.

### Installation position

Protective modules are frequently installed at both ends of the line.

It is important to ensure that protected and unprotected lines are routed separately. Further, there should be some clearance between power lines and data lines. A common cable duct must be subdivided with metal partitions.



### Shielded lines for data interfaces

Systems involving several buildings should be designed with cable shielding capable of carrying current. These data lines often have two shields: one for carrying transient currents, the other as protection against coupled interference.

### Circuit concepts

High transmission frequencies place greater demands on surge protection in protective circuits for data interfaces. Gas discharge tubes are frequently the sole means of protection here. But the disadvantage of this is that the protection level is very high. Lower protection levels can be attained at high transmission frequencies by using special low-capacity suppressor diodes.

# Applications for data surge protection / LON™ termination

The surge protection technology from Weidmüller can also be used effectively in building services and industrial automation. The universal **automation network LON** is commonly used these days worldwide.

**LON** is the abbreviation for “**Local Operating Network**” and is also known as **LONWORKS®**. It was developed by the Echelon Corporation of Palo Alto, USA. Some 10,000 sensors and actuators can be linked to form an integrated building services automation network by means of a **LON network**.

The network topology and cabling of **LON networks** does not need to follow any particular structure. Star-type, ring, tree or classic series structures can be chosen as required. In practice this often results in free topologies based on existing structures in buildings or plants. A twisted 2-wire **LON LPT/FTT/TP78** line is often used.

The **MCZ OVP LON** is used as surge protection for lines between different buildings. The **MCZ OVP LON** is a terminal that is installed at the points on the circuit diagrams marked with a “T”.

The **MCZ OVP** surge protection for the **LON system** is installed at the building boundary in the first switching cabinet. It is also advisable to incorporate a shielded line for these routes. This may then be held by a Weidmüller terminal clamp (KLBÜ).

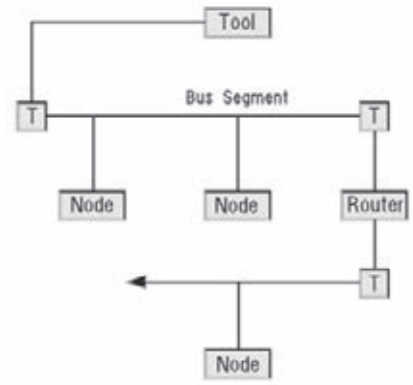

TP / XF Multidrop Bus Topology (J3)

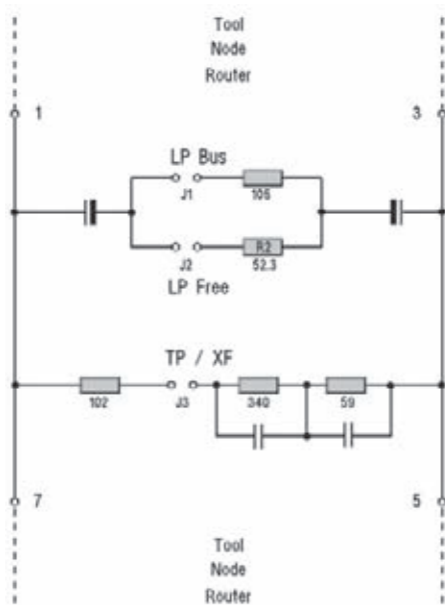

Circuit diagram of termination

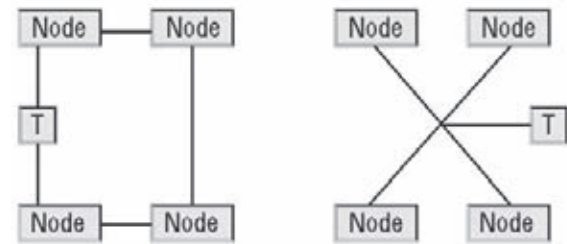

FT / LP Free Topology (J2)

# Applications for data surge protection / RS485 for 2- or 4-wire



Data from a well plant is to be transmitted via a Profibus data line (RS 485 signal) to a control room. With distances of up to 80 m it is advisable – in exposed locations – to install surge protection both before the well plant and before the Profibus module in the control room. The robust design in the K21 housing means that this surge protection can be installed directly in situ. The RS 485 bus can be designed as a 2- or 4-wire system. A 4-wire application is shown here, with direct earthing for one station. In this case there is a connection between GND and earth. The other side, approx. 80 m distant, has a high-resistance earth via the integral gas discharge tube. For further information, see the internal circuit diagram of the surge protection.

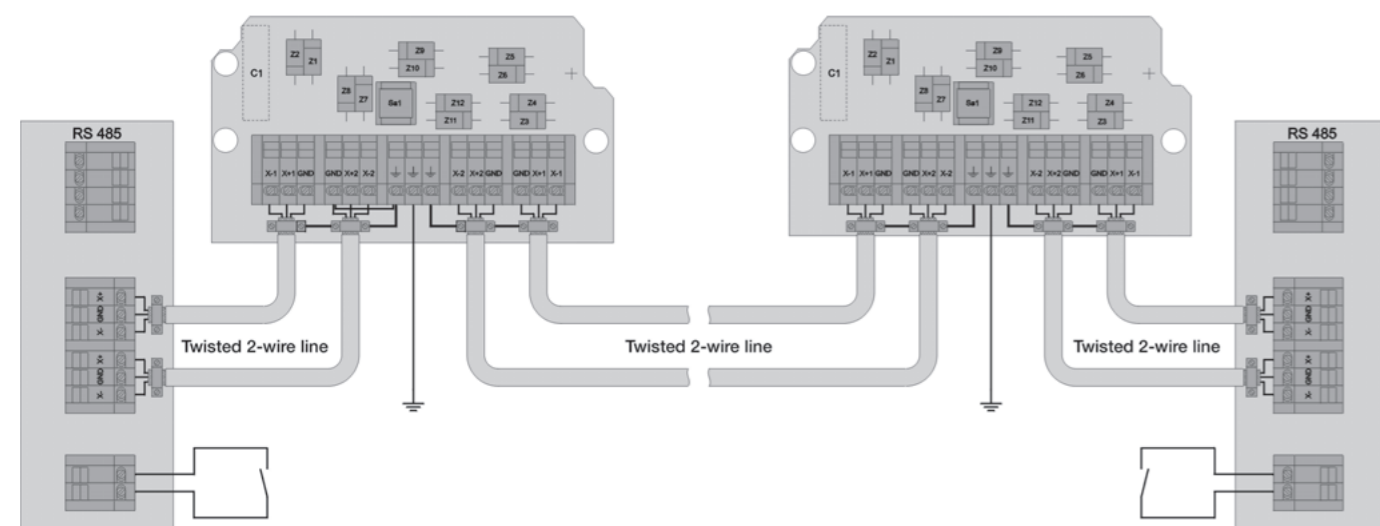
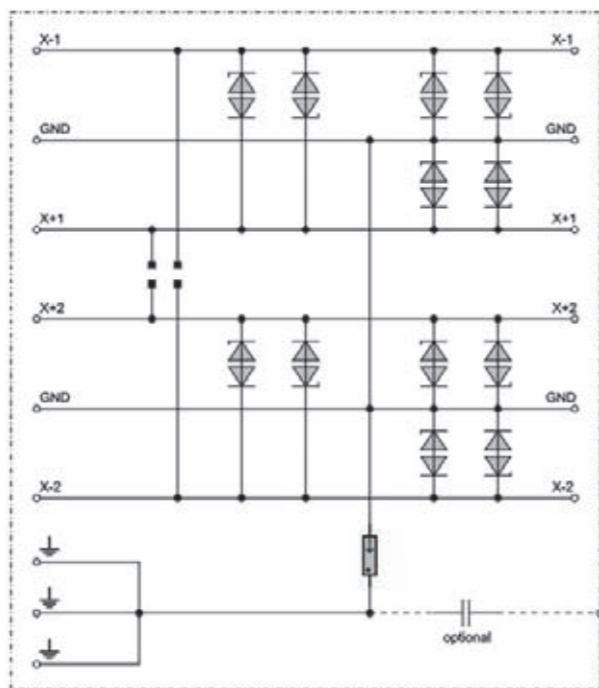

# Applications for data surge protection / RS485 for T-junction



Data is to be transmitted via a Profibus data line (RS 485 signal). This data is sent to several Profibus systems. In this case it is advisable to split up the signal via a T-junction. The signal is looped through the surge protection and also branched. To do this, the two soldered connections on the PCB must be bridged. The robust design in the K21 housing means that this surge protection can be installed directly in situ.

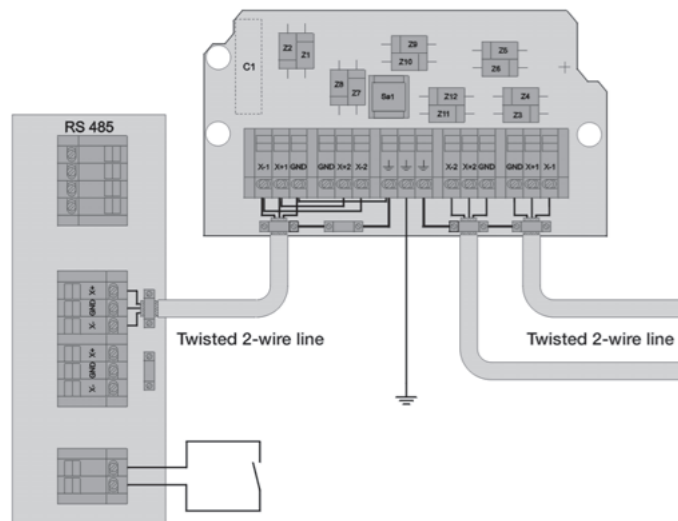
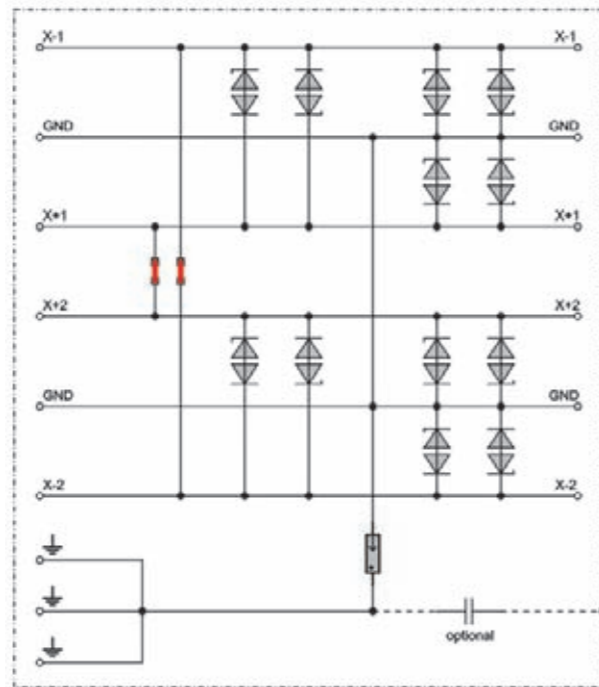

# LON™ application

A residential development with 70 housing units is to be networked for control purposes with a LON™ system. In practice free topologies often arise based on existing structures in buildings or plants. The twisted 2-wire LON TP78 line is to be used. An automatic control system will be installed in each building.

A co-generation power station receives requests for heating and hot water requirements via the LON™ network. In total, the transmission path exceeds 3000 m. The MCZ ovp surge protection for the LON™ system is installed at the building boundary, i.e. in the first distribution board for each building. In addition, the system is adapted to suit with the LON termination.

It is also advisable to incorporate a shielded line for these paths. This line is then held by a Weidmüller terminal clamp (KLBÜ).

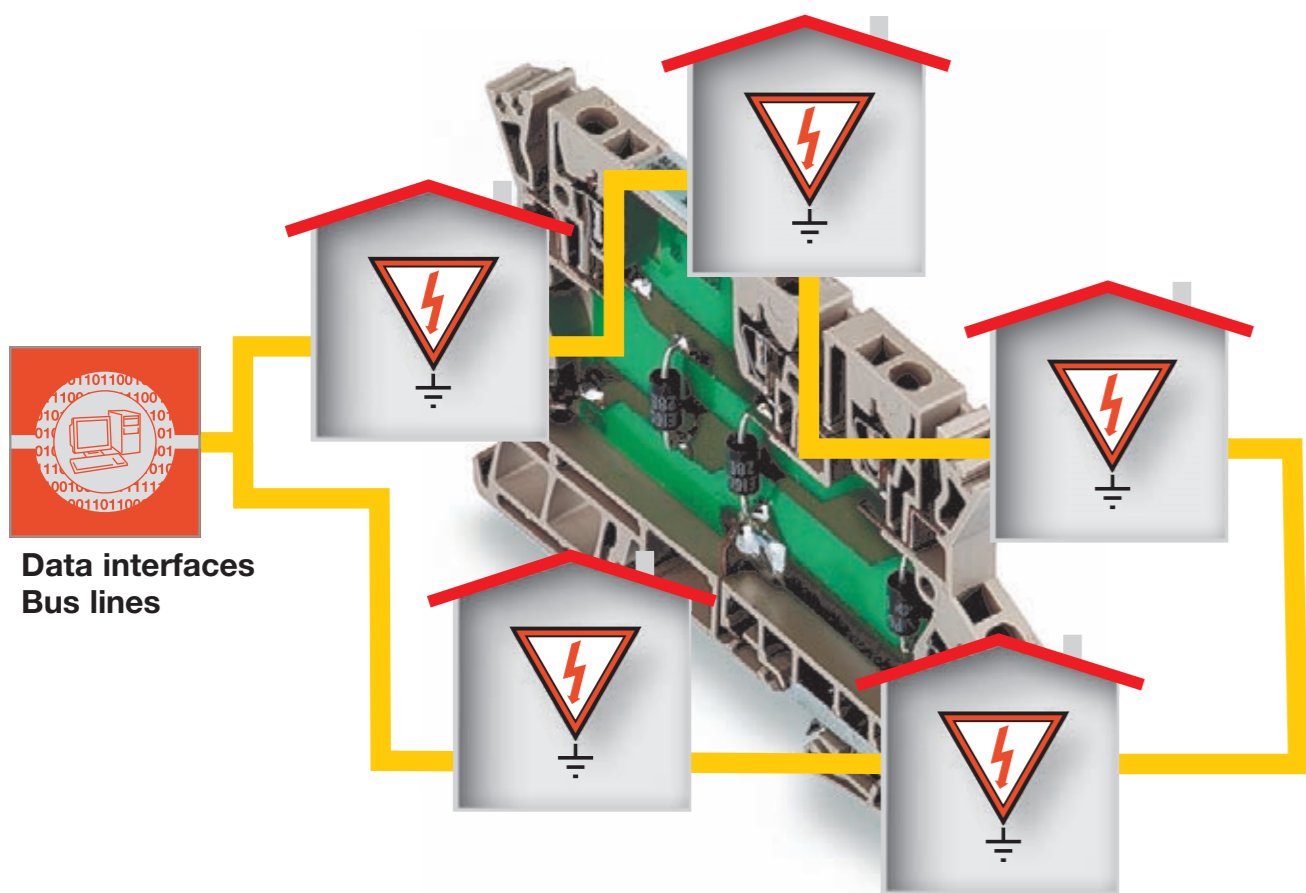





# Surge protection for photovoltaic systems

<b>Surge protection for photovoltaic systems</b>	Photovoltaic application example	F.2
	Photovoltaic surge protection	F.10



## Protect your installation from voltage surges!

Photovoltaic (PV) facilities for exploiting renewable energy are at great risk from lightning discharges because of their exposed location and large surface area.

Damage to individual segments or the failure of the entire installation can be the consequence.

To protect all downstream devices, the feeding power lines must be fitted with overvoltage protection. Therefore, a photovoltaic installation should, whatever the case, also be integrated into the existing lightning protection and earthing concept.

As a result of decades of experience in the development and production of electrical connection systems, we have become experts in customised solutions for building installations.

F



That's why you should safeguard your photovoltaic installation with lightning and overvoltage protection from Weidmüller:

- to protect your building and PV installation
- to increase system availability
- to safeguard your investment



## Surge protection means damage prevention



F



Lightning strikes and voltage surges are frequently the cause of damage to inverters and PV modules. Any operator of a PV installation knows that such damage is often associated with further costs: they are not only burdened with high repair costs, the efficiency of their system can be seriously impaired.

To avoid such failures, it is essential to use lightning and over-voltage protection concepts that are designed to work optimally together. We can help you with this: to ensure that your installation works trouble-free and that you actually achieve the revenue you forecast!

### Standards and requirements

The current standards and directives for overvoltage protection must always be taken into account in the design and installation of any photovoltaic system.

The European draft standard DIN VDE 0100 part 712/E DIN IEC 64/1123/CD (construction of low-voltage systems; requirements for special installations and rooms; photovoltaic supply systems) describes how to select and construct the overvoltage protection system for the PV installation.

In its publication 2010 for buildings with a PV installation, the Association of German Property Insurers (VdS) requires > 10 kW lightning and overvoltage protection in accordance with lightning protection class III.

To ensure that your installation is future-safe, it goes without saying that our components satisfy the requirements.



Module box after lightning strike



# Optimally protected, with surge protection from Weidmüller

Our surge protection modules in Class I and Class II (B and C arresters) ensure voltage occurrences are quickly limited and that the current is safely discharged. This allows you to avoid expensive damages or even complete outages in your photovoltaic facility.

For buildings with or without lightning protection systems – we have the right product for every application! We can deliver the modules as you require – fully customized and pre-wired into housing.

## Deploying surge protection devices (SPDs) in photovoltaic systems

There are a number of special characteristics to be considered when deploying surge protection devices (SPDs) in photovoltaic systems. In contrast to utilizing SPDs in AC voltage circuits, photovoltaic systems represent a DC voltage source with specific characteristics. The system concept must take these specific characteristics into consideration and coordinate the use of SPDs accordingly. For instance SPD specifications for PV systems must be designed both for a maximum no-load voltage of the solar generator ( $V_{OC, STC}$  = voltage of the unloaded circuit under standard test conditions) as well as with regard to ensuring maximum system availability and safety.

The photovoltaic (PV) is an elementary pillar of power generation in the field of renewable or rather regenerative energy. That does not just apply to Germany; Southern Europe and North America are equally important export markets. For the installation of photovoltaic systems the standard standard IEC 60364-7-712:2002 [1] has been applicable since June 2006. This is a harmonised European standard, which means it is a HD document. Its transitional period ended on 1st March 2008; as a consequence the standard is in force and must be applied. This standard contains information relating to overvoltage protective devices and lightning protection. It does not explicitly require surge voltage protection; however, it is recommended (Figure 1). Equally, the standard points out that when lightning protection is deployed the PV system must be protected by an isolated air-termination system – and the separation distance must be maintained.

## External lightning protection

Owing to their large surface expansion and generally exposed installation location photovoltaic systems are particularly risk from atmospheric discharges – such as lightning. At this point there is a need to differentiate between the effects of direct lightning strikes and so-called indirect (inductive and capacitive) strikes. On the one hand the necessity for lightning protection depends on the normative specifications of the relevant standards and on the application itself on the other; in other words, depending on if it is a building or field installation. With building installations a difference is drawn between the installation of a PV generator on the roof of a public building – with an existing lightning protection system – and the installation on the roof of a barn – without a lightning protection system. Field installations also offer large potential targets due to their large area module arrays; in this case, an external lightning protection solution is recommendable for this type of system to prevent direct lightning strikes.

Normative information is contained in the DIN EN 62305-3 (VDE 0185-305-3) Supplement 2 (design specifications according to protection class and hazard level LPL III) [2] and VdS guidelines 2010 [3] (lightning protection is required in PV systems > 10kW). In addition, surge protection measures are required. For instance, preference should be afforded to separate air-termination systems to protect the PV generator. However, if it is not possible to avoid a direct connection to the PV generator, in other words the safety separation distance cannot be maintained, then the effects of partial lightning currents must be taken into consideration. Fundamentally, shielded cables should be used for the main lines of generators to keep induced overvoltages as low as possible. In addition, if the cross-section is sufficient (min. 16mm<sup>2</sup> Cu) the cable shielding can be utilized to conduct partial lightning currents. The same applies to the utilization of closed metal housings. Earthing must be connected at both ends of cables and metal housings. That ensures that the main lines of the generator fall under LPZ1 (Lightning Protection Zone); that means that a SPD type 2 suffices. Otherwise, an SPD type 1 would be required.

## Utilization and correct specification of surge protection devices

In general, it is possible to consider the deployment and specification of SPDs in low voltage systems on the AC side as standard procedure; however, the deployment and the correct design specification for PV DC generators still remains a challenge. The

reason is firstly a solar generator has its own special characteristics and, secondly, SPDs are deployed in the DC circuit. Conventional SPDs are typically developed for alternating voltage and not direct voltage systems. Relevant product standards [4] have covered these applications for years, and these can fundamentally also be applied to DC voltage applications. However, whereas previously relatively low PV system voltages were realised, today these are already achieving approx. 1000V DC in the unloaded PV circuit. The task is indeed to master system voltages of that order with suitable surge protection devices.

At which positions it is technically appropriate and practical to position SPDs in a PV system depends primarily on the type of system, the system concept and the physical surface area. Figure 2 and 3 illustrate the principle difference: Firstly, a building with external lightning protection and a PV system mounted on the roof (building installation); secondly, an expansive solar energy system (field installation), also fitted with an external lightning protection system. In the first instance – because of the shorter cable lengths – protection is merely implemented at the DC input of the inverter; in the second case SPDs are installed in terminal box of the solar generator (to protect the solar modules) as well as at the DC input of the inverter (to protect the inverter). SPDs should be installed close to the PV generator as well as close to the inverter as soon as the length of cable required between the PV generator and the inverter extends beyond 10 meters (Figure 2). The standard solution to protect the AC side, meaning the inverter output and network supply, must then be achieved by utilizing SPDs type 2 installed at the inverter output and – in the case of a building installation with external lightning protection at the mains feed-in point – equipped with an SPD type 1 surge arrester.

**Special characteristics on the DC solar generator side**

Until now protection concepts for the DC side always used SPDs for normal AC mains voltages, whereby L+ and L- respectively were wired to earth for protection. Thereby, the SPDs were rated for at least 50 percent of the maximum solar generator no-load voltage. After a number of years insulation faults can occur in the PV generator. As a consequence of this fault in the PV system the full PV generator voltage is then applied to the non-faulty pole in the SPD and results in an overload event. If the load on SPDs based on metal-oxide varistors from a continuous voltage is too high this can possibly result in their destruction or trigger the disconnecting device. In particular in PV systems with high system voltages it is not possible to completely exclude the possibility of

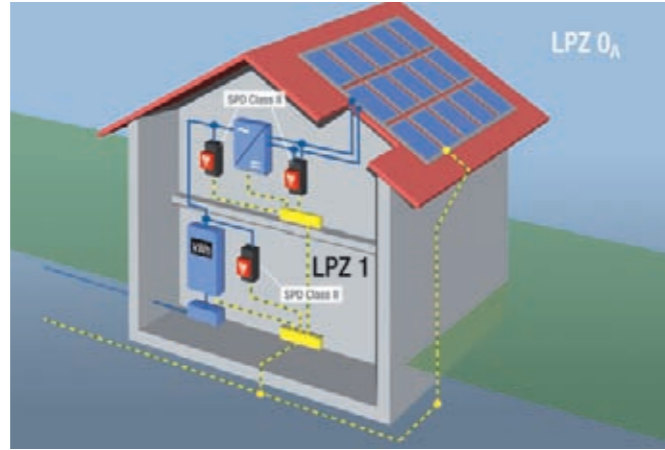

Figure 1: Schematic diagram from standard IEC 60364-7-712:2002

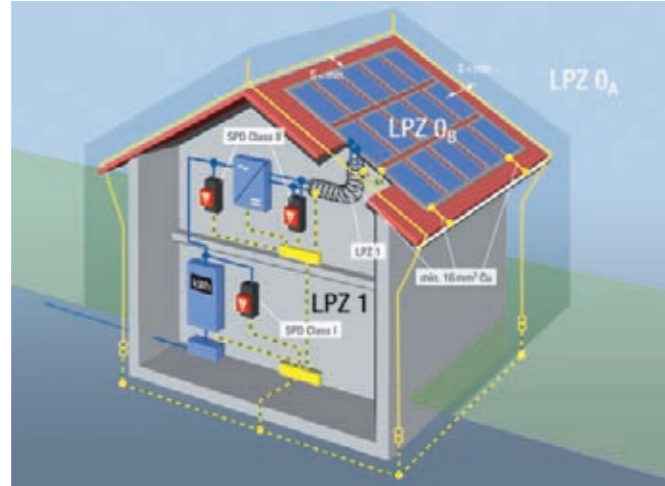

Figure 2: Building installation with external lightning protection system, in compliance with air termination distances

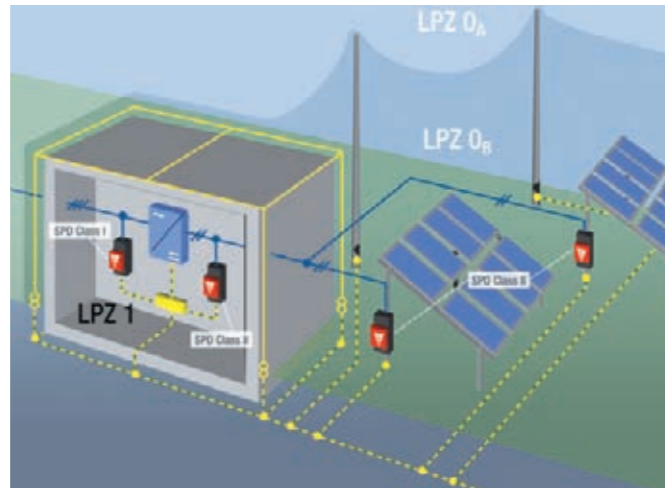

Figure 3: Field installation with external lightning protection system

F



## Photovoltaic application example

a fire developing under unfavourable circumstances caused by a non-extinguished switching arc when the disconnection device is triggered. Even upstream overload protection elements (fuses) are not a solution to this probability, as the short-circuit current of the PV generator is only slightly higher than that of the rated current. Today, PV systems with system voltages of approx. 1000V DC are increasingly being installed to keep power losses as low as possible. To ensure that SPDs can master such high system voltages the star connection consisting of three varistors has proven reliable and has become established as a quasi standard (Figure 4). If an insulation fault occurs two varistors in series still remain, which effectively prevents the SPD from being overloaded. Nonetheless, it is also the case here that so-called leakage currents flow in the varistor itself. The likelihood of higher leakage currents increases as the varistor ages and frequent overvoltage loads. In unfavourable circumstances higher leakage currents can in turn (as described above) result in a fire developing due to the insufficient DC switching capacity of the disconnecting device.

That means there are two different aspects to be considered – a too high continuous voltage applied to the SPD caused by a fault in the PV system and the flow of a high leakage current, for example due to frequent overvoltage loads. A solution is offered by a star connection (Figure 5) consisting of two varistors and a spark gap to the earth potential. The star connection prevents a too-high continuous current being applied to the SPD in the event of an insulation fault in the PV circuit; the spark gap itself prevents a leakage current. In other words: The spark gap prevents the suppressor circuit from being activated should an insulation fault occur. In reality, the connection in series of a metal-oxide varistor and a spark gap (here a gas discharge tube) is nothing new; it offers a reminder of the days of the old valve-type arresters. Utilization in a DC circuit is the only difference. To effectively extinguish the gas discharge tube the voltage applied must be less than the minimum arc voltage.

In conclusion it is possible to say: with a star connection composed of two varistors and a spark gap it is possible to achieve a suppressor circuit that is absolutely free of leakage-currents and prevent undesired actuation of the disconnecting device. This in turn effectively prevents the scenario described above of a fire developing. And at the same time any influencing of an insulation monitoring device is also prevented. That facilitates a completely unearthed, floating construction – even in conjunction with very high DC voltages.

In this instance Weidmüller offers a sophisticated, applications oriented solution with its SPD type 2 surge arrester PU II 2+1 550 V up to VOC STC < 1000 V DC. (Figure 5).

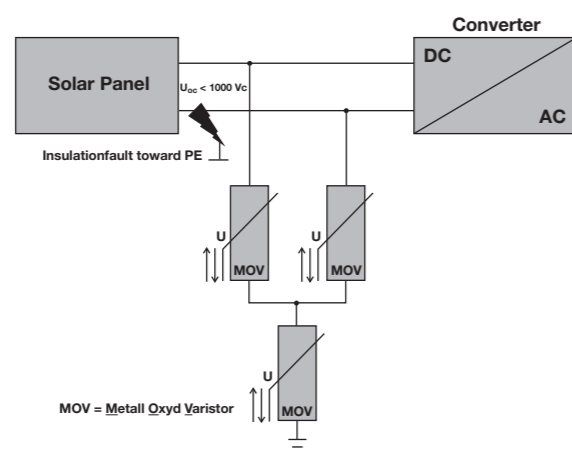

Figure 4: Y-shaped protective circuitry with three varistors

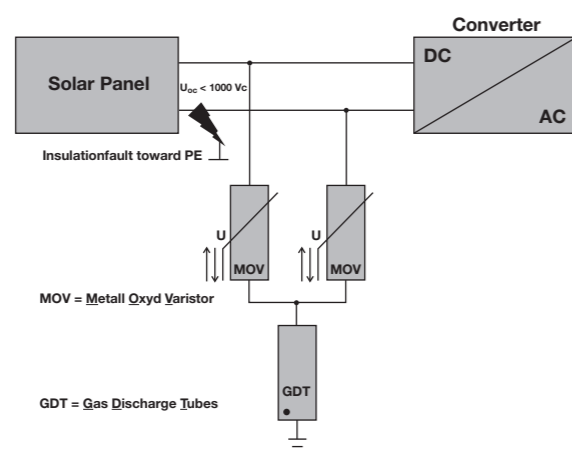

Figure 5: Y-shaped protective circuitry with two varistors and a spark gap



Figure 6: Building installation with external lightning protection, not in compliance with air termination distances

**Practical applications**

As already noted, a difference is drawn between building and field installations in practical solutions. If an external lightning protection solution is fitted, the PV generator should preferably be integrated into this system as an isolated arrester device system. IEC 62305-3 specifies that the air termination distance must be maintained. If it cannot be maintained then the effects of partial lightning currents must be taken into consideration. On this point the standard for protection against lightning IEC 62305-3 Supplement 2 states in Section 17.3: 'to reduce induced overvoltages shielded cables should be used for the main lines of the generator'. If the cross-section is sufficient (min. 16 mm<sup>2</sup> Cu) the cable shielding can also be used to conduct partial lightning currents. Supplement (Figure 5) - Protection against lightning for photovoltaic systems – issued by the ABB (Committee for Lightning Protection and Lightning Research of the (German) Association for Electrical, Electronic and Information Technologies) states that the main lines for the generators should be shielded. That means that lightning current arresters (SPD type 1) are not required, notwithstanding, however, surge voltage arresters (SPD type 2) are necessary on both sides. As Figure 6 illustrates a shielded main generator line offers a practical solution and achieves LPZ 1 status in the process. In this manner, SPD type 2 surge arresters are deployed in compliance with standards specifications.

**Ready-to-fit solutions**

To ensure on-site installation is as straightforward as possible Weidmüller offers ready-to-fit solutions to protect the DC and AC sides of inverters. Plug and Play boxes with type 2 surge arresters both for DC and for the combination with the AC side reduce installation times; they are designed to offer IP 65 rated protection and equipped with MC4 connections. Weidmüller offers PV boxes for one or two solar strings as well as the combination with the AC side and a disconnecting device on the DC side in compliance with DIN VDE 0100 (VDE 0100) Part 712 (Figure 6). Weidmüller also supplies customised assemblies on request.

The products described below protect your photovoltaic installation, secure your investment and increase the availability of the installation.

**PU II 2+1 550 V / 40 kA**

- 470/690 V overvoltage arrester
- Suitable for PV-voltage of up to 1,000 V
- High energy absorption with  $I_{\max}$ : 40 kA per disc

**PU II 4 280 V / 40 kA**

- 230/400 V overvoltage arrester
- Suitable for the TN CS power system
- High energy absorption with  $I_{\max}$ : 40 kA per disc

F

**PU BC**

- 230/400 V combined lightning and voltage surge arrester
- Single-pole version with  $I_{\text{imp}}$ : 16 kA
- High energy absorption with  $I_{\max}$ : 60 kA per PU BC
- Option of V-form connection of conductors

**PV-Box AC/DC**

- Plug and Play - all connections are hard-wired internally
- MC4 connections, other connections are also possible
- PU II surge arrester especially for PV systems
- Customer-specific assemblies are available.



## Photovoltaic application example

Our products offer you the following advantages:

- Plug-in varistor top sections are easy to replace
- Protection is quickly available, that means longer service life of the protected installation
- Low residual voltage and consequently safety of the installation
- Thermal and dynamic protection of arresters with mains disconnection in the event of fault
- Coded voltage level prevents plugging in of incorrect module

### Note:

**Country-specific standards and guidelines must be observed**

## F



Literature

- [1] DIN VDE 0100(VDE 0100) part 712: 2006-06, Requirements for special installations or locations. Solar photovoltaic (PV) power supply systems
- [2] DIN EN 62305-3 (VDE 0185-305-3)2006-10 Protection against lightning, part 3: Protection for structures and persons
- [3] VdS Directive 2010:2005-07 Risk-oriented lightning and surge protection; Guidelines for loss prevention, VdS Schadenverhütung Verlag (publishers)
- [4] DIN EN 61643-11 (VDE 675-6-11): 2007-08 Low-voltage surge protective devices – Part 11: surge protective devices for use in low-voltage power systems – requirements and tests

## Modular use of our surge protection components

If a lightning protection system is already present on the building, this must be the highest point of the entire system. All modules and cables of the photovoltaic installation must be installed below the air terminations. Separation distances of at least 0.5 m to 1 m must be adhered to.

Also, the external lightning protection system requires the installation of a lightning arrester of class I in the incoming supply of the building. If no lightning protection system is present, the use of class II arresters is sufficient.

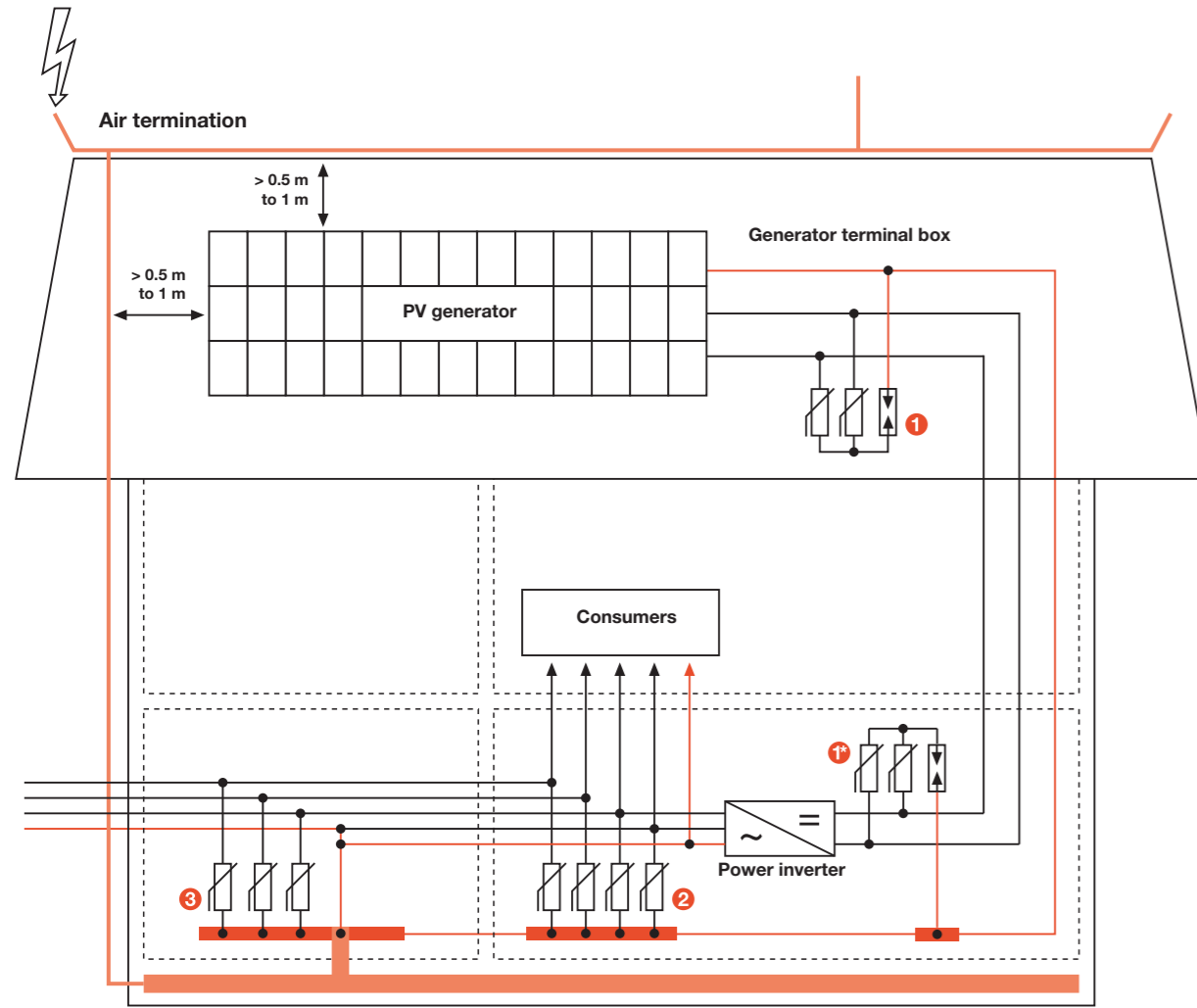

(example drawing: no liability taken)

You get from us safe surge protection for all components to be protected.

① PU II 2+1 550 V / 40 kA

Y-connection

② PU II 4 280 V / 40 kA

For a large distance between inverter and house incoming supply

⊕ PU II 2+1 550 V / 40 kA

For a large distance between PV generator and inverter

③ PU BC

In the event of an existing lightning protection system

F



**PV-Box DC**

**PV-Box DC 2**

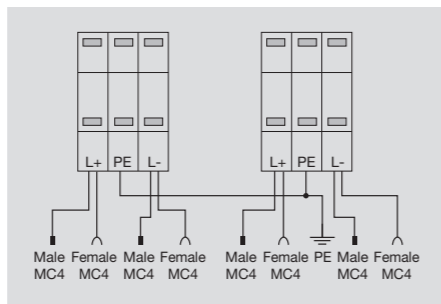
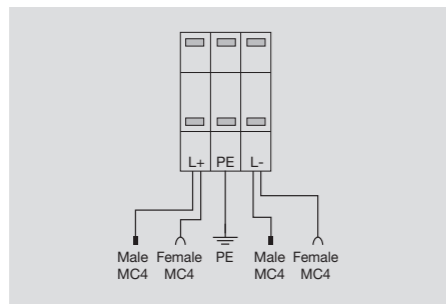

**Technical Data**

Suitably for DC Voltage ≤ 1,000 V  
 Number of strings to be protected  
 Number MC4 plugs male  
 Number MC4 plugs female  
 Number of PE-connection  
 Surge protection for AC  
 Direct connection via measurement disconnect terminal  
 DC-Main switch (50 A DC)  
 Housing

Suitably for DC Voltage ≤ 1,000 V	yes
Number of strings to be protected	1
Number MC4 plugs male	2
Number MC4 plugs female	2
Number of PE-connection	1
Surge protection for AC	no
Direct connection via measurement disconnect terminal	no
DC-Main switch (50 A DC)	no
Housing	IP65

Suitably for DC Voltage ≤ 1,000 V	yes
Number of strings to be protected	2
Number MC4 plugs male	4
Number MC4 plugs female	4
Number of PE-connection	1
Surge protection for AC	no
Direct connection via measurement disconnect terminal	no
DC-Main switch (50 A DC)	no
Housing	IP65

<b>Dimensions</b>	
Length x width x height	mm

190 x 185 x 106
-----------------

250 x 330 x 140
-----------------

<b>Note</b>
-------------

Suitable for the protection of the DC side of **one string**. The connection works via MC4 plugs with Uoc: < 1,000 V.

Suitable for the protection of the DC side of **two strings**. The connection works via MC4 plugs with Uoc: < 1,000 V.

**Ordering data**

<b>Version</b>
----------------

Type	Qty.	Order No.
PV-Box DC	1	8959710000

Type	Qty.	Order No.
PV-Box DC 2	1	8959720000

<b>Note</b>
-------------

**Accessories**

<b>Note</b>
-------------

--

--

PV-Box AC/DC

PV-Box AC/DC 2

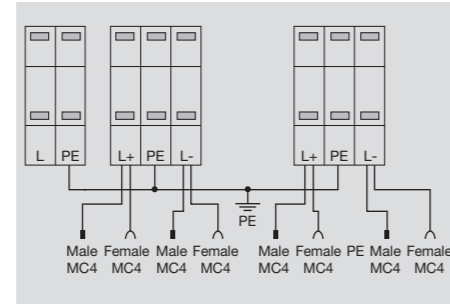
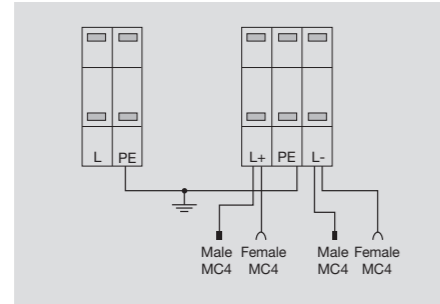

Technical Data

Suitably for DC Voltage ≤ 1,000 V  
 Number of strings to be protected  
 Number MC4 plugs male  
 Number MC4 plugs female  
 Number of PE-connection  
 Surge protection for AC  
 Direct connection via measurement disconnect terminal  
 DC-Main switch (50 A DC)  
 Housing

Suitably for DC Voltage ≤ 1,000 V	yes
Number of strings to be protected	1
Number MC4 plugs male	2
Number MC4 plugs female	2
Number of PE-connection	1
Surge protection for AC	yes
Direct connection via measurement disconnect terminal	no
DC-Main switch (50 A DC)	no
Housing	IP65

Suitably for DC Voltage ≤ 1,000 V	yes
Number of strings to be protected	2
Number MC4 plugs male	4
Number MC4 plugs female	4
Number of PE-connection	1
Surge protection for AC	yes
Direct connection via measurement disconnect terminal	no
DC-Main switch (50 A DC)	no
Housing	IP65



Dimensions	
Length x width x height	mm

185 x 185 x 110
-----------------

250 x 330 x 145
-----------------

Note
------

Suitable for the protection of the **DC side of one string**. The connection for DC works via MC4 plugs with U<sub>oc</sub>: < 1,000 V. The 230 V AC **are direct connected**.

Suitable for the protection of the **DC side of two strings**. The connection for DC works via MC4 plugs with U<sub>oc</sub>: < 1,000 V. The 230 V AC **are direct connected**.

Ordering data

Version	Type	Qty.	Order No.
	PV-Box AC/DC	1	8959730000

Version	Type	Qty.	Order No.
	PV-Box AC/DC 2	1	8959740000

Note
------

Accessories

Note
------

Photovoltaic surge protection

**PV-Box Multistring**

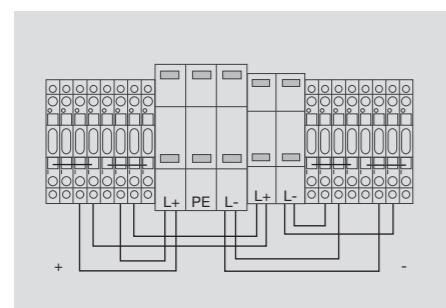

**F**



**Technical Data**

Technical Data	
Suitably for DC Voltage ≤ 1,000 V	no
Number of strings to be protected	8
Number MC4 plugs male	no
Number MC4 plugs female	no
Number of PE-connection	1
Surge protection for AC	no
Direct connection via measurement disconnect terminal	yes
DC-Main switch (50 A DC)	yes
Housing	IP65

Dimensions	
Length x width x height	mm 250 x 330 x 145

Note	
Suitable for <b>8 Strings</b> up to Uoc < 500 V via measurement disconnect terminals. All parts are wired with the surge protection device. The DC-main switch works up to 50 A. The external wiring goes directly in the measurement terminals.	

**Ordering data**

Version	Type	Qty.	Order No.
	PV-Box Multistring	1	<b>8959750000</b>

Note	

**Accessories**

Note	

# Things worth knowing about surge protection

<b>Things worth knowing about surge protection</b>	3+1 circuit: universal solution	G.2
	Country-specific standards and directives	G.4
	Standard texts for tenders	G.9
	Questions and answers concerning surge protection	G.10
	Glossary	G.13



**3+1 circuit: universal solution**

# Surge protection with 3+1 circuit in consumer installations with TT systems

3+1 does not always equal 4! At least not in the case of protective circuits with arresters in a TT system.

In a TT system the supply is via the three phase conductors L1, L2 and L3 and the neutral conductor N, i.e. without an additional integral PE conductor. The equipotential bonding is then made separately within the consumer installation through the earthing. The outcome of this is that the neutral conductor can accommodate a higher voltage compared to the earth potential. Therefore, to protect against overvoltages between neutral conductor and earth potential, an arrester must be incorporated here as well.

The "four-arrester circuit" does not satisfy all safety aspects. Up to now, four arresters, i.e. one each between earth potential and L1, L2, L3 and N, were installed in consumer installations with TT systems. However, this "four-arrester circuit" is no longer regarded as the optimum solution because the physical characteristics of the varistors used may lead to unacceptably high touch voltages at the PE conductor in the consumer installation. Depending on the age of the system, leakage currents can flow through varistors and cause overvoltages via the earthing resistance. The downstream residual-current circuit-breaker always included in TT systems cannot measure such leakage currents and therefore cannot be tripped.

Furthermore, a failed, i.e. low-resistance, varistor would create a connection between N and PE. One remedy is to install an arrester disconnecter in series with the varistors. But an arrester disconnecter that monitors the varistors takes up space and costs extra.

If instead of varistors, sparkover gaps were to be arranged between the conductors and the equipotential bonding, then that, too, would not be an ideal solution. The longer time to sparkover and the characteristics of the sparkover gaps result in higher residual voltages.

**TN-S system**

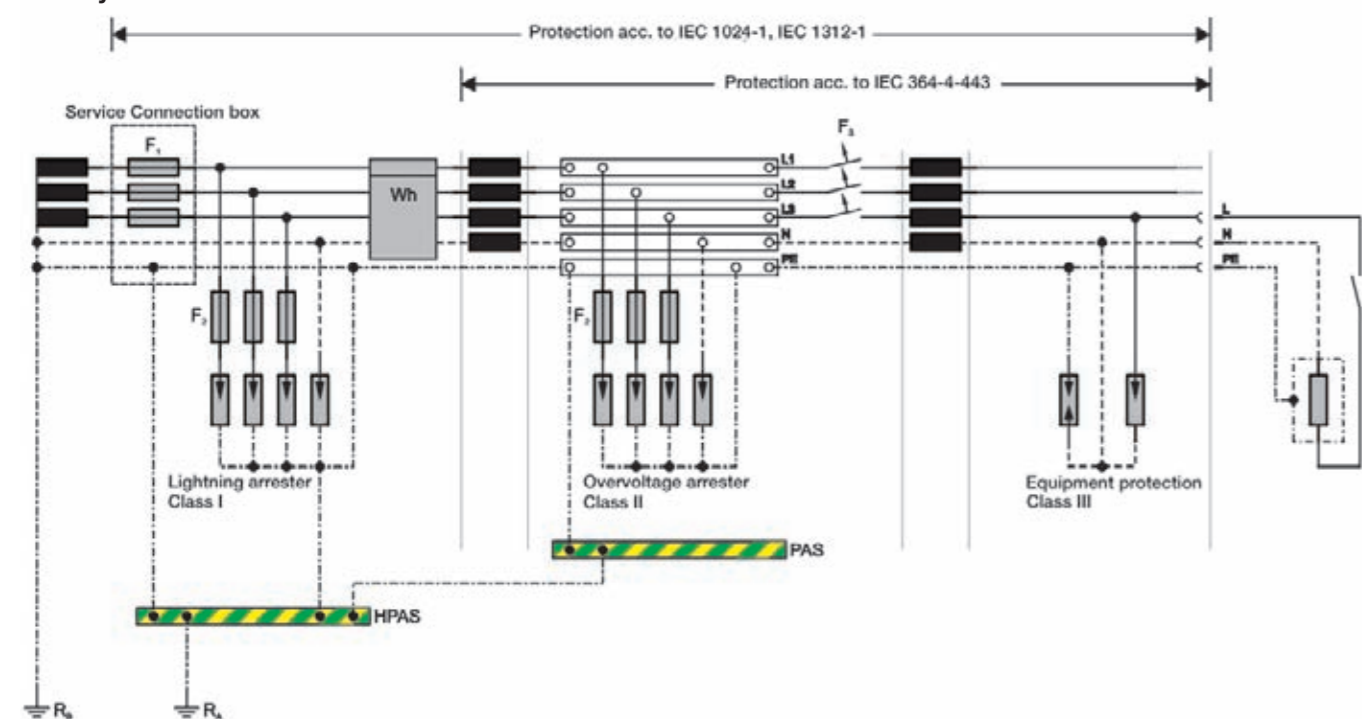



## 3+1 circuit provides better protection against hazardous touch voltages

The 3+1 circuit includes varistors on the three L conductors and the N conductor, and a sparkover gap between the base of the three varistors at the N conductor and the equipotential bonding rail (PE). The size of the sparkover gap must be such that it can accommodate the total current of the three phase conductors and the neutral conductor. The sparkover voltage of the sparkover gap in 230 V systems should be 1.5...2 kV.

Note: Although the "four-arrester circuit", i.e. with one varistor each between earth potential and L1, L2, L3 and N, is prescribed in VDE 0100 part 534 (section 524.2.1) for consumer installations in TN-S systems, the 3+1 circuit would also be possible here without increasing the risk. In ÖVE/ÖNORM E 8001-1/A2:2003-11-01, the 3+1 circuit is already expressly listed for use in TN-S and TT systems.

The sparkover gap isolates the three varistors electrically from the PE so that leakage currents through the varistors cannot cause voltage increases at the PE. The residual-current circuit-breaker behind the 3+1 circuit then provides reliable protection against hazardous touch voltages in all situations.

In terms of its relevance for safety aspects, the 3+1 circuit described in VDE 0100 part 534 (section 534.2.2) can therefore be regarded as a solution for surge protection in TT systems.

G



### TT system

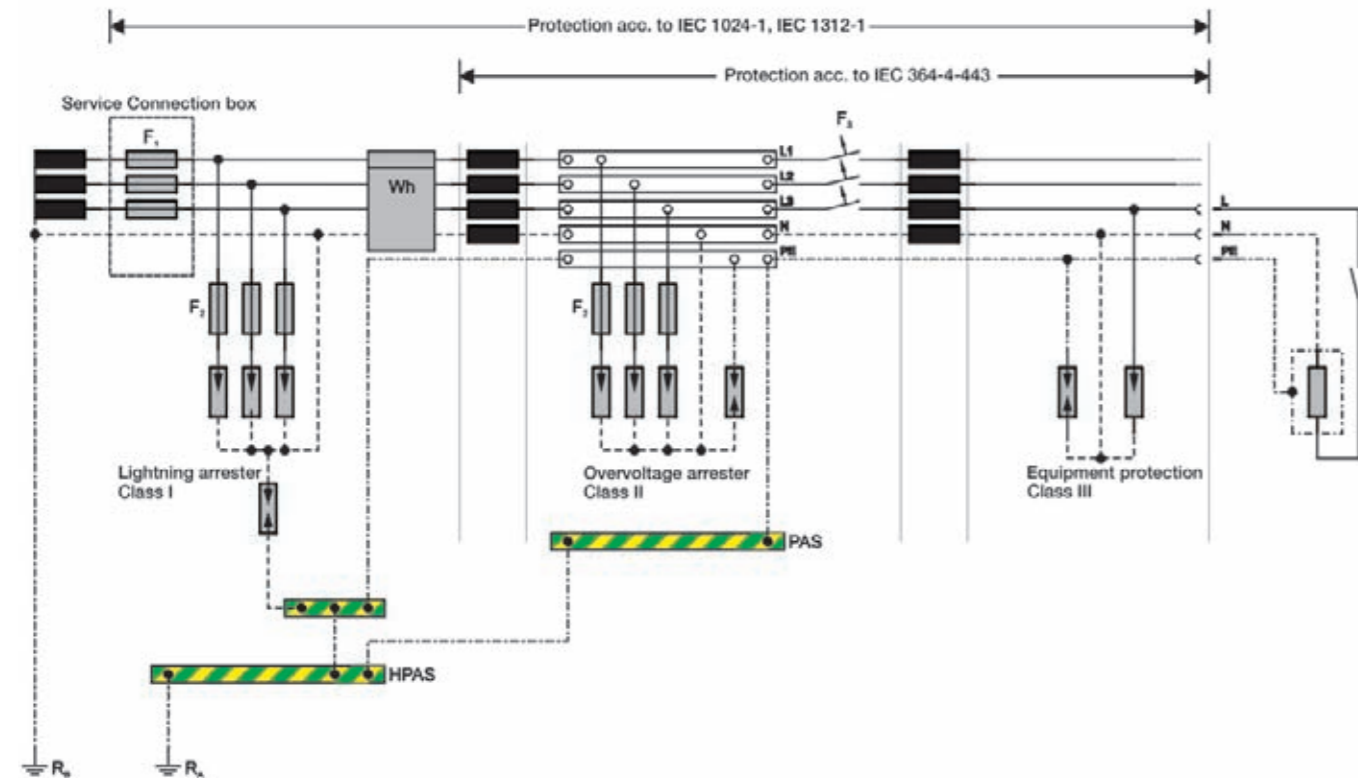

# Surge protection forum

## Construction standards/directives/legal basis

The availability of electrical and electronic equipment and systems is a decisive factor for the operator, at times for their continued existence. It is therefore important to prevent loss and faults that are frequently caused by overvoltage events. For this reason, the standards and directives relevant to this demand lightning and surge protection for buildings, parts of buildings, structural and technical installations (objects).

The IEC TC 81 technical committee deals with lightning protection all over the world. The new IEC 62305 international standard series was introduced by resolution in October 2001.

The first four of the planned five parts of the new IEC 62305 series have been with us since January 2006:

- IEC 62305-1: General principles
- IEC 62305-2: Risk management
- IEC 62305-3: Physical damage to structures and life hazard
- IEC 62305-4: Electrical and electronic systems within structures

The German committee K 251 responsible for implementation in Germany has decided to retain the VDE classification of the new series of standards of DIN EN 62305 as VDE 0185-305 parts 1-4.

This new series of standards will replace

the prestandards of the series DIN V VDE V 0185, which were published in November 2002, with a transition period (1 Feb 2009).

In future (from November 2006):

- DIN EN 62305-1 (VDE 0185-305-1):2006-11
- DIN EN 62305-2 (VDE 0185-305-2):2006-11
- DIN EN 62305-3 (VDE 0185-305-3):2006-11
- DIN EN 62305-4 (VDE 0185-305-4):2006-11

The draft standard part 5 is presently in the consultation phase.

It is known that lightning protection equipotential bonding is not sufficient in itself to protect electrical equipment from voltage surges.

On account of that, standards such as:

- DIN VDE 0100 part 410
- DIN VDE 0100 part 540
- DIN VDE 0100 part 443
- DIN V VDE V 0100 part 534
- DIN VDE 0800 part 1
- DIN VDE 0800 part 2
- DIN VDE 0800 part 10
- DIN VDE 0845 part 1
- DIN VDE 0845 part 2

explicitly require measures for protection against voltage surges.

In DIN VDE 0100, the surge protection measures for low-voltage installations and, in the DIN VDE 0800 series, the surge protection measures for communication engineering as a whole are described. Appendix A of DIN V VDE V 0100-534 shows the selectively graded use of surge arresters of class I (B arresters) in the main power supply, class II (C arresters) in the sub-circuit distribution board and class III (D arresters) in the area of the final circuit. Appendix A of DIN V VDE V 0100 part 534.

Since June 2001, E DIN IEC 60364-5-53/A2 (VDE 0100 part 534):2001-06 has been available in draft form. This is intended as the replacement for DIN V VDE V 0100-534.

The international equivalent is IEC 60364-5-53:2002-06.

The chapter 534: "Devices for protection against overvoltages" contains the devices for protection against overvoltages, the selecting of these and their use in the building installation. The rules that apply on the low voltage side are adapted to communication electronics as a whole and are described by the national series of standards 0800 parts 1, 2 and 10 and 0845 parts 1 and 2. DIN VDE 0800 describes general issues such as earthing, equipotential bonding, etc. and DIN VDE 0845 the measures for protecting against overvoltage events of all kinds.

### Guidelines of the loss insurers

The guidelines apply to decisions on whether lightning and surge protection is to be provided for buildings, parts of buildings, structural and technical installations. The guidelines become, on agreement, a binding part of the insurance contract between insurer and policyholder.

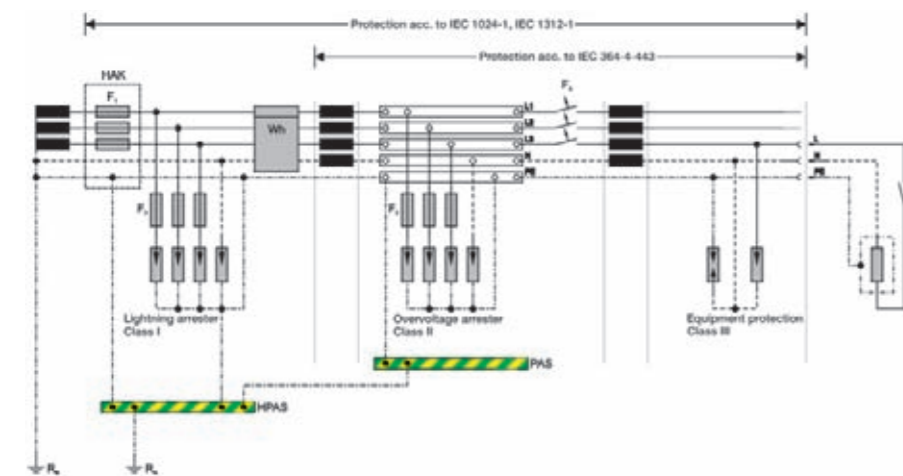

However, their application does not exempt the insured party from observance of legislation, statutory instruments, official requirements and generally accepted codes of practice such as that described in the DIN VDE standards. The building regulations of different countries and the relevant statutory and official regulations and codes of practice, call for lightning protection systems to be installed in certain buildings for reasons of public safety, e.g. in shops, hospitals, schools and children's homes, etc. The generally acknowledged code of practice, in this case DIN EN 62305 (VDE 0185-305):2006-11 or transitionally also DIN V VDE V 0185:2002-11, must be adhered to when installing technical systems. Issues relating to the installation arise not only in connection with official requirements but also when the insurers call for lightning protection, e.g. for high-racking warehouses or plants with a high risk of explosion. Similar relationships apply to surge protection. For example, DIN VDE 0100 part 443 specifies risk factors which determine the installation of surge protection measures.

The Association of German Property Insurers (VdS) publishes a number of documents covering particular applications, e.g. electrical installations, IT systems, agricultural businesses and residential buildings:

- VdS 2192: Leaflet on surge protection for loss prevention
- VdS 2014: Determining causes of damage due to lightning and surge
- VdS 2258: Protection against surge
- VdS 2006: Lightning protection by means of lightning arresters
- VdS 2017: Lightning and surge protection for agricultural businesses

- VdS 2031: Lightning and surge protection in electrical installations
- VdS 2028: Foundation earth electrodes for equipotential bonding and lightning protection earth termination
- VdS 2019: surge protection in residential buildings
- VdS 2569: surge protection for electronic IT systems
- VdS 2010: Risk-based lightning and surge protection
- VdS 2007: IT installations
- VdS 3428: surge protection devices

Furthermore, in Germany lightning protection is also covered in the construction law requirements of the individual federal states and also in national regulations. In light of this situation, the Association of German Property Insurers has produced a table to simplify the assignment of lightning protection classes and surge protection requirements to buildings and installations (VdS guideline 2010, 2005-07). This takes into account the experience and findings of loss prevention experts as well as legislation, official regulations and standards.

#### Legal basis

Basically, lightning and surge protection is not a mandatory provision in the form of legislation, even though lightning and surge protection is covered in Germany's EMC Act. However, it is important to know that there is indeed a legal basis. This comes into play when a loss event has occurred and, as a result, legal proceedings become relevant.

In Germany, the following legal aspects must be taken into account:

#### Civil law:

- **BGB (German Civil Code)**
  - cl. 633 Contractor's duty of warranty; removal of defects
  - cl. 276 Responsibility for one's own conduct
  - cl. 278 Responsibility for persons employed in performing an obligation
  - cl. 459 Liability for defect of quality
  - cl. 823b Unlawful actions

- **Produkthaftungsgesetz (Product Liability Act)**

- cl. 3 Identification of a defect/Competence

- **Gerätesicherheit (Safety of Equipment)**

- cl. 3 Code of practice

- **AVBEITV (General Conditions for Electricity Supplies to Standard-rate Customers)**

- Duty to observe the standards

#### Statutory instruments:

- **Gewerbeordnung (Trade and Industry Act)**

- cl. 24 Installations requiring monitoring
- cl. 120a Mortal danger and other health risks

- **VOB (Contract Procedures for Building Works)**

- cl. 3 Suspected defects
- cl. 4/2 Responsibility/Code of practice
- cl. 4/3 Written notification of concerns

**Basically, a person undertaking work is always liable for ensuring that his work is free from defects. The decisive starting point from which to establish whether work is free from defects is adherence to the generally accepted codes of practice.**

G



# Surge protection to ÖVE/ÖNORM E 8001-1

When the amendment of Electrical Engineering Regulation ETV 2002/A1 came into effect through the publication in the Federal Law Gazette of 30 January 2006, the amendment of ÖVE/ÖNORM E 8001-1/A2: 2003-11-01 also became binding.

The following transitional periods are defined:  
from the time the amendment came into effect, electrical installations must have been planned in accordance with these rules and, from 1 January 2007, their construction must also conform.

## ÖVE/ÖNORM E 8001-1/A2

**Section 18** contains the directives for protection of electrical installation against transient voltage surges. The requirements of this section should be regarded as minimum requirements.

Transient surge are rises in voltage due to atmospheric discharge (lightning) or switching actions introduced into the conductor system.

ÖVE/ÖNORM E 8049-1 deals with lightning protection of physical structures. The protection of networks other than low-voltage systems (e.g. data networks) is covered in other regulations (e.g. ÖVE-F1 part 7 for IT systems).

## ÖVE/ÖNORM E 8001-1/A2

**Section 18.2.2:** Protection against effects of lightning

**Section 18.2.2.1:** Protection against indirect effects of lightning is realised by type 2 surge protection devices.

For the installation of surge protection devices, the standard distinguishes between distribution networks and consumer installations.

### Low-voltage distribution systems:

**Section 18.2.2.1.1:** Surge protection devices that protect against indirect effects of lightning must be installed in overhead systems and in mixed overhead /cable systems.

### Consumer installations:

**Section 18.2.2.1.2:** Surge protection devices against indirect effects of lightning must be installed in every consumer installation.

**Section 18.2.2.2:** Protection against indirect effects of lightning, if required, is to be realised by type 1 surge protection devices, and if required, additionally by surge protection devices of types 2 and/or 3.

## ÖVE/ÖNORM E 8001-1/A2

**Section 18.3:** Installation of surge protection devices of types 1 and/or 2, and

**Section 18.4.3:** Selection of maximum continuous voltage (Uc)

In a **TN-C system**, arresters are incorporated between each phase conductor and the PEN conductor. The maximum continuous voltage of surge protection devices must be at least 1.1 times the phase-to-neutral potential difference.

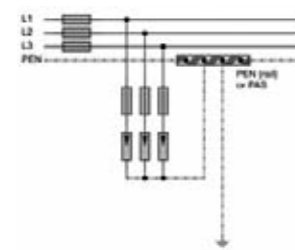

In a **TN-S system**, arresters are installed – in the 4+0 system

– between each of the phase conductors and the PE rail or main earthing bar and between the neutral conductor and PE rail or main earthing bar. The maximum continuous voltage of surge protection devices between the phase conductor and PE rail or main earthing bar must be at least 1.1 times the value of the phase-to-neutral potential difference and between the neutral conductor and PE rail or main earthing bar at least equal to this value.

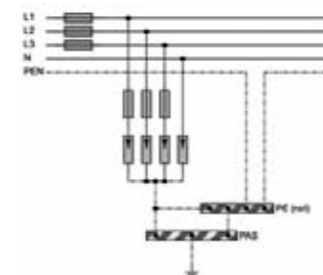

– in the 3+1 system

between the phase conductors and neutral conductor as well as between the neutral conductor and PE rail or main earthing bar. The maximum continuous voltage of surge protection devices between the phase conductor and neutral conductor must be at least 1.1 times the value of the phase-to-neutral potential difference and between neutral conductor und PE rail or main earthing bar at least equal to this value.

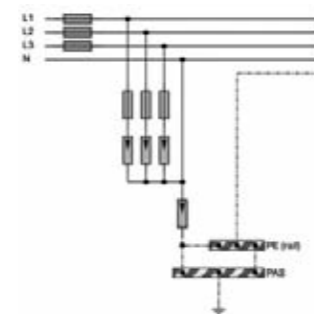

In the **IT system with distributed neutral conductor** arresters are installed between each phase conductor and the PE rail or main earthing bar as well as between the neutral conductor and PE rail or main earthing bar. The maximum continuous voltage of surge protection devices between the phase conductor and PE rail or main earthing bar must be at least  $\sqrt{3}$  times the value of the phase-to-neutral potential difference and between the neutral conductor and PE rail or main earthing bar at least equal to this value.

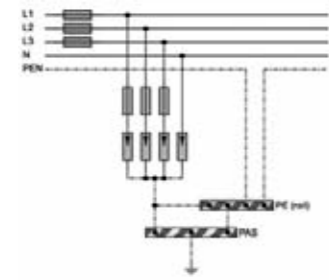

– in the 3+1 system between the phase conductors and neutral conductor as well as between neutral conductor and PE rail or main earthing bar. The maximum continuous voltage of surge protection devices between phase conductor and neutral conductor must be at least 1.1 times the value of the phase-to-neutral potential difference and between neutral conductor and PE rail or main earthing bar at least equal to this value.

In the **IT system without neutral conductor**, arresters are installed between each phase conductor and PE rail or main earthing bar. The maximum continuous voltage of surge protection devices must be at least equal to the value of the phase-to-neutral potential difference.

In the **TT network**, arresters are installed – in the 4+0 system with additional arrester disconnecter between each phase conductor, the arrester disconnecter and PE rail or main earthing bar and between the neutral conductor, arrester disconnecter and PE rail or main earthing bar. The maximum continuous voltage of surge protection devices between the phase conductor, arrester disconnecter and PE rail or main earthing bar must be at least 1.1 times the value of the phase-to-neutral potential difference and between the neutral conductor, arrester disconnecter and PE rail or main earthing bar at least equal to this value. The arrester disconnecter must possess a minimum surge current strength of at least 10 kA 8/20  $\mu$ s for single-phase consumer installations and at least 20 kA 8/20  $\mu$ s for 3-phase consumer installations.

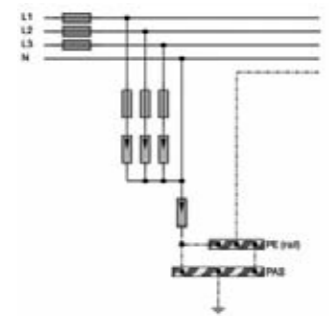

**In all network forms**, an arrester can optionally be installed between the phase conductors. The maximum continuous voltage of surge protection devices must be at least 1.1 times the value of the phase voltage. The quoted selection criteria relate, in accordance with ÖVE/ÖNORM E 8001-1/A2 Section 18.4.1, to surge protection devices as per ÖVE/ÖNORM EN 61643-11. Where other surge protection devices are used, the appropriate verifications must be furnished.

**Section 18.4.2:** Selection of protection level ( $U_p$ )

For protection against indirect effects of lightning, the maximum protection level for a consumer installation with a voltage rating of 230/400 V (phase-to-neutral potential difference 1300 V) is 2500 V. For a consumer installation with a voltage rating of 400/690 V (phase-to-neutral potential difference 1600 V), the maximum protection level is 4000 V. For a consumer installation with a voltage rating of 1000 V (phase-to-neutral potential difference 1000 V), the maximum protection level is 6000 V. For protection against direct effects of lightning, the same values apply for selection of the protection level as for protection against indirect effects of lightning.

Voltage rating of consumer installation	Phase-to-neutral conductor (a.c. or d.c.) V	Maximum protection level V
	to 50	500
	over 50 to 100	800
	over 100 to 150	1500
230/400	over 150 to 300	2500
400/690	over 300 to 600	4000
1000	over 600 to 1000	6000





**Country-specific standards and directives**

If it is not possible to provide the required protection level with an overvoltage device or a set of surge protection devices, additional surge protection devices that are coordinated to each other must be installed.

**ÖVE/ÖNORM E 8001-1/A2**

**Section 18.4.4:** Selection in respect of temporary overvoltages (TOVs).

TOV is an overvoltage of relatively long duration oscillating at mains frequency that is not or only weakly attenuated. Overvoltage protection devices must satisfy the requirements of ÖVE/ÖNORM EN 61643-11:2003, Section 7.7.4. The Weidmüller surge protection device is tested to these standards.

**ÖVE/ÖNORM E 8001-1/A2**

**Section 18.4.5:** Selection of rated discharge current ( $I_n$ ) and lightning surge current ( $I_{imp}$ )

**Section 18.4.5.1:** For protection against indirect effects of lightning, the rated discharge current of surge protection devices must be at least 5 kA 8/20  $\mu$ s per protective path (e.g. L-N, L-PE). Where the 3+1 system is used, the rated discharge current of the surge protection device between neutral conductor and PE conductor for 3-phase supplies must be at least 20 kA 8/20  $\mu$ s and for single-phase supplies, at least 10 kA 8/20  $\mu$ s.

**Section 18.4.5.2:** For protection against direct effects of lightning, the rated discharge current of surge protection devices must be at least 12.5 kA per protective path (e.g. L-N, L-PE). Where the 3+1 system is used, the rated discharge current of the surge protection device between neutral conductor and PE conductor for 3-phase supplies must be

at least 50 kA and for single-phase supplies, at least 25 kA.

These minimum requirements correspond to lightning protection classes III and IV as per ÖVE/ÖNORM E 8049-1.

**ÖVE/ÖNORM E 8001-1/A2**

**Section 18.6:** Protection for overcurrent

Short circuit protection must be guaranteed by the correct choice of overcurrent protection device. These overcurrent protection devices have to be less than or equal to the maximum permissible overcurrent protection stated by the manufacturer.

**ÖVE/ÖNORM E 8001-1/A2**

**Section 18.8:** Installation in conjunction with residual current protection devices.

**Section 18.8.1.:** The installation of type 1 surge protection devices after residual current protection devices (RCDs) is not permissible, except when the surges are to be expected on the load side of the residual current protection device.

**Section 18.8.2.:** The installation of type 2 surge protection devices after residual current protection devices is only permissible when type 2 surges protection devices are already installed before the residual current protection device in accordance with 18.4.5, or the surges are to be expected on the load side of the residual current protection device.

**Section 18.8.3.:** If surge protection devices are installed after a residual current protection device, time-delayed residual current protection devices of type G or S (ÖVE-SN 50 or ÖVE EN 61008) must be installed. (in accordance with ÖVE/ÖNORM 8001-1, section 12.1.6, mandatory for circuits where damage or

injury is possible in the event of false tripping.)

False tripping of residual current protection devices can occur where discharge currents are more than 3 kA or where an arrester has failed.

**ÖVE/ÖNORM E 8001-1/A2**

**Section 18.11:** Connecting wires

The connecting wires of arresters and also earth wires should be as short as possible and should have no loops (low-impedance routing).

**ÖVE/ÖNORM E 8001-1/A2**

**Section 18.12:** Cross-section of connecting wires

The cross-section of connecting wires for type 2 surge protection devices is at least 4 mm<sup>2</sup> copper.

The cross-section of connecting wires for type 1 surge protection devices is at least 16 mm<sup>2</sup> copper.

However, the cross-section must be greater if the maximum possible short circuit current requires it. All arresters – with the exception of arresters between neutral conductor and main earthing bar or PE rail - must be protected against short circuit currents by an upstream overcurrent protection device. In the IT system with distributed N conductor, the 3+1 system should be installed. In rooms at risk of fire or explosion, additional special measures must be taken.

# Standard texts for surge protection tenders

You will find standard, up-to-date texts for tender documents at our Internet site [www.weidmueller.com](http://www.weidmueller.com) – select language: German. These will help you draw up the specification to suit your installation.

The advantage of this is that you can download the correct, up-to-date technical information from our Internet site at any time.

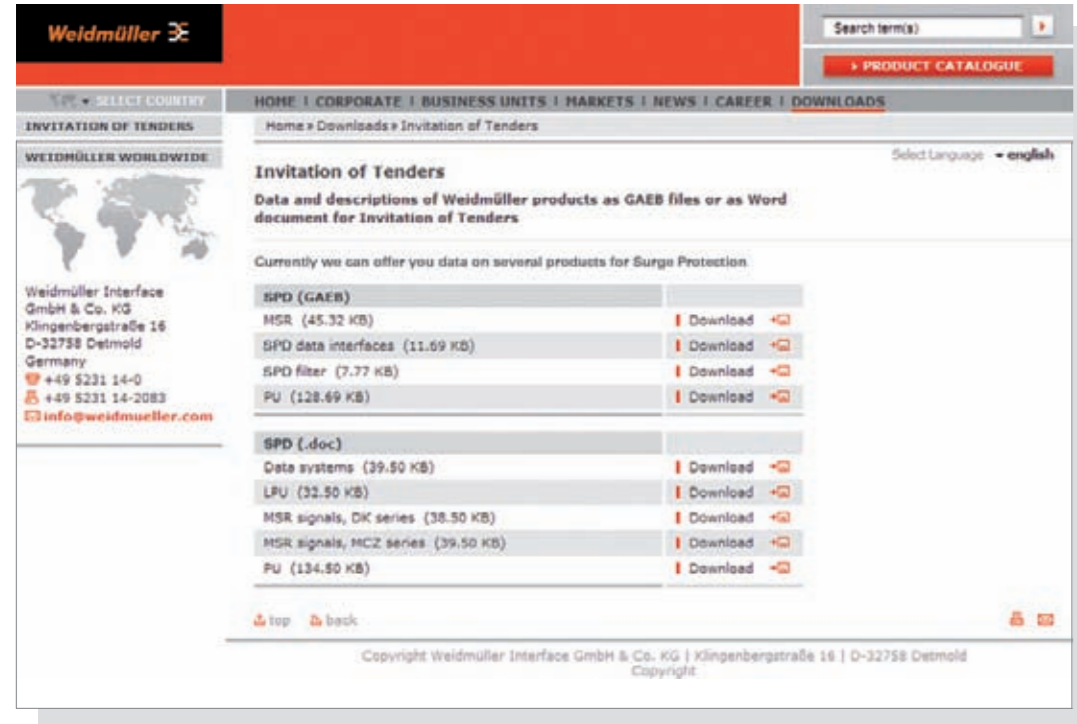



## FAQ list

### When do I need a class I arrester, when a class II arrester?

In a lightning protection system set up on a building, the class I arrester achieves the lightning protection equipotential bonding for the supply voltage. The class I arrester is used when higher pulses are expected and is installed in the vicinity of the incoming supply.

Under DIN VDE 0185 part 1 (Nov 1982), the class I arrester is intended for use in lightning protection equipotential bonding. It also satisfies the requirements of class B to DIN VDE 0675 (draft, Nov 1989) and IEC 61643-1, class I. The class II arrester serves to protect low-voltage consumer installations and electronic devices against surge that can ensue as a result of atmospheric discharges (lightning) or switching actions. The class II arrester complies with VDE 0675 part 6, class C (draft, Nov 1989), DIN VDE 0675 part 6, A2 (Oct 1996), and ÖVE SN 60 parts 1 and 4, as well as IEC 61643-1-1, class II. High-power metal oxide varistors are employed as a voltage limiter in PU BC class I and PU II class II arresters.

### When is a decoupling inductance needed?

When using Weidmüller arresters of class I and II based on varistors, no decoupling inductance is needed. The PU1 TSG operates with a triggered sparkover gap. The fast response and low protection level mean that no decoupling is required here either.

### How should the network protection PU be fused?

The terminal compartment of the PU II is designed according to IEC 61643-1 and can accommodate 4 mm²... 25 mm². According to DIN VDE 0100 part 430: load capacity, cables or conductors for permanent installations, installation types A, B1, B2 and C as for installation type E, outdoors, and assignment of overcurrent protection devices for protection in case of overload.

According to this, a current rating  $I_n$  of 125 A for single wires (max. 2 wires) and a current rating  $I_n$  of 100 A for single wires (max. 3 wires) applies to 35 mm<sup>2</sup> copper when laid on or in walls or under plaster. It is therefore left to the builder of the installation to decide which types of lines are employed. If single-core wiring with 35 mm<sup>2</sup> is installed, this can be protected with a 125 A fuse and the PU can be connected with this. If multi-core wiring (NYM 3 x 35 mm<sup>2</sup>) is chosen, a 100 A fuse must be used. The PU modules do not constitute an electrical load but rather only operate when surge have to be discharged.

### Why are there 3- and 4-pole versions?

Various arresters are used depending on the network structure. A widely used network structure is the TN system. In the TN-C system, the electricity supply company routes the potential of the operational earth of the low-voltage source (transformer) to the consumer installation via the integral PEN conductor. The PE conductor has the same potential as the N conductor in this case. A 3-pole arrester is used here. Every rule has an exception: in the TN-S system, PE and N are separate. This means there can be a potential shift between PU and N. A 4-pole PU is used in this case.

In addition, a combination of 3 or 4-pole modules reduces the amount of wiring.

### What other network structures are available?

#### TT system

In the TT system, class I and class II arresters as surge protection devices are not used between the active conductors and the earth potential as in TN systems, but instead between phases L1, L2 and L3 and the neutral conductor. Why? In the “classic” arrangement of surge protection devices between the phases and the earth potential, these may towards the end of their service life become incapable of suppressing system follow currents, can show signs of ageing or even cause short-circuits. A fault current then flows back to the supplying source depending on the actual earthing resistance of the consumer installation. Generally, the relatively high loop resistances in TT systems mean that fuses carrying operating current do not detect this fault current as a malfunction and thus do not disconnect quickly enough. This can lead to an increase in potential throughout the equipotential bonding system of the building. If this consumer installation supplies buildings that are some distance away, or if consumers outside the effective area of the equipotential bonding system of the building are operated via mobile conductors, dangerous accidental energisation can occur. This is where the 3+1 circuit can be useful.

#### IT system

An IT system is set up in some consumer installations for reasons of availability. A single-phase earth fault practically creates a TN system. The power supply is not

interrupted but instead maintained.

IT systems are used in medical applications, for example. A device for monitoring insulation provides information on the quality of the insulation of active conductors and connected consumers in relation to the earth potential. Surge protection devices are incorporated between the active conductors and the main equipotential bonding. The fuses, conductor cross-section and conductor routes are handled as for T systems. Likewise, all active conductors are protected against local earth potential in sub-circuit distribution boards. PU D surge protection devices are used to protect sensitive consumers. Arresters must be designed for the phase-to-phase voltage.

**What is so good about the 3+1 circuit?**

**3+1 circuit**

If PU II modules (class II arresters) in a TT system are no longer routed to the local earth but to the neutral conductor, only the line resistance of the neutral conductor limits the arising follow current in the event of the PU modules acquiring a low resistance. After the occurrence of the fault, this is immediately disconnected from the spur line fuses or the main fuses carrying operating current. The earthing system resistance opposing the fault current has turned it into a pure short-circuit current! The connection between neutral conductor and main equipotential bonding circuit is achieved with a sparkover gap. This is capable of carrying the total surge currents occurring at the place of installation without being overloaded (PU II 3+1 280 V). This 3+1 system is also used in the sub-circuit distribution boards. Phase conductors L1, L2 and L3 are connected to the neutral conductor via the PU II 3+1 280 V. A sparkover gap is

installed between there and the PE rail. The treatment of local equipotential bonding systems as well as separate systems for diverting voltages to the equipotential bonding system and the arrangement of PU modules before residual-current circuit-breakers is the same as that described for TN systems.

**How does monitoring work with PU II modules?**

Each individual disc of PU II modules is equipped with a thermal monitoring device. This represents the state of the art and disconnects the ageing arrester from the mains supply, thus avoiding a fire. This thermal monitoring device works with special solder that unsolders within around 30 s when a current of 0.2 A passes through the varistor. This is required under ÖVE SN 60 and other standards. Readiness for operation is usually indicated by a green flag in the status window or, in the case of PU II modules with telecommunication output, via a changeover contact. The PU II modules are plug-in units and are therefore easy to replace.

**Does the PU continue working after an overvoltage event?**

Yes, if the discharge current for each individual disc remains below 40,000 A. However, each discharge process ages the varistor. This ageing effect accumulates over the service life of the unit and after several years causes the arrester to fail. But this situation can be monitored.

**Which standards apply for the testing of PU modules?**

PU II and PU BC are tested to IEC 61643-1, which corresponds to DIN VDE 0675, part 6 (Dec 2002). Arresters of the

PU II series conform to class II. PU BC arresters conform to classes II and I. The PU III and PU D series was developed and tested in accordance with the requirements of IEC 61643-1 and DIN VDE 0675, part 6 (Dec 2002).

**Where are the PU modules installed?**

The dimensions of PU modules for distribution boards comply with DIN 43880 A1 (draft, June 1981). Arresters of class I are positioned near the incoming supply and the main equipotential bonding system, arresters of class II in the distribution board and PU III in the sub-distribution boards, near to the object to be protected. Appropriate insulation resistances for the various parts of the system are required according to the insulation coordination specifications of DIN VDE 0110. One way of achieving this is by the graded utilisation of arresters of class I, II and III.

**What do I need to watch out for when installing PU modules?**

IEC 60364-5-53 describes the selection and installation of surge protection in buildings worldwide. The German prestandard DIN V VDE V 0100-534 describes the selection and installation of equipment for surge protection systems.

**What is the difference when using a sparkover gap instead of a varistor?**

Modern power networks are fed into the building via underground cables. Part of the lightning energy is absorbed by attenuation of the supply line. The full lightning energy is not expected here. A sparkover gap is characterised by high discharge capacity (approx. 50 kA) and the time to sparkover is in the order of



## Questions and answers concerning surge protection

microseconds. To suppress the follow current, sparkover gaps require a special design, sometimes in the form of arcing spaces. A decoupling device must be installed between sparkover gap and downstream varistors. The varistor-based design of the PU BC is capable of discharging a lightning test current (10/350  $\mu$ s) of up to 16 kA.

The response time of the sparkover gap in this case lies in the nanosecond range. The varistors do not draw any power follow current.

### What are triggered sparkover gaps?

These sparkover gaps have additional electronics. They “see” the interference pulse and ignite the sparkover gap. This means that the protection level is kept low and the time to sparkover is reduced. This saves on decoupling coils.

### When should I use the CL or SL circuit with the MCZ OVP?

The difference between the switching in the CL (current loop) and SL (symmetrical loop) is the integration of the suppressor diodes. The CL circuit has a diode between the lines. This system is used for current loops and offers direct protection at the input or output of the analogue sensor.

The SL circuit operates symmetrically to earth, i.e. two Transzorb diodes are connected to earth. If this is used in a current loop instead of the CL circuit, the residual voltage is twice as high because there are two diodes instead of just the one of the CL circuit.

### Why are combination circuits available?

The use of GDTs (gas discharge tubes), MOVs (varistors) and TAZs (Tranzorb diodes) besides attenuators such as coils and resistors bring about advantages for different interference pulses. If a high, steep-flanked pulse is present, the GDT responds and diverts the fault. If the pulses are weaker and not as fast, the GDT doesn't operate and the entire load is diverted via the MOV and the TAZ. This means that a combination achieves an optimum protection level depending on the incoming pulse. The use of single components means that only one characteristic can be utilised.

# Glossary

<b>3+1 circuit</b>	Surge protection for TT/TNS systems with three varistors and one N-PE spark-over gap; avoids accidental energisation in the case of defective varistors.
<b>ageing</b>	A change in the original performance data caused by interference pulses, operation or unfavourable ambient conditions.
<b>arrester</b>	Protective device that discharges energy symmetrically between the conductors or asymmetrically between the conductors and earth.
<b>arrester disconnecter</b>	Device to isolate an arrester from the mains power supplies in the case of a failure and also to indicate this.
<b>asymmetric interference voltage</b>	Bestimmt zum Zweck des Blitzschutzpotentialausgleiches nach DIN VDE 0185-1,
<b>Backup fuse</b>	Max. fuse rating to be provided depending on conductor cross-section and/or longitudinal decoupling.
<b>binary signals</b>	Switching signals with the status ON and OFF
<b>capacitive coupling</b>	Coupling of interference circuit and useful circuit via coupling capacitances owing to a difference in potential.
<b>class B/ T1/ KI.I (previously class B)</b>	Prescribed for the purpose of lightning protection equipotential bonding to DIN VDE 0185 part 1 (see also class I).
<b>class C/ T2/ KI.II (previously class C)</b>	Prescribed for the purpose of surge protection in a permanent installation, preferably for use in impulse test voltage category III (see also class II).
<b>class D/ T3/ KI.III (previously class D)</b>	Prescribed ribed for the purpose of surge protection in a permanent installation, preferably for use in impulse test voltage category II (see also class III).
<b>class I</b>	Prescribed for the purpose of lightning protection equipotential bonding to IEC 37A/44/CDV (see also class B).
<b>class II</b>	Prescribed for the purpose of surge protection in a permanent installation, preferably for use in impulse test voltage category III (see also class B).
<b>class III</b>	Prescribed for the purpose of surge protection in a permanent installation, preferably for use in impulse test voltage category II (see also class D).
<b>class of protection of housing (IP code)</b>	Degree of protection that the housing provides against coming into contact with conductive parts as well as the ingress of solid foreign bodies or water; tested according to IEC 529 section 7.4.
<b>combined circuit</b>	Protective circuit comprising, for example, gas discharge tube, varistor and/or suppression diode.
<b>combined surge</b>	The hybrid generator generates a $1.2/50 I_b$ pulse during no-load operation and an $8/20 \mu s$ pulse during a short-circuit; the ratio of no-load peak voltage $U_{oc}$ to shortcircuit peak current $I_{sc}$ is 2 W.
<b>common-mode interference</b>	Interference source lies between signal wire and reference conductor (e.g. capacitive coupling or increase in potential of separate earths).
<b>conductive coupling</b>	Interference circuit and useful circuit have a common impedance (conducted).
<b>continuous operating current <math>I_c</math></b>	Current per protective path at continuous voltage $U_c$ .
<b>DK4U</b>	Slimline modular protective terminal with varistor or gas discharge tube or suppression diode.
<b>DK5U</b>	Slimline modular protective terminal with combined circuit for current loops, with screw connection.
<b>DK6U</b>	Slimline modular protective terminal with combined circuit for 120 and 230 V current loops, with screw connection.
<b>DKU</b>	Slimline modular protective terminal with combined circuit for binary signals, with screw connection.

G



**Glossary**

<b>EGU 1</b>	Surge protection in build-in housing with gas discharge tube and varistor for binary signals, with fuse and voltage indicator.
<b>EGU 2</b>	Surge protection in build-in housing with gas discharge tube, varistor and suppression diode for binary signals, with fuse and voltage indicator.
<b>EGU 3</b>	Surge protection in build-in housing with gas discharge tube and varistor for 50 mA and 1.5 A current loops.
<b>EGU 4</b>	Surge protection in build-in housing with gas discharge tube, varistor and suppression diode for 100 mA and 1.5 A current loops.
<b>EMV EMC</b>	Electromagnetic Compatibility
<b>follow current <math>I_f</math></b>	Current that flows through a surge protection device after the discharge process and is fed from the mains power supplies.
<b>gas discharge tube (GDT)</b>	Enclosed switch with high current-carrying capacity depending on voltage.
<b>inductive coupling</b>	Coupling through two or more conductor loops through which current is flowing.
<b>insertion loss</b>	Attenuation in decibels added to a circuit by inserting a four-pole network.
<b>Insta</b>	Installation housing to DIN 43880, suitable for incorporating in a distribution board.
<b>insulation coordination</b>	Current impulse strength of the insulation in installation sections, to DIN VDE 0110 part 1.
<b><math>I_{peak} = I_{imp}</math></b>	Peak current value of test impulse.
<b><math>I_{sn}</math></b>	Peak value of rated discharge current.
<b>IT system</b>	Network with three phase conductors insulated with respect to earth potential; the PE of the building is not connected to the network.
<b>leakage current</b>	Current discharged to PE at rated voltage.
<b>LEMP</b>	Lightning Electromagnetic Pulse
<b>lightning surge current <math>I_{imp}</math></b>	Defined by the peak current value $I_{peak}$ and the charge Q in the test according to class I with 10/350 $\mu$ s pulse.
<b>limit frequency</b>	Specifies the maximum frequency at which transmission still functions; at higher frequencies the protective circuit attenuates so severely that transmission is no longer possible.
<b>longitudinal voltage</b>	Interference voltage between active conductor and earth.
<b>LPZ</b>	Lightning Protection Zone
<b>max. continuous voltage <math>U_c</math></b>	The highest effective value of the AC voltage or the highest value of the DC voltage that is allowed continually on the protective path of the surge protection device. Continual voltage = rated voltage.
<b>max. discharge current <math>I_{max}</math></b>	Peak value of 8/20 $I_s$ current in class II (type 40 kA) operating duty test.
<b>MCZ sp</b>	Slimline modular protective terminal with tension spring connection and mounting rail contact for PE.
<b>measured limiting voltage</b>	Maximum voltage during the action of surges with a predefined impulse wave shape and amplitude in a test.
<b>MOV</b>	see "varistor".
<b>normal-mode interference</b>	Interference source and useful source are in series (e.g. magnetic or conductive coupling).
<b>PE</b>	Protective and earthing system to which energy is discharged.
<b>protection level <math>U_p</math></b>	Specifies the residual voltage that can still be measured at the terminals during a surge impulse (preferred value – larger than maximum measured limiting voltage); key parameter characterising the performance of a surge protection device.



<b>protective path</b>	Circuit of the components of a surge protection device; conductor to conductor, conductor to earth, conductor to neutral conductor, and neutral conductor to earth are designated as protective paths.
<b>PU BC</b>	Combined surge arrester of classes I and II in an Insta housing for discharging high pulses in power systems.
<b>PU II</b>	Surge arrester of class II in an Insta housing for extracting pulses in power systems.
<b>radiation coupling</b>	Electromagnetic field coupled in one or more conductor loops.
<b>rated discharge current In</b>	Peak value of 8/20 $\mu$ s surge current in class II (type 20 kA) test.
<b>RCD</b>	see "residual current circuit-breaker"
<b>residual current circuit-breaker</b>	If a fault current exceeds a certain threshold, the residual current circuit-breaker is tripped within 0.2 s.
<b>RSU</b>	Surge protection on clip-on base, with gas discharge tube, varistor and suppression diode for 6 and 10 A current loops.
<b>short-circuit strength</b>	Maximum non-influenced short-circuit current that a surge protection device can withstand.
<b>SPD</b>	Surge Protection Device
<b>suppression diode</b>	Fast-acting (depending on voltage) semiconductor diode.
<b>Surge (overvoltage)</b>	Unwanted continuous or brief potential difference between conductors or between conductor and earth that causes interference or damage.
<b>surge current 8/20 <math>\mu</math>s</b>	Lightning test current with a front time of 8 $\mu$ s and a time to half-value of 20 $\mu$ s.
<b>surge current 10/350 <math>\mu</math>s</b>	Lightning test current with a front time of 10 $\mu$ s and a time to half-value of 350 $\mu$ s.
<b>Surge protection (SP)</b>	Circuit or wiring in a circuit to limit the output voltage.
<b>Surge protection classes</b>	Classification of electrical equipment according to its voltage strength related to the rated voltage (EN 50178).
<b>Surge protection device</b>	Unit with at least one non-linear component for limiting transient surges and discharging surge currents.
<b>Surge protection installation</b>	Device(s), including lines, to protect against surges.
<b>surge voltage 1.2/50 <math>\mu</math>s</b>	Surge voltage with a front time of 1.2 $\mu$ s and a time to half-value of 50 $\mu$ s.
<b>symmetric interference voltage</b>	Voltage between forward and return conductor (normal-mode voltage).
<b>TAZ</b>	see "suppression diode"
<b>time to sparkover</b>	Reaction times vary from a few microseconds to picoseconds depending on type and structure of protective module.
<b>TN system</b>	Network consisting of four or five conductors; three phase conductors and PEN enter the building; PE of building and PE of mains are connected together.
<b>transverse voltage</b>	Interference voltage between two conductors of a circuit.
<b>triggered sparkover gap</b>	A gas-filled sparkover gap that is fired at a preset voltage value by a capacitive discharge device.
<b>TT system</b>	Network consisting of four conductors, three phase conductors and N conductor enter the building; PE of building is not connected to mains.
<b>unsymmetrical interference voltage</b>	Voltage between conductor and reference potential (earth).
<b>varistor</b>	Voltage-dependent metal oxide resistor whose resistance decreases as the voltage increases.

G







# Index

<b>Index</b>	Index Type / Index Order No.	X.2
	Addresses worldwide	X.10

Type	Order No.	Page	Type	Order No.	Page	Type	Order No.	Page	Type	Order No.	Page
<b>A</b>			<b>F</b>			PO D S	8581840000	C.4	FU II 3 EWS 280V/40kA	8859800000	C.3
AD 4 AKZ4	0303400000	D.27	F Connector / M-F	8947840000	E.9	PO D S	1115500000	C.49	FU II 3 LCF 280V/20kA	8859760000	C.27
AP DK4	0359260000	D.26			PS 2,3 RT	0180400000	D.26	FU II 3 LCF 280V/20kA	8859760000	C.3	
AP DK4	0359260000	D.27			PU 1 TSG 100kA/1,5 kV	0180400000	D.27	FU II 3 R 130V/40kA	8860000000	C.3	
AP DK4	0359260000	D.52			PU 1 TSG 100kA/1,5 kV	8762020000	C.15	FU II 3 R 130V/40kA	8860000000	C.34	
AP DK5 PA BE	4036780000	D.53	ISPF QB75 SW	0526700000	D.26	PU 1 TSG 35kA / 0,9kV	8762020000	C.2	FU II 3 R 280V/40kA	8859650000	C.24
AP DK14 PA	0687560000	D.49	ISPF QB75 SW	0526700000	D.27	PU 1 TSG 35kA / 0,9kV	8561260000	C.14	FU II 3 R 280V/40kA	8859650000	C.3
					PU 1 TSG 35kA / 0,9kV	8561260000	C.2	FU II 3 R 385V/40kA	8859850000	C.3	
					PJ BC 16kA/280V	8805440000	C.13	FU II 3 R 385V/40kA	8859850000	C.30	
					PJ BC 16kA/280V	8805440000	C.2	FU II 3 R 550V/40kA	8860090000	C.3	
					PJ BCR 16kA/280V	8805450000	C.13	FU II 3 R 550V/40kA	8860090000	C.38	
B			J			PU BCR 16kA/280V	8805450000	C.2	FU II 3 R EWS 280V/40kA	8859820000	C.28
BFSC M2.5X18 PA/RT	0303300000	D.26	JPOVP 24VDC MOV M12	8760960000	D.32	FU COMBI I-II 4 Wire	8729980000	C.2	FU II 3 R EWS 280V/40kA	8859820000	C.3
BFSC M2.5X18 PA/RT	0303300000	D.27	JPOVP 24VDC ANA M12	8760970000	D.34	PU COMBI I-II 4 Wire	8729980000	C.20	FU II 3 R LCF 280V/20kA	8859780000	C.27
BNC Connector / M-F	8947820000	E.8	JPOVP M12 D-coded Cat5	8760980000	D.34	PU COMBI I-II 5 Wire	8729980000	C.2	FU II 3 R LCF 280V/20kA	8859780000	C.2
			JPOVP M12 D-coded Cat5	8805570000	D.32	PU COMBI I-II 5 Wire	8729950000	C.21	FU II 3+1 280V/40kA	8859710000	C.26
			JPOVP M12 D-coded Cat5	8805570000	D.32	PU D ZS 230V - 16A / ISDN So	8697560000	D.3	FU II 3+1 280V/40kA	8859710000	C.3
			JPOVP RJ45 Cat6 IP20	8805550000	D.2	PU D ZS 230V - 16A / ISDN LK6	8697570000	D.3	FU II 3+1 385V/40kA	8859880000	C.3
			JPOVP RJ45 Cat6 IP20	8805550000	D.33	PU D ZS 230V - 16A / ISDN LK6	8697570000	D.3	FU II 3+1 385V/40kA	8859880000	C.32
			JPOVP RJ45 Cat6 IP67	8805560000	D.2	PU D ZS CAT.6	8805530000	D.2	FU II 3+1 385V/40kA	8859720000	C.26
			JPOVP RJ45 Cat6 IP67	8805560000	D.33	PU D ZS TV/R	8779230000	D.3	FU II 3+1R 280V/40kA	8859720000	C.3
					PU DS 24Vuc 16A	8682100000	D.2	FU II 3+1R 280V/40kA	8859720000	C.28	
					PU DS 48V 16A	8670740000	D.2	FU II 3+1R 385V/40kA	8859890000	C.3	
					PU 11 280V/12,5kA	8859050000	C.12	FU II 3+1R 385V/40kA	8859890000	C.32	
					PU 11 280V/12,5kA	8859060000	C.12	FU II 4 130V/40kA	8860010000	C.3	
					PU 11+1TSG+ 350V 1,5kV	8860500000	B.87	FU II 4 130V/40kA	8860010000	C.34	
					PU 11TSG+ 350V 1,5kV	8860480000	B.87	FU II 4 280V/40kA	8859640000	C.24	
					PU 12 280V/12,5kA	8859040000	C.12	FU II 4 280V/40kA	8859640000	C.3	
					PU 12 R 280V/12,5kA	8859030000	C.12	FU II 4 385V/40kA	8859860000	C.30	
					PU 13 280V/12,5kA	8858990000	C.11	FU II 4 385V/40kA	8859860000	C.3	
					PU 13 280V/12,5kA	8858990000	C.2	FU II 4 550V/40kA	8860060000	C.38	
					PU 13 R 280V/12,5kA	8859010000	C.11	FU II 4 550V/40kA	8860060000	C.38	
					PU 13+1R 280V/12,5kA	8859010000	C.2	FU II 4 EWS 280V/40kA	8859810000	C.28	
					PU 13+1TSG+ 350V 1,5kV	8859080000	B.85	FU II 4 EWS 280V/40kA	8859810000	C.3	
					PU 13TSG+ 350V 1,5kV	8859090000	B.85	FU II 4 LCF 280V/20kA	8859770000	C.27	
					PU 14 280V/12,5kA	8859000000	B.86	FU II 4 LCF 280V/20kA	8859770000	C.3	
					PU 14 280V/12,5kA	8859000000	C.11	FU II 4 R 130V/40kA	8860020000	C.3	
					PU 14 280V/12,5kA	8859000000	C.2	FU II 4 R 130V/40kA	8860020000	C.34	
					PU 14 R 280V/12,5kA	8859020000	C.11	FU II 4 R 280V/40kA	8859660000	C.24	
					PU 14 R 280V/12,5kA	8859020000	C.11	FU II 4 R 280V/40kA	8859660000	C.3	
					PU 14 R 280V/12,5kA	8859020000	C.2	FU II 4 R 385V/40kA	885970000	C.30	
					PU 14 R 280V/12,5kA	8859030000	C.3	FU II 4 R 385V/40kA	885970000	C.3	
					PU 14 R 550V/40kA	8859750000	C.3	FU II 4 R 550V/40kA	8860070000	C.3	
					PU 14 R 550V/40kA	8860120000	C.3	FU II 4 R 550V/40kA	8860070000	C.38	
					PU 14 R EWS 280V/40kA	8871950000	C.3	FU II 4 R EWS 280V/40kA	8859830000	C.28	
					PU 14 R EWS 280V/40kA	8859500000	C.3	FU II 4 R EWS 280V/40kA	8859830000	C.3	
					PU 14 R LCF 280V/20kA	8859500000	C.35	FU II 4 R LCF 280V/20kA	8859790000	C.27	
					PU 14 R LCF 280V/20kA	8859690000	C.25	FU II 4 R LCF 280V/20kA	8859790000	C.3	
					PU 14 R LCF 280V/20kA	8859690000	C.3	FU II O N-PE 260V/40kA	8871940000	C.3	
					PU 14 R LCF 280V/20kA	8859920000	C.31	FU III R 120V/6kV	8860340000	C.4	
					PU 14 R 280V/12,5kA	8860040000	C.3	FU III R 120V/6kV	8860340000	C.45	
					PU 14 R 385V/40kA	8860300000	C.3	FU III R 12V/4kV	8883740000	C.4	
					PU 14 R 385V/40kA	8860300000	C.3	FU III R 12V/4kV	8883740000	C.47	
					PU 14 R 550V/40kA	8860070000	C.3	FU III R 12V/4kV	8883740000	C.47	
					PU 14 R 550V/40kA	8860120000	C.3	FU III R 230V/6kV	8860330000	C.45	
					PU 14 R 550V/40kA	8871950000	C.3	FU III R 230V/6kV	8860330000	C.45	
					PU 14 R EWS 280V/40kA	8859500000	C.3	FU III R 24V/4kV	8860360000	C.46	
					PU 14 R LCF 280V/20kA	8859500000	C.35	FU III R 24V/4kV	8860360000	C.4	
					PU 14 R LCF 280V/20kA	8859690000	C.25	FU III R 48V/4kV	8860350000	C.46	
					PU 14 R LCF 280V/20kA	8859690000	C.3	FU III R 48V/4kV	8860350000	C.2	
					PU 14 R LCF 280V/20kA	8859920000	C.31	FU III R 48V/4kV	8860350000	C.46	
					PU 14 R 280V/12,5kA	8860040000	C.3	FU R COMBI I-II 4 Wire	8729970000	C.20	
					PU 14 R 385V/40kA	8860300000	C.3	FU R COMBI I-II 4 Wire	8729970000	C.20	
					PU 14 R 385V/40kA	8860300000	C.3	FU R COMBI I-II 5 Wire	8729930000	C.2	
					PU 14 R 550V/40kA	8860070000	C.3	FU R COMBI I-II 5 Wire	8729930000	C.21	
					PU 14 R 550V/40kA	8860120000	C.3	FU R COMBI I-II 5 Wire	8729930000	C.21	
					PU 14 R EWS 280V/40kA	8871950000	C.3	FV BOX AC DC	8959730000	F.11	
					PU 14 R EWS 280V/40kA	8859500000	C.3	FV BOX AC DC 2	8959740000	F.11	
					PU 14 R LCF 280V/20kA	8859500000	C.35	FV BOX DC	8959710000	F.10	
					PU 14 R LCF 280V/20kA	8859690000	C.25	FV BOX DC 2	8959720000	F.10	
					PU 14 R LCF 280V/20kA	8859690000	C.3	FV BOX Multistring	8959750000	F.12	
					PU 14 R LCF 280V/20kA	8859920000	C.31				
					PU 14 R 280V/12,5kA	8860040000	C.3				
					PU 14 R 385V/40kA	8860300000	C.3				
					PU 14 R 385V/40kA	8860300000	C.3				
					PU 14 R 550V/40kA	8860070000	C.3				
					PU 14 R 550V/40kA	8860120000	C.3				
					PU 14 R 550V/40kA	8871950000	C.3				
					PU 14 R EWS 280V/40kA	8859500000	C.3				
					PU 14 R EWS 280V/40kA	8859500000	C.35				
					PU 14 R LCF 280V/20kA	8859500000	C.3				
					PU 14 R LCF 280V/20kA	8859690000	C.25				
					PU 14 R LCF 280V/20kA	8859690000	C.3				
					PU 14 R LCF 280V/20kA	8859920000	C.31				
					PU 14 R 280V/12,5kA	8860040000	C.3				
					PU 14 R 385V/40kA	8860300000	C.3				
					PU 14 R 385V/40kA	8860300000	C.3				
					PU 14 R 550V/40kA	8860070000	C.3				
					PU 14 R 550V/40kA	8860120000	C.3				
					PU 14 R 550V/40kA	8871950000	C.3				
					PU 14 R EWS 280V/40kA	8859500000	C.3				
					PU 14 R EWS 280V/40kA	8859500000	C.35				
					PU 14 R LCF 280V/20kA	8859500000	C.3				
					PU 14 R LCF 280V/20kA	8859690000	C.25				
					PU 14 R LCF 280V/20kA	8859690000	C.3				
					PU 14 R LCF 280V/20kA	8859920000	C.31				
					PU 14 R 280V/12,5kA	8860040000	C.3				
					PU 14 R 385V/40kA	8860300000	C.3				
					PU 14 R 385V/40kA	8860300000	C.3				
					PU 14 R 550V/40kA	8860070000	C.3				
					PU 14 R 550V/40kA	8860120000	C.3				
					PU 14 R 550V/40kA	8871950000	C.3				
					PU 14 R EWS 280V/40kA	8859500000	C.3				
					PU 14 R EWS 280V/40kA	8859500000	C.35				
					PU 14 R LCF 280V/20kA	8859500000	C.3				
					PU 14 R LCF 280V/20kA	8859690000	C.25				
					PU 14 R LCF 280V/20kA	8859690000	C.3				
					PU 14 R LCF 280V/20kA	8859920000	C.31				
					PU 14 R 280V/12,5kA	8860040000	C.3				
					PU 14 R 385V/40kA	8860300000	C.3				
					PU 14 R 385V/40kA	8860300000	C.3				
					PU 14 R 550V/40kA	8860070000	C.3				
					PU 14 R 550V/40kA	8860120000	C.3				
					PU 14 R 550V/40kA	8871950000	C.3				
					PU 14 R EWS 280V/40kA	8859500000	C.3				
					PU 14 R EWS 280V/40kA	8859500000	C.35				
					PU 14 R LCF 280V/20kA						

Type	Order No.	Page	Type	Order No.	Page	Type	Order No.	Page	Type	Order No.	Page
QB 2 WI RA6 IS	0482700000	D.26	VSPC 2CL HF 12VDC	8924460000	B.13	VSSC4 CL 60Vuc 0.5A	1063750000	B.73	WAVEFILTER 3A	8614780000	C.58
QB 2 WI RA6 IS	0482700000	D.27	VSPC 2CL HF 12VDC R	8924510000	B.13	VSSC4 CL FG 12Vdc 0.5A	1063760000	B.73	WAVEFILTER 6A	8614800000	C.59
QB 3 WI RA6 IS	0482900000	D.26	VSPC 2CL HF 24VDC	8924510000	B.13	VSSC4 CL FG 24Vuc 0.5A	1063770000	B.73	WAVEFILTER 10A	8614770000	C.59
QB 3 WI RA6 IS	0482900000	D.27	VSPC 2CL HF 24VDC R	8951700000	B.13	VSSC4 CL FG 48Vuc 0.5A	1063780000	B.73	WDK 2.5 RC 220R/220NF	8065910000	D.26
QB 36 1-1 FU BC / BCR	8858350000	C.10	VSPC 2CL HF 5VDC	8924430000	B.13	VSSC4 CL FG 60Vuc 0.5A	1063790000	B.73	WDK 2.5 U TAZ 24VAC	8132760000	D.25
QB 36 3-1 FU BC	8858360000	C.10	VSPC 2CL HF 5VDC R	8951680000	B.13	VSSC4 GDT 110Vuc 20kA	1064050000	B.79	WPG 4	1036000000	D.27
QB 36-3	8816090000	C.10	VSPC 2SL 12VAC	8924250000	B.17	VSSC4 GDT 240VUC 20KA	1064060000	B.79			
QB 36-4	8816100000	C.10	VSPC 2SL 12VAC EX	8953630000	B.43	VSSC4 MOV 120Vuc	1063990000	B.77			
QB 4 WI RA6 IS	0482900000	D.26	VSPC 2SL 12VDC	8924230000	B.17	VSSC4 MOV 120Vdc	1063950000	B.77			
QB 4 WI RA6 IS	0482900000	D.27	VSPC 2SL 12VDC EX	8953620000	B.43	VSSC4 MOV 150Vuc	1064010000	B.77	ZR WPG4 DB	1071100000	D.27
QB 54 3-1 FU BCR	8858340000	C.10	VSPC 2SL 12VDC R	8951620000	B.17	VSSC4 MOV 240VUC	1064020000	B.77			
QB 54-3	8821720000	C.10	VSPC 2SL 24VAC	8924330000	B.17	VSSC4 MOV 24Vuc	1063960000	B.77			
QB 54-4	8821710000	C.10	VSPC 2SL 24VAC R	8951640000	B.17	VSSC4 MOV 48Vuc	1063970000	B.77			
QB 75/6,2/9WI	0526400000	D.26	VSPC 2SL 24VDC	8924330000	B.17	VSSC4 MOV 60Vuc	1063980000	B.77			
QB 75/6,2/9WI	0526400000	D.27	VSPC 2SL 24VDC EX	8953670000	B.43	VSSC4 RC 240Vuc	1064130000	B.81			
			VSPC 2SL 24VDC R	8951630000	B.17	VSSC4 RC 24Vuc	1064120000	B.81			
			VSPC 2SL 48VAC	8924370000	B.17	VSSC4 SL 12Vdc 0.5A	1063830000	B.75			
			VSPC 2SL 48VAC EX	8953640000	B.43	VSSC4 SL 24Vuc 0.5A	1063840000	B.75			
			VSPC 2SL 5VDC	8924210000	B.17	VSSC4 SL 48Vuc 0.5A	1063860000	B.75			
RS 485 K21 UE-SCHUTZ SE	8008501001	D.2	VSPC 2SL 5VDC R	8951610000	B.17	VSSC4 SL 60Vuc 0.5A	1063870000	B.75			
RS 485 K21 UE-SCHUTZ SE	8008501001	E.5	VSPC 2SL 60VAC	8924390000	B.17	VSSC4 SL FG 12Vdc 0.5A	1063880000	B.75			
RS232-8 S/B25	8570500000	D.2	VSPC 2SL 60VAC EX	8924550000	B.21	VSSC4 SL FG 24Vuc 0.5A	1063890000	B.75			
RS232-8 S/B25	8570510000	D.2	VSPC 3/WIRE 5VDC	8924540000	B.21	VSSC4 SL FG 48Vuc 0.5A	1063910000	B.75			
RS232-8 S/B25	8570510000	E.4	VSPC 3/WIRE 5VDC EX	8953650000	B.47	VSSC4 SL FG 60Vuc 0.5A	1063920000	B.75			
RSU 115VUC 10A	8104221001	D.3	VSPC 4SL 12VAC	8924240000	B.19	VSSC4 TAZ 12Vdc	1064070000	B.79			
RSU 115VUC 10A	8104221001	D.38	VSPC 4SL 12VAC EX	1161150000	B.45	VSSC4 TAZ 24Vuc	1064080000	B.79			
RSU 115VUC 6A	1171561001	D.3	VSPC 4SL 12VDC	8924220000	B.19	VSSC4 TAZ 48Vuc	1064090000	B.79			
RSU 115VUC 6A	1171561001	D.36	VSPC 4SL 12VDC EX	1161170000	B.45	VSSC4 TAZ 60Vuc	1064110000	B.79			
RSU 230VUC 10A LP	8093281001	D.3	VSPC 4SL 12VDC R	8951580000	B.19	VSSC6 CL 24Vuc 0.5A	1064170000	B.49			
RSU 230VUC 10A LP	8093281001	D.39	VSPC 4SL 24VAC	8924340000	B.19	VSSC6 CL 48Vuc 0.5A	1064190000	B.49			
RSU 230VUC 6A LP	1171661001	D.3	VSPC 4SL 24VAC EX	1161180000	B.45	VSSC6 CL FG 12Vdc 0.5A	1064260000	B.51			
RSU 230VUC 6A LP	1171661001	D.37	VSPC 4SL 24VAC R	8951600000	B.19	VSSC6 CL FG 24Vuc 0.5A	1064270000	B.51			
RSU 24VUC 10A	8104201001	D.3	VSPC 4SL 24VDC	8924320000	B.19	VSSC6 CL FG 48Vuc 0.5A	1064280000	B.51			
RSU 24VUC 10A	8104201001	D.38	VSPC 4SL 24VDC EX	1161190000	B.45	VSSC6 CL FG 60Vuc 0.5A	1064290000	B.51			
RSU 24VUC 6A LP	1171361001	D.3	VSPC 4SL 24VDC R	8951590000	B.19	VSSC6 GDT 110Vuc 10kA	1064690000	B.63			
RSU 24VUC 6A LP	1171361001	D.36	VSPC 4SL 48VAC	8924360000	B.19	VSSC6 GDT 110Vuc 20kA	1064700000	B.65			
			VSPC 4SL 5VDC	8924200000	B.19	VSSC6 GDT 240VUC 10KA	1064710000	B.63			
			VSPC 4SL 60VAC	8951570000	B.19	VSSC6 GDT 240VUC 20KA	1064720000	B.65			
			VSPC BASE 1CL	8924380000	B.19	VSSC6 GDT 24Vuc 10kA	1064640000	B.63			
SEG-U LP	8007871001	D.2	VSPC BASE 1CL FG	8924730000	B.8	VSSC6 GDT 24Vuc 20kA	1064670000	B.65			
SEG-U LP	8007871001	D.3	VSPC BASE 1CL FG EX	8924290000	B.8	VSSC6 MOV 120Vuc	1064610000	B.61			
SEG-U LP	8007871001	D.50	VSPC BASE 1CL FG EX	8951810000	B.37	VSSC6 MOV 12Vdc	1064530000	B.57			
SEG-U LP	8007871001	D.51	VSPC BASE 1CL FG R	8951740000	B.8	VSSC6 MOV 150Vuc	1064620000	B.61			
SSCH 7.3X1.2X1000	1071200000	D.27	VSPC BASE 1CL PW	1070230000	B.14	VSSC6 MOV 240VUC	1064630000	B.61			
STB 8.5/D4/2.3/M2.5 AKZ	0215700000	D.26	VSPC BASE 1CL PW FG	1105700000	B.14	VSSC6 MOV 24Vuc	1064540000	B.57			
STB 8.5/D4/2.3/M2.5 AKZ	0215700000	D.27	VSPC BASE 1CL PW FG EX	1070470000	B.41	VSSC6 MOV 48Vuc	1064570000	B.59			
			VSPC BASE 1CL R	8951730000	B.8	VSSC6 MOV 60Vuc	1064600000	B.59			
			VSPC BASE 2/4CH	8924740000	B.26	VSSC6 RS232	1064990000	B.69			
			VSPC BASE 2/4CH	8924740000	B.24	VSSC6 RS485	1064980000	B.69			
TAE OVP analog	8673960000	D.3	VSPC BASE 2/4CH	8924740000	B.22	VSSC6 RS485 DP	1065010000	B.69			
TAE OVP analog	8673960000	E.13	VSPC BASE 2/4CH	8924740000	B.20	VSSC6 SLFG LD12Vdc0.5A	1064420000	B.55			
TAE ovp analog FM	8649910000	D.3	VSPC BASE 2/4CH FG	8924300000	B.26	VSSC6 SLFG LD24Vuc0.5A	1064430000	B.55			
TAE ovp analog FM	8649910000	E.13	VSPC BASE 2/4CH FG	8924300000	B.24	VSSC6 SLFG LD48Vuc0.5A	1064440000	B.55			
TAE OVP analog LED	8674020000	D.3	VSPC BASE 2/4CH FG	8924300000	B.22	VSSC6 SLFG LD60Vuc0.5A	1064470000	B.55			
TAE OVP analog LED	8674020000	E.13	VSPC BASE 2/4CH FG	8924300000	B.20	VSSC6 TAZ 12Vdc	1064730000	B.67			
TAE OVP ISDN	8674000000	D.3	VSPC BASE 2/4CH FG R	8951800000	B.30	VSSC6 TAZ 24Vuc	1064740000	B.67			
TAE OVP ISDN	8674000000	E.14	VSPC BASE 2/4CH FG R	8951800000	B.24	VSSC6 TAZ 48Vuc	1064770000	B.67			
TAE OVP ISDN FM	8673970000	D.3	VSPC BASE 2/4CH R	8951790000	B.30	VSSC6 TAZ 60Vuc	1064790000	B.67			
TAE OVP ISDN FM	8673970000	E.14	VSPC BASE 2/4CH R	8951790000	B.24	VSSC6 CL 12Vdc 0.5A	1064150000	B.49			
TAE OVP ISDN LED	8674010000	D.3	VSPC BASE 2CL	8924710000	B.30	VSSC6 CL 60Vuc 0.5A	1064210000	B.49			
TAE OVP ISDN LED	8674010000	E.14	VSPC BASE 2CL	8924710000	B.28	VSSC6 RTD	1139710000	B.71			
TS 32X15 2M/ST/ZN	0122900000	D.26	VSPC BASE 2CL	8924710000	B.12	VSSC6 SL LD 12Vdc 0.5A	1064340000	B.53			
TS 32X15 2M/ST/ZN	0122900000	D.27	VSPC BASE 2CL	8924710000	B.10	VSSC6 SL LD 24Vuc 0.5A	1064350000	B.53			
TS 35X7.5 2M/ST/ZN	0383400000	D.26	VSPC BASE 2CL FG	8924270000	B.30	VSSC6 SL LD 48Vuc 0.5A	1064360000	B.53			
TS 35X7.5 2M/ST/ZN	0383400000	D.27	VSPC BASE 2CL FG	8924270000	B.28	VSSC6 SL LD 60Vuc 0.5A	1064370000	B.53			
TSCH 4 AK24	0363360000	D.26	VSPC BASE 2CL FG	8924270000	B.12	VSSC6 TR CL 12Vdc 0.5A	1064220000	B.49			
TSCH 4 AK24	0363360000	D.27	VSPC BASE 2CL FG	8924270000	B.10	VSSC6 TR CL 24Vuc 0.5A	1064230000	B.49			
			VSPC BASE 2CL FG R	8951720000	B.12	VSSC6 TR CL 48Vuc 0.5A	1064240000	B.49			
			VSPC BASE 2CL FG R	8951720000	B.10	VSSC6 TR CL 60Vuc 0.5A	1064250000	B.49			
			VSPC BASE 2CL FG EX	8951820000	B.39	VSSC6 TR CLFG 12Vdc0.5A	1064300000	B.51			
UHF Connector / M-F	8947850000	E.9	VSPC BASE 2CL R	8951710000	B.12	VSSC6 TR CLFG 24Vuc0.5A	1064310000	B.51			
			VSPC BASE 2CL R	8951710000	B.10	VSSC6 TR CLFG 48Vuc0.5A	1064320000	B.51			
			VSPC BASE 2SL	8924720000	B.16	VSSC6 TR CLFG 60Vuc0.5A	1064330000	B.51			
			VSPC BASE 2SL FG	8924280000	B.16	VSSC6 TR GDT 240VUC10KA	1064920000	B.63			
			VSPC BASE 2SL FG EX	8951830000	B.43	VSSC6 TR GDT 24Vuc 10kA	1064870000	B.63			
VSPC 1CL 12VDC	8924450000	B.9	VSPC BASE 2SL FG R	8951780000	B.16	VSSC6 TR MOV 120Vuc	1064840000	B.61			
VSPC 1CL 12VDC EX	8953590000	B.37	VSPC BASE 2SL R	8951770000	B.16	VSSC6 TR MOV 12Vdc	1064800000	B.57			
VSPC 1CL 12VDC R	8951540000	B.9	VSPC BASE 4SL	8924700000	B.18	VSSC6 TR MOV 150Vuc	1064850000	B.61			
VSPC 1CL 24VAC	8924500000	B.9	VSPC BASE 4SL FG	8924290000	B.18	VSSC6 TR MOV 240VUC	1064860000	B.61			
VSPC 1CL 24VAC R	8951560000	B.9	VSPC BASE 4SL FG EX	8951840000	B.47	VSSC6 TR MOV 24Vuc	1064810000	B.57			
VSPC 1CL 24VDC	8924460000	B.9	VSPC BASE 4SL FG R	8953800000	B.37	VSSC6 TR MOV 48Vuc	1064820000	B.59			
VSPC 1CL 24VDC EX	8951550000	B.9	VSPC BASE 4SL FG R	8951760000	B.18	VSSC6 TR MOV 60Vuc	1064830000	B.59			
VSPC 1CL 24VDC R	8924520000	B.9	VSPC BASE 4SL R	8951750000	B.18	VSSC6 TR SL FG LD 12Vdc	1064400000	B.55			
VSPC 1CL 48VAC	8924420000	B.9	VSPC CONTROL UNIT 24VDC	8972270000	B.32	VSSC6 TR SL FG LD 24Vuc	1064500000	B.55			
VSPC 1CL 5VDC	8953660000	B.37	VSPC GDT 2CH 150Vuc/230Vdc	8924590000	B.23	VSSC6 TR SL FG LD 48Vuc	1064510000	B.55			
VSPC 1CL 5VDC EX	8951530000	B.9	VSPC GDT 2CH 90V	8924570000	B.23	VSSC6 TR SL FG LD 60Vuc	1064520000	B.55			

Order No.	Type	Page	Order No.	Type	Page	Order No.	Type	Page	Order No.	Type	Page
<b>0050000000</b>			<b>0690000000</b>			<b>8010000000</b>			<b>8010000000</b>		
0053160000 DK 4/35 RC 220R/220N	D.26		0692160000 DK 4/32 RC 220R/220NF	D.26		8015800000 DKU 32 24VDC In0,22A	D.2		8015800000 DKU 32 24VDC In0,22A	D.49	
0059160000 DK 4/35 1D 22R1 +RAHMEN	D.27					8015810000 DKU 35 24VDC In0,22A	D.20		8015810000 DKU 35 24VDC In0,22A	D.20	
<b>0120000000</b>			<b>1030000000</b>			8015810000 DKU 35 24VDC In0,22A	D.49		8015810000 DKU 35 24VDC In0,22A	D.49	
0122280000 TS 32X15 2M/ST/ZN	D.26		1036000000 WPO 4	D.27		8016960000 DK 4Q/35 U TAZ 24VDC	D.25		8016960000 DK 4Q/35 U TAZ 24VDC	D.25	
0122800000 TS 32X15 2M/ST/ZN	D.27		<b>1060000000</b>			8017020000 DK 4Q/35 U TAZ 230VUC	D.25		8017020000 DK 4Q/35 U TAZ 230VUC	D.25	
<b>0180000000</b>			1063720000 VSSC4 CL 12Vdc 0.5A	B.73		8019280000 DKU 32 48VUC In0,22A	D.49		8019280000 DKU 32 48VUC In0,22A	D.49	
0180400000 PS 2.3 RT	D.26		1063730000 VSSC4 CL 24Vuc 0.5A	B.73		8019290000 DKU 35 48VUC In0,22A	D.49		8019290000 DKU 35 48VUC In0,22A	D.49	
0180400000 PS 2.3 RT	D.27		1063740000 VSSC4 CL 48Vuc 0.5A	B.73		8019310000 DKU 35 115VUC 0,3A	D.21		8019310000 DKU 35 115VUC 0,3A	D.21	
<b>0200000000</b>			1063750000 VSSC4 CL 60Vuc 0.5A	B.73		8019330000 DKU 35 230VUC 0,3A	D.2		8019330000 DKU 35 230VUC 0,3A	D.2	
0206160000 EWK 1	D.26		1063760000 VSSC4 CL FG 12Vdc 0.5A	B.73		8019330000 DKU 35 230VUC 0,3A	D.21		8019330000 DKU 35 230VUC 0,3A	D.21	
0206160000 EWK 1	D.27		1063770000 VSSC4 CL FG 24Vuc 0.5A	B.73							
<b>0210000000</b>			1063780000 VSSC4 CL FG 48Vuc 0.5A	B.73							
0215700000 STB 8.5/D4/2.3/M2.5 AKZ	D.26		1063790000 VSSC4 CL FG 60Vuc 0.5A	B.73							
0215700000 STB 8.5/D4/2.3/M2.5 AKZ	D.27		1063830000 VSSC4 SL 12Vdc 0.5A	B.75							
<b>0220000000</b>			1063840000 VSSC4 SL 24Vuc 0.5A	B.75							
0223060000 EGU2 EG2 EN 24VDC 50MA	D.29		1063860000 VSSC4 SL 48Vuc 0.5A	B.75							
0223260000 EGU2 EG2 EN 230VAC 50MA	D.29		1063870000 VSSC4 SL 60Vuc 0.5A	B.75							
<b>0240000000</b>			1063880000 VSSC4 SL FG 12Vdc 0.5A	B.75							
0243960000 EGU1 EG2 EN 24VAC 50MA	D.29		1063890000 VSSC4 SL FG 24Vuc 0.5A	B.75							
<b>0250000000</b>			1063910000 VSSC4 SL FG 48Vuc 0.5A	B.75							
0250560000 EGU3 EG3 24VAC 50MA	D.30		1063920000 VSSC4 SL FG 60Vuc 0.5A	B.75							
0250860000 EGU3 EG3 48VAC 50MA	D.30		1063950000 VSSC4 MOV 12Vdc	B.77							
0250860000 EGU3 EG3 230VAC 50MA	D.30		1063960000 VSSC4 MOV 24Vuc	B.77							
<b>0300000000</b>			1063970000 VSSC4 MOV 48Vuc	B.77							
0303300000 BFSC M2.5X18 PA/RT	D.26		1063980000 VSSC4 MOV 60Vuc	B.77							
0303300000 BFSC M2.5X18 PA/RT	D.27		1063990000 VSSC4 MOV 120Vuc	B.77							
0303400000 AB 4 AKZ4	D.27		1064010000 VSSC4 MOV 150Vuc	B.77							
<b>0330000000</b>			1064020000 VSSC4 MOV 240VUC	B.77							
0336500000 Q 3 AKZ4	D.27		1064030000 VSSC4 GDT 110Vuc 10kA	B.79							
0336600000 Q 4 AKZ4	D.26		1064060000 VSSC4 GDT 240VUC 20kA	B.79							
0336600000 Q 4 AKZ4	D.27		1064070000 VSSC4 TAZ 12Vdc	B.79							
<b>0350000000</b>			1064080000 VSSC4 TAZ 24Vuc	B.79							
0359260000 AP DK4	D.26		1064090000 VSSC4 TAZ 48Vuc	B.79							
0359260000 AP DK4	D.27		1064110000 VSSC4 TAZ 60Vuc	B.81							
0359260000 AP DK4	D.52		1064120000 VSSC4 RC 24Vuc	B.81							
<b>0360000000</b>			1064130000 VSSC4 RC 240Vuc	B.81							
0363360000 TSCH 4 AKZ4	D.26		1064150000 VSSC6 CL 12Vdc 0.5A	B.49							
0363360000 TSCH 4 AKZ4	D.27		1064170000 VSSC6 CL 24Vuc 0.5A	B.49							
0369600000 Q 10 AKZ4	D.27		1064170000 VSSC6 CL 48Vuc 0.5A	B.49							
0369600000 Q 10 AKZ4	D.27		1064210000 VSSC6 CL 60Vuc 0.5A	B.49							
<b>0380000000</b>			1064220000 VSSC6 TR CL 12Vdc 0.5A	B.49							
0383400000 TS 35X7.5 2M/ST/ZN	D.26		1064230000 VSSC6 TR CL 24Vuc 0.5A	B.49							
0383400000 TS 35X7.5 2M/ST/ZN	D.27		1064240000 VSSC6 TR CL 48Vuc 0.5A	B.49							
0383560000 EW 35	D.26		1064250000 VSSC6 TR CL 60Vuc 0.5A	B.49							
0383560000 EW 35	D.27		1064260000 VSSC6 CL FG 12Vdc 0.5A	B.51							
<b>0450000000</b>			1064270000 VSSC6 CL FG 24Vuc 0.5A	B.51							
0459460000 EGU4 EG3 24VDC 0,1A	D.30		1064280000 VSSC6 CL FG 48Vuc 0.5A	B.51							
<b>0460000000</b>			1064290000 VSSC6 CL FG 60Vuc 0.5A	B.51							
0461860000 EGU4 EG3 48VUC 0,1A	D.30		1064300000 VSSC6 TR CL FG 12Vdc 0.5A	B.51							
0462060000 EGU4 EG3 230VUC 0,1A	D.30		1064310000 VSSC6 TR CL FG 24Vuc0.5A	B.51							
<b>0480000000</b>			1064320000 VSSC6 TR CL FG 48Vuc0.5A	B.51							
0482700000 QB 2 WI RA6 IS	D.26		1064330000 VSSC6 TR CL FG 60Vuc0.5A	B.51							
0482700000 QB 2 WI RA6 IS	D.27		1064340000 VSSC6 SL LD 12Vdc 0.5A	B.53							
0482800000 QB 3 WI RA6 IS	D.26		1064350000 VSSC6 SL LD 24Vuc 0.5A	B.53							
0482800000 QB 3 WI RA6 IS	D.27		1064360000 VSSC6 SL LD 48Vuc 0.5A	B.53							
0482900000 QB 4 WI RA6 IS	D.26		1064370000 VSSC6 SL LD 60Vuc 0.5A	B.53							
0482900000 QB 4 WI RA6 IS	D.27		1064380000 VSSC6 TR SL LD12Vdc0.5A	B.53							
<b>0520000000</b>			1064390000 VSSC6 TR SL LD24Vuc0.5A	B.53							
0526400000 QB 75/6.2/9/MI	D.26		1064400000 VSSC6 SLFG LD48Vuc0.5A	B.55							
0526400000 QB 75/6.2/9/MI	D.27		1064420000 VSSC6 SLFG LD12Vdc0.5A	B.55							
0526700000 ISPF QB75 SW	D.26		1064430000 VSSC6 SLFG LD24Vuc0.5A	B.55							
0526700000 ISPF QB75 SW	D.27		1064440000 VSSC6 SLFG LD48Vuc0.5A	B.55							
<b>0680000000</b>			1064450000 VSSC6 SLFG LD60Vuc0.5A	B.55							
0687560000 AP DK14 PA	D.49		1064460000 VSSC6 TR SL FG LD 12Vdc	B.55							
			1064510000 VSSC6 TR SL FG LD 24Vuc	B.55							
			1064520000 VSSC6 TR SL FG LD 48Vuc	B.55							
			1064530000 VSSC6 TR SL FG LD 60Vuc	B.57							
			1064540000 VSSC6 MOV 24Vuc	B.57							
			1064570000 VSSC6 MOV 48Vuc	B.59							
			1064600000 VSSC6 MOV 60Vuc	B.59							
			1064610000 VSSC6 MOV 120Vuc	B.61							
			1064620000 VSSC6 MOV 150Vuc	B.61							
			1064630000 VSSC6 MOV 240VUC	B.61							
			1064640000 VSSC6 GDT 24Vuc 10kA	B.63							
			1064670000 VSSC6 GDT 24Vuc 20kA	B.65							
			1064690000 VSSC6 GDT 110Vuc 10kA	B.63							
			1064700000 VSSC6 GDT 110Vuc 20kA	B.65							
			1064710000 VSSC6 GDT 240VUC 10kA	B.63							
			1064720000 VSSC6 GDT 240VUC 20kA	B.65							
			1064730000 VSSC6 TAZ 12Vdc	B.67							
			1064740000 VSSC6 TAZ 24Vuc	B.67							
			1064770000 VSSC6 TAZ 48Vuc	B.67							
			1064790000 VSSC6 TAZ 60Vuc	B.67							
			1064800000 VSSC6 TR MOV 12Vdc	B.57							
			1064810000 VSSC6 TR MOV 24Vuc	B.57							
			1064820000 VSSC6 TR MOV 48Vuc	B.59							
			1064830000 VSSC6 TR MOV 60Vuc	B.59							
			1064840000 VSSC6 TR MOV 120Vuc	B.61							
			1064850000 VSSC6 TR MOV 150Vuc	B.61							
			1064860000 VSSC6 TR MOV 240VUC	B.61							
			1064870000 VSSC6 TR GDT 24Vuc 10kA	B.63							
			1064890000 VSSC6TR GDT 110Vuc10kA	B.63							
			1064920000 VSSC6 TR GDT 240VUC10kA	B.63							





Order No.	Type	Page
8953660000	VSPC 1CL 5VDC EX	B.37
8953670000	VSPC 2SL 24VDC EX	B.43
8953720000	VSPC 2CL 24VDC EX	B.39
8959710000	PV BOX DC	F.10
8959720000	PV BOX DC 2	F.10
8959730000	PV BOX AC DC	F.11
8959740000	PV BOX AC DC 2	F.11
8959750000	PV BOX Multistring	F.12

## 8960000000

8960480000	PU I 1TSG+ 350V 1,5kV	B.87
8960490000	PU I 2TSG+ 350V 1,5kV	B.86
8960500000	PU I 1+1TSG+ 350V 1,5kV	B.87
8960510000	PU I 3+1TSG+ 350V 1,5kV	B.86
8961900000	PU II 2 750V/30kA	B.83

## 8970000000

8972270000	VSPC CONTROL UNIT 24VDC	B.32
8974910000	PU II 1 750V / 30kA	B.83
8974920000	PU II 1 R 750V / 30kA	B.83
8974930000	PU II 2 R 750V / 30kA	B.83
8974940000	PU II 2+1 750V / 30kA	B.84
8974950000	PU II 2+1 R 750V / 30kA	B.84
8974960000	PU II 3 750V / 30kA	B.82
8974970000	PU II 3 R 750V / 30kA	B.82
8974980000	PU II 3+1 750V / 30kA	B.84
8974990000	PU II 3+1 R 750V / 30kA	B.84
8975000000	PU II 4 750V / 30kA	B.82
8975010000	PU II 4 R 750V / 30kA	B.82

## 9310000000

9310830000	EGU2 EG2 EN 24VDC 1,6A	D.29
9311530000	EGU2 EG2 EN 230VUC 1,6A	D.30

## 9400000000

9400120000	DK 4/35 U 230V 5kA	D.3
9400300000	DK 4/35 U 90V 5kA	D.25
9400400000	DK 4/32 U 90V 20kA	D.25
9400400000	DK 4/32 U 90V 20kA	D.52
9400500000	DK 4/35 U 90V 20kA	D.25
9400500000	DK 4/35 U 90V 20kA	D.52
9400540000	DK 4/35 U 470V 20kA	D.25
9400540000	DK 4/35 U 470V 20kA	D.52
9400550000	DK 4/35 U 600V 20kA	D.25
9401050000	DK 4/32 U S14 K30	D.24
9401120000	DK 4/32 U S14 K130	D.24
9401180000	DK 4/32 U S14 K275	D.24
9401250000	DK 4/32 U S20 K30	D.24
9401380000	DK 4/32 U S20 K275	D.24
9401400000	DK 4/35 U S14 K11	D.24
9401440000	DK 4/35 U S14 K25	D.24
9401450000	DK 4/35 U S14 K30	D.24
9401490000	DK 4/35 U S14 K60	D.24
9401520000	DK 4/35 U S14 K130	D.24
9401590000	DK 4/35 U S14 K300	D.24
9401640000	DK 4/35 U S20 K25	D.24
9401650000	DK 4/35 U S20 K30	D.24
9401780000	DK 4/35 U S20 K275	D.24

## 9450000000

9454930000	LPU RS 485	D.2
9454930000	LPU RS 485	D.3
9454930000	LPU RS 485	E.5









# Addresses worldwide

- AE United Arab Emirates**  
Weidmüller Middle East FZE  
P.O. Box 8591  
SAIF-Zone  
Sharjah – U. A. E.  
Phone +971 6 5527273  
Fax +971 6 5527274  
wme.info@weidmuller.com
- AR Argentina**  
CPI SA  
Bauness 2660  
1431 Buenos Aires  
Phone +54 11 45238008  
Fax +54 11 45220546  
info@cpi.com.ar  
www.cpi.com.ar
- AT Austria**  
Weidmüller GmbH,  
Industriezentrum No Süd  
Straße 2, Objekt M2  
2355 Wiener Neudorf  
Phone +43 2236 6708-0  
Fax +43 2236 6708-199  
office.at@weidmuller.com
- AU Australia**  
Weidmüller Pty. Ltd.  
P.O.Box 6944  
Huntingwood Drive 43  
Huntingwood,  
NSW, 2148  
Phone +61 2 9671-9999  
Fax +61 2 9671-9911  
info@weidmuller.com.au  
www.weidmuller.com.au
- AZ Azerbaijan**  
West Industries Ltd.  
Caspian Plaza, 5-th Floor  
44 J. Jabbarly Str., Baku  
Phone +99412 499 15 15  
Fax +99412 499 14 93  
sales@west-i.com
- BA Bosnia and Herzegovina**  
BH ES ELEKTROSISTEM d.o.o.  
Bul. Vojvode S.  
Stepanovica kod br. 272  
78000 BiH - Banja Luka  
Phone +387 51 420-340  
Fax +387 51 420-341  
eisist@neco.net  
www.elektrosistem.ba
- BE Belgium**  
Weidmüller Benelux B.V.  
Mechelsesteenweg 519 bus 6 en 7  
1930 Nossegem  
Phone +32 2 752 4070  
Fax +32 2 751 3936  
info@weidmuller.be  
www.weidmuller.be
- BG Bulgaria**  
Weid-Bul EOOD  
1756 Sofia  
13, bul. "Kliment Ohridski"  
Phone +359 2 9632560  
Fax +359 2 9631098  
weidbul@nat.bg  
www.weidbul.com
- BH Bahrain**  
Khayber Trading Company  
P.O. Box 1976 Manama,  
Phone +973 720747  
Fax +973 720331  
khayber@bateco.com.bh
- BR Brazil**  
Conexel Conexoes Elétricas Ltda.  
Rua Garcia Lorca, 176  
09695-900, São Paulo SP  
Phone +55 11 43669600  
Fax +55 11 43621677  
vendas@conexel.com.br  
www.conexel.com.br
- BY Belarus**  
TECHNIKON Ltd.  
Okyabrskaya Str. 16/5  
Apt. 704, Minsk 220801  
Phone +375 17 2275830  
Fax +375 17 2275830  
technikon@belsonet.net
- CA Canada**  
W Interconnections CANADA Ltd.  
10 Spy Court, Markham,  
Ontario L3 R5 H6  
Phone +1 905 475-1507  
Phone +1 905 475-2798  
info1@weidmuller.ca  
www.weidmuller.ca
- CH Switzerland**  
Weidmüller Schweiz AG  
Rundbuckstraße 2  
8212 Neuhausen am Rheinfall  
Phone +41 52 6740707  
Fax +41 52 6740708  
info@weidmuller.ch  
www.weidmuller.ch
- CL Chile**  
Felipe Bahamondes S.A./ATS AGRO  
Maria Luisa Santander 0475  
Casilla 3425  
Santiago  
Phone +56 2 341-1271  
Fax +56 2 341-1275  
felipe@atsintech.com
- CN China**  
Weidmüller Interface International  
Trading (Shanghai) Co., Ltd.  
25F, EM Intercontinental Business  
Center,  
100 Yutong Road, Shanghai 200070  
P.R. China  
Phone +86 21 22195008  
Fax +86 21 22195009  
www.cnweidmuller.com
- CO Colombia**  
Automatización Avanzada S. A.  
Carrera 97 No.24c, 23 B4  
4 Bogotá D. C.  
Phone +57 1 5478510  
Fax +57 1 4223044  
comercial@  
automatizacionavanzada.com  
www.automatizacionavanzada.com
- CR Costa Rica**  
ELVATRON S.A.  
la Uruca 400 Norte  
Banco Costa Rica  
San José Costa Rica  
Phone +506 2 961060  
Fax +506 5 200609  
dirk.haase@elvatron.com  
www.elvatron.com
- CZ Czech Republic**  
Weidmüller s. r. o.  
Lomnického 5/1705  
14000 Praha 4  
Phone +420 2 44001400  
Fax +420 2 44001499  
office@weidmuller.cz  
www.weidmuller.cz
- DE Germany**  
Weidmüller GmbH & Co. KG  
P.O. Box 3054  
32720 Detmold  
Ohmstraße 9  
32758 Detmold  
Phone +49 5231 1428-0  
Fax +49 5231 1428-116  
weidmuller@weidmuller.de  
www.weidmuller.de
- DK Denmark**  
Wexoe A/S  
Løjvej 31  
3500 Værløse  
Phone +45 45465800  
Fax +45 45465801  
wexoe@wexoe.dk  
www.wexoe.dk
- EC Ecuador**  
Eisystec S. A. Electricidad  
Sistemas y Tecnología  
Vasco de Contreras N35-25  
y Mañosa, Quito  
Phone +593 2 2456510  
Fax +593 2 2456755  
Eisystec@uio.satnet.net
- EE Estonia**  
Soots Interface OÜ  
Pärnu mnt 142  
11317 Tallinn  
Phone +372 5296177  
Fax +372 6096933  
info@sootsinterface.ee  
www.sootsinterface.ee
- EG Egypt**  
Standard Electric (OMEGA)  
87, Mohamed Farid Street  
Heliopolis, Cairo  
Phone +20 26422977  
Fax +20 26422365  
stdelec@rite.com
- ES Spain**  
Weidmüller S. A.  
Narcis Monturiol 11-13  
Pol. Ind. Sudoeste  
08960 Sant Just Desvern  
Barcelona  
Phone +34 93 4803386  
Fax +34 93 3718055  
weidmuller@weidmuller.es  
www.weidmuller.es
- FI Finland**  
JUHA-ELEKTRO OY  
P. O. Box 57, 641 Helsinki  
Kylvöpolku 6, 680 Helsinki  
Phone +358 10 8328 100  
Fax +358 10 8328 109  
info@juha-elekro.fi  
www.juha-elekro.fi
- FR France**  
Weidmüller E. U. R. L.  
12, Chaussée Jules César  
B.P. 263 Osny  
95523 Cergy Pointoise Cedex  
Phone +33 1 34245500  
Fax +33 1 34245501  
mail@weidmuller.fr
- GB Great Britain**  
Weidmüller Ltd.  
1 Abbey Wood Road  
Kings, West Malling  
ME19 4YT  
Phone +44 1732 877000  
Fax +44 1732 874296  
marketing@weidmuller.co.uk
- GR Greece**  
Electrorama S.A.  
1 An. Martali Str.  
41335 Larissa  
Phone +30 2410 552533188  
Fax +30 2410 283463189  
valizos@electrorama.com.gr
- Greece**  
GA Contact Solutions  
11, Ipokratous Str.  
14452 Metamorfoosi Attika  
Phone +30 210 2823233  
Fax +30 210 2823233  
gasales@gmail.com
- HK Hong Kong**  
United Equity Limited  
Suite B, 11/F International Industrial  
Centre  
2-8 Kwei Tei Street, Fotan, Shatin  
Phone +852 26376739  
Fax +852 26876735  
united\_equity@sinatown.com
- HR Croatia**  
Elektro Partner d.o.o.  
Slavonska Avenija 24/6  
10000 Zagreb  
Phone +385 1 6184793  
Fax +385 1 6184795  
elektropartner@zg.t-com.hr
- HU Hungary**  
Weidmüller Kft  
Gubacsi út 6  
1097 Budapest  
Phone +36 1 3827700  
Fax +36 1 3827701  
info@weidmuller.hu
- ID Indonesia**  
Soots Electrindo  
Ruko Mega Grosir Cempaka Mas,  
Blok I No 20 – 22  
Jl. Let.Jend. Suprato –  
Jakarta 10640  
Phone +62 21 42882255  
Fax +62 21 42882266  
sales@negoelectrindo.co.id
- IE Ireland**  
Please contact Weidmüller Ltd. in  
Great Britain
- IL Israel**  
A.U.Shay Ltd.  
P.O. Box 10049  
Embar Street 23/25  
Petch-Tikva 49222  
Phone +972 3 9233601  
Fax +972 3 9234601
- Israel**  
ATEKA Ltd.  
23 Hayetzira St.  
Kiryat Aryeh  
49130 Patach-Tikva, Israel  
Phone +972 3 9392344  
Fax +972 3 9243273  
marketing@ateka.co.il  
www.ateka.co.il
- IN India**  
Weidmüller Electronics India Pvt. Ltd  
Plot # 32, 3rd Floor, North Court  
Lane North Avenue, Opp Jogger's Park  
Kalyani Nagar, Maharastra  
411006 Pune  
Phone +91 9049800960  
Nitesh.Rajan@weidmuller.de
- IR Iran**  
Tamin Ehtijajat Fani Tehran (TAF Co.)  
72, Iranshahr Ave.(Unit # 5)  
15816 Tehran  
Phone +98 21 8831-7851  
Fax +98 21 8882-0268  
tafco@safineh.net
- IS Iceland**  
Samey Automation Center  
Lyngas 13, 210 Garoabaer,  
Phone +354 510 5200  
Fax +354 510 5201  
samey@samey.is
- IT Italy**  
Weidmüller S.R.L.  
Via Albert Einstein 4  
20092 Cinisello Balsamo  
Milano  
Phone +39 02 660681  
Fax +39 02 6124945  
weidmuller@weidmuller.it  
www.weidmuller.it
- JO Jordan**  
HORIZONS  
P.O.Box: 330607  
Amman Jordan 11133  
Phone +962 6 4882114  
Fax +962 6 4882115  
horizons@go.com.jo
- JP Japan**  
Nihon Weidmüller Co. Ltd.  
Sphere Tower Tennoz,  
2-2-8 Higashi-Shinagawa,  
Shinagawa-Ku, Tokyo 140-0002  
Phone +81 3 6711-5300  
Fax +81 3 6711-5333  
www.weidmuller.co.jp
- KR Korea**  
Weidmüller Korea Co., Ltd.  
6floor, Sukyoung building, 242-54  
Nonhyun-dong, Kangnam-Gu  
Seoul, Korea  
Zip: 135-830  
Phone +82 2 5160003  
Fax +82 2 5160090  
info@weidmuller.co.kr
- KW Kuwait**  
KANA CONTROLS General  
Trading & Cont. CO. W.L.L.  
Al Fai Industrial Area,  
Plot 28-30, St. 31  
P.O.Box: 25593  
Safat, 13016  
Phone +966-474 1373/4  
Fax +966-474 1537  
info@kanacontrols.com

**LB Lebanon**  
Progress Engineering & Trading Enterprises  
Al Nahr Street  
Beirut  
Phone +961 1 444664  
Fax +961 1 561890  
progress@inco.com.lb

**LT Lithuania**  
ELEKTROS IRANGA  
Tinklu g.29a, 5319 Panevezys  
Phone +370 45582828  
Fax +370 45582727  
info@eiranga.lt

**LU Luxembourg**  
Please contact Weidmüller Benelux B.V. in the Netherlands

**LV Latvia**  
SIA "ABI4"  
56A Daugavgrivas str.  
1007 Riga  
Phone +371 67470999  
Fax +371 67465637  
abl\_4@tvnet.lv

**MD Moldova**  
BERHORD A&D srl  
44, srt. Sarmizegetusa 37/3  
Ofi 414, b-dul Decabal, 3,  
Chisinau, MD 2001  
Phone +373 22 507137  
Fax +373 22 507134  
atiuleanu@berhord.com

**ME Montenegro**  
Please contact  
ES-YU Elektrosistem in Serbia

**MK Macedonia**  
ELEKTRO – SMK doool  
UL III Makedonska brigada b.b.  
1000 Skopje  
Phone +389 22 460 295  
Fax +389 22 460 298  
elektro-smk@telekabel.net.mk

**MT Malta**  
E. S. S., Electrical Supplies & Services Ltd  
104 J. Sciberras Str.  
Hamrun HMR 08  
Phone +356 21 255 777  
Fax +356 21 255 999  
robert@ess.com.mt

**MU Mauritius**  
MUBELO Electrical Ltd  
Office 26, Gateway building,  
St. Jean Road, Quatre Bornes  
Phone +230 498 6410  
Fax +230 467 0969  
richard.mubelo@orange.mu

**MX Mexico**  
W Interconnections, S.A. DE C.V.  
Bldv. Hermanos Serdán No. 698  
Col. San Rafael Oriente  
Puebla, C.P. 72029  
Phone +52 222 22686227  
clientes@weidmuller.com.mx

**MY Malaysia**  
Corneil Plus Technology Sdn Bhd  
No. 43, Jalan PJS 11/22,  
Bandar Sunway, 46150 Petaling Jaya  
Selangor Darul Ehsan  
Phone +60 3 5633 7363  
Fax +60 3 5633 6562  
paul@cptech.com.my  
www.cptech.com.my

**NL Netherlands**  
Weidmüller Benelux B.V.  
Franciscusweg 221  
1216 SE Hilversum  
Postbus 1505  
1200 BM Hilversum  
Phone +31 35 6261261  
Fax +31 35 6232044  
info@weidmuller.nl

**NO Norway**  
Siv. Ing. J. F. Knudtzen A/S  
Billingstadsletta 97  
P.O. Box 160  
1378 Nesbru  
Phone +47 66 983350  
Fax +47 66 980955  
firmapost@jknudtzen.no  
www.jknudtzen.no

**NZ New Zealand**  
Cuthbert S. Steward Limited  
27 Te Funi Street  
POB 38496  
Petone, Wellington  
Phone +64 4 5686156  
Fax +64 4 5686056  
info@weidmuller.de

**OM Oman**  
DAN INTERNATIONAL LLC.  
PO BOX 2901  
111 Seeb  
Phone +968 503 677  
Fax +968 503 755  
yed@danintl.com

**PE Peru**  
TECNOLOGÍA ELÉCTRICA Y SOLUCIONES S.A.C.  
Calle Huandoy 501, Lima 32, Peru  
Phone / Fax +51 1 562-0004  
info@tecsol-peru.com

**Peru**  
IMGEPRO DEL PERU S.A.C.  
Jr. Arcequipa 3410, Lima 31, Peru  
Phone / Fax +51 1 569-7678  
dbernardo@imgepro.com.pe  
www.imgepro.pe

**PH Philippines**  
Enclosure Systems Specialists Inc  
W-15 La Fuerza Compound  
2241 Don Chino Roces Avenue  
Makati City 1231  
Phone +63 2 813 8580  
Fax +63 2 813 8596  
sales\_ency@epkldrd.net

**PK Pakistan**  
Kana Controls (Pak)  
Apartment No. 33 C III  
Chenab Block,  
Allama Iqbal Town  
Lahore, Pakistan  
Phone +92 42 5419948  
+92 42 7845160  
Fax +92 42 5422895  
nadeem@kanapak.com  
www.kanapak.com

**PL Poland**  
Weidmüller Sp. z o.o.  
Ul. Goleczynowska 10  
03-302 Warszawa  
Phone +48 22 5100940  
Fax +48 22 5100941  
biuro@weidmuller.com.pl  
www.weidmuller.pl

**PT Portugal**  
Weidmüller Sistemas de Interface S. A.  
Estrada Outeiro Polima, R. Augusto  
Dias da Silva, Lote B, Esct. 2  
2785-515 Abóboda - São Domingos  
de Rana  
Phone +351 21 4459191  
Fax +351 21 4455871  
www.weidmuller.pt

**QA Qatar**  
Doha Motors Trading Co.  
(Technical Division)  
Post Box No. 145  
Airport Road  
Doha – Qatar  
Phone +974 465 1441  
Fax +974 465 0925  
dmt@tech@qatar.net.qa

**RO Romania**  
Rominterface Impex SRL  
Str. Gh. Dem Teodorescu 30 A  
300916 Bucuresti – sector 3  
Phone +40 21 3220230  
Fax +40 21 3228657  
office@rominterface.ro

**RS Serbia**  
ES-YU Elektrosistem  
Pariške kolone 41  
11070 Novi Beograd, Serbia  
Phone +381 11 3018660  
Fax +381 11 2693608  
esyu@eunet.rs  
www.elektrosistem.co.rs

**RU Russia**  
Weidmüller Interface GmbH & Co. KG  
Representative Office  
Warshavskoye highway, 25A, bld. 6  
117105 Moscow  
Phone +7 4 95 771-6940  
Fax +7 4 95 771-6941  
info@weidmuller.ru  
www.weidmuller.ru

**SA Saudi Arabia**  
Al Abdulkarim Holding Co.  
P.O. Box. 4  
Dammam 31411  
Phone +9668337110  
Fax +9668338242  
salehsk@akh.com.sa  
www.akte.com.sa

Saudi Electric Supply Co.  
P.O. Box 3298  
Al Khobar 31952  
Phone / Fax +966 3 882 9546227  
info@tesco-peru.com

**SE Sweden**  
Weidmüller AB  
Axel Daniéssons väg 271  
P.O. box 31025  
200 48 Malmö  
Phone +46 (0) 7 71 43 00 44  
Fax +46 (0) 40 37 48 60  
info@weidmuller.se  
www.weidmuller.se

**SG Singapore**  
Weidmüller Pte. Ltd.  
70 Bendemeer Road  
#04-03 Luzerne  
Singapore 339940  
Phone +65 6841 5311  
Fax +65 6841 5377  
info@weidmuller.com.sg  
www.weidmuller.com.sg

**SI Slovenia**  
ELEKTROSPOJJI d.o.o.  
Stegne 25, 1000 Ljubljana  
Phone +386 15115610  
Fax +386 1511604  
info@elektrospojji.si  
www.elektrospojji.si

**SK Slovakia**  
ELEKTRIS s.r.o.  
Elektrárnská 1  
83104 Bratislava  
Phone +421 2 49200113  
Fax +421 2 49200119  
weidmuller@computel.sk

**TH Thailand**  
Pisanu Engineering Co., Ltd  
800/43-45 Soi Trakulsuk  
Asoke-dindaeng Road,  
Dindaeng, Bangkok 10400  
Phone +66 2 245 9113  
Fax +66 2 6429220  
jaysasankar@pisanu.co.th  
www.pisanu.co.th

**TN Tunisia**  
Please contact  
Weidmüller E.U.R.L. in France

**TR Turkey**  
Weidmüller Elektronik Ticaret Ltd.  
Sirketi  
Kavack Mah. Orhan Veli Kanik  
Caddesi 9/1  
34810 Beykoz – Istanbul  
Phone +90 216 5371070 (Pbx)  
Fax +90 216 5371077  
info@weidmuller.com.tr  
www.weidmuller.com.tr

**TW Taiwan**  
Fittatek Co., Ltd.  
12F No. 185 Fu-Kuo Road,  
Tso Ying Dist, Kaohsiung  
Phone +886 7 556 0858  
Fax +886 7 556 3279  
stanley@fittatek.com.tw  
www.fittatek.com.tw

**Taiwan**  
Eucan Enterprise Ltd.  
No. 145 He Ping 2nd Rd  
Kaohsiung  
Phone +886 7 715 6610  
Fax +886 7 715 8748  
mark@eucan.com.tw  
www.eucan.com.tw

Group companies **DE**

Agency abroad **DE**

Without own Agency **DE**

Index

We cannot guarantee that there are no mistakes in the publications or software provided by us to the customer for the purpose of making orders. We try our best to quickly correct errors in our printed media.

All orders are based on our general terms of delivery, which can be reviewed on the websites of our group companies where you place your order. On demand we can also send the general terms of delivery to you.



# Product Portfolio

Weidmüller is a leading international provider of solutions for electrical connectivity, transmission and conditioning of power, signal and data in industrial environments. The company with headquarters in Detmold/Germany develops, produces and sells products in the field of electrical connectivity and electronics all over the world.

[www.power-signal-data.com](http://www.power-signal-data.com)

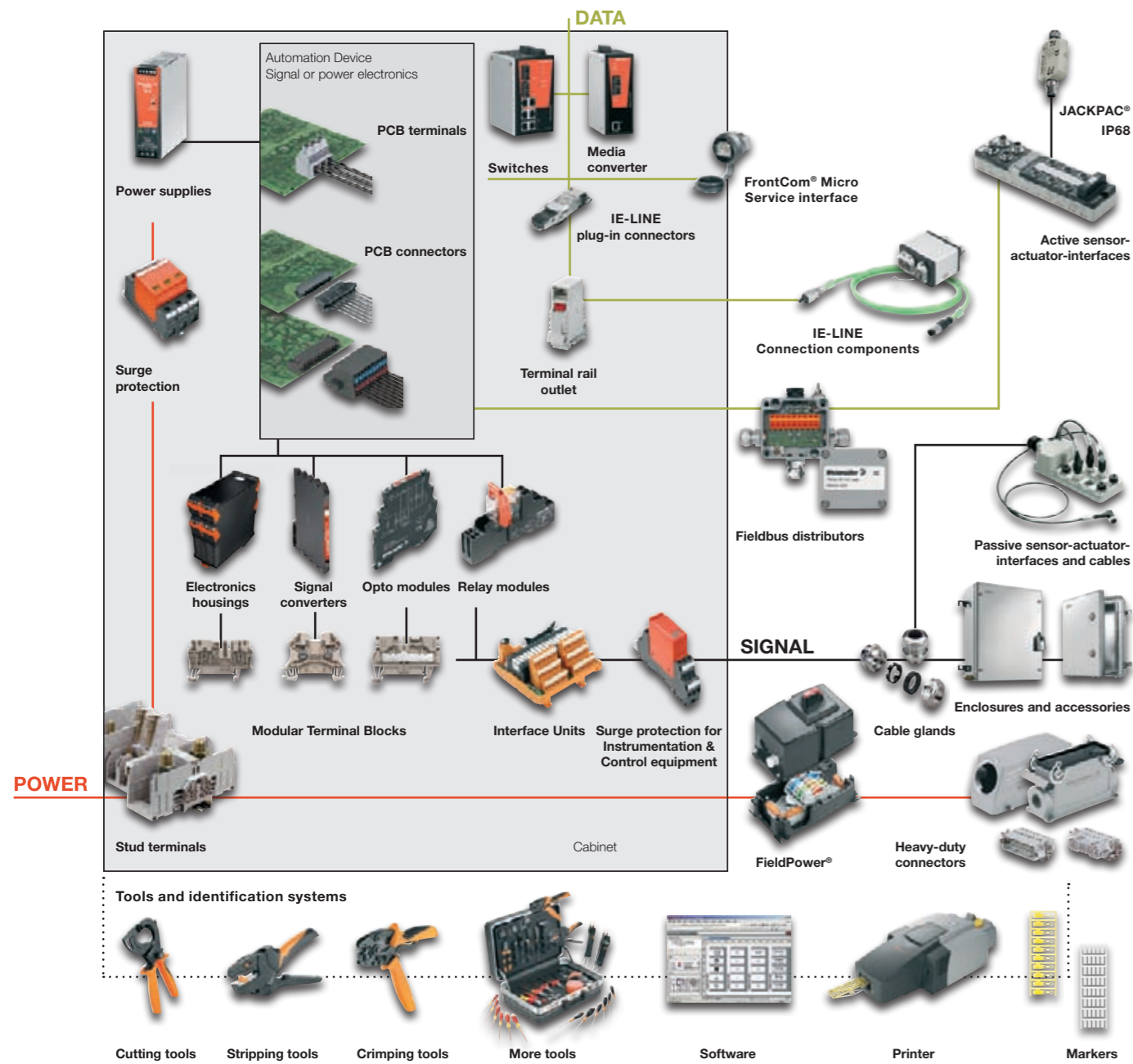

**All the catalogues at a glance**

Catalog	Product	Order No.
Catalog 1	Modular Terminal Blocks	5661400000
Catalog 2	PCB Terminals, PCB Connectors and Housings for Electronics	1000310000
Catalog 3	RockStar® – Heavy Duty Connectors	5664240000
Catalog 4.1	Electronics – Analogue Signal Conditioning	1203510000
Catalog 4.2	Electronics – Relays and Optos	1158120000
Catalog 4.3	Electronics – Power Supplies	1158070000
Catalog 4.4	Electronics – Surge protection	1271290000

Catalog	Product	Order No.
Catalog 4.5	Electronics – Interface units and PLC solutions	1102340000
Catalog 5	Enclosures and Cable Glands	5661920000
Catalog 6	Tools	1161520000
Catalog 7	Identification systems	1125590000
Catalog 8	Sensor Actuator Interface	1235620000
Catalog 9	Industrial Ethernet	1067180000
Product information	FieldPower® – decentralised power distribution	1229860000

# Examples of applications in 230/400 V systems

**TN-C system application**

**TN-C 230/400 V**

**Ordering data**

Class I (B arrester)	Light. protect. class	Type	Order No.	Page	Remarks
Sparkover gap	I / II	3 x PU1 TSG 35 kA/0.9 kV-260 V	8561260000	B.11	No decoupling necessary
or High-power varistor	III / IV	PU I 3 280 V/12.5 kA	8858990000	B.14	No decoupling necessary
Class II (C arrester)	Type	Order No.	Page	Remarks	
Varistor	PU II 3 280 V/40 kA	8859630000	B.22		
Class III (D arrester)	Type	Order No.	Page	Remarks	
Hybrid circuit	PU III 230 V/16 A	8860330000	B.41	Install behind RCD, with FM contact	
or Hybrid circuit	PU D ZS	8697560000	B.48	plugg. for socket outlet with earth. contact	

**TN-C-S system application**

**TN-C-S 230/400 V with 3+1 circuit and TN-S system with 4-pole protection circuit**

**Ordering data**

Class I (B arrester)	Light. protect. class	Type	Order No.	Page	Remarks
Sparkover gap	I / II	3 x PU1 TSG 35 kA/0.9 kV-260 V	8561260000	B.11	No decoupling necessary
	II / III / IV	1 x PU1 TSG 50 kA/0.9 kV-260 V	8561230000	B.11	as N-PE sparkover gap
	III / IV	3 x PU BC	8805440000	B.13	No decoupling necessary
	III / IV	1 x PU1 TSG 50 kA/0.9 kV-260 V	8561230000	B.11	as N-PE sparkover gap
	III / IV	1 x PU1 3 280 V/12.5 kA	8858990000	B.14	No decoupling necessary
	III / IV	1 x PU1 TSG 50 kA/0.9 kV-260 V	8561230000	B.11	as N-PE sparkover gap
Class II (C arrester)	Type	Order No.	Page	Remarks	
Varistor + N-PE	PU II 3+1 280 V/40 kA 3+1 circuit	8859710000	B.24	Inclusive N-PE sparkover gap	
or Varistor	PU II 4 280 V/40 kA	8859640000	B.22	Install behind RCD	
Class III (D arrester)	Type	Order No.	Page	Remarks	
Hybrid circuit	PU III 230 V/16 A	8860330000	B.41	Install behind RCD, with FM contact	
or Hybrid circuit	PU D ZS	8697560000	B.48	plugg. for socket outlet with earth. contact	

**TT system application**

**TT 230/400V with 3+1 circuit**

**Ordering data**

Class I (B arrester)	Light. protect. class	Type	Order No.	Page	Remarks
Sparkover gap	I / II	3 x PU1 TSG 35 kA/0.9 kV-260 V	8561260000	B.11	No decoupling necessary
	III / IV	1 x PU1 TSG 50 kA/0.9 kV-260 V	8561230000	B.11	as N-PE sparkover gap
	III / IV	3 x PU BC	8805440000	B.13	No decoupling necessary
	III / IV	1 x PU1 TSG 50 kA/0.9 kV-260 V	8561230000	B.11	as N-PE sparkover gap
	III / IV	1 x PU1 3 280 V/12.5 kA	8858990000	B.14	No decoupling necessary
	III / IV	1 x PU1 TSG 50 kA/0.9 kV-260 V	8561230000	B.11	as N-PE sparkover gap
Class II (C arrester)	Type	Order No.	Page	Remarks	
Varistor + N-PE	PU II 3+1 280 V/40 kA 3+1 circuit	8859710000	B.24	Inclusive N-PE sparkover gap	
or Varistor	PU II 4 280 V/40 kA	8859640000	B.22	Install behind RCD	
Class III (D arrester)	Type	Order No.	Page	Remarks	
Hybrid circuit	PU III 230 V/16 A	8860330000	B.41	Install behind RCD, with FM contact	
or Hybrid circuit	PU D ZS	8697560000	B.48	plugg. for socket outlet with earth. contact	

**IT system application**

**IT 230/400 V with 3+1 circuit**

**Ordering data**

Class I (B arrester)	Light. protect. class	Type	Order No.	Page	Remarks
Sparkover gap	I / II	3 x PU1 TSG 35 kA/0.9 kV-260 V	8561260000	B.11	No decoupling necessary
	III / IV	3 x PU BC	8805440000	B.13	No decoupling necessary
	III/IV	1x PU1 TSG 50 kA/0.9 kV-260 V	8561230000	B.11	as N-PE sparkover gap
	III/IV	1 x PU1 3 280 V/12.5 kA	8858990000	B.14	No decoupling necessary
	III/IV	1 x PU1 TSG 50 kA/0.9 kV-260 V	8561230000	B.11	as N-PE sparkover gap
	III/IV	1 x PU1 TSG 50 kA/0.9 kV-260 V	8561230000	B.11	as N-PE sparkover gap
Class II (C arrester)	Type	Order No.	Page	Remarks	
Varistor + N-PE	PU III 3+1 280 V/40 kA 3+1 circuit	8859710000	B.24	Inclusive N-PE sparkover gap	
or Varistor	PU II 4 280 V/40 kA	8859640000	B.22	Install behind RCD	
Class III (D arrester)	Type	Order No.	Page	Remarks	
Hybrid circuit	PU III 230 V/16 A	8860330000	B.41	Install behind RCD, with FM contact	
or Hybrid circuit	PU D ZS	8697560000	B.48	plugg. for socket outlet with earth. contact	

For further applications / voltage levels, please ask Weidmüller. All class II arresters and PU BC also available with telecommunication contact.

- |                        |             |                      |
|------------------------|-------------|----------------------|
| Argentina              | Indonesia   | Saudi Arabia         |
| Australia              | Iran        | Serbia               |
| Austria                | Ireland     | Singapore            |
| Azerbaijan             | Israel      | Slovakia             |
| Bahrain                | Italy       | Slovenia             |
| Belarus                | Japan       | South Africa         |
| Belgium                | Jordan      | Spain                |
| Bosnia and Herzegovina | Kazakhstan  | Sweden               |
| Brazil                 | Korea       | Switzerland          |
| Bulgaria               | Kuwait      | Taiwan               |
| Canada                 | Latvia      | Thailand             |
| Chile                  | Lebanon     | Tunisia              |
| China                  | Lithuania   | Turkey               |
| Colombia               | Luxembourg  | Ukraine              |
| Costa Rica             | Macedonia   | United Arab Emirates |
| Croatia                | Malaysia    | United States        |
| Czech Republic         | Malta       | Uruguay              |
| Denmark                | Mexico      | Uzbekistan           |
| Ecuador                | Moldova     | Venezuela            |
| Egypt                  | Netherlands | Vietnam              |
| Estonia                | New Zealand |                      |
| Finland                | Norway      |                      |
| France                 | Oman        |                      |
| Germany                | Pakistan    |                      |
| Great Britain          | Peru        |                      |
| Greece                 | Philippines |                      |
| Hong Kong              | Poland      |                      |
| Hungary                | Portugal    |                      |
| Iceland                | Qatar       |                      |
| India                  | Romania     |                      |
|                        | Russia      |                      |

Weidmüller is a leading international provider of solutions for electrical connectivity, transmission and conditioning of power, signal and data in industrial environments.

The company with headquarters in Detmold/Germany develops, produces and sells products in the field of electrical connectivity and electronics all over the world. Via a network of application specialists Weidmüller offers engineering services and develops application specific solutions.

The complete product and service portfolio consistently assures both Weidmüller and its customers of competitive advantages and an increase in value.

Catalogue 2011

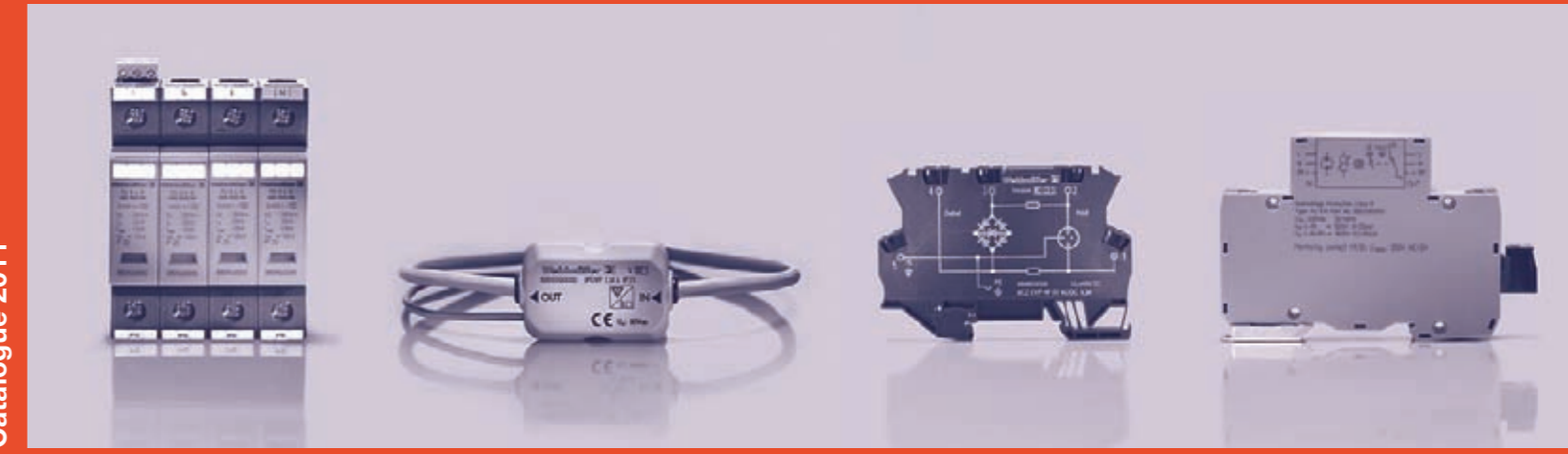

# Electronics Surge protection

Catalogue

Electronics – Surge protection

Order number:  
1271290000/01/2011/SMMD





## X-ON Electronics

Largest Supplier of Electrical and Electronic Components

*Click to view similar products for [weidmuller](#) manufacturer:*

Other Similar products are found below :

[8924550000](#) [56956](#) [0133660000](#) [6720000227](#) [6720005111](#) [68676](#) [69718](#) [EXO24CH](#) [7760056106](#) [7940000218](#) [8005181001](#) [8008180000](#)  
[8432240000](#) [8463580000](#) [8545830000](#) [8689870000](#) [8705640000](#) [9001080000](#) [9003720000](#) [9004250000](#) [9004780000](#) [9013260000](#)  
[9014100000](#) [9019040000](#) [9026010000](#) [9028630000](#) [903708](#) [9037350000](#) [9046290000](#) [9129643500](#) [913155](#) [9159530000](#) [919656](#) [919764](#)  
[9202230000](#) [9202850000](#) [9456750000](#) [9457913000](#) [980811](#) [980826](#) [9912800003](#) [9916080000](#) [9916280012](#) [9918380000](#) [9919371205](#)  
[9919371224](#) [9925710000](#) [9926252005](#) [9927480024](#) [1166660000](#)