

## TRS 24VDC 1CO

**Weidmüller Interface GmbH & Co. KG**

Klingenbergstraße 26

D-32758 Detmold

Germany

www.weidmueller.com

### Product image



- 1 CO contact
- Contact material: AgNi
- Unique multi-voltage input from 24 to 230 V UC
- Input voltages from 5 V DC to 230 V UC with coloured marking: AC: red, DC: blue, UC: white

### General ordering data

Version	TERMSERIES, Relay module, Number of contacts: 1, CO contact AgNi, Rated control voltage: 24 V DC $\pm 20\%$ , Continuous current: 6 A, Screw connection, Test button available: No
Order No.	<a href="#">1122770000</a>
Type	TRS 24VDC 1CO
GTIN (EAN)	4032248904808
Qty.	10 pc(s).

Creation date January 8, 2022 3:47:32 PM CET

Catalogue status 17.12.2021 / We reserve the right to make technical changes.

## TRS 24VDC 1CO

**Weidmüller Interface GmbH & Co. KG**

Klingenbergstraße 26

D-32758 Detmold

Germany

www.weidmueller.com

## Technical data

### Dimensions and weights

Depth	87.8 mm	Depth (inches)	3.457 inch
Height	89.6 mm	Height (inches)	3.528 inch
Width	6.4 mm	Width (inches)	0.252 inch
Net weight	33 g		

### Temperatures

Storage temperature	-40 °C...85 °C	Operating temperature	-40 °C...60 °C
Humidity	5-95% relative humidity, T <sub>u</sub> = 40°C, without condensation		

### Environmental Product Compliance

REACH SVHC	Lead 7439-92-1
------------	----------------

### Rated data UL

Ambient temperature (operational), max. 60 °C		Connection cross-section AWG, min.	AWG 26
Connection cross-section AWG, max.	AWG 14	Type of conductor	rigid copper conductor, flexible copper conductor
Tightening torque, max.	0.4 Nm	Pollution severity level	2

### Control side

Rated control voltage	24 V DC ± 20 %	Rated current DC	11.5 mA
Power rating	280 mW	Pull-in/drop-out voltage, typ.	16 V / 3 V DC
Pull-in/drop-out current, typ.	7.5 mA / 1 mA DC	Status indicator	Green LED
Protective circuit	Free-wheeling diode, Reverse polarity protection	Coil voltage of the replacement relay deviating from the rated control voltage	No
Coil voltage of the replacement relay	24 V DC		

### Load side

Rated switching voltage	250 V AC	Continuous current	6 A
Max. switching frequency at rated load	0.1 Hz	Max. switching voltage, DC	250 V
Min. switching power	1 mA @ 24 V, 10 mA @ 12 V, 100 mA @ 5 V	Inrush current	20 A / 20 ms
AC switching capacity (resistive), max.	1500 VA	DC switching capacity (resistive), max.	144 W @ 24 V
Switch-on delay	≤ 6 ms	Switch-off delay	≤ 15 ms
Contact type	1 CO contact (AgNi)	Mechanical service life	5 x 10 <sup>6</sup> switching cycles

### General data

Operating altitude	≤ 2000 m, above sea level		
Rail	TS 35		
Test button available	No		
Mechanical switch position indicator	No		
Colour	black		
UL94 flammability rating component	Component	Housing	
	UL94 flammability rating	V-0	
	Component	Retaining clip	
	UL94 flammability rating	V-0	

Creation date January 8, 2022 3:47:32 PM CET

Catalogue status 17.12.2021 / We reserve the right to make technical changes.

## TRS 24VDC 1C0

Weidmüller Interface GmbH &amp; Co. KG

Klingenbergstraße 26

D-32758 Detmold

Germany

www.weidmueller.com

## Technical data

## Insulation coordination

Rated voltage	300 V	Pollution severity	2
Surge voltage category	III	Clearance and creepage distances for control side - load side	≥ 6 mm
Dielectric strength for control side - load side	4 kV <sub>eff</sub> / 1 Min.	Dielectric strength of open contact	1 kV <sub>eff</sub> / 1 min
Dielectric strength to mounting rail	4 kV <sub>eff</sub> / 1 Min.	Impulse withstand voltage	6 kV (1.2/50 μs)
Protection degree	IP20		

## Further details of approvals / standards

Standards	EN 50178, EN 55011, EN 61000-6-1, 2, 4	Certificate No. (DNVGL)	TAA00001E5
Certificate no. (cULus)	E141197		

## Connection data

Wire connection method	Screw connection	Stripping length, rated connection	8 mm
Tightening torque, max.	0.4 Nm	Clamping range, rated connection	1.5 mm <sup>2</sup>
Clamping range, min.	0.14 mm <sup>2</sup>	Clamping range, max.	2.5 mm <sup>2</sup>
Wire connection cross section AWG, min.	AWG 26	Wire connection cross section AWG, max.	AWG 14
Wire cross-section, solid, min.	0.14 mm <sup>2</sup>	Wire cross-section, solid, max.	2.5 mm <sup>2</sup>
Wire cross-section, solid, min. (AWG)	AWG 26	Wire cross-section, solid, max. (AWG)	AWG 14
Wire connection cross section, finely stranded, min.	0.14 mm <sup>2</sup>	Wire connection cross section, finely stranded, max.	2.5 mm <sup>2</sup>
Wire cross-section, finely stranded, min. (AWG)	AWG 26	Wire cross-section, finely stranded, max. (AWG)	AWG 14
Wire connection cross-section, finely stranded with wire-end ferrules DIN 46228/4, min.	0.25 mm <sup>2</sup>	Wire connection cross-section, finely stranded with wire-end ferrules DIN 46228/4, max.	2.5 mm <sup>2</sup>
Conductor cross-section, flexible, AEH (DIN 46228-1), min.	0.25 mm <sup>2</sup>	Conductor cross-section, flexible, AEH (DIN 46228-1), max.	2.5 mm <sup>2</sup>
Wire connection cross section, finely stranded, two clampable wires, min.	0.5 mm <sup>2</sup>	Wire cross-section, finely stranded, two clampable wires, max.	1 mm <sup>2</sup>
Twin wire-end ferrules, min.	0.5 mm <sup>2</sup>	Twin wire-end ferrules, max.	1 mm <sup>2</sup>
Blade size	size PH0	Gauge to IEC 60947-1	A1, B1

## Classifications

ETIM 6.0	EC001437	ETIM 7.0	EC001437
ETIM 8.0	EC001437	ECLASS 9.0	27-37-16-01
ECLASS 9.1	27-37-16-01	ECLASS 10.0	27-37-16-01
ECLASS 11.0	27-37-16-01		

## Approvals

Approvals



ROHS	Conform
UL File Number Search	E141197

Creation date January 8, 2022 3:47:32 PM CET

Catalogue status 17.12.2021 / We reserve the right to make technical changes.

**TRS 24VDC 1CO**

**Weidmüller Interface GmbH & Co. KG**  
Klingenbergstraße 26  
D-32758 Detmold  
Germany

[www.weidmueller.com](http://www.weidmueller.com)

**Technical data****Downloads**

Approval/Certificate/Document of Conformity	<a href="#">EU Konformitätserklärung / EU Declaration of Conformity</a>
Engineering Data	<a href="#">CAD data – STEP</a>
Engineering Data	<a href="#">EPLAN, WSCAD, Zuken E3.S</a>
User Documentation	<a href="#">Beipackzettel / Package Insert – multilingual</a>
Catalogues	<a href="#">Catalogues in PDF-format</a>
Brochures	

**TRS 24VDC 1C0**

**Weidmüller Interface GmbH & Co. KG**  
 Klingenbergstraße 26  
 D-32758 Detmold  
 Germany

www.weidmueller.com

**Drawings**

**Wiring diagram**

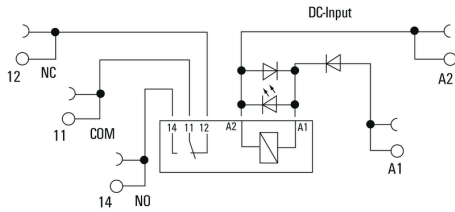

**Graph**

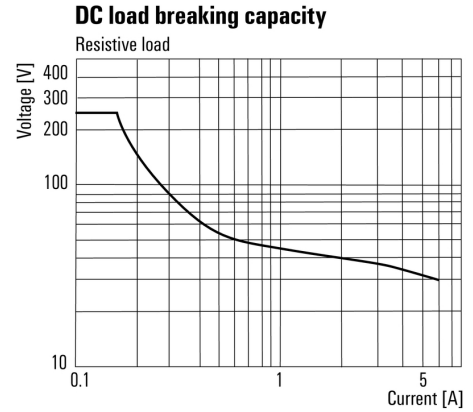

DC load limit curve

**Graph**

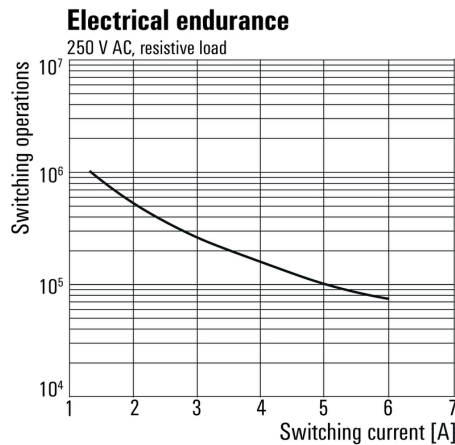

Electrical service life 230 V AC resistive load  
 230 V AC resistive load

**Dimensional drawing**

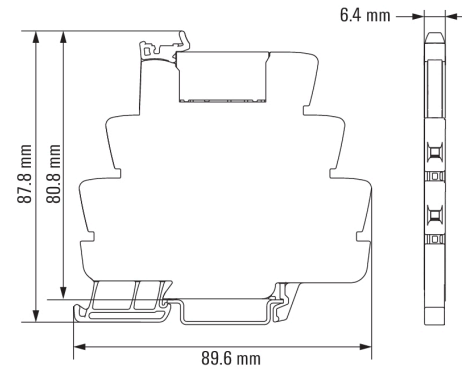

**TRS 24VDC 1C0**

**Weidmüller Interface GmbH & Co. KG**  
 Klingenbergstraße 26  
 D-32758 Detmold  
 Germany

www.weidmueller.com

**Accessories**

**WS 12/6**



**WS/ DEK**

MultiMark terminal markers use an innovative composite material made from two components. The hard base contour of the marker snaps securely into the connector. The elastic surface finish makes the marker easy to mount. This specially punched material enables the strips to be stretched to accommodate the slight variations in spacing that tend to add up, especially with long terminal blocks. Another advantage: the excellent printability of the surface material guarantees durable and wear-resistant labelling. A print resolution of 300 dpi also produces a very legible script.

**Your benefits with MultiMark**

- Firm hold and durable printing
- Continuous strips save installation time
- Easy mounting thanks to an innovative composite material
- Large label field for optimal legibility
- High flexibility thanks to manufacturer independence

**General ordering data**

Type	WS 12/6 MM WS	Version
Order No.	<a href="#">2007200000</a>	WS, Terminal marker, 12 x 6 mm, Weidmueller, white
GTIN (EAN)	4050118391886	
Qty.	600 pc(s).	

**TRS 24VDC 1C0**

**Weidmüller Interface GmbH & Co. KG**  
 Klingenbergstraße 26  
 D-32758 Detmold  
 Germany

www.weidmueller.com

**Accessories**

**Partition plate**



Versatile separation plates  
 Separation plates can be used to group together signals visually, to electrically isolate modules and to insert markings for a better overview. This makes them a particularly versatile accessory. Separation plates increase the clearance and creepage distances between two modules, thus increasing the rated insulation voltage between two modules to up to 600 V. Double separation plates can be marked with WAD5 or WS10/5 markers and enable continuous cross-connections. Installation is made easier with the perforations to individually break out the cross-connection channels.

- Partition plates visually separates groups from each other
- Indentations for individual breaking out the crossconnection channels
- Partition plates isolates between two modules by increasing the clearance and creepage distances of up to 600 V

**General ordering data**

Type	TW TXS/TXZ R3.2	Version	
Order No.	<a href="#">1240800000</a>	TERMSERIES, Partition plate	
GTIN (EAN)	4050118028188		
Qty.	10 pc(s).		

## TRS 24VDC 1C0

**Weidmüller Interface GmbH & Co. KG**  
 Klingenbergstraße 26  
 D-32758 Detmold  
 Germany

www.weidmueller.com

## Accessories

### Cross-connections



#### Adjustable cross-connections

Increase the flexibility of your cross-connections. The TERM SERIES CROSS-CONNECTION (TCC) enables individually adjustable cross-connections with up to 51 poles. The maximum number of pluggable poles has been increased to 32 poles. The strip material can be shortened to the required length very easily. The cross-connectors convince thanks to their easy handling and visibility as well as their universal connection possibilities. An additional web prevents the spring from deforming during assembly.

- Individually adjustable cross-connection with 51 poles
- Additional bar to avoid deformation of the spring
- Increased cross-connection – up to 32 poles possible
- Vibration resistance

### General ordering data

Type	TCC 6.4/2 OR	Version
Order No.	<a href="#">2556350000</a>	TERMSERIES, Cross-connector
GTIN (EAN)	4050118566826	
Qty.	10 pc(s).	
Type	TCC 6.4/10 OR	Version
Order No.	<a href="#">2556360000</a>	TERMSERIES, Cross-connector
GTIN (EAN)	4050118566673	
Qty.	10 pc(s).	
Type	TCC 6.4/51 RD	Version
Order No.	<a href="#">2556410000</a>	TERMSERIES, Cross-connector
GTIN (EAN)	4050118566925	
Qty.	10 pc(s).	
Type	TCC 6.4/51 BL	Version
Order No.	<a href="#">2556450000</a>	TERMSERIES, Cross-connector
GTIN (EAN)	4050118566963	
Qty.	10 pc(s).	
Type	TCC 6.4/2 BK	Version
Order No.	<a href="#">2556470000</a>	TERMSERIES, Cross-connector
GTIN (EAN)	4050118566987	
Qty.	10 pc(s).	
Type	TCC 6.4/10 BK	Version
Order No.	<a href="#">2556480000</a>	TERMSERIES, Cross-connector
GTIN (EAN)	4050118566994	
Qty.	10 pc(s).	
Type	TCC 6.4/10 BL	Version
Order No.	<a href="#">2556440000</a>	TERMSERIES, Cross-connector
GTIN (EAN)	4050118566956	
Qty.	10 pc(s).	
Type	TCC 6.4/2 RD	Version
Order No.	<a href="#">2556390000</a>	TERMSERIES, Cross-connector
GTIN (EAN)	4050118566901	
Qty.	10 pc(s).	



## TRS 24VDC 1C0

**Weidmüller Interface GmbH & Co. KG**  
 Klingenbergstraße 26  
 D-32758 Detmold  
 Germany

www.weidmueller.com

## Accessories

Type	TCC 12.8/26 BL	Version
Order No.	<a href="#">2556460000</a>	TERMSERIES, Cross-connector
GTIN (EAN)	4050118566970	
Qty.	10 pc(s).	
Type	TCC 12.8/26 BK	Version
Order No.	<a href="#">2556500000</a>	TERMSERIES, Cross-connector
GTIN (EAN)	4050118567014	
Qty.	10 pc(s).	
Type	TCC 6.4/2 BL	Version
Order No.	<a href="#">2556430000</a>	TERMSERIES, Cross-connector
GTIN (EAN)	4050118566949	
Qty.	10 pc(s).	
Type	TCC 6.4/51 OR	Version
Order No.	<a href="#">2556370000</a>	TERMSERIES, Cross-connector
GTIN (EAN)	4050118566680	
Qty.	10 pc(s).	
Type	TCC 12.8/26 RD	Version
Order No.	<a href="#">2556420000</a>	TERMSERIES, Cross-connector
GTIN (EAN)	4050118566932	
Qty.	10 pc(s).	
Type	TCC 6.4/10 RD	Version
Order No.	<a href="#">2556400000</a>	TERMSERIES, Cross-connector
GTIN (EAN)	4050118566918	
Qty.	10 pc(s).	
Type	TCC 12.8/26 OR	Version
Order No.	<a href="#">2556380000</a>	TERMSERIES, Cross-connector
GTIN (EAN)	4050118566697	
Qty.	10 pc(s).	
Type	TCC 6.4/51 BK	Version
Order No.	<a href="#">2556490000</a>	TERMSERIES, Cross-connector
GTIN (EAN)	4050118567007	
Qty.	10 pc(s).	

## TRS 24VDC 1C0

Weidmüller Interface GmbH &amp; Co. KG

Klingenbergstraße 26

D-32758 Detmold

Germany

www.weidmueller.com

## Accessories

## Blank



WS markers are the perfect match for the W-series connectors. Thanks to their system compatibility, the WS tags can also be used with the I-series and the Z-series. The large marking surfaces do not only permit long character strings but also multi-line text. WS markers are ideal for labels with long, customised character strings. Thanks to the proven MultiCard format, printing with PrintJet CONNECT oder/or Plotter is possible.

- Can be fitted in strips or individually
- Markers in proven MultiCard format

**For custom printing:** Please send us a file of our labeling software M-Print PRO or M-Print PRO Online (without installation) for your labeling specifications.

## General ordering data

Type	WS 10/6 M MC NE WS	Version
Order No.	<a href="#">181840000</a>	WS, Terminal marker, 10 x 6 mm, Pitch in mm (P): 6.00 Weidmueller,
GTIN (EAN)	4032248310876	Allen-Bradley, white
Qty.	600 pc(s).	

## Interface adapters

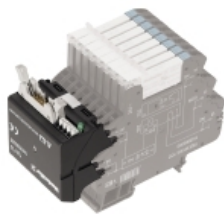

Faster signal wiring with less space

To reduce wiring times, pre-assembled cables are used between the control system and the interface level and are simply connected to the TERM SERIES adapter. This enables throughput times in electrical cabinet building to be significantly reduced. The adapter has a universal fit and offers a genuine space advantage in interaction with the TERM SERIES products with identical contours.

- Reduced wiring time due to plug-and-play concept with pre-assembled cables
- Can be applied to the input and output sides of the TERM SERIES
- Ready for plus and minus switching logic
- High space-saving due to universal fit to other TERM SERIES products

## General ordering data

Type	TIAL F20	Version
Order No.	<a href="#">146355000</a>	TERMSERIES, Adapter, 20-pole plug according to DIN EN 60603-13,
GTIN (EAN)	4050118331783	long locking lever, Number of signal paths: 16, Rated voltage : 24 V
Qty.	1 pc(s).	DC, Rated current (per signal path): 60 mA
Type	TIA F10	Version
Order No.	<a href="#">146352000</a>	TERMSERIES, Adapter, 10-pole plug according to DIN EN 60603-13,
GTIN (EAN)	4050118323535	long locking lever, Number of signal paths: 8, Rated voltage : 24 V DC,
Qty.	1 pc(s).	Rated current (per signal path): 125 mA

## TRS 24VDC 1C0

**Weidmüller Interface GmbH & Co. KG**  
Klingenbergstraße 26  
D-32758 Detmold  
Germany

www.weidmueller.com

## Accessories

Type	TIA SUBD 15S	Version
Order No.	<a href="#">1463530000</a>	TERMSERIES, Adapter, Sub-D, 15-pole, DIN 41652 / IEC 60807,
GTIN (EAN)	4050118323542	Number of signal paths: 8, Rated voltage : 24 V DC, Rated current (per
Qty.	1 pc(s).	signal path): 125 mA

### Slotted screwdriver

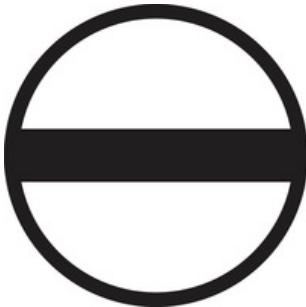

VDE insulated screwdriver sets, for working on live parts up to 1000 V AC and 1500 V DC, DIN EN 60900. IEC 900. Each piece is "GS" safety tested. Blade made from fully hardened, high-alloy chromium-vanadium-molybdenum steel, gun-metal finish.

#### General ordering data

Type	SDIS SLIM 0.6X3.5X100	Version
Order No.	<a href="#">2749610000</a>	Mounting tool, Blade width (B): 3.5 mm, Blade length: 100 mm, Blade
GTIN (EAN)	4050118896350	thickness (A): 0.6 mm
Qty.	1 pc(s).	

### Slotted screwdriver



Slotted screwdriver with rounded blade SD DIN 5265, ISO 2380/2, output to DIN 5264, ISO 2380/1. ChromTop tip, SoftFinish grip

#### General ordering data

Type	SDS 0.6X3.5X100	Version
Order No.	<a href="#">2749340000</a>	Screwdriver, Blade width (B): 3.5 mm, Blade length: 100 mm, Blade
GTIN (EAN)	4050118895568	thickness (A): 0.6 mm
Qty.	1 pc(s).	

**TRS 24VDC 1C0**

**Weidmüller Interface GmbH & Co. KG**  
 Klingenbergstraße 26  
 D-32758 Detmold  
 Germany

www.weidmueller.com

**Accessories**
**Crosshead screwdriver Phillips**

VDE insulated crosshead screwdriver, for Phillips screws, SDIK PH DIN 7438, ISO 8764/2-PH, output to ISO 8764-PH, SoftFinish grip

**General ordering data**

Type	SDIK PH0 X 60	Version
Order No.	<a href="#">2749880000</a>	Screwdriver, Blade length: 60 mm
GTIN (EAN)	4050118897081	
Qty.	1 pc(s).	

**Supply module**

Space-saving supply modules  
 Our supply terminals enable potentials to be fed at the input – e.g. neutral or minus potentials – or switched potentials to be fed at the output. In conjunction with precisely fitting cross-connections from the TEMRSERIES, the connections for the cables on the relay module remain free for actuators or sensors. No additional feed-through terminal blocks are required, resulting in huge space savings in the panel. At the same time, the wiring is simplified as no double wire-end ferrules are required for the potential feed.

**General ordering data**

Type	TXP SUPPLY	Version
Order No.	<a href="#">2618940000</a>	TERMSERIES, Supply module, Number of contacts: 5, , Continuous current: 10 A, PUSH IN
GTIN (EAN)	4050118667592	
Qty.	10 pc(s).	
Type	TXS SUPPLY	Version
Order No.	<a href="#">1240780000</a>	TERMSERIES, Supply module, Number of contacts: 5, , Continuous current: 10 A, Screw connection
GTIN (EAN)	4050118028140	
Qty.	10 pc(s).	
Type	TXZ SUPPLY	Version
Order No.	<a href="#">1240790000</a>	TERMSERIES, Supply module, Number of contacts: 5, , Continuous current: 10 A, Tension-clamp connection
GTIN (EAN)	4050118028164	
Qty.	10 pc(s).	

**Data sheet****TRS 24VDC 1C0**

**Weidmüller Interface GmbH & Co. KG**  
Klingenbergstraße 26  
D-32758 Detmold  
Germany

[www.weidmueller.com](http://www.weidmueller.com)

**Accessories****Crosshead screwdriver Phillips**

Crosshead screwdriver, Phillips, SDK PH DIN 5262, ISO 8764/2-PH, output to ISO 8764-PH, ChromTop tip, SoftFinish grip

**General ordering data**

Type	SDK PH0 X 60	Version
Order No.	<a href="#">2749400000</a>	Screwdriver, Blade length: 60 mm
GTIN (EAN)	4050118895629	
Qty.	1 pc(s).	

TRS 24VDC 1CO

**Weidmüller Interface GmbH & Co. KG**  
 Klingenbergstraße 26  
 D-32758 Detmold  
 Germany

www.weidmueller.com

Drawings

Miscellaneous

**Type code TERMSERIES electromechanical relay versions**

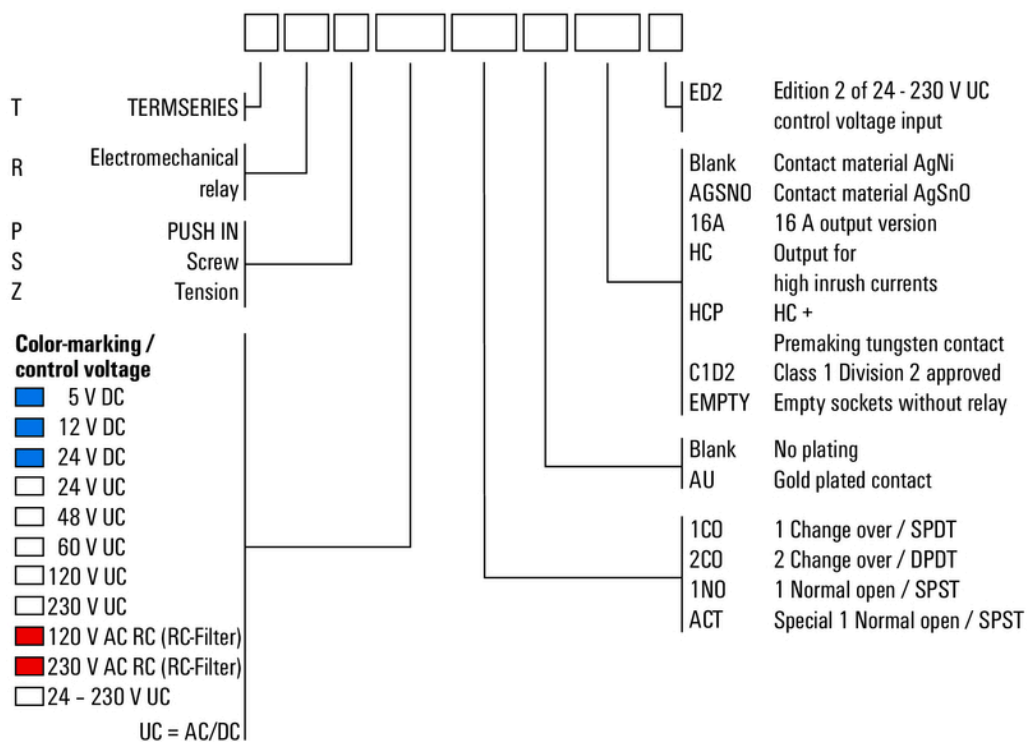

Type codes

## X-ON Electronics

Largest Supplier of Electrical and Electronic Components

*Click to view similar products for [General Purpose Relays](#) category:*

*Click to view products by [Weidmuller](#) manufacturer:*

Other Similar products are found below :

[PCN-105D3MH,000](#) [59641F200](#) [5JO-1000CD-SIL](#) [LY1SAC110120](#) [5X827E](#) [5X837F](#) [5X840F](#) [5X842F](#) [5X848E](#) [LY2N-AC120](#) [LY2S-AC220/240](#) [LY2-US-AC120](#) [LY3-US-AC120](#) [LY4F-UA-DC12](#) [LY4F-UA-DC24](#) [LY4F-US-AC120](#) [LY4F-US-AC240](#) [LY4F-US-DC24](#) [LY4F-VD-AC110](#) [LYQ20DC12](#) [M115C60](#) [M115N010](#) [M115N0150](#) [6031007G](#) [603-12D](#) [61211T0B4](#) [61212T400](#) [61222Q400](#) [61243B600](#) [61243C500](#) [61243Q400](#) [61311BOA2](#) [61311BOA6](#) [61311BOA8](#) [61311C0A2](#) [61311COA1](#) [61311COA6](#) [61311F0A2](#) [61311QOA1](#) [61311QOA4](#) [61311T0D6](#) [61311TOA6](#) [61311TOA7](#) [61311TOB3](#) [61311TOB4](#) [61311U0A6](#) [61312Q600](#) [61312T400](#) [61312T600](#) [61313U200](#)