

## LMF 5.00/17/90 3.5SN OR BX

**Weidmüller Interface GmbH & Co. KG**  
 Klingenbergstraße 26  
 D-32758 Detmold  
 Germany

www.weidmueller.com

### Product image

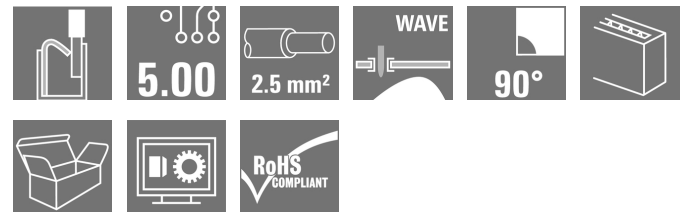
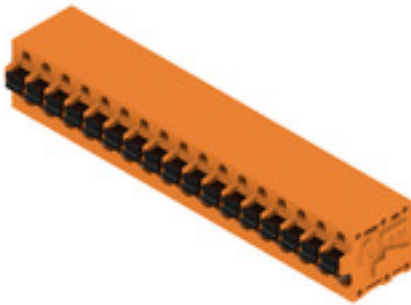

The new LMF allows us to meet the current market requirements for a PCB terminal with PUSH IN connection system for wire cross-sections up to 2.5 mm<sup>2</sup>

- PUSH IN connection system
- LMF with pusher for opening the terminal point
- LMFS without pusher, the terminal point is opened with a screwdriver
- Integrated test point
- 90° and 180° wire outlet direction

### General ordering data

Version	Printed circuit board terminals, 5.00 mm, Number of poles: 17, 90°, Solder pin length (l): 3.5 mm, tinned, orange, PUSH IN with actuator, Clamping range, max. : 2.5 mm <sup>2</sup> , Box
Order No.	<a href="#">1331870000</a>
Type	LMF 5.00/17/90 3.5SN OR BX
GTIN (EAN)	4050118135688
Qty.	15 pc(s).
Product data	IEC: 400 V / 24 A / 0.5 - 2.5 mm <sup>2</sup> UL: 300 V / 20 A / AWG 24 - AWG 12
Packaging	Box

Creation date January 22, 2022 6:04:44 PM CET

## LMF 5.00/17/90 3.5SN OR BX

**Weidmüller Interface GmbH & Co. KG**  
 Klingenbergstraße 26  
 D-32758 Detmold  
 Germany

www.weidmueller.com

## Technical data

## Dimensions and weights

Depth	19.2 mm	Depth (inches)	0.756 inch
Height	18.3 mm	Height (inches)	0.72 inch
Height of lowest version	14.8 mm	Width	87.7 mm
Width (inches)	3.453 inch	Net weight	24.22 g

## System parameters

Product family	OMNIMATE Signal - series LMF	Wire connection method	PUSH IN with actuator
Mounting onto the PCB	THT solder connection	Conductor outlet direction	90°
Pitch in mm (P)	5 mm	Pitch in inches (P)	0.197 inch
Number of poles	17	Pin series quantity	1
Fitted by customer	No	Max. adjacent poles per row	24
Solder pin length (l)	3.5 mm	Solder pin dimensions	d = 0.8 mm, 0.6 x 0.8 mm
Solder eyelet hole diameter (D)	1.1 mm	Solder eyelet hole diameter tolerance (D)+	0, 1 mm
Number of solder pins per pole	2	Screwdriver blade	0.6 x 3.5
Screwdriver blade standard	DIN 5264	Stripping length	10 mm
L1 in mm	80 mm	L1 in inches	3.15 inch
Touch-safe protection acc. to DIN VDE 0470	IP 20	Touch-safe protection acc. to DIN VDE 57 106	Safe from finger touch
Protection degree	IP20		

## Material data

Insulating material	Wemid (PA)	Colour	orange
Colour chart (similar)	RAL 2000	Comparative Tracking Index (CTI)	≥ 600
UL 94 flammability rating	V-0	Contact material	CuSn
Contact surface	tinned	Coating	4-6 µm SN
Tinning type	matt	Layer structure of solder connection	4...6 µm Sn matt
Storage temperature, min.	-40 °C	Storage temperature, max.	70 °C
Operating temperature, min.	-50 °C	Operating temperature, max.	120 °C
Temperature range, installation, min.	-25 °C	Temperature range, installation, max.	120 °C

## Conductors suitable for connection

Clamping range, min.	0.12 mm <sup>2</sup>
Clamping range, max.	2.5 mm <sup>2</sup>
Wire connection cross section AWG, min.	AWG 24
Wire connection cross section AWG, max.	AWG 12
Solid, min. H05(07) V-U	0.5 mm <sup>2</sup>
Solid, max. H05(07) V-U	2.5 mm <sup>2</sup>
Flexible, min. H05(07) V-K	0.25 mm <sup>2</sup>
Flexible, max. H05(07) V-K	2.5 mm <sup>2</sup>
w. plastic collar ferrule, DIN 46228 pt 4, min.	0.25 mm <sup>2</sup>
w. plastic collar ferrule, DIN 46228 pt 4, max.	2.5 mm <sup>2</sup>
w. wire end ferrule, DIN 46228 pt 1, min.	0.25 mm <sup>2</sup>
w. wire end ferrule, DIN 46228 pt 1, max.	2.5 mm <sup>2</sup>
Plug gauge in accordance with EN 60999 a x b; ø	2.4 mm x 1.5 mm

Creation date January 22, 2022 6:04:44 PM CET

## LMF 5.00/17/90 3.5SN OR BX

Weidmüller Interface GmbH &amp; Co. KG

Klingenbergstraße 26

D-32758 Detmold

Germany

www.weidmueller.com

## Technical data

Clampable conductor	Cross-section for conductor connection	Type	fine-wired
		nominal	0.5 mm <sup>2</sup>
wire end ferrule		Stripping length	nominal 12 mm
		Recommended wire-end ferrule	<a href="#">H0.5/16 OR</a>
		Stripping length	nominal 10 mm
		Recommended wire-end ferrule	<a href="#">H0.5/10</a>
Cross-section for conductor connection	Type	fine-wired	
	nominal	0.75 mm <sup>2</sup>	
wire end ferrule		Stripping length	nominal 12 mm
		Recommended wire-end ferrule	<a href="#">H0.75/16 W</a>
		Stripping length	nominal 10 mm
		Recommended wire-end ferrule	<a href="#">H0.75/10</a>
Cross-section for conductor connection	Type	fine-wired	
	nominal	1 mm <sup>2</sup>	
wire end ferrule		Stripping length	nominal 12 mm
		Recommended wire-end ferrule	<a href="#">H1.0/16D R</a>
		Stripping length	nominal 10 mm
		Recommended wire-end ferrule	<a href="#">H1.0/10</a>
Cross-section for conductor connection	Type	fine-wired	
	nominal	1.5 mm <sup>2</sup>	
wire end ferrule		Stripping length	nominal 10 mm
		Recommended wire-end ferrule	<a href="#">H1.5/10</a>
		Stripping length	nominal 12 mm
		Recommended wire-end ferrule	<a href="#">H1.5/16 R</a>
Cross-section for conductor connection	Type	fine-wired	
	nominal	2.5 mm <sup>2</sup>	
wire end ferrule		Stripping length	nominal 10 mm
		Recommended wire-end ferrule	<a href="#">H2.5/10</a>
Reference text	Length of ferrules is to be chosen depending on the product and the rated voltage., The outside diameter of the plastic collar should not be larger than the pitch (P)		

## Rated data acc. to IEC

tested acc. to standard	IEC 60664-1, IEC 61984	Rated current, min. number of poles (Tu=20°C)	24 A
Rated current, max. number of poles (Tu=20°C)	24 A	Rated current, min. number of poles (Tu=40°C)	24 A
Rated current, max. number of poles (Tu=40°C)	24 A	Rated voltage for surge voltage class / pollution degree II/2	400 V
Rated voltage for surge voltage class / pollution degree III/2	320 V	Rated voltage for surge voltage class / pollution degree III/3	250 V
Rated impulse voltage for surge voltage class/ pollution degree II/2	4 kV	Rated impulse voltage for surge voltage class/ pollution degree III/2	4 kV
Rated impulse voltage for surge voltage class/ contamination degree III/3	4 kV	Short-time withstand current resistance	3 x 1s with 120 A

## LMF 5.00/17/90 3.5SN OR BX

Weidmüller Interface GmbH &amp; Co. KG

Klingenbergstraße 26

D-32758 Detmold

Germany

www.weidmueller.com

## Technical data

## Rated data acc. to CSA

Institute (CSA)



Certificate No. (CSA)

20039-1815154

Rated voltage (Use group B / CSA) 300 V

Rated voltage (Use group D / CSA) 300 V

Rated current (Use group B / CSA) 20 A

Rated current (Use group D / CSA) 10 A

Wire cross-section, AWG, min. AWG 24

Wire cross-section, AWG, max. AWG 12

Reference to approval values

Specifications are maximum values, details - see approval certificate.

## Rated data acc. to UL 1059

Institute (cURus)



Certificate No. (cURus)

E60693

Rated voltage (Use group B / UL 1059) 300 V

Rated voltage (Use group D / UL 1059) 300 V

Rated current (Use group B / UL 1059) 20 A

Rated current (Use group D / UL 1059) 10 A

Wire cross-section, AWG, min. AWG 24

Wire cross-section, AWG, max. AWG 12

Reference to approval values

Specifications are maximum values, details - see approval certificate.

## Packing

Packaging	Box	VPE length	338 mm
VPE width	130 mm	VPE height	27 mm

## Classifications

ETIM 6.0	EC002643	ETIM 7.0	EC002643
ETIM 8.0	EC002643	ECLASS 9.0	27-44-04-01
ECLASS 9.1	27-44-04-01	ECLASS 10.0	27-44-04-01
ECLASS 11.0	27-46-01-01		

## LMF 5.00/17/90 3.5SN OR BX

**Weidmüller Interface GmbH & Co. KG**  
 Klingenbergstraße 26  
 D-32758 Detmold  
 Germany

www.weidmueller.com

## Technical data

## Important note

IPC conformity	Conformity: The products are developed, manufactured and delivered according international recognized standards and norms and comply with the assured properties in the data sheet resp. fulfill decorative properties in accordance with IPC-A-610 "Class 2". Further claims on the products can be evaluated on request.
Notes	<ul style="list-style-type: none"> <li>• Additional colours on request</li> <li>• Rated current related to rated cross-section &amp; min. No. of poles.</li> <li>• Wire end ferrule without plastic collar to DIN 46228/1</li> <li>• Wire end ferrule with plastic collar to DIN 46228/4</li> <li>• P on drawing = pitch</li> <li>• Rated data refer only to the component itself. Clearance and creepage distances to other components are to be designed in accordance with the relevant application standards.</li> <li>• The test point can only be used as potential-pickup point.</li> <li>• Long term storage of the product with average temperature of 50 °C and average humidity 70%, 36 months</li> </ul>

## Approvals

Approvals



ROHS	Conform
UL File Number Search	E60693

## Downloads

Approval/Certificate/Document of Conformity	<a href="#">Declaration of the Manufacturer</a>
Engineering Data	<a href="#">CAD data – STEP</a>
Engineering Data	<a href="#">EPLAN, WSCAD</a>
Catalogues	<a href="#">Catalogues in PDF-format</a>
Brochures	<a href="#">FL DRIVES EN</a> <a href="#">FL ANALO.SIGN.CONV. EN</a> <a href="#">MB DEVICE MANUF. EN</a> <a href="#">FL DRIVES DE</a> <a href="#">FL BUILDING SAFETY EN</a> <a href="#">FL APPL LED LIGHTING EN</a> <a href="#">FLIndustr.CONTROLS EN</a> <a href="#">FL MACHINE SAFETY EN</a> <a href="#">FL HEATING ELECTR EN</a> <a href="#">FL APPL INVERTER EN</a> <a href="#">FL_BASE_STATION_EN</a> <a href="#">FL ELEVATOR EN</a> <a href="#">FL POWER SUPPLY EN</a> <a href="#">FL 72H SAMPLE SER EN</a> <a href="#">PO OMNIMATE EN</a> <a href="#">PO OMNIMATE EN</a>

**LMF 5.00/17/90 3.5SN OR BX**

**Weidmüller Interface GmbH & Co. KG**  
 Klingenbergstraße 26  
 D-32758 Detmold  
 Germany

www.weidmueller.com

Drawings

Product image

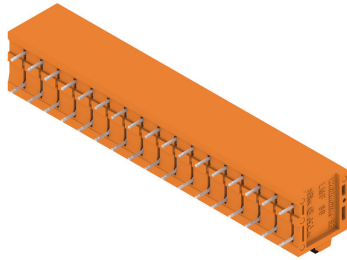

Dimensional drawing

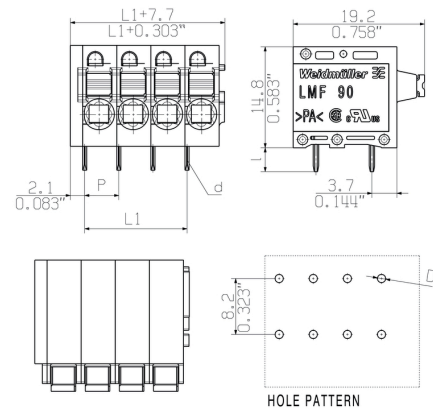

Graph

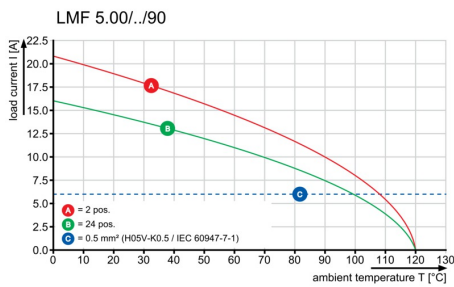

Graph

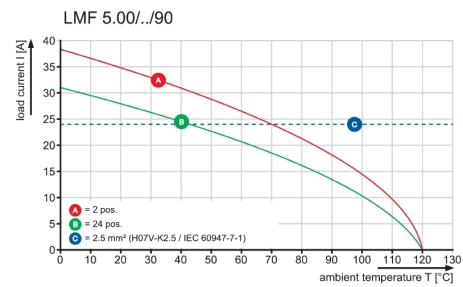

Product benefits

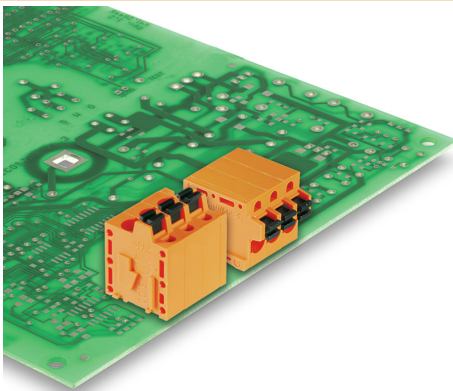

Optional conductor outlet direction  
 Stable mechanical design

Product benefits

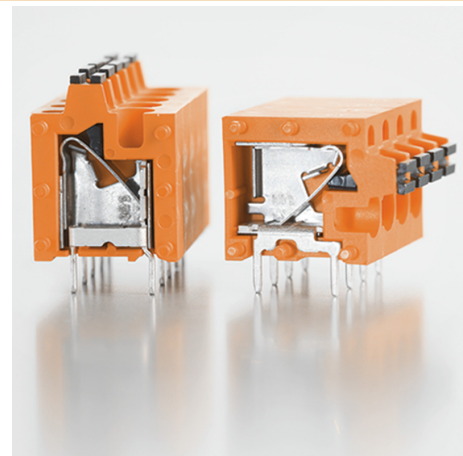

High reliability of the current capacity

## LMF 5.00/17/90 3.5SN OR BX

**Weidmüller Interface GmbH & Co. KG**  
 Klingenbergstraße 26  
 D-32758 Detmold  
 Germany

www.weidmueller.com

## Accessories

### Additional accessories



#### No task is too small when creating the perfect solution.

Connections form just one part of the overall process. Small details are often the key to the perfect solution in applications where potentials are tested, grouped or even isolated.

A system is not a system without small but essential details:

- Test plugs ensure reliable pick-up from diagnostic sockets

In tandem with the manufacturing process and application.

### General ordering data

Type	PS 2.0 MC	Version	Product data	Packaging
Order No.	<a href="#">0310000000</a>	PCB plug-in connector, Accessories, Test plug, red, Number of poles: 1		Box
GTIN (EAN)	4008190000059			
Qty.	20 pc(s).			

### Slotted screwdriver

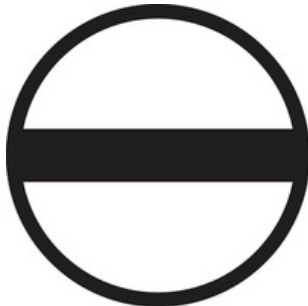

VDE insulated slot-head screwdriver, SDI DIN 7437, ISO 2380/2, drive output acc. to DIN 5264, ISO 2380/1. SoftFinish grip

### General ordering data

Type	SDIS 0.6X3.5X100	Version
Order No.	<a href="#">9008390000</a>	Screwdriver, Screwdriver
GTIN (EAN)	4032248056354	
Qty.	1 pc(s).	

**LMF 5.00/17/90 3.5SN OR BX**

**Weidmüller Interface GmbH & Co. KG**  
Klingenbergstraße 26  
D-32758 Detmold  
Germany

[www.weidmueller.com](http://www.weidmueller.com)

Drawings

Product benefits

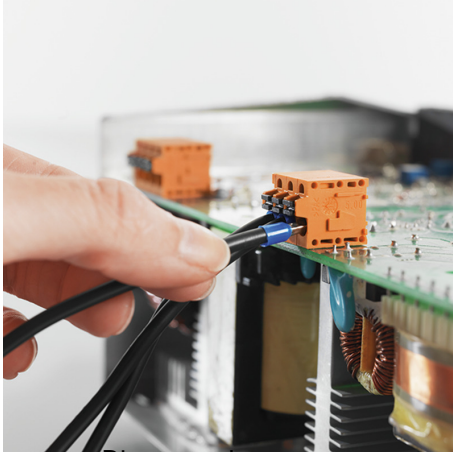

Direct conductor entry  
Cross section up to 2.5 mm<sup>2</sup>

Product benefits

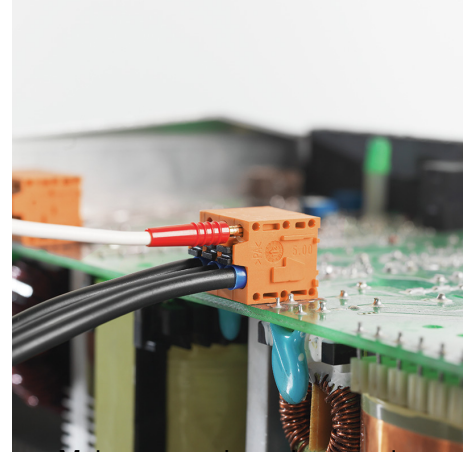

Maintenance through test point



MASSE OHNE TOLERANZ SIND KEINE PRUEFFMASSE  
 DIMS. WITHOUT TOLERANCE ARE NOT CONTROL DIMS.

SHOWN: LMF 5.00/04/90 3.5

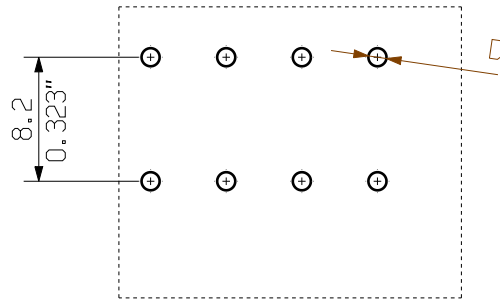
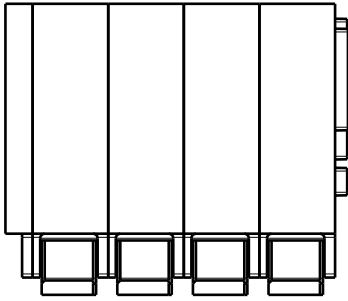
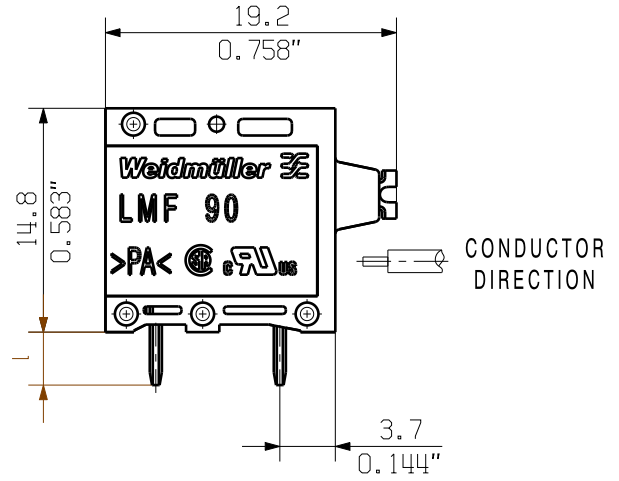
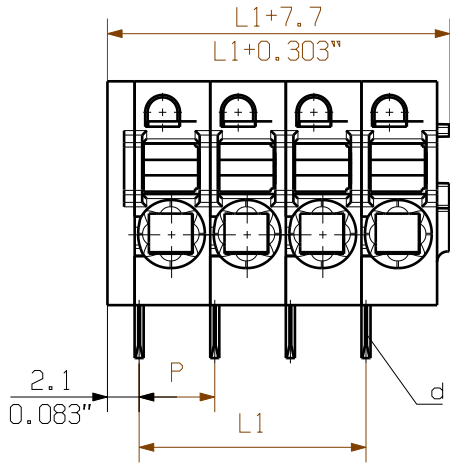

HOLE PATTERN



SHOWN: LMFS 5.00/04/90 3.5

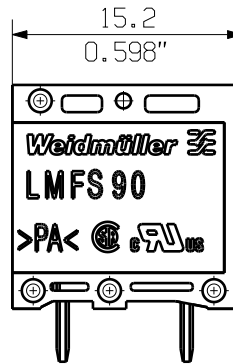
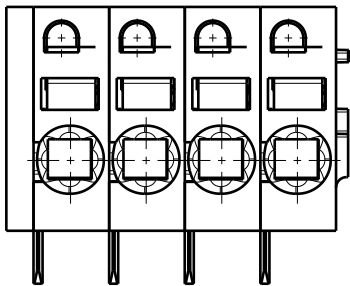

SCREWDRIVER AND  
 CONDUCTOR DIRECTION

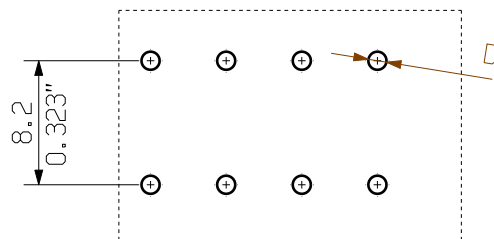
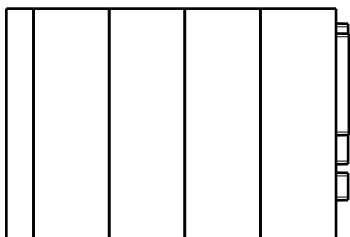

HOLE PATTERN



M 1

WEITERGABE SOWIE VERVIELFAELTIGUNG DIESES DOKUMENTS, VERWERTUNG UND MITTEILUNG SEINES INHALTS SIND VERBOTEN, SOWEIT NICHT AUSDRUECKLICH GESTATTET.  
 ZUWIDERHANDLUNGEN VERPFLICHTEN ZU SCHADENERSATZ. ALLE RECHTE FUER DEN FALL DER PATENT-, GEBRAUCHSMUSTER-, ODER GESCHMACKSMUSTEREINTRAGUNG VORBEHALTEN.  
 THE REPRODUCTION, DISTRIBUTION AND UTILIZATION OF THIS DOCUMENT AS WELL AS THE COMMUNICATION OF ITS CONTENTS TO OTHERS WITHOUT EXPLICIT AUTHORIZATION IS PROHIBITED.  
 OFFENDERS WILL BE HELD LIABLE FOR THE PAYMENT OF DAMAGES. WEIDMUELLER EXCLUSIVELY RESERVES THE RIGHT TO FILE FOR PATENTS, UTILITY MODELS OR DESIGNS.  
 © WEIDMUELLER INTERFACE GmbH & Co.KG

## Recommended wave soldering profiles

**Weidmüller Interface GmbH & Co. KG**  
 Klingenbergstraße 16  
 D-32758 Detmold  
 Germany  
 Fon: +49 5231 14-0  
 Fax: +49 5231 14-292083  
 www.weidmueller.com

### Single Wave:

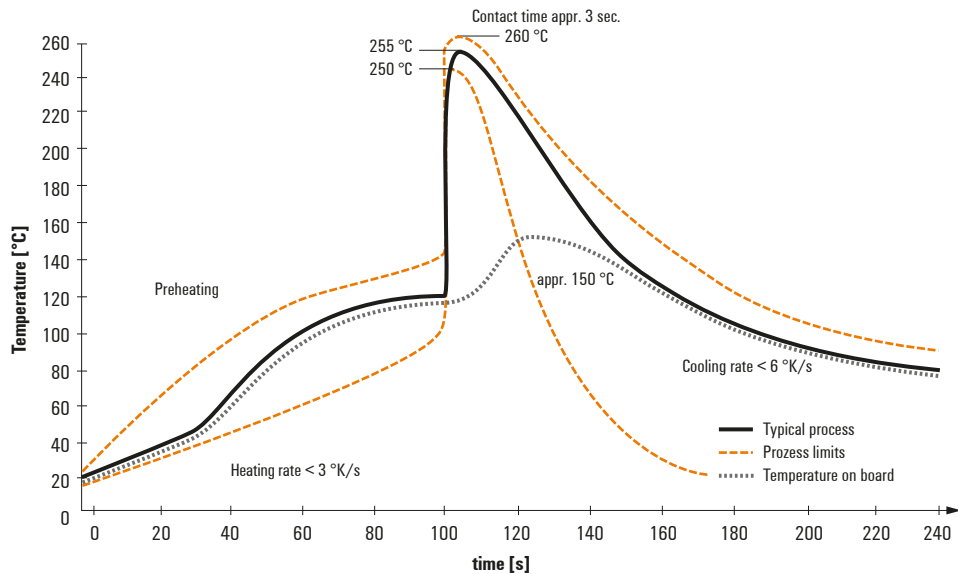

### Double Wave:

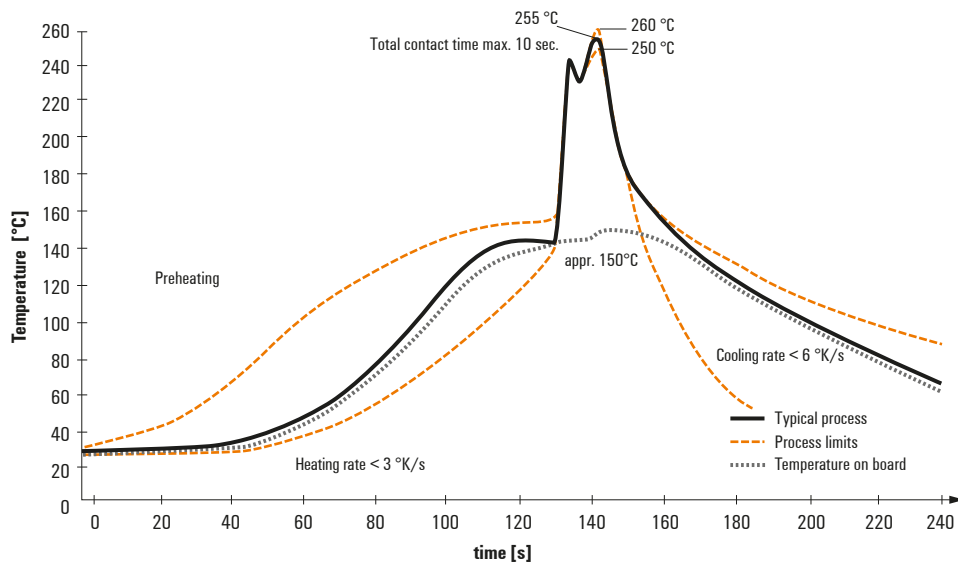

### Wave soldering profiles

Wired connection elements should be processed in accordance with the DIN EN 61760-1 standard. We have included two recommendations for practical wave soldering profiles, with which Weidmüller PCB terminals and connectors are qualified.

When choosing a suitable profile for your application, the following factors also need to be considered:

- PCB thickness
- Proportion of Cu in the layers
- Single/double-sided assembly
- Product range
- Heating and cooling rates

The single and double wave profiles each indicate the recommended operating range, including the maximum soldering temperature of 260°C. In practice, the maximum soldering temperature is quite often well below the above maximum profile.

## X-ON Electronics

Largest Supplier of Electrical and Electronic Components

*Click to view similar products for [Barrier Terminal Blocks](#) category:*

*Click to view products by [Weidmuller](#) manufacturer:*

Other Similar products are found below :

[CR151D20104](#) [670A-RZ-15-KT20](#) [6C1N03](#) [6PCR-02](#) [6PCR-02-008](#) [6PCR-05-008](#) [6PCR-08-008](#) [6PCR-09-008](#) [6PCR-13-006](#) [6PCR-15-006](#) [6PCR-21-006](#) [6PCV-06-008](#) [6PCV-06-716](#) [6PCV-09-001](#) [6PCV-10-009](#) [6PCV-15-008](#) [6PCV-17-1206](#) [6PCV-20-323](#) [6PCV-20-720](#) [6PCV-30-006](#) [6STR-06-006](#) [6STR-08-006](#) [6STR-12-008](#) [6STR-13-006](#) [6STR-14-008](#) [6STR-16-008](#) [6STR-17-008](#) [6STR-21-008](#) [6STR-25-008](#) [6STR-27-008](#) [6STV-03-006](#) [6STV-03-008](#) [6STV-04-006](#) [6STV-09-006](#) [6STV-10-006](#) [6WWR-03-693](#) [6WWV-12-008](#) [72212603](#) [72504-C-50](#) [72506-C](#) [72507-C-50](#) [73203](#) [75505-C](#) [75505-C-50](#) [75510-C](#) [77010-50](#) [7C1N08](#) [812-GP-3/4ST-09](#) [8-1437402-5](#) [8-1437402-7](#)