

LMF 5.00/12/90 3.5SN BK BX

Weidmüller Interface GmbH & Co. KG
Klingenbergstraße 26
D-32758 Detmold
Germany

www.weidmueller.com

Product image

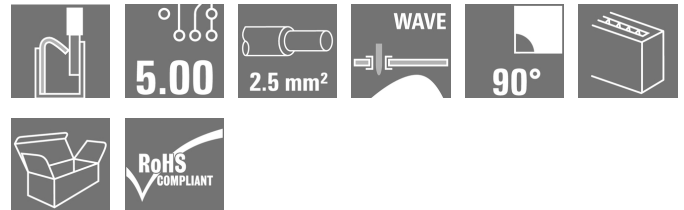

The new LMF allows us to meet the current market requirements for a PCB terminal with PUSH IN connection system for wire cross-sections up to 2.5 mm²

- PUSH IN connection system
- LMF with pusher for opening the terminal point
- LMFS without pusher, the terminal point is opened with a screwdriver
- Integrated test point
- 90° and 180° wire outlet direction

General ordering data

| | |
|--------------|---|
| Version | Printed circuit board terminals, 5.00 mm, Number of poles: 12, 90°, Solder pin length (l): 3.5 mm, tinned, black, PUSH IN with actuator, Clamping range, max. : 2.5 mm ² , Box |
| Order No. | 1424880000 |
| Type | LMF 5.00/12/90 3.5SN BK BX |
| GTIN (EAN) | 4050118229097 |
| Qty. | 25 pc(s). |
| Product data | IEC: 400 V / 24 A / 0.5 - 2.5 mm ² UL: 300 V / 20 A / AWG 24 - AWG 12 |
| Packaging | Box |

Creation date September 16, 2022 5:19:54 AM CEST

LMF 5.00/12/90 3.5SN BK BX
Weidmüller Interface GmbH & Co. KG

Klingenbergstraße 26

D-32758 Detmold

Germany

www.weidmueller.com

Technical data
Dimensions and weights

| | | | |
|--------------------------|------------|-----------------|------------|
| Depth | 19.2 mm | Depth (inches) | 0.756 inch |
| Height | 18.3 mm | Height (inches) | 0.72 inch |
| Height of lowest version | 14.8 mm | Width | 62.7 mm |
| Width (inches) | 2.468 inch | Net weight | 17.697 g |

System parameters

| | | | |
|--|------------------------------|--|--------------------------|
| Product family | OMNIMATE Signal - series LMF | Wire connection method | PUSH IN with actuator |
| Mounting onto the PCB | THT solder connection | Conductor outlet direction | 90° |
| Pitch in mm (P) | 5 mm | Pitch in inches (P) | 0.197 inch |
| Number of poles | 12 | Pin series quantity | 2 |
| Fitted by customer | No | Max. adjacent poles per row | 24 |
| Solder pin length (l) | 3.5 mm | Solder pin dimensions | d = 0.8 mm, 0.6 x 0.8 mm |
| Solder eyelet hole diameter (D) | 1.1 mm | Solder eyelet hole diameter tolerance (D)+ | 0, 1 mm |
| Number of solder pins per pole | 2 | Screwdriver blade | 0.6 x 3.5 |
| Screwdriver blade standard | DIN 5264 | Stripping length | 10 mm |
| L1 in mm | 55 mm | L1 in inches | 2.166 inch |
| Touch-safe protection acc. to DIN VDE 0470 | IP 20 | Touch-safe protection acc. to DIN VDE 57 106 | Safe from finger touch |
| Protection degree | IP20 | | |

Material data

| | | | |
|---------------------------------------|------------|---------------------------------------|------------------|
| Insulating material | Wemid (PA) | Colour | black |
| Colour chart (similar) | RAL 9011 | Comparative Tracking Index (CTI) | ≥ 600 |
| UL 94 flammability rating | V-0 | Contact material | CuSn |
| Contact surface | tinned | Coating | 4-6 µm SN |
| Tinning type | matt | Layer structure of solder connection | 4...6 µm Sn matt |
| Storage temperature, min. | -40 °C | Storage temperature, max. | 70 °C |
| Operating temperature, min. | -50 °C | Operating temperature, max. | 120 °C |
| Temperature range, installation, min. | -25 °C | Temperature range, installation, max. | 120 °C |

Conductors suitable for connection

| | |
|---|----------------------|
| Clamping range, min. | 0.12 mm ² |
| Clamping range, max. | 2.5 mm ² |
| Wire connection cross section AWG, min. | AWG 24 |
| Wire connection cross section AWG, max. | AWG 12 |
| Solid, min. H05(07) V-U | 0.5 mm ² |
| Solid, max. H05(07) V-U | 2.5 mm ² |
| Flexible, min. H05(07) V-K | 0.25 mm ² |
| Flexible, max. H05(07) V-K | 2.5 mm ² |
| w. plastic collar ferrule, DIN 46228 pt 4, min. | 0.25 mm ² |
| w. plastic collar ferrule, DIN 46228 pt 4, max. | 2.5 mm ² |
| w. wire end ferrule, DIN 46228 pt 1, min. | 0.25 mm ² |
| w. wire end ferrule, DIN 46228 pt 1, max. | 2.5 mm ² |
| Plug gauge in accordance with EN 60999 a x b; ø | 2.4 mm x 1.5 mm |

Creation date September 16, 2022 5:19:54 AM CEST

LMF 5.00/12/90 3.5SN BK BX

Weidmüller Interface GmbH & Co. KG

Klingenbergstraße 26

D-32758 Detmold

Germany

www.weidmueller.com

Technical data

| | | | |
|--|--|------------------------------|----------------------------|
| Clampable conductor | Cross-section for conductor connection | Type | fine-wired |
| | | nominal | 0.5 mm ² |
| wire end ferrule | | Stripping length | nominal 12 mm |
| | | Recommended wire-end ferrule | H0.5/16 OR |
| | | Stripping length | nominal 10 mm |
| | | Recommended wire-end ferrule | H0.5/10 |
| Cross-section for conductor connection | Type | fine-wired | |
| | nominal | 0.75 mm ² | |
| wire end ferrule | | Stripping length | nominal 12 mm |
| | | Recommended wire-end ferrule | H0.75/16 W |
| | | Stripping length | nominal 10 mm |
| | | Recommended wire-end ferrule | H0.75/10 |
| Cross-section for conductor connection | Type | fine-wired | |
| | nominal | 1 mm ² | |
| wire end ferrule | | Stripping length | nominal 12 mm |
| | | Recommended wire-end ferrule | H1.0/16D R |
| | | Stripping length | nominal 10 mm |
| | | Recommended wire-end ferrule | H1.0/10 |
| Cross-section for conductor connection | Type | fine-wired | |
| | nominal | 1.5 mm ² | |
| wire end ferrule | | Stripping length | nominal 10 mm |
| | | Recommended wire-end ferrule | H1.5/10 |
| | | Stripping length | nominal 12 mm |
| | | Recommended wire-end ferrule | H1.5/16 R |
| Cross-section for conductor connection | Type | fine-wired | |
| | nominal | 2.5 mm ² | |
| wire end ferrule | | Stripping length | nominal 10 mm |
| | | Recommended wire-end ferrule | H2.5/10 |

Reference text Length of ferrules is to be chosen depending on the product and the rated voltage., The outside diameter of the plastic collar should not be larger than the pitch (P)

Rated data acc. to IEC

| | | | |
|---|------------------------|---|-------------------|
| tested acc. to standard | IEC 60664-1, IEC 61984 | Rated current, min. number of poles (Tu=20°C) | 24 A |
| Rated current, max. number of poles (Tu=20°C) | 24 A | Rated current, min. number of poles (Tu=40°C) | 24 A |
| Rated current, max. number of poles (Tu=40°C) | 24 A | Rated voltage for surge voltage class / pollution degree II/2 | 400 V |
| Rated voltage for surge voltage class / pollution degree III/2 | 320 V | Rated voltage for surge voltage class / pollution degree III/3 | 250 V |
| Rated impulse voltage for surge voltage class/ pollution degree II/2 | 4 kV | Rated impulse voltage for surge voltage class/ pollution degree III/2 | 4 kV |
| Rated impulse voltage for surge voltage class/ contamination degree III/3 | 4 kV | Short-time withstand current resistance | 3 x 1s with 120 A |

Rated data acc. to CSA

| | | | |
|-----------------------------------|--------|-----------------------------------|--------|
| Rated voltage (Use group B / CSA) | 300 V | Rated voltage (Use group D / CSA) | 300 V |
| Rated current (Use group B / CSA) | 20 A | Rated current (Use group D / CSA) | 10 A |
| Wire cross-section, AWG, min. | AWG 24 | Wire cross-section, AWG, max. | AWG 12 |

Creation date September 16, 2022 5:19:54 AM CEST

LMF 5.00/12/90 3.5SN BK BX

Weidmüller Interface GmbH & Co. KG
Klingenbergstraße 26
D-32758 Detmold
Germany

www.weidmueller.com

Technical data

Rated data acc. to UL 1059

| | | | |
|---------------------------------------|--------|---------------------------------------|--------|
| Rated voltage (Use group B / UL 1059) | 300 V | Rated voltage (Use group D / UL 1059) | 300 V |
| Rated current (Use group B / UL 1059) | 20 A | Rated current (Use group D / UL 1059) | 10 A |
| Wire cross-section, AWG, min. | AWG 24 | Wire cross-section, AWG, max. | AWG 12 |

Packing

| | | | |
|-----------|--------|------------|--------|
| Packaging | Box | VPE length | 338 mm |
| VPE width | 130 mm | VPE height | 27 mm |

Classifications

| | | | |
|-------------|-------------|-------------|-------------|
| ETIM 6.0 | EC002643 | ETIM 7.0 | EC002643 |
| ETIM 8.0 | EC002643 | ECLASS 9.0 | 27-44-04-01 |
| ECLASS 9.1 | 27-44-04-01 | ECLASS 10.0 | 27-44-04-01 |
| ECLASS 11.0 | 27-46-01-01 | ECLASS 12.0 | 27-46-01-01 |

Important note

IPC conformity Conformity: The products are developed, manufactured and delivered according international recognized standards and norms and comply with the assured properties in the data sheet resp. fulfill decorative properties in accordance with IPC-A-610 "Class 2". Further claims on the products can be evaluated on request.

- Notes
- Additional variants on request
 - Rated current related to rated cross-section & min. No. of poles.
 - Wire end ferrule without plastic collar to DIN 46228/1
 - Wire end ferrule with plastic collar to DIN 46228/4
 - P on drawing = pitch
 - Rated data refer only to the component itself. Clearance and creepage distances to other components are to be designed in accordance with the relevant application standards.
 - The test point can only be used as potential-pickup point.
 - Long term storage of the product with average temperature of 50 °C and average humidity 70%, 36 months

Approvals

Approvals



ROHS Conform

Downloads

| | |
|------------------|--|
| Engineering Data | CAD data – STEP |
| Catalogues | Catalogues in PDF-format |
| Brochures | FL DRIVES EN FL DRIVES DE |

Creation date September 16, 2022 5:19:54 AM CEST

Catalogue status 09.09.2022 / We reserve the right to make technical changes.

LMF 5.00/12/90 3.5SN BK BX

Weidmüller Interface GmbH & Co. KG
 Klingenbergstraße 26
 D-32758 Detmold
 Germany

www.weidmueller.com

Drawings

Product image

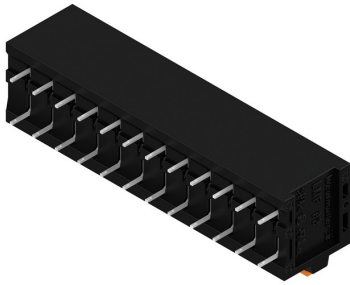

Dimensional drawing

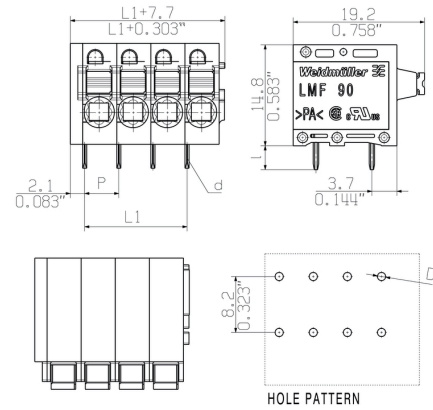

Graph

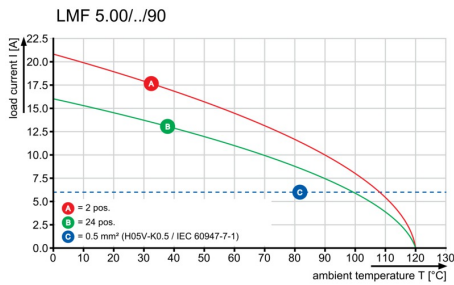

Graph

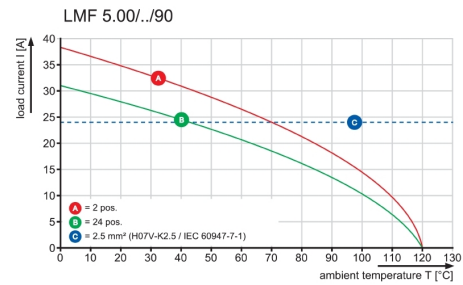

Product benefits

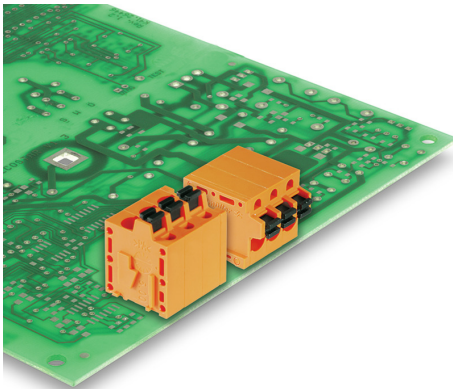

Optional conductor outlet direction
 Stable mechanical design

Product benefits

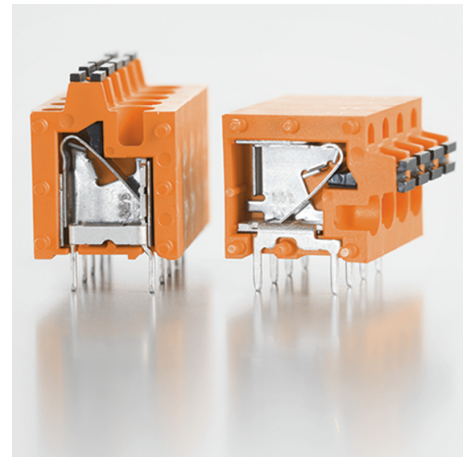

High reliability of the current capacity

LMF 5.00/12/90 3.5SN BK BX

Weidmüller Interface GmbH & Co. KG
Klingenbergstraße 26
D-32758 Detmold
Germany

www.weidmueller.com

Drawings

Product benefits

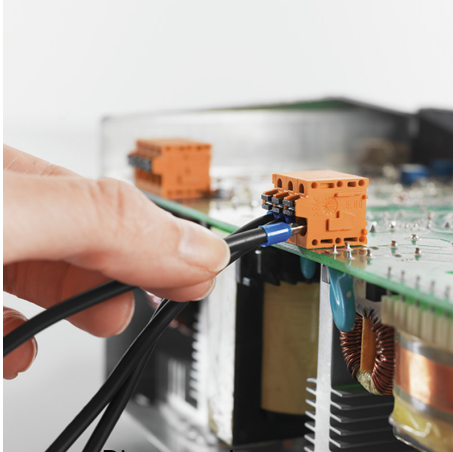

Direct conductor entry
Cross section up to 2.5 mm²

Product benefits

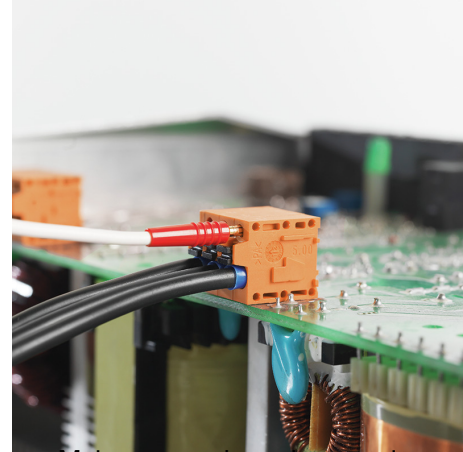

Maintenance through test point

Recommended wave soldering profiles

Weidmüller Interface GmbH & Co. KG
 Klängenbergstraße 16
 D-32758 Detmold
 Germany
 Fon: +49 5231 14-0
 Fax: +49 5231 14-292083
 www.weidmueller.com

Single Wave:



Double Wave:



Wave soldering profiles

Wired connection elements should be processed in accordance with the DIN EN 61760-1 standard. We have included two recommendations for practical wave soldering profiles, with which Weidmüller PCB terminals and connectors are qualified.

When choosing a suitable profile for your application, the following factors also need to be considered:

- PCB thickness
- Proportion of Cu in the layers
- Single/double-sided assembly
- Product range
- Heating and cooling rates

The single and double wave profiles each indicate the recommended operating range, including the maximum soldering temperature of 260°C. In practice, the maximum soldering temperature is quite often well below the above maximum profile.

X-ON Electronics

Largest Supplier of Electrical and Electronic Components

Click to view similar products for [Barrier Terminal Blocks](#) category:

Click to view products by [Weidmuller](#) manufacturer:

Other Similar products are found below :

[CR151D20104](#) [670A-RZ-15-KT20](#) [6C1N03](#) [6PCR-02](#) [6PCR-02-008](#) [6PCR-05-008](#) [6PCR-08-008](#) [6PCR-09-008](#) [6PCR-13-006](#) [6PCR-15-006](#) [6PCR-21-006](#) [6PCV-06-008](#) [6PCV-06-716](#) [6PCV-09-001](#) [6PCV-15-008](#) [6PCV-17-1206](#) [6PCV-20-323](#) [6STR-06-006](#) [6STR-08-006](#) [6STR-12-008](#) [6STR-13-006](#) [6STR-14-008](#) [6STR-16-008](#) [6STR-17-008](#) [6STR-21-008](#) [6STR-25-008](#) [6STR-27-008](#) [6STV-03-008](#) [6STV-04-006](#) [6STV-09-006](#) [6STV-10-006](#) [6WWV-11-008](#) [6WWV-12-008](#) [6WWV-16-008](#) [71106-C](#) [71502-50](#) [71507-47-50](#) [72504-C-50](#) [72506-C](#) [72507-C-50](#) [72508-56](#) [73203](#) [75505-C-50](#) [7C1N08](#) [812-GP-3/4ST-09](#) [812-GPZ-03PSB](#) [8-1437402-5](#) [8-1437402-7](#) [8PCR-06-006](#) [8PCR-11-006](#)