

## BLT 5.08HC/02/180 SN OR BX

**Weidmüller Interface GmbH & Co. KG**

Klingenbergstraße 26

D-32758 Detmold

Germany

www.weidmueller.com

### Product image

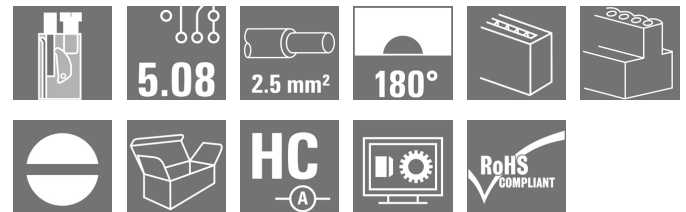

Similar to illustration

Female plugs with TOP screw connection system for connecting wires with straight 180° outlet direction. The female connectors provide space for labelling and can be coded. HC = High Current.

### General ordering data

Version	PCB plug-in connector, female plug, 5.08 mm, Number of poles: 2, 180°, TOP connection, Clamping range, max. : 2.5 mm², Box
Order No.	<a href="#">1499560000</a>
Type	BLT 5.08HC/02/180 SN OR BX
GTIN (EAN)	4008190060640
Qty.	180 pc(s).
Product data	IEC: 400 V / 27 A / 0.2 - 2.5 mm² UL: 300 V / 17 A / AWG 26 - AWG 14
Packaging	Box

Creation date September 16, 2022 6:37:13 AM CEST

## BLT 5.08HC/02/180 SN OR BX

Weidmüller Interface GmbH &amp; Co. KG

Klingenbergstraße 26

D-32758 Detmold

Germany

www.weidmueller.com

## Technical data

## Dimensions and weights

Depth	31.8 mm	Depth (inches)	1.252 inch
Height	12.2 mm	Height (inches)	0.48 inch
Width	10.16 mm	Width (inches)	0.4 inch
Net weight	6.122 g		

## System Parameters

Product family	OMNIMATE Signal - series BL/SL 5.08		
Type of connection	Field connection		
Wire connection method	TOP connection		
Pitch in mm (P)	5.08 mm		
Pitch in inches (P)	0.2 inch		
Conductor outlet direction	180°		
Number of poles	2		
L1 in mm	5.08 mm		
L1 in inches	0.2 inch		
Number of rows	1		
Pin series quantity	1		
Rated cross-section	2.5 mm <sup>2</sup>		
Touch-safe protection acc. to DIN VDE 57 106	Safe from finger touch		
Protection degree	IP20		
Volume resistance	≤5 mΩ		
Can be coded	Yes		
Stripping length	13 mm		
Clamping screw	M 2.5		
Screwdriver blade	0.6 x 3.5		
Screwdriver blade standard	DIN 5264		
Plugging cycles	25		
Plugging force/pole, max.	8 N		
Pulling force/pole, max.	7 N		
Tightening torque	Torque type	Wire connection	
	Usage information	Tightening torque	min. 0.4 Nm max. 0.5 Nm

## Material data

Insulating material	PBT	Colour	orange
Colour chart (similar)	RAL 2000	Insulating material group	IIIa
Comparative Tracking Index (CTI)	≥ 200	UL 94 flammability rating	V-0
Contact material	CuSn	Contact surface	tinned
Layer structure of plug contact	4...8 μm Sn hot-dip tinned	Storage temperature, min.	-40 °C
Storage temperature, max.	70 °C	Operating temperature, min.	-50 °C
Operating temperature, max.	100 °C	Temperature range, installation, min.	-25 °C
Temperature range, installation, max.	100 °C		

## Conductors suitable for connection

Clamping range, min.	0.13 mm <sup>2</sup>
Clamping range, max.	2.5 mm <sup>2</sup>
Wire connection cross section AWG, min.	AWG 26
Wire connection cross section AWG, max.	AWG 14
Solid, min. H05(07) V-U	0.2 mm <sup>2</sup>

Creation date September 16, 2022 6:37:13 AM CEST

## BLT 5.08HC/02/180 SN OR BX

**Weidmüller Interface GmbH & Co. KG**  
 Klingenbergstraße 26  
 D-32758 Detmold  
 Germany

www.weidmueller.com

## Technical data

Solid, max. H05(07) V-U	2.5 mm <sup>2</sup>
Flexible, min. H05(07) V-K	0.2 mm <sup>2</sup>
Flexible, max. H05(07) V-K	2.5 mm <sup>2</sup>
w. plastic collar ferrule, DIN 46228 pt 4, 0.2 mm <sup>2</sup> min.	
w. plastic collar ferrule, DIN 46228 pt 4, 1.5 mm <sup>2</sup> max.	
w. wire end ferrule, DIN 46228 pt 1, 0.2 mm <sup>2</sup> min.	
w. wire end ferrule, DIN 46228 pt 1, 1.5 mm <sup>2</sup> max.	
Plug gauge in accordance with EN 60999 a x b; ø	2.4 mm x 1.5 mm ; 2.4 mm

Clampable conductor	Cross-section for conductor connection	Type	fine-wired	
		nominal	0.5 mm <sup>2</sup>	
	wire end ferrule	Stripping length	nominal	14 mm
		Recommended wire-end ferrule	<a href="#">H0.5/18 OR</a>	
	Cross-section for conductor connection	Type	fine-wired	
		nominal	1 mm <sup>2</sup>	
	wire end ferrule	Stripping length	nominal	15 mm
		Recommended wire-end ferrule	<a href="#">H1.0/18 GE</a>	
	Cross-section for conductor connection	Type	fine-wired	
		nominal	1.5 mm <sup>2</sup>	
	wire end ferrule	Stripping length	nominal	15 mm
		Recommended wire-end ferrule	<a href="#">H1.5/18D SW</a>	
Stripping length		nominal	12 mm	
Recommended wire-end ferrule		<a href="#">H1.5/12</a>		

Reference text The outside diameter of the plastic collar should not be larger than the pitch (P), Length of ferrules is to be chosen depending on the product and the rated voltage.

### Rated data acc. to IEC

tested acc. to standard	IEC 60664-1, IEC 61984	Rated current, min. number of poles (Tu=20°C)	27 A
Rated current, max. number of poles (Tu=20°C)	19 A	Rated current, min. number of poles (Tu=40°C)	24 A
Rated current, max. number of poles (Tu=40°C)	16 A	Rated voltage for surge voltage class / pollution degree II/2	400 V
Rated voltage for surge voltage class / pollution degree III/2	320 V	Rated voltage for surge voltage class / pollution degree III/3	250 V
Rated impulse voltage for surge voltage class/ pollution degree II/2	4 kV	Rated impulse voltage for surge voltage class/ pollution degree III/2	4 kV
Rated impulse voltage for surge voltage class/ contamination degree III/3	4 kV	Short-time withstand current resistance	3 x 1s with 100 A

## BLT 5.08HC/02/180 SN OR BX

**Weidmüller Interface GmbH & Co. KG**  
 Klingenbergstraße 26  
 D-32758 Detmold  
 Germany

www.weidmueller.com

## Technical data

### Rated data acc. to CSA

Institute (CSA)		Certificate No. (CSA)	
		200039-1121690	
Rated voltage (Use group B / CSA)	300 V	Rated voltage (Use group D / CSA)	300 V
Rated current (Use group B / CSA)	15 A	Rated current (Use group D / CSA)	15 A
Wire cross-section, AWG, min.	AWG 26	Wire cross-section, AWG, max.	AWG 14
Reference to approval values	Specifications are maximum values, details - see approval certificate.		

### Packing

Packaging	Box	VPE length	351 mm
VPE width	135 mm	VPE height	36 mm

### Type tests

Test: Durability of markings	Standard	DIN EN 61984 section 7.3.2 / 09.02 taking pattern from DIN EN 60068-2-70 / 07.96		
	Test	mark of origin, type of material, date clock		
	Evaluation	available		
	Test	durability		
Test: Misengagement (Non-interchangeability)	Standard	DIN EN 61984 section 6.3 and 6.9.1 / 09.02, DIN EN 60512-13-5 / 11.06		
	Test	180° turned with coding elements		
	Evaluation	passed		
	Test	visual examination		
Test: Clampable cross section	Evaluation	passed		
	Conductor type	Type of conductor and conductor cross-section	solid 0.08 mm <sup>2</sup>	
		Type of conductor and conductor cross-section	stranded 0.08 mm <sup>2</sup>	
		Type of conductor and conductor cross-section	solid 2.5 mm <sup>2</sup>	
		Type of conductor and conductor cross-section	stranded 2.5 mm <sup>2</sup>	
		Type of conductor and conductor cross-section	AWG 26/1	
		Type of conductor and conductor cross-section	AWG 26/19	
		Type of conductor and conductor cross-section	AWG 14/1	
		Type of conductor and conductor cross-section	AWG 14/19	
	Evaluation	passed		

**BLT 5.08HC/02/180 SN OR BX**

**Weidmüller Interface GmbH & Co. KG**  
 Klingenbergstraße 26  
 D-32758 Detmold  
 Germany

www.weidmueller.com

**Technical data**

Test for damage to and accidental loosening of conductors

Standard	DIN EN 60999-1 section 9.4 / 12.00	
Requirement	0.2 kg	
Conductor type	Type of conductor and conductor cross-section	AWG 28/1
	Type of conductor and conductor cross-section	AWG 26/19
Evaluation	passed	
Requirement	0.3 kg	
Conductor type	Type of conductor and conductor cross-section	solid 0.5 mm <sup>2</sup>
	Type of conductor and conductor cross-section	stranded 0.5 mm <sup>2</sup>
Evaluation	passed	
Requirement	0.7 kg	
Conductor type	Type of conductor and conductor cross-section	solid 2.5 mm <sup>2</sup>
	Type of conductor and conductor cross-section	stranded 2.5 mm <sup>2</sup>
	Type of conductor and conductor cross-section	AWG 14/1
	Type of conductor and conductor cross-section	AWG 14/19
Evaluation	passed	

**BLT 5.08HC/02/180 SN OR BX**

**Weidmüller Interface GmbH & Co. KG**  
 Klingenbergstraße 26  
 D-32758 Detmold  
 Germany

www.weidmueller.com

**Technical data**

Pull-out test	Standard	DIN EN 60999-1 section 9.5 / 12.00	
	Requirement	≥5 N	
	Conductor type	Type of conductor and conductor cross-section	AWG 28/1
	Evaluation	passed	
	Requirement	≥10 N	
	Conductor type	Type of conductor and conductor cross-section	AWG 26/19
	Evaluation	passed	
	Requirement	≥20 N	
	Conductor type	Type of conductor and conductor cross-section	solid 0.5 mm <sup>2</sup>
		Type of conductor and conductor cross-section	stranded 0.5 mm <sup>2</sup>
	Evaluation	passed	
	Requirement	≥40 N	
	Conductor type	Type of conductor and conductor cross-section	AWG 14/1
		Type of conductor and conductor cross-section	AWG 14/19
	Evaluation	passed	
	Requirement	≥50 N	
	Conductor type	Type of conductor and conductor cross-section	solid 2.5 mm <sup>2</sup>
		Type of conductor and conductor cross-section	stranded 2.5 mm <sup>2</sup>
	Evaluation	passed	

**Classifications**

ETIM 6.0	EC002638	ETIM 7.0	EC002638
ETIM 8.0	EC002638	ECLASS 9.0	27-44-03-09
ECLASS 9.1	27-44-03-09	ECLASS 10.0	27-44-03-09
ECLASS 11.0	27-46-02-02	ECLASS 12.0	27-46-02-02

**BLT 5.08HC/02/180 SN OR BX****Weidmüller Interface GmbH & Co. KG**

Klingenbergstraße 26

D-32758 Detmold

Germany

www.weidmueller.com

**Technical data****Important note**

IPC conformity	Conformity: The products are developed, manufactured and delivered according international recognized standards and norms and comply with the assured properties in the data sheet resp. fulfill decorative properties in accordance with IPC-A-610 "Class 2". Further claims on the products can be evaluated on request.
Notes	<ul style="list-style-type: none"> <li>• Additional variants on request</li> <li>• Gold-plated contact surfaces on request</li> <li>• Rated current related to rated cross-section &amp; min. No. of poles.</li> <li>• Wire end ferrule without plastic collar to DIN 46228/1</li> <li>• Wire end ferrule with plastic collar to DIN 46228/4</li> <li>• Crimp form A for wire end ferrules with PZ 6/5 crimping tool are recommended for the largest cable sizes.</li> <li>• P on drawing = pitch</li> <li>• Rated data refer only to the component itself. Clearance and creepage distances to other components are to be designed in accordance with the relevant application standards.</li> <li>• Long term storage of the product with average temperature of 50 °C and average humidity 70%, 36 months</li> </ul>

**Approvals**

Approvals



ROHS	Conform
UL File Number Search	UL Website
Certificate No. (cURus)	E60693

**Downloads**

Approval/Certificate/Document of Conformity	<a href="#">CB Certificate</a> <a href="#">CB Testreport</a> <a href="#">Declaration of the Manufacturer</a>
Engineering Data	<a href="#">CAD data – STEP</a>
Engineering Data	<a href="#">WSCAD</a>
Catalogues	<a href="#">Catalogues in PDF-format</a>
Brochures	<a href="#">FL DRIVES EN</a> <a href="#">MB DEVICE MANUF. EN</a> <a href="#">FL DRIVES DE</a> <a href="#">FL BUILDING SAFETY EN</a> <a href="#">FL APPL LED LIGHTING EN</a> <a href="#">FLIndustr.CONTROLS EN</a> <a href="#">FL MACHINE SAFETY EN</a> <a href="#">FL HEATING ELECTR EN</a> <a href="#">FL APPL INVERTER EN</a> <a href="#">FL_BASE_STATION_EN</a> <a href="#">FL ELEVATOR EN</a> <a href="#">FL POWER SUPPLY EN</a> <a href="#">FL 72H SAMPLE SER EN</a> <a href="#">PO OMNIMATE EN</a> <a href="#">PO OMNIMATE EN</a>

Creation date September 16, 2022 6:37:13 AM CEST

Catalogue status 09.09.2022 / We reserve the right to make technical changes.

7

**Data sheet**

**BLT 5.08HC/02/180 SN OR BX**

**Weidmüller Interface GmbH & Co. KG**  
 Klingenbergstraße 26  
 D-32758 Detmold  
 Germany

www.weidmueller.com

**Drawings**

**Dimensional drawing**

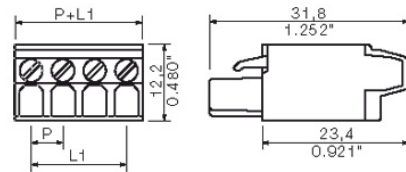

**Graph**

BLT 5.08HC/./180 - SL-SMT 5.08HC/./90

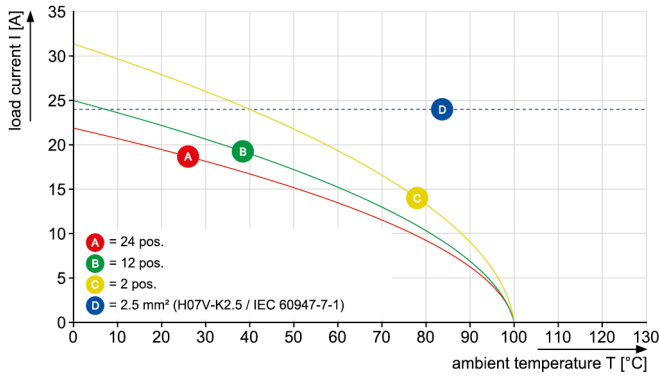



MASSE OHNE TOLERANZ SIND KEINE PRUEFFMASSE  
 DIMS. WITHOUT TOLERANCE ARE NOT CONTROL DIMS.

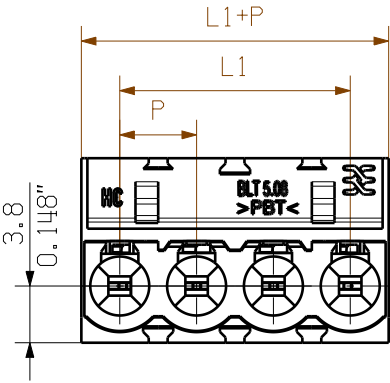

SHOWN: BLT 5.08HC/04/180

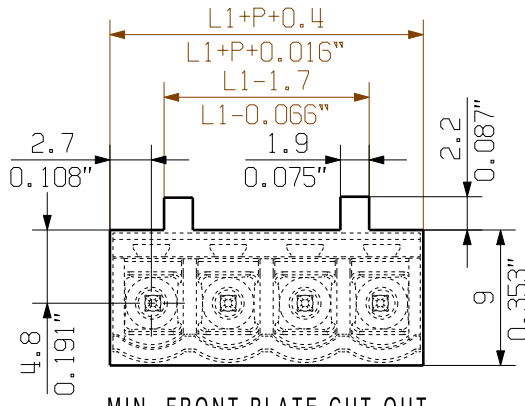
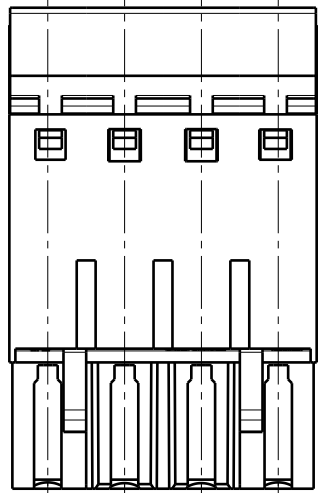
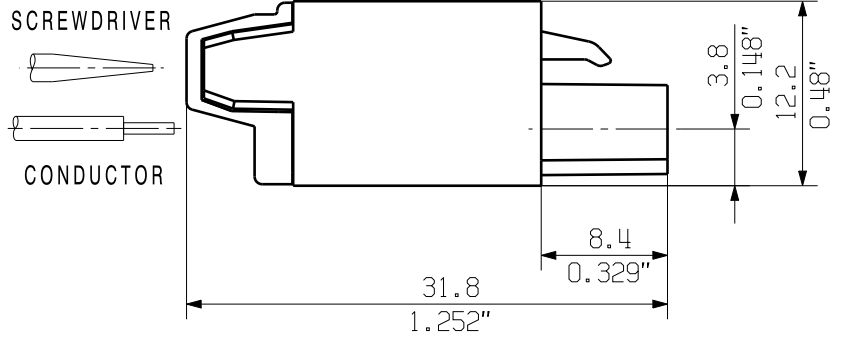

MIN. FRONT PLATE CUT-OUT

M 1/1

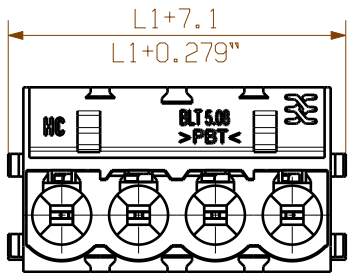
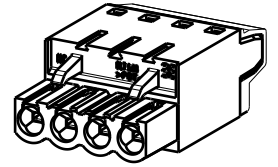

SHOWN: BLT 5.08HC/04/180B

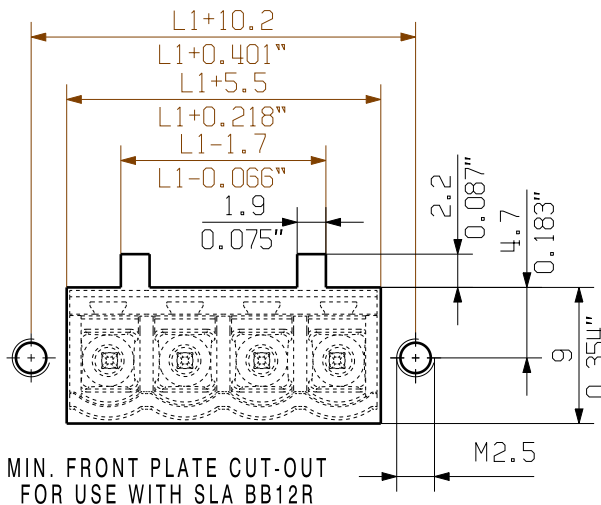
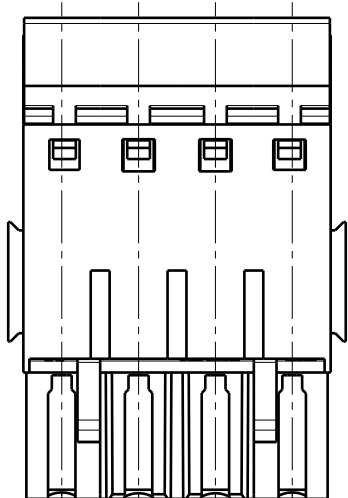
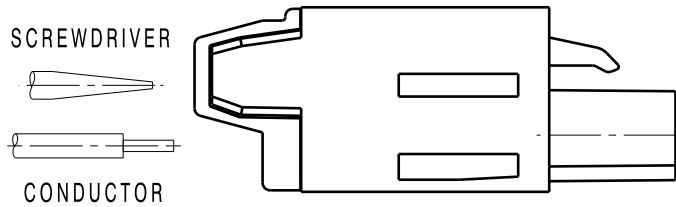

MIN. FRONT PLATE CUT-OUT  
 FOR USE WITH SLA BB12R

M 1/1

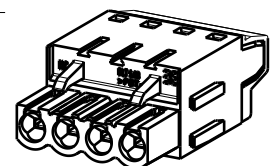

ALLGEMEINGUELTIGE KUNDENZEICHUNG, AKTUELLER STAND NUR AUF ANFRAGE  
 GENERAL CUSTOMER DRAWING, TOPICAL VERSION ONLY IF REQUIRED

WEITERGABE SOWIE VERVIELFAELTIGUNG DIESES DOKUMENTS, VERWERTUNG UND MITTEILUNG SEINES INHALTS SIND VERBOTEN, SOWEIT NICHT AUSDRUECKLICH GESTATTET.  
 ZUWIDERHANDLUNGEN VERPFLICHTEN ZU SCHADENERSATZ. ALLE RECHTE FUER DEN FALL DER PATENT-, GEBRAUCHSMUSTER- ODER GESCHMACKSMUSTEREINTRAGUNG VORBEHALTEN.  
 THE REPRODUCTION, DISTRIBUTION AND UTILIZATION OF THIS DOCUMENT AS WELL AS THE COMMUNICATION OF ITS CONTENTS TO OTHERS WITHOUT EXPLICIT AUTHORIZATION IS PROHIBITED.  
 OFFENDERS WILL BE HELD LIABLE FOR THE PAYMENT OF DAMAGES. WEIDMUELLER EXCLUSIVELY RESERVES THE RIGHT TO FILE FOR PATENTS, UTILITY MODELS OR DESIGNS.  
 © WEIDMUELLER INTERFACE GmbH & Co.KG

## X-ON Electronics

Largest Supplier of Electrical and Electronic Components

*Click to view similar products for [Pluggable Terminal Blocks](#) category:*

*Click to view products by [Weidmuller](#) manufacturer:*

Other Similar products are found below :

[57.510.0053](#) [MC 1.5/ 6-ST-3.5 GY AU](#) [ET02015000J0G](#) [734-104](#) [734-302](#) [860505](#) [860516](#) [860810](#) [GBPACX-12](#) [PV05-5,08-K](#) [PVP02-5,00](#)  
[PVP03-3,50](#) [PVP04-3,50](#) [PVS02-5,00](#) [1-1986160-3](#) [1377680000](#) [1513860000](#) [1531000000](#) [1546228-5](#) [1610550000](#) [ELFH16150](#)  
[ELFP03110](#) [ELFP10210](#) [ELFT06250](#) [ELVP03100](#) [1700101](#) [1700410](#) [1702246](#) [1705229](#) [1710175](#) [1714537](#) [1717806](#) [1719600](#) [1728941](#)  
[1734692](#) [1734795](#) [1740628](#) [1740990](#) [1746952](#) [1750207](#) [1752441](#) [1752865](#) [1754115](#) [1754144](#) [1756913](#) [1760051](#) [1760336](#) [1765111](#)  
[1777701](#) [1783410](#)