

BL 3.50/06/90 SN OR BX
Weidmüller Interface GmbH & Co. KG

Klingenbergstraße 26

D-32758 Detmold

Germany

www.weidmueller.com

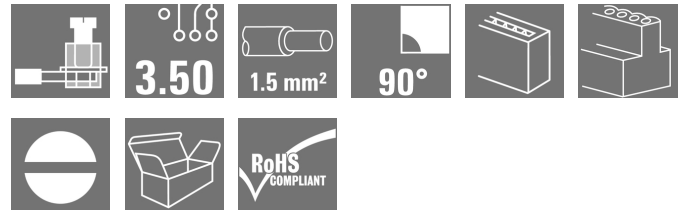
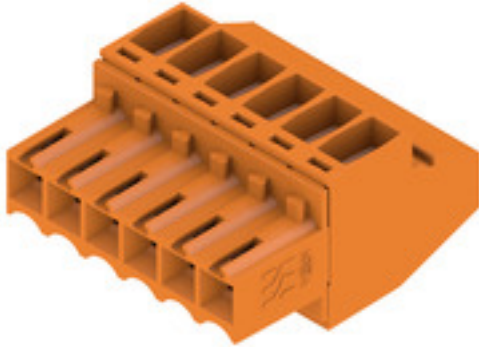
Product image

Female connectors with clamping yoke screw system for connecting conductors at 3.50 mm pitch. They provide space for labelling and can be coded.

General ordering data

Version	PCB plug-in connector, female plug, 3.50 mm, Number of poles: 6, 90°, Clamping yoke connection, Clamping range, max.: 1.5 mm², Box
Order No.	1638590000
Type	BL 3.50/06/90 SN OR BX
GTIN (EAN)	4008190276133
Qty.	84 pc(s).
Product data	IEC: 320 V / 12 A / 0.2 - 1.5 mm² UL: 300 V / 8 A / AWG 28 - AWG 14
Packaging	Box

Creation date January 26, 2022 11:53:37 PM CET

BL 3.50/06/90 SN OR BX

Weidmüller Interface GmbH & Co. KG

Klingenbergstraße 26

D-32758 Detmold

Germany

www.weidmueller.com

Technical data

Dimensions and weights

Depth	22.45 mm	Depth (inches)	0.884 inch
Height	12 mm	Height (inches)	0.472 inch
Width	21 mm	Width (inches)	0.827 inch
Net weight	3.702 g		

System Parameters

Product family	OMNIMATE Signal - series BL/SL 3.50		
Type of connection	Field connection		
Wire connection method	Clamping yoke connection		
Pitch in mm (P)	3.5 mm		
Pitch in inches (P)	0.138 inch		
Conductor outlet direction	90°		
Number of poles	6		
L1 in mm	17.5 mm		
L1 in inches	0.689 inch		
Number of rows	1		
Pin series quantity	1		
Rated cross-section	1.5 mm ²		
Touch-safe protection acc. to DIN VDE 57 106	Safe from finger touch		
Touch-safe protection acc. to DIN VDE 0470	IP 20		
Volume resistance	≤5 mΩ		
Can be coded	Yes		
Stripping length	6 mm		
Clamping screw	M 2		
Screwdriver blade	0.4 x 2.5		
Screwdriver blade standard	DIN 5264		
Plugging cycles	25		
Plugging force/pole, max.	7 N		
Pulling force/pole, max.	5 N		
Tightening torque	Torque type	Wire connection	
	Usage information	Tightening torque	min. 0.2 Nm max. 0.25 Nm

Material data

Insulating material	PBT	Colour	orange
Colour chart (similar)	RAL 2000	Insulating material group	IIIa
Comparative Tracking Index (CTI)	≥ 200	UL 94 flammability rating	V-0
Contact material	Copper alloy	Contact surface	tinned
Layer structure of plug contact	4...8 μm Sn hot-dip tinned	Storage temperature, min.	-40 °C
Storage temperature, max.	70 °C	Operating temperature, min.	-50 °C
Operating temperature, max.	100 °C	Temperature range, installation, min.	-30 °C
Temperature range, installation, max.	100 °C		

Conductors suitable for connection

Clamping range, min.	0.08 mm ²
Clamping range, max.	1.5 mm ²
Wire connection cross section AWG, min.	AWG 28
Wire connection cross section AWG, max.	AWG 14

Creation date January 26, 2022 11:53:37 PM CET

BL 3.50/06/90 SN OR BX

Weidmüller Interface GmbH & Co. KG
 Klingenbergstraße 26
 D-32758 Detmold
 Germany

www.weidmueller.com

Technical data

Solid, min. H05(07) V-U	0.2 mm ²
Solid, max. H05(07) V-U	1.5 mm ²
Flexible, min. H05(07) V-K	0.2 mm ²
Flexible, max. H05(07) V-K	1.5 mm ²
w. plastic collar ferrule, DIN 46228 pt 4, min.	0.2 mm ²
w. plastic collar ferrule, DIN 46228 pt 4, max.	1.5 mm ²
w. wire end ferrule, DIN 46228 pt 1, min.	0.2 mm ²
w. wire end ferrule, DIN 46228 pt 1, max.	1.5 mm ²
Plug gauge in accordance with EN 60999 a x b; ø	2.4 mm x 1.5 mm

Clampable conductor	Cross-section for conductor connection	Type	fine-wired
		nominal	0.5 mm ²
wire end ferrule		Stripping length	nominal 8 mm
		Recommended wire-end ferrule	H0.5/12 OR
		Stripping length	nominal 6 mm
		Recommended wire-end ferrule	H0.5/6
Cross-section for conductor connection		Type	fine-wired
		nominal	0.75 mm ²
		Stripping length	nominal 8 mm
		Recommended wire-end ferrule	H0.75/12 W
wire end ferrule		Stripping length	nominal 6 mm
		Recommended wire-end ferrule	H0.75/6
		Stripping length	nominal 8 mm
		Recommended wire-end ferrule	H1.0/12 GE
Cross-section for conductor connection		Type	fine-wired
		nominal	1 mm ²
		Stripping length	nominal 8 mm
		Recommended wire-end ferrule	H1.0/6
wire end ferrule		Stripping length	nominal 6 mm
		Recommended wire-end ferrule	H1.0/6
		Stripping length	nominal 8 mm
		Recommended wire-end ferrule	H0.25/10 HBL
Cross-section for conductor connection		Type	fine-wired
		nominal	0.25 mm ²
		Stripping length	nominal 8 mm
		Recommended wire-end ferrule	H0.25/5
wire end ferrule		Stripping length	nominal 5 mm
		Recommended wire-end ferrule	H0.25/5
		Stripping length	nominal 8 mm
		Recommended wire-end ferrule	H0.34/10 TK
Cross-section for conductor connection		Type	fine-wired
		nominal	0.34 mm ²
		Stripping length	nominal 8 mm
		Recommended wire-end ferrule	H0.34/10 TK

Reference text The outside diameter of the plastic collar should not be larger than the pitch (P). Length of ferrules is to be chosen depending on the product and the rated voltage.

BL 3.50/06/90 SN OR BX

Weidmüller Interface GmbH & Co. KG

Klingenbergstraße 26

D-32758 Detmold

Germany

www.weidmueller.com

Technical data

Rated data acc. to IEC

tested acc. to standard	IEC 60664-1, IEC 61984	Rated current, min. number of poles (Tu=20°C)	12 A
Rated current, max. number of poles (Tu=20°C)	10 A	Rated current, min. number of poles (Tu=40°C)	10 A
Rated current, max. number of poles (Tu=40°C)	8 A	Rated voltage for surge voltage class / pollution degree II/2	320 V
Rated voltage for surge voltage class / pollution degree III/2	160 V	Rated voltage for surge voltage class / pollution degree III/3	160 V
Rated impulse voltage for surge voltage class/ pollution degree II/2	2.5 kV	Rated impulse voltage for surge voltage class/ pollution degree III/2	2.5 kV
Rated impulse voltage for surge voltage class/ contamination degree III/3	2.5 kV	Short-time withstand current resistance	3 x 1s with 100 A

Rated data acc. to CSA

Institute (CSA)		Certificate No. (CSA)	154685-1318353
Rated voltage (Use group B / CSA)	300 V	Rated voltage (Use group D / CSA)	300 V
Rated current (Use group B / CSA)	10 A	Rated current (Use group D / CSA)	10 A
Wire cross-section, AWG, min.	AWG 28	Wire cross-section, AWG, max.	AWG 14
Reference to approval values	Specifications are maximum values, details - see approval certificate.		

Rated data acc. to UL 1059

Institute (UR)		Certificate No. (UR)	E60693
Rated voltage (Use group B / UL 1059)	300 V	Rated voltage (Use group D / UL 1059)	300 V
Rated current (Use group B / UL 1059)	8 A	Rated current (Use group D / UL 1059)	8 A
Wire cross-section, AWG, min.	AWG 28	Wire cross-section, AWG, max.	AWG 14
Reference to approval values	Specifications are maximum values, details - see approval certificate.		

Packing

Packaging	Box	VPE length	349 mm
VPE width	136 mm	VPE height	31 mm

Type tests

Test: Durability of markings	Standard	DIN EN 61984 section 7.3.2 / 09.02 taking pattern from DIN EN 60068-2-70 / 07.96
	Test	mark of origin, type identification, approval marking SEV, approval marking CSA
	Evaluation	available
	Test	durability
	Evaluation	passed

Creation date January 26, 2022 11:53:37 PM CET

Catalogue status 14.01.2022 / We reserve the right to make technical changes.

BL 3.50/06/90 SN OR BX

Weidmüller Interface GmbH & Co. KG
 Klingenbergstraße 26
 D-32758 Detmold
 Germany

www.weidmueller.com

Technical data

Test: Misengagement (Non-interchangeability)	Standard	DIN EN 61984 section 6.3 and 6.9.1 / 09.02, DIN IEC 60512 part 7 section 5 / 05.94		
	Test	180° turned with coding elements		
	Evaluation	passed		
Test: Clampable cross section	Standard	DIN EN 60999-1 section 7 and 9.1 / 12.00, DIN EN 60947-1 section 8.2.4.5.1 / 12.99		
	Conductor type	Type of conductor and conductor cross-section	solid 0.2 mm ²	
		Type of conductor and conductor cross-section	stranded 0.2 mm ²	
		Type of conductor and conductor cross-section	solid 1.5 mm ²	
		Type of conductor and conductor cross-section	stranded 1.5 mm ²	
		Type of conductor and conductor cross-section	AWG 28/1	
		Type of conductor and conductor cross-section	AWG 28/19	
		Type of conductor and conductor cross-section	AWG 16/1	
		Type of conductor and conductor cross-section	AWG 16/19	
	Evaluation	passed		
Test for damage to and accidental loosening of conductors	Standard	DIN EN 60999-1 section 9.4 / 12.00		
	Requirement	0.2 kg		
	Conductor type	Type of conductor and conductor cross-section	AWG 28/1	
		Type of conductor and conductor cross-section	AWG 28/19	
	Evaluation	passed		
	Requirement	0.3 kg		
	Conductor type	Type of conductor and conductor cross-section	2 × AWG 24/1	
		Type of conductor and conductor cross-section	2 × AWG 24/19 with wire end ferrule	
	Evaluation	passed		
	Requirement	0.4 kg		
Conductor type	Type of conductor and conductor cross-section	solid 1.5 mm ²		
	Type of conductor and conductor cross-section	stranded 1.5 mm ²		
	Type of conductor and conductor cross-section	AWG 16/7		
Evaluation	passed			

BL 3.50/06/90 SN OR BX

Weidmüller Interface GmbH & Co. KG

Klingenbergstraße 26

D-32758 Detmold

Germany

www.weidmueller.com

Technical data

Pull-out test	Standard	DIN EN 60999-1 section 9.5 / 12.00		
	Requirement	≥5 N		
	Conductor type	Type of conductor and conductor cross-section	AWG 28/1	
		Type of conductor and conductor cross-section	AWG 28/19	
	Evaluation	passed		
	Requirement	≥10 N		
	Conductor type	Type of conductor and conductor cross-section	2 × AWG 24/1	
		Type of conductor and conductor cross-section	2 × AWG 24/19 with wire end ferrule	
	Evaluation	passed		
	Requirement	≥40 N		
	Conductor type	Type of conductor and conductor cross-section	H05V-U1.5	
		Type of conductor and conductor cross-section	H05V-K1.5	
		Type of conductor and conductor cross-section	AWG 16/7	
	Evaluation	passed		

Classifications

ETIM 6.0	EC002638	ETIM 7.0	EC002638
ETIM 8.0	EC002638	ECLASS 9.0	27-44-03-09
ECLASS 9.1	27-44-03-09	ECLASS 10.0	27-44-03-09
ECLASS 11.0	27-46-02-02		

Important note

IPC conformity	Conformity: The products are developed, manufactured and delivered according international recognized standards and norms and comply with the assured properties in the data sheet resp. fulfill decorative properties in accordance with IPC-A-610 "Class 2". Further claims on the products can be evaluated on request.
Notes	<ul style="list-style-type: none"> • Additional colours on request • Gold-plated contact surfaces on request • Rated current related to rated cross-section & min. No. of poles. • Max. outer diameter of the conductor: 2.9 mm • Wire end ferrule without plastic collar to DIN 46228/1 • Wire end ferrule with plastic collar to DIN 46228/4 • P on drawing = pitch • Rated data refer only to the component itself. Clearance and creepage distances to other components are to be designed in accordance with the relevant application standards.

BL 3.50/06/90 SN OR BX**Weidmüller Interface GmbH & Co. KG**
Klingenbergstraße 26
D-32758 Detmold
Germany

www.weidmueller.com

Technical data**Approvals**

Approvals

ROHS Conform
UL File Number Search E60693**Downloads**

Approval/Certificate/Document of Conformity	Declaration of the Manufacturer
Engineering Data	CAD data – STEP
Catalogues	Catalogues in PDF-format
Brochures	FL DRIVES EN MB DEVICE MANUF. EN FL DRIVES DE FL BUILDING SAFETY EN FL APPL LED LIGHTING EN FLIndustr.CONTROLS EN FL MACHINE SAFETY EN FL HEATING ELECTR EN FL APPL INVERTER EN FL_BASE_STATION_EN FL ELEVATOR EN FL POWER SUPPLY EN FL 72H SAMPLE SER EN PO OMNIMATE EN PO OMNIMATE EN

BL 3.50/06/90 SN OR BX

Weidmüller Interface GmbH & Co. KG
 Klingenbergstraße 26
 D-32758 Detmold
 Germany

www.weidmueller.com

Drawings

Product image

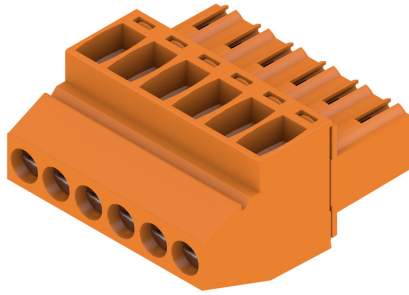

Dimensional drawing

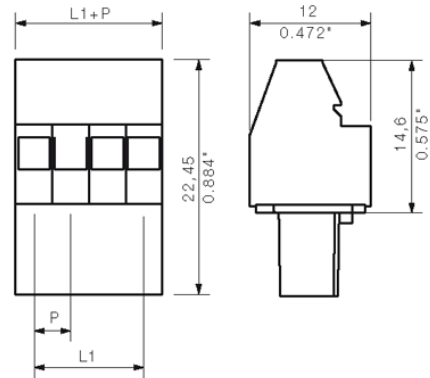

Graph

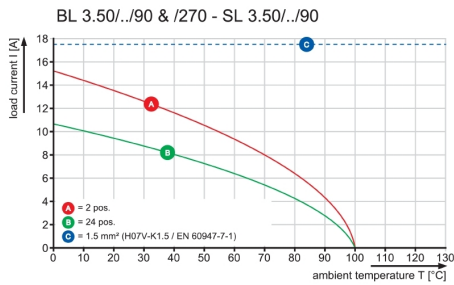

Graph

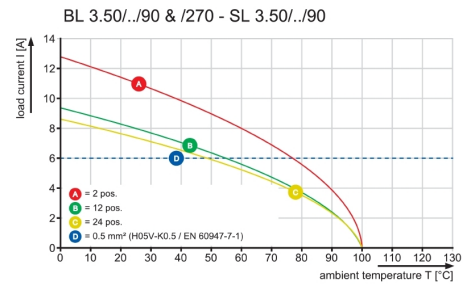

BL 3.50/06/90 SN OR BX

Weidmüller Interface GmbH & Co. KG
 Klingenbergstraße 26
 D-32758 Detmold
 Germany

www.weidmueller.com

Accessories
Coding elements

Only connects what is supposed to be connected: the right connection at the right place.

Coding elements and locking devices clearly assign connecting elements during the manufacturing process and operation

The coding elements and locking devices are inserted prior to assembly or during the cable assembly phase. The Weidmüller alternative: configure online using the variant configurator to precode prior to delivery.

Incorrect assembly on the circuit board and incorrect plugging of connecting elements is no longer possible. The advantage: no troubleshooting during manufacture and no operational errors by the user.

General ordering data

Type	BL SL 3.5 KO SW	Version	Product data	Packaging
Order No.	1610100000	PCB plug-in connector, Accessories, Coding element, black, Number		Box
GTIN (EAN)	4008190187637	of poles: 1		
Qty.	100 pc(s).			
Type	BL SL 3.5 KO OR	Version	Product data	Packaging
Order No.	1693430000	PCB plug-in connector, Accessories, Coding element, orange, Number		Box
GTIN (EAN)	4008190867447	of poles: 1		
Qty.	100 pc(s).			

WEITERGABE SOWIE Vervielfältigung dieses Dokuments, Verwertung und Mitteilung seines Inhalts sind verboten, soweit nicht ausdrücklich gestattet.
Zuwendungen verpflichtet zu Schadenersatz. Alle Rechte für den Fall der Patent-, Gebrauchsmuster- oder Geschmacksmustererhaltung vorbehalten.
THE REPRODUCTION, DISTRIBUTION AND UTILIZATION OF THIS DOCUMENT AS WELL AS THE COMMUNICATION OF ITS CONTENTS TO OTHERS WITHOUT EXPLICIT AUTHORIZATION IS PROHIBITED.
OFFENDERS WILL BE HELD LIABLE FOR THE PAYMENT OF DAMAGES. WEIDMUELLER EXCLUSIVELY RESERVES THE RIGHT TO FILE FOR PATENTS, UTILITY MODELS OR DESIGNS.

© WEIDMUELLER INTERFACE GmbH & Co. KG

For the mounting of PCBs, it should be noted that the rated data given in the catalogue relates only to the connection elements. The necessary creepage and clearance paths must be observed in connection with the respective applicant in accordance to VDE 0113. The current-carrying capacity and pitch tolerance must be determined according to DIN IEC 326 part 1.

Weidmüller connectors are tested to the DIN VDE 0113 standard, and are valid for its field of application. Provided that the components are used to their intended purpose, all requirements with respect to the occurrence of electrical, mechanical, thermal and corrosive stress will be satisfied.

X-ON Electronics

Largest Supplier of Electrical and Electronic Components

Click to view similar products for [Pluggable Terminal Blocks](#) category:

Click to view products by [Weidmuller](#) manufacturer:

Other Similar products are found below :

[57.510.0053](#) [MC 1.5/ 6-ST-3.5 GY AU](#) [ET02015000J0G](#) [734-104](#) [734-302](#) [8-141-P](#) [8426620000](#) [860505](#) [860516](#) [860810](#) [GBPACX-12](#)
[93.731.4953.0](#) [PV05-5,08-K](#) [PVP03-3,50](#) [PVP04-3,50](#) [PVS02-5,00](#) [1-1986160-3](#) [1377680000](#) [1531000000](#) [1546228-5](#) [ELFH16150](#)
[ELFP03110](#) [ELFP10210](#) [ELFT06250](#) [ELVP03100](#) [1700101](#) [1700410](#) [1700425](#) [1702246](#) [1705229](#) [1710175](#) [1714537](#) [1717806](#) [1719600](#)
[1728941](#) [1734692](#) [1734795](#) [1736036](#) [1740194](#) [1740628](#) [1740990](#) [1746952](#) [1750207](#) [1752441](#) [1752865](#) [1754115](#) [1754144](#) [1756913](#)
[1760051](#) [1760336](#)