

## LM 3.50/02/90 3.2SN OR BX

**Weidmüller Interface GmbH & Co. KG**  
 Klingenbergstraße 26  
 D-32758 Detmold  
 Germany

www.weidmueller.com

### Product image

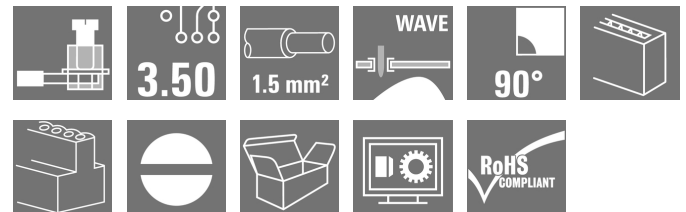

Similar to illustration

Small, compact PCB terminal or -tier PCB terminal with proven clamping yoke connection and 3.5 mm pitch. Suitable for conductor cross-sections up to 1.5 mm<sup>2</sup>.

### General ordering data

Version	Printed circuit board terminals, 3.50 mm, Number of poles: 2, 90°, Solder pin length (l): 3.2 mm, tinned, orange, Clamping yoke connection, Clamping range, max. : 2.08 mm <sup>2</sup> , Box
Order No.	<a href="#">1667750000</a>
Type	LM 3.50/02/90 3.2SN OR BX
GTIN (EAN)	4008 190425685
Qty.	100 pc(s).
Product data	IEC: 320 V / 16 A / 0.5 - 1.5 mm <sup>2</sup> UL: 300 V / 10 A / AWG 28 - AWG 14
Packaging	Box

Creation date January 14, 2022 2:13:01 AM CET

## LM 3.50/02/90 3.2SN OR BX

Weidmüller Interface GmbH &amp; Co. KG

Klingenbergstraße 26

D-32758 Detmold

Germany

www.weidmueller.com

## Technical data

## Dimensions and weights

Depth	8.3 mm	Depth (inches)	0.327 inch
Height	16 mm	Height (inches)	0.63 inch
Height of lowest version	12.8 mm	Width	7.6 mm
Width (inches)	0.299 inch	Net weight	1.15 g

## System parameters

Product family	OMNIMATE Signal - series LM	Wire connection method	Clamping yoke connection
Mounting onto the PCB	THT solder connection	Conductor outlet direction	90°
Pitch in mm (P)	3.5 mm	Pitch in inches (P)	0.138 inch
Number of poles	2	Pin series quantity	1
Fitted by customer	Yes	Max. adjacent poles per row	24
Solder pin length (l)	3.2 mm	Solder pin dimensions	1.0 x 0.6 mm
Solder eyelet hole diameter (D)	1.3 mm	Solder eyelet hole diameter tolerance (D)+	0, 1 mm
Number of solder pins per pole	1	Screwdriver blade	0.4 x 2.5
Screwdriver blade standard	DIN 5264	Tightening torque, min.	0.2 Nm
Tightening torque, max.	0.25 Nm	Clamping screw	M 2
Stripping length	5 mm	L1 in mm	3.5 mm
L1 in inches	0.138 inch	Touch-safe protection acc. to DIN VDE 0470	IP 20
Touch-safe protection acc. to DIN VDE 57 106	Safe from finger touch	Protection degree	IP20
Volume resistance	3.60 mΩ		

## Material data

Insulating material	PA	Colour	orange
Colour chart (similar)	RAL 2000	Insulating material group	I
Comparative Tracking Index (CTI)	≥ 600	Insulation strength	≥ 10 <sup>8</sup> Ω
UL 94 flammability rating	V-2	Contact material	Copper alloy
Contact surface	tinned	Coating	1-3 μm Ni, 4-6 μm SN
Tinning type	matt	Layer structure of solder connection	1.5...3 μm Ni / 4...6 μm Sn matt
Storage temperature, min.	-40 °C	Storage temperature, max.	70 °C
Operating temperature, min.	-50 °C	Operating temperature, max.	100 °C
Temperature range, installation, min.	-25 °C	Temperature range, installation, max.	100 °C

## Conductors suitable for connection

Clamping range, min.	0.08 mm <sup>2</sup>
Clamping range, max.	2.08 mm <sup>2</sup>
Wire connection cross section AWG, min.	AWG 28
Wire connection cross section AWG, max.	AWG 14
Solid, min. H05(07) V-U	0.5 mm <sup>2</sup>
Solid, max. H05(07) V-U	1.5 mm <sup>2</sup>
Flexible, min. H05(07) V-K	0.5 mm <sup>2</sup>
Flexible, max. H05(07) V-K	1.5 mm <sup>2</sup>
w. plastic collar ferrule, DIN 46228 pt 4, 0.5 mm <sup>2</sup> min.	
w. plastic collar ferrule, DIN 46228 pt 4, 0.75 mm <sup>2</sup> max.	
Plug gauge in accordance with EN 60999 a x b; ø	2.4 mm x 1.5 mm

Creation date January 14, 2022 2:13:01 AM CET

## LM 3.50/02/90 3.2SN OR BX

Weidmüller Interface GmbH &amp; Co. KG

Klingenbergstraße 26

D-32758 Detmold

Germany

www.weidmueller.com

## Technical data

Clampable conductor	Cross-section for conductor connection	Type	fine-wired
		nominal	0.75 mm <sup>2</sup>
	wire end ferrule	Stripping length	nominal
		Recommended wire-end ferrule	<a href="#">HO.75/12 W</a>

Reference text Length of ferrules is to be chosen depending on the product and the rated voltage., The outside diameter of the plastic collar should not be larger than the pitch (P)

## Rated data acc. to IEC

tested acc. to standard	IEC 60664-1, IEC 61984	Rated current, min. number of poles (Tu=20°C)	16 A
Rated current, max. number of poles (Tu=20°C)	12 A	Rated current, min. number of poles (Tu=40°C)	14 A
Rated current, max. number of poles (Tu=40°C)	10 A	Rated voltage for surge voltage class / pollution degree II/2	320 V
Rated voltage for surge voltage class / pollution degree III/2	160 V	Rated voltage for surge voltage class / pollution degree III/3	160 V
Rated impulse voltage for surge voltage class/ pollution degree II/2	2.5 kV	Rated impulse voltage for surge voltage class/ pollution degree III/2	2.5 kV
Rated impulse voltage for surge voltage class/ contamination degree III/3	2.5 kV	Short-time withstand current resistance	3 x 1s with 72 A

## Rated data acc. to CSA

Institute (CSA)		Certificate No. (CSA)	154685-1202192
Rated voltage (Use group B / CSA)	300 V	Rated voltage (Use group D / CSA)	300 V
Rated current (Use group B / CSA)	10 A	Rated current (Use group D / CSA)	10 A
Wire cross-section, AWG, min.	AWG 28	Wire cross-section, AWG, max.	AWG 14
Reference to approval values	Specifications are maximum values, details - see approval certificate.		

## Rated data acc. to UL 1059

Institute (UR)		Certificate No. (UR)	E60693
Rated voltage (Use group B / UL 1059)	300 V	Rated voltage (Use group D / UL 1059)	300 V
Rated current (Use group B / UL 1059)	10 A	Rated current (Use group D / UL 1059)	10 A
Wire cross-section, AWG, min.	AWG 28	Wire cross-section, AWG, max.	AWG 14
Reference to approval values	Specifications are maximum values, details - see approval certificate.		

## Packing

Packaging	Box	VPE length	89 mm
VPE width	70 mm	VPE height	42 mm

Creation date January 14, 2022 2:13:01 AM CET

Catalogue status 17.12.2021 / We reserve the right to make technical changes.

3

## LM 3.50/02/90 3.2SN OR BX

**Weidmüller Interface GmbH & Co. KG**  
 Klingenbergstraße 26  
 D-32758 Detmold  
 Germany

www.weidmueller.com

## Technical data

## Classifications

ETIM 6.0	EC002643	ETIM 7.0	EC002643
ETIM 8.0	EC002643	ECLASS 9.0	27-44-04-01
ECLASS 9.1	27-44-04-01	ECLASS 10.0	27-44-04-01
ECLASS 11.0	27-46-01-01		

## Important note

IPC conformity	Conformity: The products are developed, manufactured and delivered according international recognized standards and norms and comply with the assured properties in the data sheet resp. fulfill decorative properties in accordance with IPC-A-610 "Class 2". Further claims on the products can be evaluated on request.
Notes	<ul style="list-style-type: none"> <li>• Additional colours on request</li> <li>• Rated current related to rated cross-section &amp; min. No. of poles.</li> <li>• Max. outer diameter of the conductor: 2.9 mm</li> <li>• Wire end ferrule with plastic collar to DIN 46228/4</li> <li>• P on drawing = pitch</li> <li>• Rated data refer only to the component itself. Clearance and creepage distances to other components are to be designed in accordance with the relevant application standards.</li> <li>• It is necessary to hold the insulating body of the one or two pole terminal when tightening the screw</li> <li>• Long term storage of the product with average temperature of 50 °C and average humidity 70%, 36 months</li> </ul>

## Approvals

Approvals



ROHS	Conform
UL File Number Search	E60693

## LM 3.50/02/90 3.2SN OR BX

**Weidmüller Interface GmbH & Co. KG**  
Klingenbergstraße 26  
D-32758 Detmold  
Germany

[www.weidmueller.com](http://www.weidmueller.com)

# Technical data

## Downloads

Approval/Certificate/Document of Conformity	<a href="#">Declaration of the Manufacturer</a>
Engineering Data	<a href="#">CAD data – STEP</a>
Engineering Data	<a href="#">EPLAN, WSCAD, Zuken E3.S</a>
Catalogues	<a href="#">Catalogues in PDF-format</a>
Brochures	<a href="#">FL DRIVES EN</a> <a href="#">FL ANALO.SIGN.CONV. EN</a> <a href="#">MB DEVICE MANUF. EN</a> <a href="#">FL DRIVES DE</a> <a href="#">FL BUILDING SAFETY EN</a> <a href="#">FL APPL LED LIGHTING EN</a> <a href="#">FL INDUSTR.CONTROLS EN</a> <a href="#">FL MACHINE SAFETY EN</a> <a href="#">FL HEATING ELECTR EN</a> <a href="#">FL APPL INVERTER EN</a> <a href="#">FL_BASE_STATION_EN</a> <a href="#">FL ELEVATOR EN</a> <a href="#">FL POWER SUPPLY EN</a> <a href="#">FL 72H SAMPLE SER EN</a> <a href="#">PO OMNIMATE EN</a> <a href="#">PO OMNIMATE EN</a>

**LM 3.50/02/90 3.2SN OR BX**

**Weidmüller Interface GmbH & Co. KG**  
 Klingenbergstraße 26  
 D-32758 Detmold  
 Germany

www.weidmueller.com

**Drawings**

**Dimensional drawing**

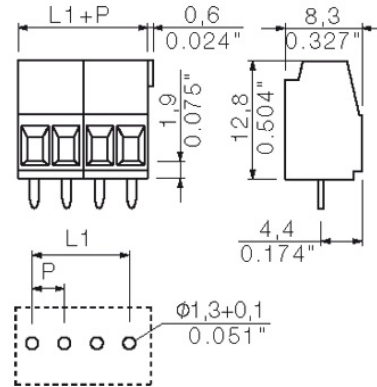

**Graph**

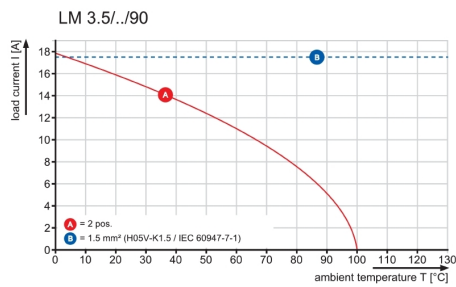

## LM 3.50/02/90 3.2SN OR BX

**Weidmüller Interface GmbH & Co. KG**  
 Klingenbergstraße 26  
 D-32758 Detmold  
 Germany

[www.weidmueller.com](http://www.weidmueller.com)

## Accessories

## Slotted screwdriver



Slotted screwdriver with rounded blade SD DIN 5265, ISO 2380/2, output to DIN 5264, ISO 2380/1. ChromTop tip, SoftFinish grip

## General ordering data

Type	SDS 0.4X2.5X75	Version
Order No.	<a href="#">9009030000</a>	Screwdriver, Screwdriver
GTIN (EAN)	4032248266944	
Qty.	1 pc(s).	

## Slotted screwdriver

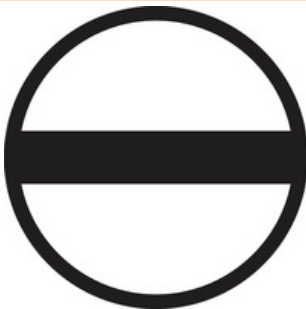

VDE insulated slot-head screwdriver, SDI DIN 7437, ISO 2380/2, drive output acc. to DIN 5264, ISO 2380/1. SoftFinish grip

## General ordering data

Type	SDIS 0.4X2.5X75	Version
Order No.	<a href="#">9008370000</a>	Screwdriver, Screwdriver
GTIN (EAN)	4032248056330	
Qty.	1 pc(s).	

## Recommended wave soldering profiles

**Weidmüller Interface GmbH & Co. KG**  
 Klingenbergstraße 16  
 D-32758 Detmold  
 Germany  
 Fon: +49 5231 14-0  
 Fax: +49 5231 14-292083  
 www.weidmueller.com

### Single Wave:

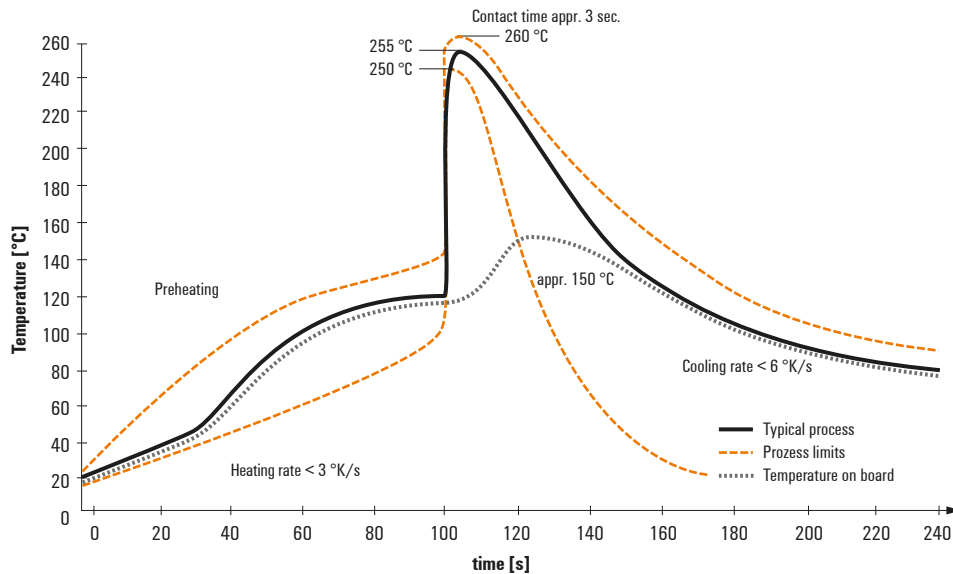

### Double Wave:

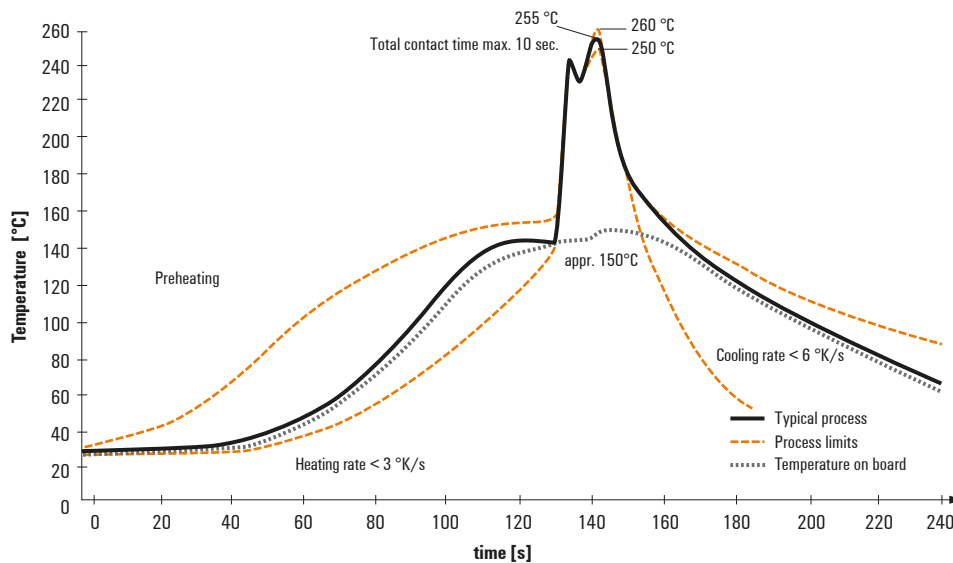

### Wave soldering profiles

Wired connection elements should be processed in accordance with the DIN EN 61760-1 standard. We have included two recommendations for practical wave soldering profiles, with which Weidmüller PCB terminals and connectors are qualified.

When choosing a suitable profile for your application, the following factors also need to be considered:

- PCB thickness
- Proportion of Cu in the layers
- Single/double-sided assembly
- Product range
- Heating and cooling rates

The single and double wave profiles each indicate the recommended operating range, including the maximum soldering temperature of 260°C. In practice, the maximum soldering temperature is quite often well below the above maximum profile.



## X-ON Electronics

Largest Supplier of Electrical and Electronic Components

*Click to view similar products for [Fixed Terminal Blocks](#) category:*

*Click to view products by [Weidmuller](#) manufacturer:*

Other Similar products are found below :

[MBE-1512](#) [MBE-154](#) [MBE-156](#) [MBES-153](#) [MBES-156](#) [MH-2512](#) [MHE-132](#) [MHE-163](#) [MI-254 \(35\)](#) [MI-272](#) [880507](#) [MPT-275](#)  
[15602-04-08-21](#) [ELM023100](#) [BA311TU](#) [BA411SU](#) [MV-152](#) [MV-252-D](#) [MV-253/NCNOC](#) [MV-254-D](#) [MV-255](#) [MV-462](#) [MV-493](#) [MVE-](#)  
[253](#) [MVE-273](#) [MVEB-153](#) [1700096](#) [1705142](#) [1712417](#) [1713020](#) [1713088](#) [1745195](#) [1760594](#) [1776118-2](#) [1790852](#) [1-796689-8](#) [1-796692-6](#)  
[1800001](#) [1800114](#) [1995279](#) [20020314-C121B01LF](#) [CB2-12](#) [KP03215000J0G](#) [KP04215000J0G](#) [S451](#) [282802-2](#) [29.007](#) [29.116](#) [30.103](#)  
[30.106](#)