

ZDK 1.5**Weidmüller Interface GmbH & Co. KG**

Klingenbergstraße 26

D-32758 Detmold

Germany

www.weidmueller.com

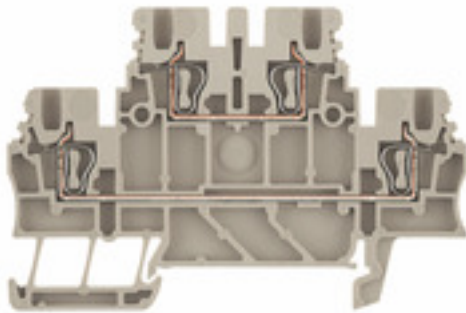
Product image**Spring connection with tension clamp Technology**

Tension clamp technology is a universal contact system for all common conductor connection types. Its fantastic level of flexibility makes the tension clamp a profitable alternative connection.

General ordering data

Version	Feed-through terminal, Double-tier terminal, Tension-clamp connection, 1.5 mm ² , 500 V, 17.5 A, dark beige
Order No.	1791100000
Type	ZDK 1.5
GTIN (EAN)	4032248239078
Qty.	100 pc(s).

Creation date January 13, 2022 5:23:14 PM CET

Catalogue status 17.12.2021 / We reserve the right to make technical changes.

ZDK 1.5**Weidmüller Interface GmbH & Co. KG**

Klingenbergstraße 26

D-32758 Detmold

Germany

www.weidmueller.com

Technical data**Dimensions and weights**

Depth	49.5 mm	Depth (inches)	1.949 inch
Depth including DIN rail	50 mm	Height	75.5 mm
Height (inches)	2.972 inch	Width	3.5 mm
Width (inches)	0.138 inch	Net weight	7.81 g

Temperatures

Storage temperature	-25 °C...55 °C	Continuous operating temp., min.	-50
Continuous operating temp., max.	120		

Material data

Material	Wemid	Colour	dark beige
UL 94 flammability rating	V-0		

System specifications

Version	Tension-clamp connection, for plug-in cross-connector, One end without connector	End cover plate required	Yes
Number of levels	2	Number of clamping points per level	2
Levels cross-connected internally	No	PE connection	No
Rail	TS 35		

Additional technical data

Explosion-tested version	No	Installation advice	Direct mounting
Number of similar terminals	1	Open sides	right
Type of mounting	Snap-on		

CSA rating data

Certificate No. (CSA)	154685-1461041	Current size C (CSA)	10 A
Voltage size C (CSA)	600 V	Wire cross section max. (CSA)	16 AWG
Wire cross section min. (CSA)	28 AWG		

Conductors for clamping (rated connection)

Blade size	0.4 x 2.0 mm		
Clamping range, max.	1.5 mm ²		
Clamping range, min.	0.05 mm ²		
Connection direction	top		
Gauge to IEC 60947-1	B1		
Number of connections	4		
Stripping length	10 mm		
Tube length for wire-end ferrule with plastic collar DIN 46228/4	Cross-section for conductor connection	nominal	0.5 mm ²
		min.	6 mm
		max.	10 mm
	Cross-section for conductor connection	nominal	0.75 mm ²
		min.	6 mm
		max.	12 mm
	Cross-section for conductor connection	nominal	1 mm ²
		min.	6 mm
		max.	12 mm

Creation date January 13, 2022 5:23:14 PM CET

ZDK 1.5

Weidmüller Interface GmbH & Co. KG
 Klingenbergstraße 26
 D-32758 Detmold
 Germany

www.weidmueller.com

Technical data

Tube length for wire-end ferrule without plastic collar DIN 46228/1	Cross-section for conductor connection	nominal	0.5 mm ²
		nominal	10 mm
	Cross-section for conductor connection	nominal	0.75 mm ²
		nominal	10 mm
	Cross-section for conductor connection	nominal	1 mm ²
		nominal	10 mm
	Cross-section for conductor connection	nominal	1.5 mm ²
		min.	10 mm
	max.	12 mm	
Twin wire-end ferrules, max.	0.75 mm ²		
Twin wire-end ferrules, min.	0.5 mm ²		
Type of connection	Tension-clamp connection		
Wire connection cross section AWG, max.	AWG 16		
Wire connection cross section AWG, min.	AWG 28		
Wire connection cross section, finely stranded, max.	1.5 mm ²		
Wire connection cross section, finely stranded, min.	0.5 mm ²		
Wire connection cross-section, finely stranded with wire-end ferrules DIN 46228/1, max.	1.5 mm ²		
Wire connection cross-section, finely stranded with wire-end ferrules DIN 46228/1, min.	0.5 mm ²		
Wire connection cross-section, finely stranded with wire-end ferrules DIN 46228/4, max.	1.5 mm ²		
Wire connection cross-section, finely stranded with wire-end ferrules DIN 46228/4, min.	0.5 mm ²		
Wire connection cross-section, solid core, max.	1.5 mm ²		
Wire connection cross-section, solid core, min.	0.5 mm ²		

General

Installation advice	Direct mounting	Rail	TS 35
Standards	IEC 60947-7-1	Wire connection cross section AWG, max.	AWG 16
Wire connection cross section AWG, min.	AWG 28		

Rating data

Rated cross-section	1.5 mm ²	Rated voltage	500 V
Rated current	17.5 A	Current at maximum wires	17.5 A
Standards	IEC 60947-7-1	Volume resistance according to IEC 60947-7-x	1.83 mΩ
Rated impulse withstand voltage	6 kV	Power loss in accordance with IEC 60947-7-x	0.56 W
Pollution severity	3		

ZDK 1.5

Weidmüller Interface GmbH & Co. KG
 Klingenbergstraße 26
 D-32758 Detmold
 Germany

www.weidmueller.com

Technical data**UL rating data**

Certificate No. (cURus)	E60693	Conductor size Factory wiring max. (cURus)	16 AWG
Conductor size Factory wiring min. (cURus)	28 AWG	Conductor size Field wiring max. (cURus)	16 AWG
Conductor size Field wiring min. (cURus)	28 AWG	Current size B (cURus)	10 A
Current size D (cURus)	10 A	Voltage size B (cURus)	300 V
Voltage size D (cURus)	300 V		

Classifications

ETIM 6.0	EC000897	ETIM 7.0	EC000897
ETIM 8.0	EC000897	ECLASS 9.0	27-14-11-20
ECLASS 9.1	27-14-11-20	ECLASS 10.0	27-14-11-20
ECLASS 11.0	27-14-11-20		

Approvals

Approvals



ROHS	Conform
UL File Number Search	E60693

Downloads

Approval/Certificate/Document of Conformity	EAC certificate CE Declaration of Conformity CE Declaration of Conformity all terminals
Engineering Data	CAD data – STEP
Engineering Data	EPLAN, WSCAD, Zuken E3.S
User Documentation	StorageConditionsTerminalBlocks
Catalogues	Catalogues in PDF-format
Brochures	

Data sheet

ZDK 1.5

Weidmüller Interface GmbH & Co. KG
Klingenbergstraße 26
D-32758 Detmold
Germany

www.weidmueller.com

Drawings

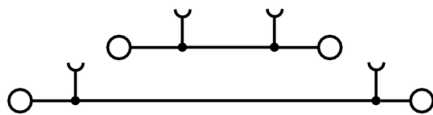

ZDK 1.5

Weidmüller Interface GmbH & Co. KG
 Klingenbergstraße 26
 D-32758 Detmold
 Germany

www.weidmueller.com

Accessories

Custom printing



The Dekafix (DEK) marker is the universal marker for all conductor and plug-in connectors as well as for electronic sub-assemblies. The system is ideal for short number sequences and covers a wide range of ready-printed markers.

Strips for fast installation in only one work step. The printing is easy to read, rich in contrast and available in various widths.

- Large range of ready-to-use markers
- Strips for fast installation
- Terminal markers, suitable for all Weidmüller cable connectors
- Available as blank MultiCard or with standard printing

For custom printing: Please send us a file of our labeling software M-Print PRO or M-Print PRO Online (without installation) for your labeling specifications.

General ordering data

Type	DEK 5/3.5 MC SDR	Version	
Order No.	1767730000		Dekafix, Terminal marker, 5 x 3.5 mm, Pitch in mm (P): 3.50
GTIN (EAN)	4032248102532		Weidmueller, To customer specification
Qty.	500 pc(s).		

ZDK 1.5

Weidmüller Interface GmbH & Co. KG
 Klingenbergstraße 26
 D-32758 Detmold
 Germany

www.weidmueller.com

Accessories

WS 12/3.5



WS/ DEK

MultiMark terminal markers use an innovative composite material made from two components. The hard base contour of the marker snaps securely into the connector. The elastic surface finish makes the marker easy to mount. This specially punched material enables the strips to be stretched to accommodate the slight variations in spacing that tend to add up, especially with long terminal blocks. Another advantage: the excellent printability of the surface material guarantees durable and wear-resistant labelling. A print resolution of 300 dpi also produces a very legible script.

Your benefits with MultiMark

- Firm hold and durable printing
- Continuous strips save installation time
- Easy mounting thanks to an innovative composite material
- Large label field for optimal legibility
- High flexibility thanks to manufacturer independence

General ordering data

Type	WS 12/3.5 MM WS	Version	
Order No.	2007180000	WS, Terminal marker, 12 x 3.5 mm, Weidmueller, white	
GTIN (EAN)	4050118392203		
Qty.	1,000 pc(s).		

ZDK 1.5

Weidmüller Interface GmbH & Co. KG
 Klingenbergstraße 26
 D-32758 Detmold
 Germany

www.weidmueller.com

Accessories

DEK 5/3.5



WS/ DEK

MultiMark terminal markers use an innovative composite material made from two components. The hard base contour of the marker snaps securely into the connector. The elastic surface finish makes the marker easy to mount. This specially punched material enables the strips to be stretched to accommodate the slight variations in spacing that tend to add up, especially with long terminal blocks. Another advantage: the excellent printability of the surface material guarantees durable and wear-resistant labelling. A print resolution of 300 dpi also produces a very legible script.

Your benefits with MultiMark

- Firm hold and durable printing
- Continuous strips save installation time
- Easy mounting thanks to an innovative composite material
- Large label field for optimal legibility
- High flexibility thanks to manufacturer independence

General ordering data

Type	DEK 5/3.5 MM WS	Version	
Order No.	2007100000	Dekafix, Terminal marker, 5 x 3.5 mm, Weidmueller, white	
GTIN (EAN)	4050118391992		
Qty.	1,000 pc(s).		

Z-Series

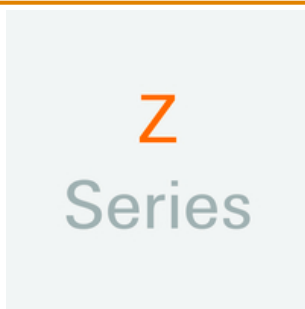

Test adapters and test plugs are used for the electrical connection between terminal blocks and the test equipment. In this way, an electrical contact can be established in the wired state and measurements can be done easily.

General ordering data

Type	ZTA 5	Version	
Order No.	1776210000	Accessories, Test adapter, 13.5 A	
GTIN (EAN)	4032248190676		
Qty.	25 pc(s).		
Type	ZTA 5/ZA	Version	
Order No.	1776220000	Accessories, Test adapter, 13.5 A	
GTIN (EAN)	4032248190683		
Qty.	25 pc(s).		

ZDK 1.5

Weidmüller Interface GmbH & Co. KG
 Klingenbergstraße 26
 D-32758 Detmold
 Germany

www.weidmueller.com

Accessories

Blank



WS markers are the perfect match for the W-series connectors. Thanks to their system compatibility, the WS tags can also be used with the I-series and the Z-series. The large marking surfaces do not only permit long character strings but also multi-line text. WS markers are ideal for labels with long, customised character strings. Thanks to the proven MultiCard format, printing with PrintJet CONNECT oder/or Plotter is possible.

- Can be fitted in strips or individually
- Markers in proven MultiCard format

For custom printing: Please send us a file of our labeling software M-Print PRO or M-Print PRO Online (without installation) for your labeling specifications.

General ordering data

Type	WS 12/3.5 MC NE WS	Version
Order No.	1778270000	WS, Terminal marker, 12 x 3.5 mm, Pitch in mm (P): 3.50
GTIN (EAN)	4032248161041	Weidmueller, Allen-Bradley, white
Qty.	600 pc(s).	

Z-Series

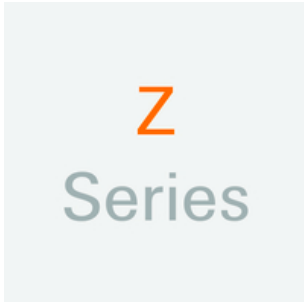

Weidmüller's range of products includes end brackets that guarantee a permanent, reliable mounting on the terminal rail and prevent sliding. Versions with and without screws are available. The end brackets include marking options, also for group markers, and also a test plug holder.

General ordering data

Type	ZEW 35/2	Version
Order No.	8630740000	Z-series, End bracket
GTIN (EAN)	4032248348916	
Qty.	20 pc(s).	
Type	ZEW 35	Version
Order No.	9540000000	Z-series, End bracket
GTIN (EAN)	4008190956264	
Qty.	20 pc(s).	

ZDK 1.5

Weidmüller Interface GmbH & Co. KG
 Klingenbergstraße 26
 D-32758 Detmold
 Germany

www.weidmueller.com

Accessories

Z-Series

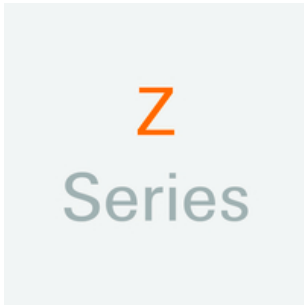

The use of reducing sleeves simplifies the connection of conductors with smaller cross-sections. Conductors can be reliably inserted into the clamping point without the strands fraying. The use of a reducing sleeve centres the conductor in the entry point.

General ordering data

Type	ZRH 1.5S/1	Version
Order No.	1781950000	Accessories, Reducing sleeve
GTIN (EAN)	4032248199525	
Qty.	500 pc(s).	

Z-Series

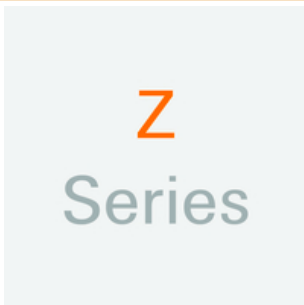

Warning covers with a flash symbol provide more safety for man and machine. They are used where external voltage must be indicated within the application.

General ordering data

Type	ZAD 7/4	Version
Order No.	1781940000	Z-series, Cover
GTIN (EAN)	4032248193431	
Qty.	20 pc(s).	

ZDK 1.5

Weidmüller Interface GmbH & Co. KG
 Klingenbergstraße 26
 D-32758 Detmold
 Germany

www.weidmueller.com

Accessories

Slotted screwdriver

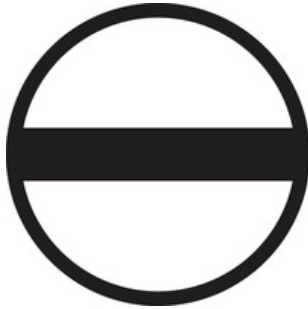

Slotted screwdriver with rounded blade SD DIN 5265, ISO 2380/2, output to DIN 5264, ISO 2380/1. ChromTop tip, SoftFinish grip

General ordering data

Type	SDS 0.4X2.0X60	Version
Order No.	2749260000	Screwdriver, Blade width (B): 2 mm, Blade length: 60 mm, Blade thickness (A): 0.4 mm
GTIN (EAN)	4050118895537	
Qty.	1 pc(s).	

W-Series



Weidmüller's range of products includes end brackets that guarantee a permanent, reliable mounting on the terminal rail and prevent sliding. Versions with and without screws are available. The end brackets include marking options, also for group markers, and also a test plug holder.

General ordering data

Type	WEW 35/1	Version
Order No.	1059000000	W-Series, End bracket
GTIN (EAN)	4008190172282	
Qty.	50 pc(s).	
Type	WEW 35/2	Version
Order No.	1061200000	W-Series, End bracket
GTIN (EAN)	4008190030230	
Qty.	50 pc(s).	

ZDK 1.5

Weidmüller Interface GmbH & Co. KG
 Klingenbergstraße 26
 D-32758 Detmold
 Germany

www.weidmueller.com

Accessories

SAK-Series



SAK Series

Weidmüller's range of products includes end brackets that guarantee a permanent, reliable mounting on the terminal rail and prevent sliding. Versions with and without screws are available. The end brackets include marking options, also for group markers, and also a test plug holder.

General ordering data

Type	EW 35	Version
Order No.	0383560000	Accessories, End bracket
GTIN (EAN)	4008190181314	
Qty.	50 pc(s).	
Type	EW 35 GR 7032	Version
Order No.	0383530000	Accessories, End bracket
GTIN (EAN)	4008190027322	
Qty.	50 pc(s).	
Type	EW 35/SCHA/M3	Version
Order No.	0258660000	Accessories, End bracket
GTIN (EAN)	4008190033477	
Qty.	20 pc(s).	

1.5 mm²

1.5 mm²

End plates are fitted to the open side of the last modular terminal before the end bracket. The use of an end plate ensures the function of the modular terminal and the specified rated voltage. It guarantees protection against contact with live parts and makes the final terminal finger-proof.

General ordering data

Type	ZAP/TW ZDK 1.5	Version
Order No.	1791160000	Z-series, End plate, Partition plate
GTIN (EAN)	4032248245260	
Qty.	20 pc(s).	

ZDK 1.5

Weidmüller Interface GmbH & Co. KG
 Klingenbergstraße 26
 D-32758 Detmold
 Germany

www.weidmueller.com

Accessories

STR transparent strips



General ordering data

Type	STR 7 F.SCHT 7	Version	
Order No.	0515300000	Terminal markers, Protective cap, 27 x 6.3 mm, Transparent	
GTIN (EAN)	4008190182175		
Qty.	20 pc(s).		

Blank



The Dekafix (DEK) marker is the universal marker for all conductor and plug-in connectors as well as for electronic sub-assemblies. The system is ideal for short number sequences and covers a wide range of ready-printed markers.

Strips for fast installation in only one work step. The printing is easy to read, rich in contrast and available in various widths.

- Large range of ready-to-use markers
- Strips for fast installation
- Terminal markers, suitable for all Weidmüller cable connectors
- Available as blank MultiCard or with standard printing

For custom printing: Please send us a file of our labeling software M-Print PRO or M-Print PRO Online (without installation) for your labeling specifications.

General ordering data

Type	DEK 5/3.5 MC NE WS	Version	
Order No.	1755270000	Dekafix, Terminal marker, 5 x 3.5 mm, Pitch in mm (P): 3.50	
GTIN (EAN)	4032248017348	Weidmueller, white	
Qty.	500 pc(s).		

ZDK 1.5

Weidmüller Interface GmbH & Co. KG
 Klingenbergstraße 26
 D-32758 Detmold
 Germany

www.weidmueller.com

Accessories
1.5 mm²

The plug-in cross-connections feature easy handling and quick installation. This saves a great deal of time during installation in comparison with screwed solutions.

General ordering data

Type	ZQV 1.5/2	Version
Order No.	1776120000	Accessories, Cross-connector, 17.5 A
GTIN (EAN)	4032248200139	
Qty.	60 pc(s).	
Type	ZQV 1.5/10	Version
Order No.	1776200000	Accessories, Cross-connector, 17.5 A
GTIN (EAN)	4032248200177	
Qty.	20 pc(s).	
Type	ZQV 1.5/4	Version
Order No.	1776140000	Accessories, Cross-connector, 17.5 A
GTIN (EAN)	4032248200160	
Qty.	60 pc(s).	
Type	ZQV 1.5/5	Version
Order No.	1776150000	Accessories, Cross-connector, 17.5 A
GTIN (EAN)	4032248236336	
Qty.	20 pc(s).	
Type	ZQV 1.5/3	Version
Order No.	1776130000	Accessories, Cross-connector, 17.5 A
GTIN (EAN)	4032248200153	
Qty.	60 pc(s).	

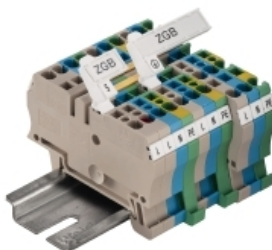
ZGB pivotable group tag holder

The ZGB 15 is a hinged group tag carrier. The tag carrier can hold the dekafix 5, WS 12/5 terminal markers or the inlay tag ESO 15.

The ZGB 30 is a hinged group tag carrier. The tag carrier can hold the dekafix 5, WS 12/5 terminal markers or the inlay tag ESO 7.

Inlay tags and protective strips can be found under "Accessories".

General ordering data

Type	ZGB 15	Version
Order No.	1636530000	Terminal markers, Terminal marker, 15 x 7 mm, Pitch in mm (P): 5.00
GTIN (EAN)	4008190297053	Weidmueller, white
Qty.	20 pc(s).	

Data sheet

ZDK 1.5

Weidmüller Interface GmbH & Co. KG
 Klingenbergstraße 26
 D-32758 Detmold
 Germany

www.weidmueller.com

Accessories

Type	ZGB 30/3.5	Version
Order No.	1778290000	Terminal markers, Terminal marker, 32 x 7 mm, Pitch in mm (P): 3.50
GTIN (EAN)	4032248161065	white
Qty.	20 pc(s).	
Type	ZGB 30	Version
Order No.	1611930000	Terminal markers, Terminal marker, 32 x 7 mm, Pitch in mm (P): 5.00
GTIN (EAN)	4008190002251	Weidmueller, white
Qty.	20 pc(s).	

X-ON Electronics

Largest Supplier of Electrical and Electronic Components

Click to view similar products for [DIN Rail Terminal Blocks](#) category:

Click to view products by [Weidmuller](#) manufacturer:

Other Similar products are found below :

[00110420202](#) [8WA1011-1BH23](#) [8WA1011-1EF20](#) [91.010](#) [9102100000](#) [91.040](#) [9123140000](#) [9123140001](#) [RBO 5-T-B-HEX](#) [1333564](#) [DP25-GY-ND](#) [1431306](#) [1433306](#) [HSL-TB64-DIN](#) [90.070](#) [91.020](#) [912314](#) [260-301_NR](#) [2757571](#) [280-331](#) [280-560](#) [280-564](#) [281-611/281-542](#) [281-673/281-411](#) [281-994](#) [283-317](#) [283-607](#) [2909798](#) [264-724](#) [264-726](#) [280-530](#) [280-555](#) [280-619](#) [281-610](#) [281-622/281-417](#) [284-317](#) [284-601](#) [2907033](#) [3048496](#) [5542152](#) [35956](#) [USK 10](#) [102510](#) [1025100000](#) [5520682](#) [5607102](#) [EMH 25-ZE30](#) [591620-2](#) [UM 45-SEFE](#) [M.NUT BK](#) [1-591651-1](#)