

**Technical  
data**

**You're striving towards new solutions  
We're presenting the best connections of 2017  
Let's connect.**



**Weidmüller** 

## Dear Customers,

The PDF versions of our catalogues offer practical additional functions, helping you to find your way around our product range and simplifying the ordering process.

In addition to the catalogue, the PDF also contains:

- Internal page links
- Links to the online catalogue

Try it out for yourself. Click the order number to obtain more detailed information and close-up images via you web browser. The links in the PDF file also enable you to go directly to the next desired catalogue page.

Further Weidmüller product catalogues can be accessed by clicking the following:





# News

## Highlights

### Connectivity



**T.48** **Safe supply for consumers in the panel**  
Klippon® Connect for optimum control voltage distribution

### Device Connectivity



**T.128** **Make your connections fit for the future**  
With the advanced solutions from RockStar® ModuPlug



**T.186** **Reliable and fast connection in power electronic applications**  
LLF 7.50 PCB terminal with PUSH IN connection system



## Connectivity



**T.9** **Fast wiring – but safe**  
Klippon® Connect for optimum wiring  
in confined spaces

**T.18** **Safety, protection and reliable  
disconnection of electrical circuits**  
Klippon® Connect combines protective  
functions and quick assembly

**T.38** **Reliable and efficient power supply**  
Really convenient with  
Klippon® Connect

**T.44** **The secure and efficient way of  
distributing power**  
Klippon® Connect provides the  
required flexibility

**T.46** **Clear wiring for high-density  
signalling levels**  
With Klippon® Connect in the smallest  
of spaces

### Electronics and automation



- T.62** **Load monitoring and potential distribution combined**  
maxGUARD – taking control voltage distribution to a new level
- T.84** **Complete transparency down to the sensor-actuator level**  
IO-Link Master for the easy integration of IO-Link devices
- T.85** **Increased failure prevention and functional and operational safety**  
Simultaneous support of two networks with u-remote Modbus TCP coupler
- T.86** **Increased ship automation performance**  
u-remote for shipbuilding, approved by classification societies
- T.87** **Individual system adaptation taken effortlessly into production**  
u-remote for unique flexible fieldbus architectures
- T.88** **Exact measurement of weight, torque and oscillation**  
Highly precise analysis of load cells with calibration function
- T.89** **Decentralised collection and forwarding of signals on the panel**  
u-remote Module in IP67: robust, versatile and flexible
- T.90** **Decentralised distribution of power in modular plant designs**  
FieldPower® with selective protection of system modules
- T.92** **Optimal retrofitting of energy management solutions**  
The new EM Connectivity Box is a flexible, complete solution
- T.94** **More transparency about quality parameters of electrical energy**  
Multi-functional power analyser powered by 24 V DC
- T.96** **Achieving the highest measurement accuracy in diverse applications**  
ACT20P PRO RTCI impresses with extremely simple configuration



**T.98** **Signal converters without auxiliary power supply**  
ACT20P products can be loop powered via input or output

**T.102** **Quick and reliable monitoring of limit values**  
ACT20P limit monitoring relays for a wide range of applications



**T.114** **Improve the profitability of photovoltaic systems**  
Customer-specific combiner box up to 1,500 V

**T.116** **Detects faults in photovoltaic systems in good time**  
String monitoring device for 1,500 V DC photovoltaic systems

**T.106** **Compact timing relay for easy adjustment of the control signals**  
IT-TIMER multi-functional timing relay with multi-voltage input

**T.118** **Replace PLC5 systems efficiently and without downtimes**  
Front adapter and pre-mounted cable for PLC migration

**T.108** **Installation of particularly compact and reliable connection solutions**  
BHF 5.00 PUSH IN for CH20M housings

**T.122** **Migrate IPC620 systems in the shortest time possible**  
Simple control system conversion with IPC620 carrier



**T.110** **Enhanced class II surge protection devices**  
VARITECTOR PU II for reliable protection in 230 V power supply networks

**T.112** **Solve simple instrumentation and control tasks economically**  
Robust logic units for process automation in harsh environments

**T.126** **Connect DCS and PLS systems quickly and reliably**  
Backplane systems for integrating electronic components

# News Overview

## Connectivity

**T.144** **Simple power wiring up to 16 A and 630 V AC**  
Pre-assembled M12 power cables in four codings: S, T, K and L



**T.152** **Access plants, processes and protection units more efficiently**  
FrontCom® Vario double frame provides more ports and a larger interface

**T.174** **Connection of 24 V DC power supply in harsh environments**  
PushPull Power connectors for PROFINET 24-V cabling



**T.176** **Lighting for control cabinets and devices in the field**  
Weidmüller Industry Light WIL

## Device Connectivity



**T.178** **Reliable and fast connection of power electronics devices**  
LUF and LUFS series PCB terminal with PUSH IN connection

## Tools

**T.188** **Easy conductor stripping and crimping in one work step**  
Electrically-driven stripping and crimping machine for standard applications

**T.190** **Convenient processing of large cross-sections**  
Handheld battery-operated hydraulic tools for crimping and cutting



**T.194** **Testing a wide range of system functions**  
Our instruments provide a helping hand with your electrical installation





## Marking system



**T.198** Custom-fit labelling for your individual needs  
Quick and reliable labelling with MultiMark heat shrink

## Service and support

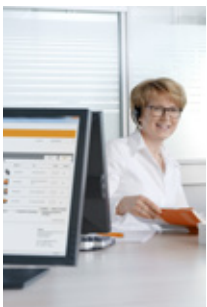

**T.204** Our expertise for your requirements  
Service connects - worldwide

**Experience the best connections of 2017  
online on our innovations platform:**

**[www.weidmueller.com/best-connections](http://www.weidmueller.com/best-connections)**

Here, you will find our new products in the application with detailed product benefits - also available for download.

If you prefer an overview in printed form, you can also order the catalogue here under the following order no.:

**2504960000**

**Let's connect.**

We constantly offer up-to-date ordering data and technical details on our full range of products at:  
**[catalog.weidmueller.com](http://catalog.weidmueller.com)**

Technical data

Machinery

Process

Energy

Transportation

Device Manufacturers

Infrastructure

**A2C 1.5**

1.5 mm<sup>2</sup>

**A3C 1.5**

1.5 mm<sup>2</sup>

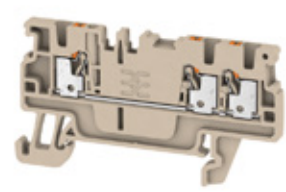
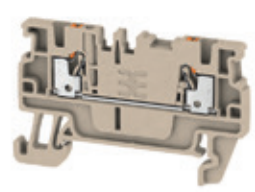

Width/Height/Depth	mm
max. current / max. cond. cross-section	A/mm <sup>2</sup>
Max. clamping range	mm <sup>2</sup>

3.5 x 55 x 45
<b>17.5 / 1.5</b>
<b>0.14...1.5</b>

3.5 x 61.5 x 45
<b>17.5 / 1.5</b>
<b>0.14...1.5</b>

**Technical data**

<b>Rated data</b>	
Rated voltage	V
Rated current	A
for wire cross-section	mm <sup>2</sup>
Rated impulse withstand voltage / Pollution severity	
Gauge to IEC 60947-1 / UL 94 flammability rating	
Approvals	
<b>Clamped conductors (H05V/H07V)</b>	
Solid / Stranded	mm <sup>2</sup>
Flexible / Flexible with ferrule	mm <sup>2</sup>
Stripping length / Blade size	mm/-
<b>Note</b>	

IEC 60947-7-1			
<b>IEC</b>	<b>UL</b>	<b>CSA</b>	<b>EN 60079-7</b>
500	300		
17.5	13		
1.5	AWG 26...14		
6 kV / 3			
A1 / V-0			
CE			
<b>Rated connection</b>			
0.5...1.5 / 0.5...1.5			
0.5...1.5 / 0.5...1.5			
8 / 0.4 x 2.0 mm			
Approval in progress			

IEC 60947-7-1			
<b>IEC</b>	<b>UL</b>	<b>CSA</b>	<b>EN 60079-7</b>
500	300		
17.5	13		
1.5	AWG 26...14		
6 kV / 3			
A1 / V-0			
<b>Rated connection</b>			
0.5...1.5 / 0.5...1.5			
0.5...1.5 / 0.5...1.5			
8 / 0.4 x 2.0 mm			
Approval in progress			

**Ordering data**

<b>Version</b>	
	dark beige
	blue
<b>Note</b>	

<b>Type</b>	<b>Qty.</b>	<b>Order No.</b>
A2C 1.5	100	<b>1552790000</b>
A2C 1.5 BL	100	<b>1552820000</b>

<b>Type</b>	<b>Qty.</b>	<b>Order No.</b>
A3C 1.5	50	<b>1552740000</b>
A3C 1.5 BL	50	<b>1552770000</b>

**Accessories**

<b>Pluggable cross-connection</b>	
	2-pole
	10-pole
	2-pole
	10-pole
<b>End plate</b>	
	dark beige
	Blue
<b>End bracket</b>	
	dark beige
	dark beige
<b>Test adapter</b>	
	1-pole
	stackable
	3-pole
	5-pole
<b>Test plug</b>	
<b>Screwdriver</b>	
	Standard
<b>Identification systems</b>	

<b>Type</b>	<b>current</b>	<b>Qty.</b>	<b>Order No.</b>
ZQV 1.5N/2	17.5 A	60	<b>1985410000</b>
ZQV 1.5N/10	17.5 A	20	<b>1985580000</b>
AEP 2C 1.5		50	<b>1552600000</b>
AEP 2C 1.5 BL		50	<b>1552610000</b>
AEB 35 SC/1		50	<b>1991920000</b>
ZEW 35		20	<b>9540000000</b>
ATPG 1.5-10 L		50	<b>1991890000</b>
ATPG 1.5 MHR		50	<b>1991880000</b>
PS 2.0 MC		20	<b>0310000000</b>
SDS 0.4X2.0X60		1	<b>9037160000</b>
WS 10/3.5 PLUS MC NE WS		960	<b>2003760000</b>
DEK 5/3.5 MM WS		1000	<b>2007100000</b>
WS 8/3.5 MM WS		1000	<b>2007140000</b>
DEK 5/3.5 PLUS MC NE WS		1600	<b>2003750000</b>

<b>Type</b>	<b>current</b>	<b>Qty.</b>	<b>Order No.</b>
ZQV 1.5N/2	17.5 A	60	<b>1985410000</b>
ZQV 1.5N/10	17.5 A	20	<b>1985580000</b>
AEP 3C 1.5		50	<b>1552620000</b>
AEP 3C 1.5 BL		50	<b>1552630000</b>
AEB 35 SC/1		50	<b>1991920000</b>
ZEW 35		20	<b>9540000000</b>
ATPG 1.5-10 L		50	<b>1991890000</b>
ATPG 1.5 MHR		50	<b>1991880000</b>
PS 2.0 MC		20	<b>0310000000</b>
SDS 0.4X2.0X60		1	<b>9037160000</b>
WS 10/3.5 PLUS MC NE WS		960	<b>2003760000</b>
DEK 5/3.5 MM WS		1000	<b>2007100000</b>
WS 8/3.5 MM WS		1000	<b>2007140000</b>
DEK 5/3.5 PLUS MC NE WS		1600	<b>2003750000</b>

For detailed information on other accessories and application in the online catalogue

All MultiMark variants (MM) = strip markers

All MultiMark variants (MM) = strip markers

**A4C 1.5**

**1.5 mm<sup>2</sup>**

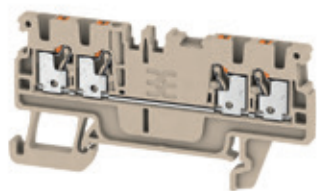

3.5 x 67.5 x 45  
**17.5 / 1.5**  
**0.14...1.5**



IEC 60947-7-1

IEC	UL	CSA	EN 60079-7
500	300		
17.5	13		
1.5	AWG 26...14		
6 kV / 3			
A1 / V-0			

CE

**Rated connection**

0.5...1.5 / 0.5...1.5  
 0.5...1.5 / 0.5...1.5  
 8 / 0.4 x 2.0 mm

Approval in progress

Type	Qty.	Order No.
A4C 1.5	100	1552690000
A4C 1.5 BL	100	1552700000

Type	current	Qty.	Order No.
ZQV 1.5N/2	17.5 A	60	1985410000
ZQV 1.5N/10	17.5 A	20	1985580000
AEP 4C 1.5		50	1552640000
AEP 4C 1.5 BL		50	1552650000
AEB 35 SC/1		50	1991920000
ZEW 35		20	9540000000
ATPG 1.5-10 L		50	1991890000
ATPG 1.5 MI-R		50	1991880000
PS 2.0 MC		20	0310000000
SDS 0.4x2.0x60		1	9037160000
WS 10/3.5 PLUS MC NE WS		960	2003760000
DEK 5/3.5 MM WS		1000	2007100000
WS 8/3.5 MM WS		1000	2007140000
DEK 5/3.5 PLUS MC NE WS		1600	2003750000

All MultiMark variants (MM) = strip markers

**A2C 2.5**

**2.5 mm<sup>2</sup>**

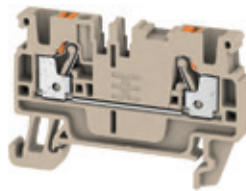

5.1 x 55 x 36.5  
**24 / 2.5**  
**0.14...2.5**



IEC 60947-7-1

IEC	UL	CSA	EN 60079-7
800	600	600	
24	20	20	
2.5	AWG 28...12	AWG 28...12	
8 kV / 3			
A3 / V-0			

CE

**Rated connection**

0.5...2.5 / 0.5...2.5  
 0.5...2.5 / 0.5...2.5  
 10 / 0.6 x 3.5 mm

Approval in progress

Type	Qty.	Order No.
A2C 2.5	100	1521850000
A2C 2.5 BL	100	1521880000

Type	current	Qty.	Order No.
ZQV 2.5N/2	24 A	60	1527540000
ZQV 2.5N/10	24 A	20	1527690000
AEP 2C 2.5		50	1514400000
AEP 2C 2.5 BL		50	1514420000
AEB 35 SC/1		50	1991920000
ZEW 35		20	9540000000
ATPG 1.5-10 L		50	1991890000
ATPG 2.5 MI-R		50	1991960000
ATPG 2.5/3		25	2041190000
ATPG 2.5/5		25	2041180000
PS 2.0 MC		20	0310000000
SDIL 0.6x3.5x100		1	9042110000
DEK 5/5 PLUS MC NE WS		1000	1854490000
DEK 5/5 MM WS		800	2007110000
WS 8/5 MM WS		800	2007150000
WS 10/5 M PLUS MC NE WS		600	2003770000

All MultiMark variants (MM) = strip markers

**A3C 2.5**

**2.5 mm<sup>2</sup>**

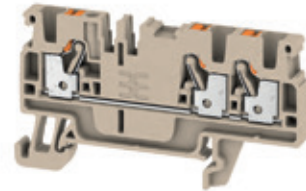

5.1 x 66.5 x 36.5  
**24 / 2.5**  
**0.14...2.5**



IEC 60947-7-1

IEC	UL	CSA	EN 60079-7
800	600	600	
24	20	20	
2.5	AWG 28...12	AWG 28...12	
8 kV / 3			
A3 / V-0			

CE

**Rated connection**

0.5...2.5 / 0.5...2.5  
 0.5...2.5 / 0.5...2.5  
 10 / 0.6 x 3.5 mm

Approval in progress

Type	Qty.	Order No.
A3C 2.5	100	1521740000
A3C 2.5 BL	100	1521780000

Type	current	Qty.	Order No.
ZQV 2.5N/2	24 A	60	1527540000
ZQV 2.5N/10	24 A	20	1527690000
AEP 3C 2.5		50	1521510000
AEP 3C 2.5 BL		50	1521520000
AEB 35 SC/1		50	1991920000
ZEW 35		20	9540000000
ATPG 1.5-10 L		50	1991890000
ATPG 2.5 MI-R		50	1991960000
ATPG 2.5/3		25	2041190000
ATPG 2.5/5		25	2041180000
PS 2.0 MC		20	0310000000
SDIL 0.6x3.5x100		1	9042110000
DEK 5/5 PLUS MC NE WS		1000	1854490000
DEK 5/5 MM WS		800	2007110000
WS 8/5 MM WS		800	2007150000
WS 10/5 M PLUS MC NE WS		600	2003770000

All MultiMark variants (MM) = strip markers

Technical data

Machinery

Process

Energy

Transportation

Device Manufacturers

Infrastructure

**A4C 2.5**

**2.5 mm<sup>2</sup>**

**A2C 4**

**4 mm<sup>2</sup>**

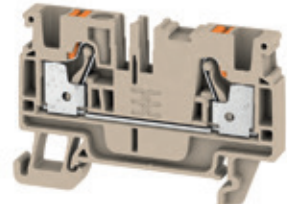
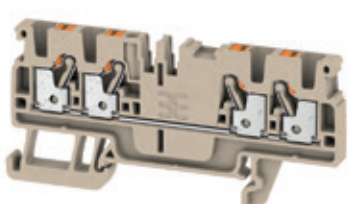

Width/Height/Depth	mm
max. current / max. cond. cross-section	A/mm <sup>2</sup>
Max. clamping range	mm <sup>2</sup>

5.1 x 77.5 x 36.5	
<b>24 / 2.5</b>	
<b>0.14...2.5</b>	

6.1 x 60 x 39.5	
<b>32 / 4</b>	
<b>0.5...4</b>	

**Technical data**

<b>Rated data</b>	
Rated voltage	V
Rated current	A
for wire cross-section	mm <sup>2</sup>
Rated impulse withstand voltage / Pollution severity	
Gauge to IEC 60947-1 / UL 94 flammability rating	
Approvals	
<b>Clamped conductors (H05V/H07V)</b>	
Solid / Stranded	mm <sup>2</sup>
Flexible / Flexible with ferrule	mm <sup>2</sup>
Stripping length / Blade size	mm/-
<b>Note</b>	

IEC 60947-7-1			
IEC	UL	CSA	EN 60079-7
800	600	600	
24	20	20	
2.5	AWG 28...12	AWG 28...12	
8 kV / 3			
A3 / V-0			
CE e-PA (UL) (CSA) (EN)			
<b>Rated connection</b>			
0.5...2.5 / 0.5...2.5			
0.5...2.5 / 0.5...2.5			
10 / 0.6 x 3.5 mm			
Approval in progress			

IEC 60947-7-1			
IEC	UL	CSA	EN 60079-7
800	600	600	
32	30	30	
4	AWG 28...10	AWG 26...10	
8 kV / 3			
A4 / V-0			
CE e-PA (UL) (CSA) (EN)			
<b>Rated connection</b>			
0.5...4 / 0.5...4			
0.5...4 / 0.5...4			
12 / 0.6 x 3.5 mm			
Approval in progress			

**Ordering data**

<b>Version</b>	dark beige
	blue
<b>Note</b>	

Type	Qty.	Order No.
A4C 2.5	100	1521690000
A4C 2.5 BL	100	1521700000

Type	Qty.	Order No.
A2C 4	100	2051180000
A2C 4 BL	100	2051210000

**Accessories**

<b>Pluggable cross-connection</b>	
	2-pole
	10-pole
	2-pole
	10-pole
<b>End plate</b>	
	dark beige
	Blue
<b>End bracket</b>	
	dark beige
	dark beige
<b>Test adapter</b>	
	1-pole
	stackable
	3-pole
	5-pole
<b>Test plug</b>	
<b>Screwdriver</b>	
	Standard
<b>Identification systems</b>	

Type	current	Qty.	Order No.
ZQV 2.5N/2	24 A	60	1527540000
ZQV 2.5N/10	24 A	20	1527690000
<b>End plate</b>			
AEP 4C 2.5		50	1521530000
AEP 4C 2.5 BL		50	1521640000
<b>End bracket</b>			
AEB 35 SC/1		50	1991920000
ZEW 35		20	9540000000
<b>Test adapter</b>			
ATPG 1.5-10 L		50	1991890000
ATPG 2.5 MHR		50	1991960000
ATPG 2.5/3		25	2041190000
ATPG 2.5/5		25	2041180000
<b>Test plug</b>			
PS 2.0 MC		20	0310000000
<b>Screwdriver</b>			
SDIL 0,6x3,5x100		1	9042110000
<b>Identification systems</b>			
DEK 5/5 PLUS MC NE WS		1000	1854490000
DEK 5/5 MM WS		800	2007110000
WS 8/5 MM WS		800	2007150000
WS 10/5 M PLUS MC NE WS		600	2003770000

Type	current	Qty.	Order No.
ZQV 4N/2	32 A	60	1527930000
ZQV 4N/10	32 A	20	1528090000
<b>End plate</b>			
AEP 2C 4		50	2051680000
AEP 2C 4 BL		50	2051690000
<b>End bracket</b>			
AEB 35 SC/1		50	1991920000
ZEW 35		20	9540000000
<b>Test adapter</b>			
ATPG 1.5-10 L		50	1991890000
ATPG 4 MHR		50	1991860000
<b>Test plug</b>			
PS 2.0 MC		20	0310000000
<b>Screwdriver</b>			
SDIL 0,6x3,5x100		1	9042110000
<b>Identification systems</b>			
WS 10/6 M PLUS MC NE WS		600	2003780000
DEK 5/6 MM WS		600	2007120000
WS 8/6 MM WS		600	2007160000
DEK 5/6 PLUS MC NE WS		1000	1011320000

For detailed information on other accessories and application in the online catalogue

All MultiMark variants (MM) = strip markers

All MultiMark variants (MM) = strip markers

**A3C 4**

**4 mm<sup>2</sup>**

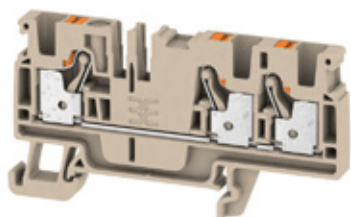

6.1 x 74 x 39.5  
**32 / 4**  
**0.5...4**



IEC 60947-7-1

IEC	UL	CSA	EN 60079-7
800	600	600	
32	30	30	
4	AWG 28...10	AWG 26...10	
8 kV / 3			
A4 / V-0			

CE

**Rated connection**

0.5...4 / 0.5...4  
 0.5...4 / 0.5...4  
 12 / 0.6 x 3.5 mm

Approval in progress

Type	Qty.	Order No.
A3C 4	50	2051240000
A3C 4 BL	50	2051280000

Type	current	Qty.	Order No.
ZQV 4N/2	32 A	60	1527930000
ZQV 4N/10	32 A	20	1528090000
AEP 3C 4		20	2051720000
AEP 3C 4 BL		20	2051880000
AEB 35 SC/1		50	1991920000
ZEW 35		20	9540000000
ATPG 1.5-10 L		50	1991890000
ATPG 4 MHR		50	1991860000
PS 2.0 MC		20	0310000000
SDIL 0,6x3,5x100		1	9042110000
WS 10/6 M PLUS MC NE WS		600	2003780000
DEK 5/6 MM WS		600	2007120000
WS 8/6 MM WS		600	2007160000
DEK 5/6 PLUS MC NE WS		1000	1011320000

All MultiMark variants (MM) = strip markers

**A4C 4**

**4 mm<sup>2</sup>**

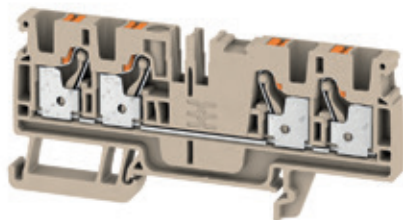

6.1 x 87.5 x 39.5  
**32 / 4**  
**0.5...4**

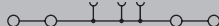

IEC 60947-7-1

IEC	UL	CSA	EN 60079-7
800	600	600	
32	30	30	
4	AWG 28...10	AWG 26...10	
8 kV / 3			
A4 / V-0			

CE

**Rated connection**

0.5...4 / 0.5...4  
 0.5...4 / 0.5...4  
 12 / 0.6 x 3.5 mm

Approval in progress

Type	Qty.	Order No.
A4C 4	50	2051500000
A4C 4 BL	50	2051520000

Type	current	Qty.	Order No.
ZQV 4N/2	32 A	60	1527930000
ZQV 4N/10	32 A	20	1528090000
AEP 4C 4		20	2051900000
AEP 4C 4 BL		20	2051910000
AEB 35 SC/1		50	1991920000
ZEW 35		20	9540000000
ATPG 1.5-10 L		50	1991890000
ATPG 4 MHR		50	1991860000
PS 2.0 MC		20	0310000000
SDIL 0,6x3,5x100		1	9042110000
WS 10/6 M PLUS MC NE WS		600	2003780000
DEK 5/6 MM WS		600	2007120000
WS 8/6 MM WS		600	2007160000
DEK 5/6 PLUS MC NE WS		1000	1011320000

All MultiMark variants (MM) = strip markers

Technical data

Machinery

Process

Energy

Transportation

Device Manufacturers

Infrastructure

**A2C 6**

6 mm<sup>2</sup>

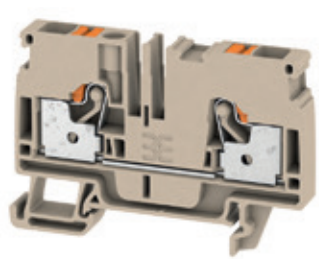

**A3C 6**

6 mm<sup>2</sup>

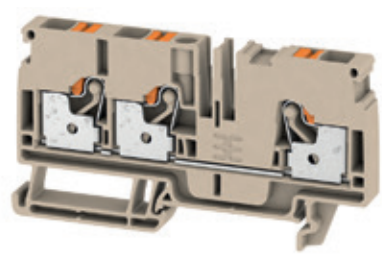

Width/Height/Depth	mm
max. current / max. cond. cross-section	A/mm <sup>2</sup>
Max. clamping range	mm <sup>2</sup>

8.1 x 66.5 x 45.5
<b>41 / 6</b>
<b>0.5...6</b>

8.1 x 84.5 x 45.5
<b>41 / 6</b>
<b>0.5...6</b>

**Technical data**

<b>Rated data</b>	
Rated voltage	V
Rated current	A
for wire cross-section	mm <sup>2</sup>
Rated impulse withstand voltage / Pollution severity	
Gauge to IEC 60947-1 / UL 94 flammability rating	
Approvals	
<b>Clamped conductors (H05V/H07V)</b>	
Solid / Stranded	mm <sup>2</sup>
Flexible / Flexible with ferrule	mm <sup>2</sup>
Stripping length / Blade size	mm/-
<b>Note</b>	

IEC 60947-7-1			
<b>IEC</b>	<b>UL</b>	<b>CSA</b>	<b>EN 60079-7</b>
800	600	600	
41	38	38	
6	AWG 22...8	AWG 22...8	
8 kV / 3			
A5 / V-0			
CE			
<b>Rated connection</b>			
0.5...6 / 0.5...6			
0.5...6 / 0.5...6			
12 / 1.0 x 5.5 mm			
Approval in progress			

IEC 60947-7-1			
<b>IEC</b>	<b>UL</b>	<b>CSA</b>	<b>EN 60079-7</b>
800	600	600	
41	38	38	
6	AWG 22...8	AWG 22...8	
8 kV / 3			
A5 / V-0			
CE			
<b>Rated connection</b>			
0.5...6 / 0.5...6			
0.5...6 / 0.5...6			
12 / 1.0 x 5.5 mm			
Approval in progress			

**Ordering data**

<b>Version</b>	
	dark beige
	blue
<b>Note</b>	

<b>Type</b>	<b>Qty.</b>	<b>Order No.</b>
A2C 6	50	<b>1992110000</b>
A2C 6 BL	50	<b>1991790000</b>

<b>Type</b>	<b>Qty.</b>	<b>Order No.</b>
A3C 6	50	<b>1991820000</b>
A3C 6 BL	50	<b>1991830000</b>

**Accessories**

<b>Pluggable cross-connection</b>	
	2-pole
<b>End plate</b>	
	dark beige
	Blue
<b>End bracket</b>	
	dark beige
	dark beige
<b>Test adapter</b>	
	1-pole
	stackable
<b>Test plug</b>	
<b>Screwdriver</b>	Standard
<b>Identification systems</b>	

<b>Type</b>	<b>current</b>	<b>Qty.</b>	<b>Order No.</b>
ZQV 6N/2	41 A	60	<b>1985740000</b>
AEP 2C 6		50	<b>1991970000</b>
AEP 2C 6 BL		50	<b>1991950000</b>
AEB 35 SC/1		50	<b>1991920000</b>
ZEW 35		20	<b>9540000000</b>
ATPG 1.5-10 L		50	<b>1991890000</b>
ATPG 6 M-R		50	<b>1991930000</b>
PS 2.0 MC		20	<b>0310000000</b>
SDIL 1,0x5,5x125		1	<b>9042130000</b>
DEK-A 5/8 MM WS		500	<b>2448860000</b>
WS-A 8/8 MM WS		500	<b>2448930000</b>
DEK 5/8 PLUS MC NE WS		800	<b>1046350000</b>
WS 10/8 PLUS MC NE WS		420	<b>1905950000</b>

<b>Type</b>	<b>current</b>	<b>Qty.</b>	<b>Order No.</b>
ZQV 6N/2	41 A	60	<b>1985740000</b>
AEP 3C 6		50	<b>1991940000</b>
AEP 3C 6 BL		20	<b>1991910000</b>
AEB 35 SC/1		50	<b>1991920000</b>
ZEW 35		20	<b>9540000000</b>
ATPG 1.5-10 L		50	<b>1991890000</b>
ATPG 6 M-R		50	<b>1991930000</b>
PS 2.0 MC		20	<b>0310000000</b>
SDIL 1,0x5,5x125		1	<b>9042130000</b>
DEK-A 5/8 MM WS		500	<b>2448860000</b>
WS-A 8/8 MM WS		500	<b>2448930000</b>
DEK 5/8 PLUS MC NE WS		800	<b>1046350000</b>
WS 10/8 PLUS MC NE WS		420	<b>1905950000</b>

For detailed information on other accessories and application in the online catalogue

All MultiMark variants (MM) = strip markers

All MultiMark variants (MM) = strip markers

ALO 6

6 mm<sup>2</sup>



Width/Height/Depth	mm
max. current / max. cond. cross-section	A/mm <sup>2</sup>
Max. clamping range	mm <sup>2</sup>

9 x 77 x 45.5
<b>41 / 6</b>
<b>0.5...6</b>



**Technical data**

Rated data	
Rated voltage	V
Rated current	A
for wire cross-section	mm <sup>2</sup>
Rated impulse withstand voltage / Pollution severity	
Gauge to IEC 60947-1 / UL 94 flammability rating	
Approvals	
Clamped conductors (H05V/H07V)	
Solid / Stranded	mm <sup>2</sup>
Flexible / Flexible with ferrule	mm <sup>2</sup>
Stripping length / Blade size	mm/-
Note	

IEC 60947-7-1

IEC	UL	CSA	EN 60079-7
800	600	600	
41	38	38	
6	AWG 22...8	AWG 22...8	
8 kV / 3			
A5 / V-0			

CE

Rated connection	
0.5...6 / 0.5...6	
0.5...6 / 0.5...6	
12 / 1.0 x 5.5 mm	

Approval in progress

**Ordering data**

Version	
	dark beige
	blue
Note	

Type	Qty.	Order No.
ALO 6	20	1991780000
ALO 6 BL	20	2065120000

**Accessories**

Pluggable cross-connection	
	2-pole
	10-pole
	2-pole
	10-pole
End bracket	
	dark beige
	dark beige
Test adapter	
	1-pole
Test plug	
Screwdriver	
	Standard
Identification systems	

Type	current	Qty.	Order No.
ZQV 1.5N/2	17.5 A	60	1985410000
ZQV 1.5N/10	17.5 A	20	1985580000
ZQV 2.5N/2	24 A	60	1527540000
ZQV 2.5N/10	24 A	20	1527690000
End bracket			
AEB 35 SC/1		50	1991920000
ZEW 35		20	9540000000
Test adapter			
ATPG 1.5-10 L		50	1991890000
Test plug			
PS 2.0 MC		20	0310000000
Screwdriver			
SDIL 1,0x5,5x125		1	9042130000
Identification systems			
WS 7.8/9.2 PLUS MC NE GR		360	1208970000

For detailed information on other accessories and application in the online catalogue

All MultiMark variants (MM) = strip markers



Technical data

Machinery

Process

Energy

Transportation

Device Manufacturers

Infrastructure

**A2T 2.5**

**2.5 mm<sup>2</sup>**

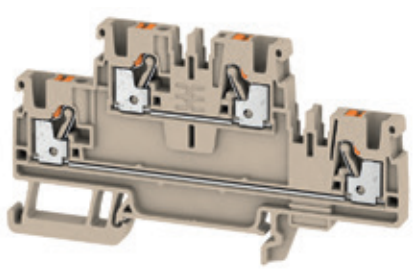

Width/Height/Depth	5.1 x 90 x 50.5
max. current / max. cond. cross-section	<b>24 / 2.5</b>
Max. clamping range	<b>0.14...2.5</b>



**A2T 2.5 VL**

**2.5 mm<sup>2</sup>**

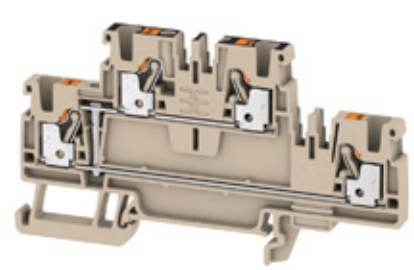

Width/Height/Depth	5.1 x 90 x 50.5
max. current / max. cond. cross-section	<b>24 / 2.5</b>
Max. clamping range	<b>0.14...2.5</b>

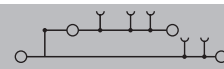

Width/Height/Depth	mm
max. current / max. cond. cross-section	A/mm <sup>2</sup>
Max. clamping range	mm <sup>2</sup>

**Technical data**

<b>Rated data</b>	
Rated voltage	V
Rated current	A
for wire cross-section	mm <sup>2</sup>
Rated impulse withstand voltage / Pollution severity	
Gauge to IEC 60947-1 / UL 94 flammability rating	
Approvals	
<b>Clamped conductors (H05V/H07V)</b>	
Solid / Stranded	mm <sup>2</sup>
Flexible / Flexible with ferrule	mm <sup>2</sup>
Stripping length / Blade size	mm/-
<b>Note</b>	

IEC 60947-7-1			
<b>IEC</b>	<b>UL</b>	<b>CSA</b>	<b>EN 60079-7</b>
800	600	600	
24	20	20	
2.5	AWG 28...12	AWG 28...12	
8 kV / 3			
A3 / V-0			
CE CB e-PA (A) M			
<b>Rated connection</b>			
0.5...2.5 / 0.5...2.5			
0.5...2.5 / 0.5...2.5			
10 / 0.6 x 3.5 mm			
Approval in progress			

IEC 60947-7-1			
<b>IEC</b>	<b>UL</b>	<b>CSA</b>	<b>EN 60079-7</b>
800	600	600	
24	20	20	
2.5	AWG 28...12	AWG 28...12	
8 kV / 3			
A3 / V-0			
CE CB e-PA (A) M			
<b>Rated connection</b>			
0.5...2.5 / 0.5...2.5			
0.5...2.5 / 0.5...2.5			
10 / 0.6 x 3.5 mm			
Approval in progress			

**Ordering data**

<b>Version</b>	dark beige
	blue
<b>Note</b>	

<b>Type</b>	<b>Qty.</b>	<b>Order No.</b>
A2T 2.5	50	<b>1547610000</b>
A2T 2.5 BL	50	<b>1547620000</b>

<b>Type</b>	<b>Qty.</b>	<b>Order No.</b>
A2T 2.5 VL	50	<b>1547650000</b>
A2T 2.5 VL BL	50	<b>1547660000</b>

**Accessories**

<b>Pluggable cross-connection</b>	
	2-pole
	10-pole
<b>End plate</b>	
	dark beige
	blue
<b>End bracket</b>	
	dark beige
	dark beige
<b>Test adapter</b>	
	1-pole
	stackable
	3-pole
	5-pole
<b>Test plug</b>	
<b>Screwdriver</b>	
	Standard
<b>Identification systems</b>	

<b>Type</b>	<b>current</b>	<b>Qty.</b>	<b>Order No.</b>
ZQV 2.5N/2	24 A	60	<b>1527540000</b>
ZQV 2.5N/10	24 A	20	<b>1527690000</b>
<b>End plate</b>			
AEP 2T 2.5		20	<b>1547690000</b>
AEP 2T 2.5 BL		20	<b>1547700000</b>
<b>End bracket</b>			
AEB 35 SC/1		50	<b>1991920000</b>
ZEW 35/2		20	<b>8630740000</b>
<b>Test adapter</b>			
ATPG 1.5-10 L		50	<b>1991890000</b>
ATPG 2.5 MHR		50	<b>1991960000</b>
ATPG 2.5/3		25	<b>2041190000</b>
ATPG 2.5/5		25	<b>2041180000</b>
<b>Test plug</b>			
PS 2.0 MC		20	<b>0310000000</b>
<b>Screwdriver</b>			
SDIL 0,6x3,5x100		1	<b>9042110000</b>
<b>Identification systems</b>			
DEK 5/5 PLUS MC NE WS		1000	<b>1854490000</b>
DEK 5/5 MM WS		800	<b>2007110000</b>
WS 8/5 MM WS		800	<b>2007150000</b>
WS 10/5 M PLUS MC NE WS		600	<b>2003770000</b>
SNAPMARK I		50	<b>1805880000</b>

<b>Type</b>	<b>current</b>	<b>Qty.</b>	<b>Order No.</b>
ZQV 2.5N/2	24 A	60	<b>1527540000</b>
ZQV 2.5N/10	24 A	20	<b>1527690000</b>
<b>End plate</b>			
AEP 2T 2.5		20	<b>1547690000</b>
AEP 2T 2.5 BL		20	<b>1547700000</b>
<b>End bracket</b>			
AEB 35 SC/1		50	<b>1991920000</b>
ZEW 35/2		20	<b>8630740000</b>
<b>Test adapter</b>			
ATPG 1.5-10 L		50	<b>1991890000</b>
ATPG 2.5 MHR		50	<b>1991960000</b>
ATPG 2.5/3		25	<b>2041190000</b>
ATPG 2.5/5		25	<b>2041180000</b>
<b>Test plug</b>			
PS 2.0 MC		20	<b>0310000000</b>
<b>Screwdriver</b>			
SDIL 0,6x3,5x100		1	<b>9042110000</b>
<b>Identification systems</b>			
DEK 5/5 PLUS MC NE WS		1000	<b>1854490000</b>
DEK 5/5 MM WS		800	<b>2007110000</b>
WS 8/5 MM WS		800	<b>2007150000</b>
WS 10/5 M PLUS MC NE WS		600	<b>2003770000</b>
SNAPMARK I		50	<b>1805880000</b>

For detailed information on other accessories and application in the online catalogue

All MultiMark variants (MM) = strip markers

All MultiMark variants (MM) = strip markers



**A2T 2.5 FT-PE**

**2.5 mm<sup>2</sup>**

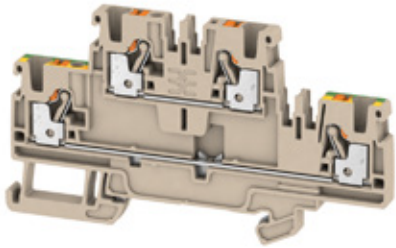

5.1 x 90 x 50.5  
**24 / 2.5**  
**0.14...2.5**

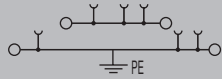

IEC 60947-7-1

IEC	UL	CSA	EN 60079-7
800	600	600	
24	20	20	
2.5	AWG 28...12	AWG 28...12	
8 kV / 3			
A3 / V-0			

CE

**Rated connection**

0.5...2.5 / 0.5...2.5  
 0.5...2.5 / 0.5...2.5  
 10 / 0.6 x 3.5 mm

Approval in progress

Type	Qty.	Order No.
A2T 2.5 FT-PE	50	<b>1547640000</b>

Type	current	Qty.	Order No.
ZQV 2.5N/2	24 A	60	<b>1527540000</b>
ZQV 2.5N/10	24 A	20	<b>1527690000</b>
AEP 2T 2.5		20	<b>1547690000</b>
AEP 2T 2.5 BL		20	<b>1547700000</b>
AEB 35 SC/1		50	<b>1991920000</b>
ZEW 35/2		20	<b>8630740000</b>
ATPG 1.5-10 L		50	<b>1991890000</b>
ATPG 2.5 MI-R		50	<b>1991960000</b>
ATPG 2.5/3		25	<b>2041190000</b>
ATPG 2.5/5		25	<b>2041180000</b>
PS 2.0 MC		20	<b>0310000000</b>
SDIL 0,6x3,5x100		1	<b>9042110000</b>
DEK 5/5 PLUS MC NE WS		1000	<b>1854490000</b>
DEK 5/5 MM WS		800	<b>2007110000</b>
WS 8/5 MM WS		800	<b>2007150000</b>
WS 10/5 M PLUS MC NE WS		600	<b>2003770000</b>
SNAPMARK I		50	<b>1805880000</b>

All MultiMark variants (MM) = strip markers

**A3T 2.5**

**2.5 mm<sup>2</sup>**

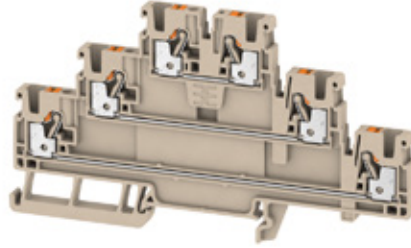

5.1 x 116 x 64.5  
**22 / 2.5**  
**0.14...2.5**

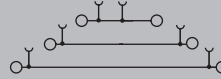

DIN EN 60947-7-1

IEC	UL	CSA	EN 60079-7
800			
22			
2.5			
8 kV / 3			
A3 / V-0			

**Rated connection**

0.5...2.5 / 0.5...2.5  
 0.5...2.5 / 0.5...2.5  
 10 / 0.6 x 3.5 mm

Approval in progress

Type	Qty.	Order No.
A3T 2.5	50	<b>2428510000</b>
A3T 2.5 BL	50	<b>2428520000</b>

Type	current	Qty.	Order No.
ZQV 2.5N/2	24 A	60	<b>1527540000</b>
ZQV 2.5N/10	24 A	20	<b>1527690000</b>
AEP 3T 2.5		20	<b>2428560000</b>
AEP 3T 2.5 BL		20	<b>2428860000</b>
AEB 35 SC/1		50	<b>1991920000</b>
ZEW 35/2		20	<b>8630740000</b>
ATPG 1.5-10 L		50	<b>1991890000</b>
ATPG 2.5 MI-R		50	<b>1991960000</b>
ATPG 2.5/3		25	<b>2041190000</b>
ATPG 2.5/5		25	<b>2041180000</b>
PS 2.0 MC		20	<b>0310000000</b>
SDIL 0,6x3,5x100		1	<b>9042110000</b>
DEK 5/5 PLUS MC NE WS		1000	<b>1854490000</b>
DEK 5/5 MM WS		800	<b>2007110000</b>
WS 8/5 MM WS		800	<b>2007150000</b>
WS 10/5 M PLUS MC NE WS		600	<b>2003770000</b>
SNAPMARK I		50	<b>1805880000</b>

All MultiMark variants (MM) = strip markers

**A3T 2.5 VL**

**2.5 mm<sup>2</sup>**

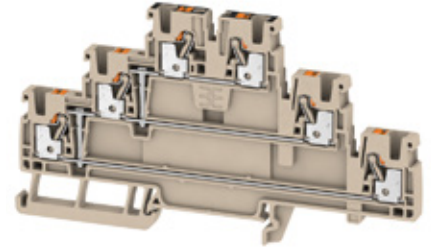

5.1 x 116 x 64.5  
**24 / 2.5**  
**0.14...2.5**

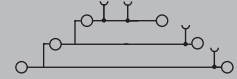

DIN EN 60947-7-1

IEC	UL	CSA	EN 60079-7
800			
24			
2.5			
8 kV / 3			
A3 / V-0			

**Rated connection**

0.5...2.5 / 0.5...2.5  
 0.5...2.5 / 0.5...2.5  
 10 / 0.6 x 3.5 mm

Approval in progress

Type	Qty.	Order No.
A3T 2.5 VL	25	<b>2428540000</b>
A3T 2.5 VL BL	25	<b>2428850000</b>

Type	current	Qty.	Order No.
ZQV 2.5N/2	24 A	60	<b>1527540000</b>
ZQV 2.5N/10	24 A	20	<b>1527690000</b>
AEP 3T 2.5		20	<b>2428560000</b>
AEP 3T 2.5 BL		20	<b>2428860000</b>
AEB 35 SC/1		50	<b>1991920000</b>
ZEW 35/2		20	<b>8630740000</b>
ATPG 1.5-10 L		50	<b>1991890000</b>
ATPG 2.5 MI-R		50	<b>1991960000</b>
ATPG 2.5/3		25	<b>2041190000</b>
ATPG 2.5/5		25	<b>2041180000</b>
PS 2.0 MC		20	<b>0310000000</b>
SDIL 0,6x3,5x100		1	<b>9042110000</b>
DEK 5/5 PLUS MC NE WS		1000	<b>1854490000</b>
DEK 5/5 MM WS		800	<b>2007110000</b>
WS 8/5 MM WS		800	<b>2007150000</b>
WS 10/5 M PLUS MC NE WS		600	<b>2003770000</b>
SNAPMARK I		50	<b>1805880000</b>

All MultiMark variants (MM) = strip markers

Technical data

Machinery

Process

Energy

Transportation

Device Manufacturers

Infrastructure

**A3T 2.5 FT-FT-PE**

2.5 mm<sup>2</sup>

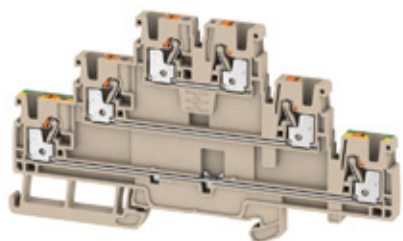

**A3T 2.5 N-FT-PE**

2.5 mm<sup>2</sup>

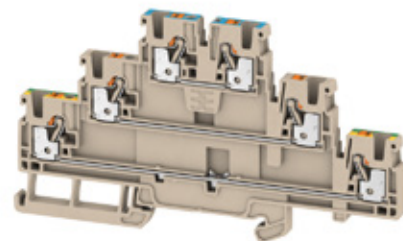

Width/Height/Depth	mm
max. current / max. cond. cross-section	A/mm <sup>2</sup>
Max. clamping range	mm <sup>2</sup>

5.1 x 116 x 64.5
<b>24 / 2.5</b>
<b>0.14...2.5</b>

5.1 x 116 x 64.5
<b>24 / 2.5</b>
<b>0.14...2.5</b>

**Technical data**

<b>Rated data</b>	
Rated voltage	V
Rated current	A
for wire cross-section	mm <sup>2</sup>
Rated impulse withstand voltage / Pollution severity	
Gauge to IEC 60947-1 / UL 94 flammability rating	
Approvals	
<b>Clamped conductors (H05V/H07V)</b>	
Solid / Stranded	mm <sup>2</sup>
Flexible / Flexible with ferrule	mm <sup>2</sup>
Stripping length / Blade size	mm/-
<b>Note</b>	

DIN EN 60947-7-1, DIN EN 60947-7-2

<b>IEC</b>	<b>UL</b>	<b>CSA</b>	<b>EN 60079-7</b>
800			
24			
2.5			
	8 kV / 3		
	A3 / V-0		
<b>Rated connection</b>			
0.5...2.5 / 0.5...2.5			
0.5...2.5 / 0.5...2.5			
10 / 0.6 x 3.5 mm			
Approval in progress			

DIN EN 60947-7-1, DIN EN 60947-7-2

<b>IEC</b>	<b>UL</b>	<b>CSA</b>	<b>EN 60079-7</b>
800			
24			
2.5			
	8 kV / 3		
	A3 / V-0		
<b>Rated connection</b>			
0.5...2.5 / 0.5...2.5			
0.5...2.5 / 0.5...2.5			
10 / 0.6 x 3.5 mm			
Approval in progress			

**Ordering data**

<b>Version</b>	dark beige blue
<b>Note</b>	

<b>Type</b>	<b>Qty.</b>	<b>Order No.</b>
A3T 2.5 FT-FT-PE	50	2428530000

<b>Type</b>	<b>Qty.</b>	<b>Order No.</b>
A3T 2.5 N-FT-PE	50	2428840000

**Accessories**

<b>Pluggable cross-connection</b>	
	2-pole
	10-pole
<b>End plate</b>	
	dark beige
	blue
<b>End bracket</b>	
	dark beige
	dark beige
<b>Test adapter</b>	
	1-pole
	stackable
	3-pole
	5-pole
<b>Test plug</b>	
<b>Screwdriver</b>	
	Standard
<b>Identification systems</b>	

<b>Type</b>	<b>current</b>	<b>Qty.</b>	<b>Order No.</b>
ZQV 2.5N/2	24 A	60	1527540000
ZQV 2.5N/10	24 A	20	1527690000
<b>End plate</b>			
AEP 3T 2.5		20	2428560000
AEP 3T 2.5 BL		20	2428860000
<b>End bracket</b>			
AEB 35 SC/1		50	1991920000
ZEW 35/2		20	8630740000
<b>Test adapter</b>			
ATPG 1.5-10 L		50	1991890000
ATPG 2.5 MHR		50	1991960000
ATPG 2.5/3		25	2041190000
ATPG 2.5/5		25	2041180000
<b>Test plug</b>			
PS 2.0 MC		20	0310000000
<b>Screwdriver</b>			
SDIL 0,6x3,5x100		1	9042110000
<b>Identification systems</b>			
DEK 5/5 PLUS MC NE WS		1000	1854490000
DEK 5/5 MM WS		800	2007110000
WS 8/5 MM WS		800	2007150000
WS 10/5 M PLUS MC NE WS		600	2003770000
SNAPMARK I		50	1805880000

<b>Type</b>	<b>current</b>	<b>Qty.</b>	<b>Order No.</b>
ZQV 2.5N/2	24 A	60	1527540000
ZQV 2.5N/10	24 A	20	1527690000
<b>End plate</b>			
AEP 3T 2.5		20	2428560000
AEP 3T 2.5 BL		20	2428860000
<b>End bracket</b>			
AEB 35 SC/1		50	1991920000
ZEW 35/2		20	8630740000
<b>Test adapter</b>			
ATPG 1.5-10 L		50	1991890000
ATPG 2.5 MHR		50	1991960000
ATPG 2.5/3		25	2041190000
ATPG 2.5/5		25	2041180000
<b>Test plug</b>			
PS 2.0 MC		20	0310000000
<b>Screwdriver</b>			
SDIL 0,6x3,5x100		1	9042110000
<b>Identification systems</b>			
DEK 5/5 PLUS MC NE WS		1000	1854490000
DEK 5/5 MM WS		800	2007110000
WS 8/5 MM WS		800	2007150000
WS 10/5 M PLUS MC NE WS		600	2003770000
SNAPMARK I		50	1805880000

For detailed information on other accessories and application in the online catalogue

All MultiMark variants (MM) = strip markers

All MultiMark variants (MM) = strip markers

**AMC 2.5**

**2.5 mm<sup>2</sup>**



5.1 x 107 x 88.5  
**21 / 2.5**  
**0.14...2.5**

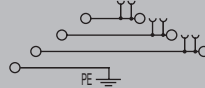

DIN EN 60947-7-1, DIN EN 60947-7-2

IEC	UL	CSA	EN 60079-7
690			
21			
2.5			
		8 kV / 3	
		A3 / V-0	
Rated connection			
0.5...2.5 / 0.5...2.5			
0.5...2.5 / 0.5...2.5			
10 / 0.6 x 3.5 mm			
Approval in progress			

**AMC 2.5 800 V**

**2.5 mm<sup>2</sup>**



6.1 x 107 x 88.5  
**21 / 2.5**  
**0.14...2.5**

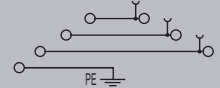

DIN EN 60947-7-1, DIN EN 60947-7-2

IEC	UL	CSA	EN 60079-7
800			
21			
2.5			
		8 kV / 3	
		A3 / V-0	
Rated connection			
0.5...2.5 / 0.5...2.5			
0.5...2.5 / 0.5...2.5			
10 / 0.6 x 3.5 mm			
Approval in progress			

Width/Height/Depth mm  
 max. current / max. cond. cross-section A/mm<sup>2</sup>  
 Max. clamping range mm<sup>2</sup>

**Technical data**

Rated data	
Rated voltage	V
Rated current	A
for wire cross-section	mm <sup>2</sup>
Rated impulse withstand voltage / Pollution severity	
Gauge to IEC 60947-1 / UL 94 flammability rating	
Approvals	
Clamped conductors (H05V/H07V)	
Solid / Stranded	mm <sup>2</sup>
Flexible / Flexible with ferrule	mm <sup>2</sup>
Stripping length / Blade size	mm/-
Note	

**Ordering data**

Version	
	dark beige
Note	

**Accessories**

Pluggable cross-connection	
	2-pole
	10-pole
Vertical jumpers	
	1-pole
End plate	
	dark beige
End bracket	
	dark beige
	dark beige
Test plug	
Screwdriver	
	Standard
Identification systems	

Type	Qty.	Order No.
AMC 2.5	50	2434340000

Type	Qty.	Order No.
AMC 2.5 800V	50	2434370000

Type	current	Qty.	Order No.
ZQV 2.5N/2	24 A	60	1527540000
ZQV 2.5N/10	24 A	20	1527690000
ZVQ 2.5/1.5	23 A	50	1720700000
AEP MC 2.5		25	2433820000
AEB 35 SC/1	50		1991920000
ZEW 35/2	20		8630740000
PS 2.0 MC		20	0310000000
SDIL 0,6x3,5x100		1	9042110000
DEK 5/5 PLUS MC NE WS	1000		1854490000
DEK 5/5 MM WS	800		2007110000
WS 8/5 MM WS	800		2007150000
WS 10/5 M PLUS MC NE WS	600		2003770000
SNAPMARK I	50		1805880000

Type	current	Qty.	Order No.
ZVQ 2.5/1.5	23 A	50	1720700000
AEB 35 SC/1	50		1991920000
ZEW 35/2	20		8630740000
PS 2.0 MC		20	0310000000
SDIL 0,6x3,5x100		1	9042110000
DEK 5/5 PLUS MC NE WS	1000		1854490000
DEK 5/5 MM WS	800		2007110000
WS 8/5 MM WS	800		2007150000
WS 10/5 M PLUS MC NE WS	600		2003770000
SNAPMARK I	50		1805880000

For detailed information on other accessories and application in the online catalogue

All MultiMark variants (MM) = strip markers

All MultiMark variants (MM) = strip markers

Technical data

Machinery

Process

Energy

Transportation

Device Manufacturers

Infrastructure

**A2C 1.5 PE**

1.5 mm<sup>2</sup>

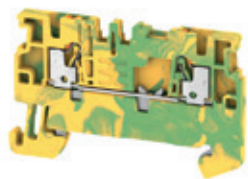

**A3C 1.5 PE**

1.5 mm<sup>2</sup>

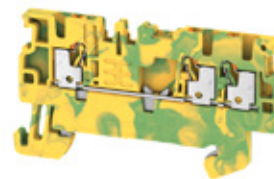

Width/Height/Depth	mm
max. current / max. cond. cross-section	-/mm <sup>2</sup>
Max. clamping range	mm <sup>2</sup>

3.5 x 55 x 33.5	
/ 1.5	
0.14...1.5	

3.5 x 61.5 x 33.5	
/ 1.5	
0.14...1.5	

**Technical data**

<b>Rated data</b>	
for wire cross-section	mm <sup>2</sup>
Rated voltage to adjoining terminal	V
Rated impulse withstand voltage to adjacent terminal	kV
Rated short-time current	
Pollution severity	
Gauge to IEC 60947-1 / UL 94 flammability rating	
Approvals	
<b>Clamped conductors (H05V/H07V)</b>	
Solid / Stranded	mm <sup>2</sup>
Flexible / Flexible with ferrule	mm <sup>2</sup>
Stripping length / Blade size	mm/-
<b>Note</b>	

IEC 60947-7-2			
<b>IEC</b>	<b>UL</b>	<b>CSA</b>	<b>EN 60079-7</b>
1.5	AWG 26...14		
500			
6			
180 A (1.5 mm <sup>2</sup> )			
3			
A1 / V-0			
<b>Rated connection</b>			
0.5...1.5 / 0.5...1.5			
0.5...1.5 / 0.5...1.5			
8 / 0.4 x 2.0 mm			
Approval in progress			

IEC 60947-7-2			
<b>IEC</b>	<b>UL</b>	<b>CSA</b>	<b>EN 60079-7</b>
1.5	AWG 26...14		
500			
6			
180 A (1.5 mm <sup>2</sup> )			
3			
A1 / V-0			
<b>Rated connection</b>			
0.5...1.5 / 0.5...1.5			
0.5...1.5 / 0.5...1.5			
8 / 0.4 x 2.0 mm			
Approval in progress			

**Ordering data**

<b>Version</b>	green/yellow
<b>Note</b>	

<b>Type</b>	<b>Qty.</b>	<b>Order No.</b>
A2C 1.5 PE	50	1552680000

<b>Type</b>	<b>Qty.</b>	<b>Order No.</b>
A3C 1.5 PE	50	1552670000

**Accessories**

<b>End plate</b>	dark beige
<b>End bracket</b>	dark beige
<b>Test adapter</b>	1-pole stackable
	3-pole
	5-pole
<b>Test plug</b>	
<b>Screwdriver</b>	Standard
<b>Identification systems</b>	

<b>Type</b>	<b>current</b>	<b>Qty.</b>	<b>Order No.</b>
AEP 2C 1.5		50	1552600000
AEB 35 SC/1		50	1991920000
ZEW 35		20	9540000000
ATPG 1.5-10 L		50	1991890000
ATPG 1.5 MI-R		50	1991880000
PS 2.0 MC		20	0310000000
SDS 0.4X2.0X60		1	9037160000
WS 10/3.5 PLUS MC NE WS		960	2003760000
DEK 5/3.5 MM WS		1000	2007100000
WS 8/3.5 MM WS		1000	2007140000
DEK 5/3.5 PLUS MC NE WS		1600	2003750000

<b>Type</b>	<b>current</b>	<b>Qty.</b>	<b>Order No.</b>
AEP 3C 1.5		50	1552620000
AEB 35 SC/1		50	1991920000
ZEW 35		20	9540000000
ATPG 1.5-10 L		50	1991890000
ATPG 1.5 MI-R		50	1991880000
PS 2.0 MC		20	0310000000
SDS 0.4X2.0X60		1	9037160000
WS 10/3.5 PLUS MC NE WS		960	2003760000
DEK 5/3.5 MM WS		1000	2007100000
WS 8/3.5 MM WS		1000	2007140000
DEK 5/3.5 PLUS MC NE WS		1600	2003750000

For detailed information on other accessories and application in the online catalogue

All MultiMark variants (MM) = strip markers

All MultiMark variants (MM) = strip markers

**A4C 1.5 PE**

**1.5 mm<sup>2</sup>**

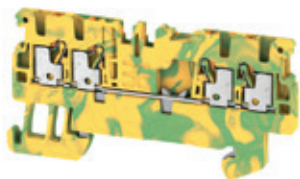

3.5 x 67.5 x 33.5  
/ 1.5  
0.14...1.5

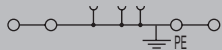

IEC 60947-7-2

IEC	UL	CSA	EN 60079-7
1.5	AWG 26...14		
500			
6			
	180 A (1.5 mm <sup>2</sup> )		
	3		
	A1 / V-0		

CE

**Rated connection**

0.5...1.5 / 0.5...1.5  
0.5...1.5 / 0.5...1.5  
8 / 0.4 x 2.0 mm

Approval in progress

Type	Qty.	Order No.
A4C 1.5 PE	50	1552660000

Type	current	Qty.	Order No.
AEP 4C 1.5		50	1552640000
AEB 35 SC/1		50	1991920000
ZEW 35		20	9540000000
ATPG 1.5-10 L		50	1991890000
ATPG 1.5 MI-R		50	1991880000
PS 2.0 MC		20	0310000000
SDS 0.4X2.0X60		1	9037160000
WS 10/3.5 PLUS MC NE WS		960	2003760000
DEK 5/3.5 MM WS		1000	2007100000
WS 8/3.5 MM WS		1000	2007140000
DEK 5/3.5 PLUS MC NE WS		1600	2003750000

All MultiMark variants (MM) = strip markers

**A2C 2.5 PE**

**2.5 mm<sup>2</sup>**

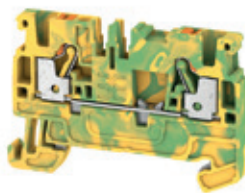

5.1 x 55 x 36.5  
/ 2.5  
0.14...2.5



IEC 60947-7-2

IEC	UL	CSA	EN 60079-7
2.5	AWG 28...12	AWG 28...12	
800			
8			
	300 A (2.5 mm <sup>2</sup> )		
	3		
	A3 / V-0		

CE

**Rated connection**

0.5...2.5 / 0.5...2.5  
0.5...2.5 / 0.5...2.5  
10 / 0.6 x 3.5 mm

Approval in progress

Type	Qty.	Order No.
A2C 2.5 PE	50	1521680000

Type	current	Qty.	Order No.
AEP 2C 2.5		50	1514400000
AEB 35 SC/1		50	1991920000
ZEW 35		20	9540000000
ATPG 1.5-10 L		50	1991890000
ATPG 2.5 MI-R		50	1991960000
ATPG 2.5/3		25	2041190000
ATPG 2.5/5		25	2041180000
PS 2.0 MC		20	0310000000
SDIL 0,6x3,5x100		1	9042110000
DEK 5/5 PLUS MC NE WS		1000	1854490000
DEK 5/5 MM WS		800	2007110000
WS 8/5 MM WS		800	2007150000
WS 10/5 M PLUS MC NE WS		600	2003770000

All MultiMark variants (MM) = strip markers

**A3C 2.5 PE**

**2.5 mm<sup>2</sup>**

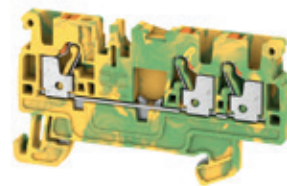

5.1 x 66.5 x 36.5  
/ 2.5  
0.14...2.5

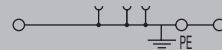

IEC 60947-7-2

IEC	UL	CSA	EN 60079-7
2.5	AWG 28...12	AWG 28...12	
800			
8			
	300 A (2.5 mm <sup>2</sup> )		
	3		
	A3 / V-0		

CE

**Rated connection**

0.5...2.5 / 0.5...2.5  
0.5...2.5 / 0.5...2.5  
10 / 0.6 x 3.5 mm

Approval in progress

Type	Qty.	Order No.
A3C 2.5 PE	50	1521670000

Type	current	Qty.	Order No.
AEP 3C 2.5		50	1521510000
AEB 35 SC/1		50	1991920000
ZEW 35		20	9540000000
ATPG 1.5-10 L		50	1991890000
ATPG 2.5 MI-R		50	1991960000
ATPG 2.5/3		25	2041190000
ATPG 2.5/5		25	2041180000
PS 2.0 MC		20	0310000000
SDIL 0,6x3,5x100		1	9042110000
DEK 5/5 PLUS MC NE WS		1000	1854490000
DEK 5/5 MM WS		800	2007110000
WS 8/5 MM WS		800	2007150000
WS 10/5 M PLUS MC NE WS		600	2003770000

All MultiMark variants (MM) = strip markers

Technical data

Machinery

Process

Energy

Transportation

Device Manufacturers

Infrastructure

**A4C 2.5 PE**

**2.5 mm<sup>2</sup>**

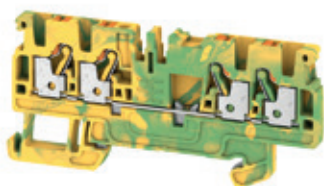

Width/Height/Depth	mm
max. current / max. cond. cross-section	-/mm <sup>2</sup>
Max. clamping range	mm <sup>2</sup>

5.1 x 77.5 x 36.5
<b>/ 2.5</b>
<b>0.14...2.5</b>

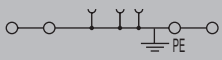

**Technical data**

<b>Rated data</b>	
for wire cross-section	mm <sup>2</sup>
Rated voltage to adjoining terminal	V
Rated impulse withstand voltage to adjacent terminal	kV
Rated short-time current	
Pollution severity	
Gauge to IEC 60947-1 / UL 94 flammability rating	
Approvals	

<b>Clamped conductors (H05V/H07V)</b>	
Solid / Stranded	mm <sup>2</sup>
Flexible / Flexible with ferrule	mm <sup>2</sup>
Stripping length / Blade size	mm/-

**Note**

IEC 60947-7-2

IEC	UL	CSA	EN 60079-7
2.5	AWG 28...12	AWG 28...12	
800			
8			
300 A (2.5 mm <sup>2</sup> )			
3			
A3 / V-0			

<b>Rated connection</b>	
0.5...2.5 / 0.5...2.5	
0.5...2.5 / 0.5...2.5	
10 / 0.6 x 3.5 mm	

Approval in progress

**Ordering data**

<b>Version</b>	green/yellow
<b>Note</b>	

Type	Qty.	Order No.
A4C 2.5 PE	50	<b>1521540000</b>

**Accessories**

<b>End plate</b>	dark beige
<b>End bracket</b>	dark beige
<b>Test adapter</b>	1-pole stackable 3-pole 5-pole
<b>Test plug</b>	
<b>Screwdriver</b>	Standard
<b>Identification systems</b>	

Type	current	Qty.	Order No.
AEP 4C 2.5		50	<b>1521530000</b>
AEB 35 SC/1		50	<b>1991920000</b>
ZEW 35		20	<b>9540000000</b>
ATPG 1.5-10 L		50	<b>1991890000</b>
ATPG 2.5 MHR		50	<b>1991960000</b>
ATPG 2.5/3		25	<b>2041190000</b>
ATPG 2.5/5		25	<b>2041180000</b>
PS 2.0 MC		20	<b>0310000000</b>
SDIL 0,6x3,5x100		1	<b>9042110000</b>
DEK 5/5 PLUS MC NE WS		1000	<b>1854490000</b>
DEK 5/5 MM WS		800	<b>2007110000</b>
WS 8/5 MM WS		800	<b>2007150000</b>
WS 10/5 M PLUS MC NE WS		600	<b>2003770000</b>

For detailed information on other accessories and application in the online catalogue

All MultiMark variants (MM) = strip markers

**A2C 4 PE**

**4 mm<sup>2</sup>**

**A3C 4 PE**

**4 mm<sup>2</sup>**

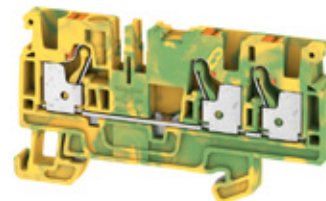

Width/Height/Depth	mm
max. current / max. cond. cross-section	-/mm <sup>2</sup>
Max. clamping range	mm <sup>2</sup>

6.1 x 60 x 39.5	
/ 4	
0.5...4	

6.1 x 74 x 39.5	
/ 4	
0.5...4	

**Technical data**

<b>Rated data</b>	
for wire cross-section	mm <sup>2</sup>
Rated voltage to adjoining terminal	V
Rated impulse withstand voltage to adjacent terminal	kV
Rated short-time current	
Pollution severity	
Gauge to IEC 60947-1 / UL 94 flammability rating	
Approvals	
<b>Clamped conductors (H05V/H07V)</b>	
Solid / Stranded	mm <sup>2</sup>
Flexible / Flexible with ferrule	mm <sup>2</sup>
Stripping length / Blade size	mm/-
<b>Note</b>	

IEC 60947-7-2

IEC	UL	CSA	EN 60079-7
4	AWG 28...10	AWG 26...10	
800			
8			
	480 A (4 mm <sup>2</sup> )		
	3		
	A4 / V-0		

CE

<b>Rated connection</b>	
Solid / Stranded	mm <sup>2</sup>
Flexible / Flexible with ferrule	mm <sup>2</sup>
Stripping length / Blade size	mm/-

12 / 0.6 x 3.5 mm

Approval in progress

IEC 60947-7-2

IEC	UL	CSA	EN 60079-7
4	AWG 28...10	AWG 26...10	
800			
8			
	480 A (4 mm <sup>2</sup> )		
	3		
	A4 / V-0		

CE

<b>Rated connection</b>	
Solid / Stranded	mm <sup>2</sup>
Flexible / Flexible with ferrule	mm <sup>2</sup>
Stripping length / Blade size	mm/-

12 / 0.6 x 3.5 mm

Approval in progress

**Ordering data**

Version	green/yellow
<b>Note</b>	

Type	Qty.	Order No.
A2C 4 PE	50	2051360000

Type	Qty.	Order No.
A3C 4 PE	50	2051410000

**Accessories**

<b>End plate</b>	dark beige
<b>End bracket</b>	dark beige
<b>Test adapter</b>	1-pole stackable
<b>Test plug</b>	
<b>Screwdriver</b>	Standard
<b>Identification systems</b>	

Type	current	Qty.	Order No.
AEP 2C 4		50	2051680000
AEB 35 SC/1		50	1991920000
ZEW 35		20	9540000000
ATPG 1.5-10 L		50	1991890000
ATPG 4 MHR		50	1991860000
PS 2.0 MC		20	0310000000
SDIL 0,6x3,5x100		1	9042110000
DEK 5/6 PLUS MC NE WS		1000	1011320000
WS 10/6 M PLUS MC NE WS		600	2003780000
DEK 5/6 MM WS		600	2007120000
WS 8/6 MM WS		600	2007160000

Type	current	Qty.	Order No.
AEP 3C 4		20	2051720000
AEB 35 SC/1		50	1991920000
ZEW 35		20	9540000000
ATPG 1.5-10 L		50	1991890000
ATPG 4 MHR		50	1991860000
PS 2.0 MC		20	0310000000
SDIL 0,6x3,5x100		1	9042110000
DEK 5/6 PLUS MC NE WS		1000	1011320000
WS 10/6 M PLUS MC NE WS		600	2003780000
DEK 5/6 MM WS		600	2007120000
WS 8/6 MM WS		600	2007160000

For detailed information on other accessories and application in the online catalogue

All MultiMark variants (MM) = strip markers

All MultiMark variants (MM) = strip markers

Technical data  
Machinery  
Process  
Energy  
Transportation  
Device Manufacturers  
Infrastructure

Technical data

Machinery

Process

Energy

Transportation

Device Manufacturers

Infrastructure

**A4C 4 PE**

**4 mm<sup>2</sup>**

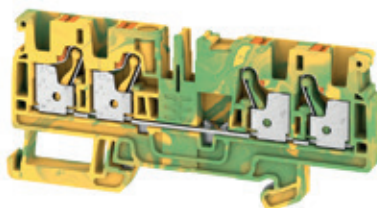

**A2C 6 PE**

**6 mm<sup>2</sup>**

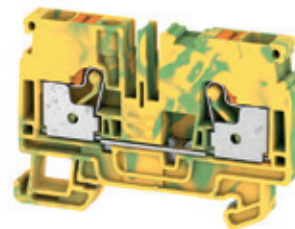

Width/Height/Depth	mm
max. current / max. cond. cross-section	-/mm <sup>2</sup>
Max. clamping range	mm <sup>2</sup>

6.1 x 87.5 x 39.5	
/ 4	
<b>0.5...4</b>	

8.1 x 66.5 x 45.5	
/ 6	
<b>0.5...6</b>	

**Technical data**

<b>Rated data</b>	
for wire cross-section	mm <sup>2</sup>
Rated voltage to adjoining terminal	V
Rated impulse withstand voltage to adjacent terminal	kV
Rated short-time current	
Pollution severity	
Gauge to IEC 60947-1 / UL 94 flammability rating	
Approvals	
<b>Clamped conductors (H05V/H07V)</b>	
Solid / Stranded	mm <sup>2</sup>
Flexible / Flexible with ferrule	mm <sup>2</sup>
Stripping length / Blade size	mm/-
<b>Note</b>	

IEC 60947-7-2			
<b>IEC</b>	<b>UL</b>	<b>CSA</b>	<b>EN 60079-7</b>
4	AWG 28...10	AWG 26...10	
800			
8			
	480 A (4 mm <sup>2</sup> )		
	3		
	A4 / V-0		
<b>Rated connection</b>			
0.5...4 / 0.5...4			
0.5...4 / 0.5...4			
12 / 0.6 x 3.5 mm			
Approval in progress			

IEC 60947-7-2			
<b>IEC</b>	<b>UL</b>	<b>CSA</b>	<b>EN 60079-7</b>
6	AWG 22...8	AWG 22...8	
800			
8			
	720 A (6 mm <sup>2</sup> )		
	3		
	A5 / V-0		
<b>Rated connection</b>			
0.5...6 / 0.5...6			
0.5...6 / 0.5...6			
12 / 1.0 x 5.5 mm			
Approval in progress			

**Ordering data**

<b>Version</b>	green/yellow
<b>Note</b>	

<b>Type</b>	<b>Qty.</b>	<b>Order No.</b>
A4C 4 PE	50	<b>2051560000</b>

<b>Type</b>	<b>Qty.</b>	<b>Order No.</b>
A2C 6 PE	50	<b>1991810000</b>

**Accessories**

<b>End plate</b>	dark beige
<b>End bracket</b>	dark beige
<b>Test adapter</b>	1-pole stackable
<b>Test plug</b>	
<b>Screwdriver</b>	Standard
<b>Identification systems</b>	

<b>Type</b>	<b>current</b>	<b>Qty.</b>	<b>Order No.</b>
AEP 4C 4		20	<b>2051900000</b>
AEB 35 SC/1		50	<b>1991920000</b>
ZEW 35		20	<b>9540000000</b>
ATPG 1.5-10 L		50	<b>1991890000</b>
ATPG 4 MHR		50	<b>1991860000</b>
PS 2.0 MC		20	<b>0310000000</b>
SDIL 0,6x3,5x100		1	<b>9042110000</b>
DEK 5/6 PLUS MC NE WS		1000	<b>1011320000</b>
WS 10/6 M PLUS MC NE WS		600	<b>2003780000</b>
DEK 5/6 MM WS		600	<b>2007120000</b>
WS 8/6 MM WS		600	<b>2007160000</b>

<b>Type</b>	<b>current</b>	<b>Qty.</b>	<b>Order No.</b>
AEP 2C 6		50	<b>1991970000</b>
AEB 35 SC/1		50	<b>1991920000</b>
ZEW 35		20	<b>9540000000</b>
ATPG 1.5-10 L		50	<b>1991890000</b>
ATPG 6 MHR		50	<b>1991930000</b>
PS 2.0 MC		20	<b>0310000000</b>
SDIL 1,0x5,5x125		1	<b>9042130000</b>
WS-A 8/8 MM WS		500	<b>2448930000</b>
DEK-A 5/8 MM WS		500	<b>2448860000</b>
DEK 5/8 PLUS MC NE WS		800	<b>1046350000</b>
WS 10/8 PLUS MC NE WS		420	<b>1905950000</b>

For detailed information on other accessories and application in the online catalogue

All MultiMark variants (MM) = strip markers

All MultiMark variants (MM) = strip markers



**A3C 6 PE**

**6 mm<sup>2</sup>**

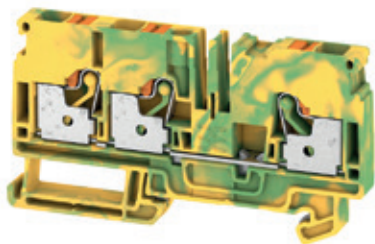

8.1 x 84.5 x 45.5  
/ 6  
0.5...6

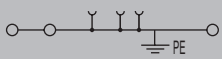

IEC 60947-7-2

IEC	UL	CSA	EN 60079-7
6	AWG 22...8	AWG 22...8	
800			
8			
	720 A (6 mm <sup>2</sup> )		
	3		
	A5 / V-0		

CE

**Rated connection**

0.5...6 / 0.5...6  
0.5...6 / 0.5...6  
12 / 1.0 x 5.5 mm

Approval in progress

Type	Qty.	Order No.
A3C 6 PE	50	1991850000

Type	current	Qty.	Order No.
AEP 3C 6		50	1991940000
AEB 35 SC/1		50	1991920000
ZEW 35		20	9540000000
ATPG 1.5-10 L		50	1991890000
ATPG 6 MI-R		50	1991930000
PS 2.0 MC		20	0310000000
SDIL 1,0x5,5x125		1	9042130000
WS-A 8/8 MM WS		500	2448930000
DEK-A 5/8 MM WS		500	2448860000
DEK 5/8 PLUS MC NE WS		800	1046350000
WS 10/8 PLUS MC NE WS		420	1905950000

All MultiMark variants (MM) = strip markers

**A2T 2.5 PE**

**2.5 mm<sup>2</sup>**

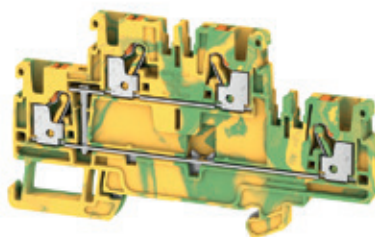

5.1 x 90 x 50.5  
/ 2.5  
0.14...2.5

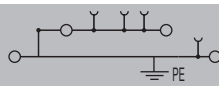

IEC 60947-7-2

IEC	UL	CSA	EN 60079-7
2.5	AWG 28...12	AWG 28...12	
800			
8			
	300 A (2.5 mm <sup>2</sup> )		
	3		
	A3 / V-0		

CE

**Rated connection**

0.5...2.5 / 0.5...2.5  
0.5...2.5 / 0.5...2.5  
10 / 0.6 x 3.5 mm

Approval in progress

Type	Qty.	Order No.
A2T 2.5 PE	50	1547680000

Type	current	Qty.	Order No.
AEP 2T 2.5		20	1547690000
AEB 35 SC/1		50	1991920000
ZEW 35/2		20	8630740000
ATPG 1.5-10 L		50	1991890000
ATPG 2.5 MI-R		50	1991960000
PS 2.0 MC		20	0310000000
SDIL 0,6x3,5x100		1	9042110000
WS 10/5 M PLUS MC NE WS		600	2003770000
DEK 5/5 PLUS MC NE WS		1000	1854490000
DEK 5/5 MM WS		800	2007110000
WS 8/5 MM WS		800	2007150000

All MultiMark variants (MM) = strip markers

**A3T 2.5 PE**

**2.5 mm<sup>2</sup>**

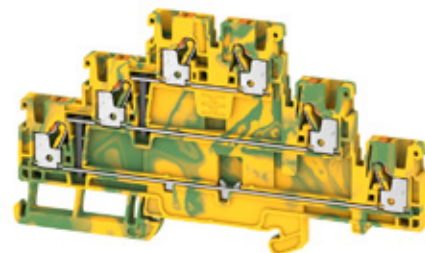

5.1 x 116 x 64.5  
/ 2.5  
0.14...2.5

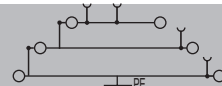

DIN EN 60947-7-2

IEC	UL	CSA	EN 60079-7
2.5			
800			
8			
	300 A (2.5 mm <sup>2</sup> )		
	3		
	A3 / V-0		

**Rated connection**

0.5...2.5 / 0.5...2.5  
0.5...2.5 / 0.5...2.5  
10 / 0.6 x 3.5 mm

Approval in progress

Type	Qty.	Order No.
A3T 2.5 PE	50	2428550000

Type	current	Qty.	Order No.
AEP 3T 2.5		20	2428560000
AEB 35 SC/1		50	1991920000
ZEW 35/2		20	8630740000
ATPG 1.5-10 L		50	1991890000
ATPG 2.5 MI-R		50	1991960000
PS 2.0 MC		20	0310000000
SDIL 0,6x3,5x100		1	9042110000
WS 10/5 M PLUS MC NE WS		600	2003770000
DEK 5/5 PLUS MC NE WS		1000	1854490000
DEK 5/5 MM WS		800	2007110000
WS 8/5 MM WS		800	2007150000

All MultiMark variants (MM) = strip markers

Technical data

Machinery



Process



Energy



Transportation



Device Manufacturers



Infrastructure



Technical data

Machinery

Process

Energy

Transportation

Device Manufacturers

Infrastructure

**AFS 2.5 CF 2C**

**2.5 mm<sup>2</sup>**

**AFS 4 2C**

**4 mm<sup>2</sup>**

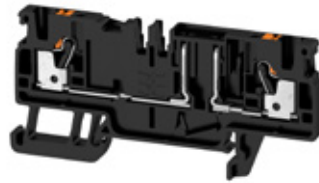

Width/Height/Depth	mm
max. current / max. cond. cross-section	A/mm <sup>2</sup>
Max. clamping range	mm <sup>2</sup>

5.1 x 77.5 x 36.5
<b>10 / 2.5</b>
<b>2.5...2.5</b>

6.1 x 80 x 69
<b>6.3 / 4</b>
<b>0.5...4</b>



**Technical data**

Rated data	
Rated voltage to adjoining terminal	V
Rated current	A
for wire cross-section	mm <sup>2</sup>
Rated impulse withstand voltage / Pollution severity	
Gauge to IEC 60947-1 / UL 94 flammability rating	
Approvals	
Clamped conductors (H05V/H07V)	
Solid / Stranded	mm <sup>2</sup>
Flexible / Flexible with ferrule	mm <sup>2</sup>
Stripping length / Blade size	
Note	

In accordance with IEC 60947-7-3

IEC	UL	CSA	EN 60079-7
400			
10			
2.5			
	/ 3		
	A3 /		
Rated connection			
0.5...2.5 / 0.5...2.5			
0.5...2.5 / 0.5...2.5			
10 / 0.6 x 3.5 mm			
Note			

DIN EN 60947-7-3

IEC	UL	CSA	EN 60079-7
250			
6.3			
4			
	/ 3		
	A4 / V-0		
Rated connection			
0.5...4 / 0.5...4			
0.5...4 / 0.5...4			
12 / 0.6 x 3.5 mm			
Note			

**Ordering data**

Version	
	500 V AC/DC, without LED
	10-36 V AC/DC, with LED
	30-70 V AC/DC, with LED
	60-150 V AC/DC, with LED
	100-250 V AC/DC, with LED
Note	

Type	Qty.	Order No.
AFS 2.5 CF 2C BK	50	<b>2466530000</b>
AFS 2.5 CF 2C 12V BK	50	<b>2466610000</b>
AFS 2.5 CF 2C 24V BK	50	<b>2466600000</b>
Note		

Type	Qty.	Order No.
AFS 4 2C BK	50	<b>2429860000</b>
AFS 4 2C 10-36V BK	50	<b>2429870000</b>
AFS 4 2C 30-70V BK	50	<b>2434350000</b>
AFS 4 2C 60-150V BK	50	<b>2434380000</b>
AFS 4 2C 100-250V BK	50	<b>2434390000</b>
Note		

**Accessories**

Pluggable cross-connection	
	2-pole
	10-pole
	2-pole
	10-pole
End plate	
	Black
Test plug	
	Black
Screwdriver	
	Standard
Identification systems	

Type	current	Qty.	Order No.
ZQV 2.5N/2	24 A	60	<b>1527540000</b>
ZQV 2.5N/10	24 A	20	<b>1527690000</b>
End plate			
AEP 4C 2.5 BK		50	<b>2486660000</b>
Test plug			
PS 2.0 MC		20	<b>0310000000</b>
Screwdriver			
SDIL 0,6x3,5x100		1	<b>9042110000</b>
Identification systems			
DEK 5/5 PLUS MC NE WS		1000	<b>1854490000</b>
WS 10/5 M PLUS MC NE WS		600	<b>2003770000</b>
DEK 5/5 MM WS		800	<b>2007110000</b>
WS 8/5 MM WS		800	<b>2007150000</b>

Type	current	Qty.	Order No.
ZQV 4N/2	32 A	60	<b>1527930000</b>
ZQV 4N/10	32 A	20	<b>1528090000</b>
End plate			
AEP 3C 4 BK		20	<b>2486640000</b>
Test plug			
PS 2.0 MC		20	<b>0310000000</b>
Screwdriver			
SDIL 0,6x3,5x100		1	<b>9042110000</b>
Identification systems			
WS 10/6 M PLUS MC NE WS		600	<b>2003780000</b>
DEK 5/6 PLUS MC NE WS		1000	<b>1011320000</b>
DEK 5/6 MM WS		600	<b>2007120000</b>
WS 8/6 MM WS		600	<b>2007160000</b>

For detailed information on other accessories and application in the online catalogue

**ADT 2.5 2C**

**2.5 mm<sup>2</sup>**

**ADT 2.5 2C W/O DTLV**

**2.5 mm<sup>2</sup>**

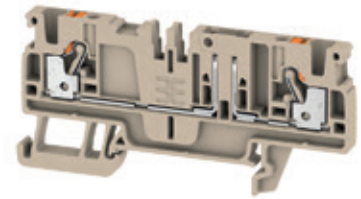
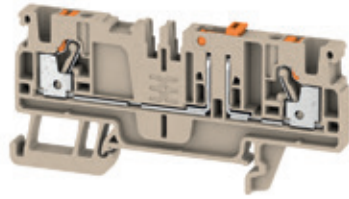

Width/Height/Depth	mm
max. current / max. cond. cross-section	A/mm <sup>2</sup>
Max. clamping range	mm <sup>2</sup>

5.1 x 77.5 x 37.65
<b>20 / 2.5</b>
<b>0.14...2.5</b>

5.1 x 77.5 x 36.5
<b>20 / 2.5</b>
<b>0.14...2.5</b>

**Technical data**

Rated data	
Rated voltage of feed-through terminal	V
Rated current	A
for wire cross-section	mm <sup>2</sup>
Rated impulse withstand voltage / Pollution severity	
Gauge to IEC 60947-1 / UL 94 flammability rating	
Number of operating cycles	
Approvals	
Clamped conductors (H05V/H07V)	
Solid / Stranded	mm <sup>2</sup>
Flexible / Flexible with ferrule	mm <sup>2</sup>
Stripping length / Blade size	mm/-
Note	

IEC 60947-7-1

IEC	UL	CSA	EN 60079-7
400	300	300	
20	20	20	
2.5	AWG 28...12	AWG 28...12	
6 kV / 3			
A3 / V-0			

CE

Rated connection	
0.5...2.5 / 0.5...2.5	
0.5...2.5 / 0.5...2.5	
10 / 0.6 x 3.5 mm	

Approval in progress

IEC 60947-7-1

IEC	UL	CSA	EN 60079-7
400	300	300	
20	20	20	
2.5	AWG 28...12	AWG 28...12	
6 kV / 3			
A3 / V-0			

CE

Rated connection	
0.5...2.5 / 0.5...2.5	
0.5...2.5 / 0.5...2.5	
10 / 0.6 x 3.5 mm	

Approval in progress

**Ordering data**

Version	
	dark beige
	blue
	without isolator
Note	

Type	Qty.	Order No.
ADT 2.5 2C	50	<b>1989800000</b>
ADT 2.5 2C BL	50	<b>1989810000</b>

Type	Qty.	Order No.
ADT 2.5 2C W/O DTLV	50	<b>1989930000</b>

**Accessories**

Pluggable cross-connection	
	2-pole
	10-pole
	2-pole
	10-pole
End plate	
	dark beige
	Blue
End bracket	
	dark beige
	dark beige
Test adapter	
	1-pole
	stackable
	3-pole
	5-pole
Test plug	
Screwdriver	
	Standard
Identification systems	

Type	current	Qty.	Order No.
ZQV 2.5N/2	24 A	60	<b>1527540000</b>
ZQV 2.5N/10	24 A	20	<b>1527690000</b>
AEP 4C 2.5		50	<b>1521530000</b>
AEP 4C 2.5 BL		50	<b>1521640000</b>
AEB 35 SC/1		50	<b>1991920000</b>
ZEW 35		20	<b>9540000000</b>
ATPG 1.5-10 L		50	<b>1991890000</b>
ATPG 2.5 MHR		50	<b>1991960000</b>
ATPG 2.5/3		25	<b>2041190000</b>
ATPG 2.5/5		25	<b>2041180000</b>
PS 2.0 MC		20	<b>0310000000</b>
SDIL 0,6x3,5x100		1	<b>9042110000</b>
DEK 5/5 PLUS MC NE WS		1000	<b>1854490000</b>
DEK 5/5 MM WS		800	<b>2007110000</b>
WS 8/5 MM WS		800	<b>2007150000</b>
WS 10/5 M PLUS MC NE WS		600	<b>2003770000</b>

Type	current	Qty.	Order No.
ZQV 2.5N/2	24 A	60	<b>1527540000</b>
ZQV 2.5N/10	24 A	20	<b>1527690000</b>
AEP 4C 2.5		50	<b>1521530000</b>
AEP 4C 2.5 BL		50	<b>1521640000</b>
AEB 35 SC/1		50	<b>1991920000</b>
ZEW 35		20	<b>9540000000</b>
ATPG 1.5-10 L		50	<b>1991890000</b>
ATPG 2.5 MHR		50	<b>1991960000</b>
ATPG 2.5/3		25	<b>2041190000</b>
ATPG 2.5/5		25	<b>2041180000</b>
PS 2.0 MC		20	<b>0310000000</b>
SDIL 0,6x3,5x100		1	<b>9042110000</b>
DEK 5/5 PLUS MC NE WS		1000	<b>1854490000</b>
DEK 5/5 MM WS		800	<b>2007110000</b>
WS 8/5 MM WS		800	<b>2007150000</b>
WS 10/5 M PLUS MC NE WS		600	<b>2003770000</b>

For detailed information on other accessories and application in the online catalogue

All MultiMark variants (MM) = strip markers

All MultiMark variants (MM) = strip markers

Technical data  
Machinery  
Process  
Energy  
Transportation  
Device Manufacturers  
Infrastructure

Technical data

Machinery

Process

Energy

Transportation

Device Manufacturers

Infrastructure

**A2C 2.5 /DT/FS**

**2.5 mm<sup>2</sup>**

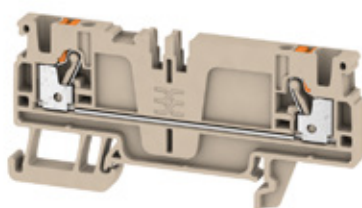

**A2C 2.5 PE /DT/FS**

**2.5 mm<sup>2</sup>**

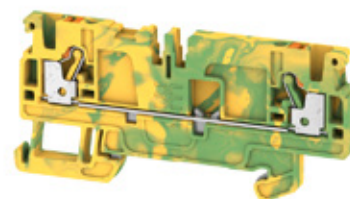

Width/Height/Depth	mm
max. current / max. cond. cross-section	A/mm <sup>2</sup>
Max. clamping range	mm <sup>2</sup>

5.1 x 77.5 x 36.5	
<b>24 / 2.5</b>	
<b>0.14...2.5</b>	

5.1 x 77.5 x 36.5	
<b>/ 2.5</b>	
<b>0.14...2.5</b>	

**Technical data**

Rated data	
Rated voltage of feed-through terminal	V
Rated current	A
for wire cross-section	mm <sup>2</sup>
Rated impulse withstand voltage / Pollution severity	
Gauge to IEC 60947-1 / UL 94 flammability rating	
Number of operating cycles	
Approvals	
Clamped conductors (H05V/H07V)	
Solid / Stranded	mm <sup>2</sup>
Flexible / Flexible with ferrule	mm <sup>2</sup>
Stripping length / Blade size	mm/-
Note	

IEC 60947-7-1

IEC	UL	CSA	EN 60079-7
800	600	600	
24	20	20	
2.5	AWG 28...12	AWG 28...12	
8 kV / 3			
A3 / V-0			

CE

Rated connection	
0.5...2.5 / 0.5...2.5	
0.5...2.5 / 0.5...2.5	
10 / 0.6 x 3.5 mm	

Approval in progress

IEC 60947-7-2

IEC	UL	CSA	EN 60079-7
	600	600	
2.5	AWG 28...12	AWG 28...12	
/ 3			
A3 / V-0			

CE

Rated connection	
0.5...2.5 / 0.5...2.5	
0.5...2.5 / 0.5...2.5	
10 / 0.6 x 3.5 mm	

Approval in progress

**Ordering data**

Version	
	dark beige
	blue
	without isolator
Note	

Type	Qty.	Order No.
A2C 2.5 /DT/FS	100	1989900000
A2C 2.5 /DT/FS BL	100	1989910000

Type	Qty.	Order No.
A2C 2.5 PE /DT/FS	50	1989890000

**Accessories**

Pluggable cross-connection	
	2-pole
	10-pole
	2-pole
	10-pole
End plate	
	dark beige
	Blue
End bracket	
	dark beige
	dark beige
Test adapter	
	1-pole
	stackable
	3-pole
	5-pole
Test plug	
Screwdriver	
	Standard
Identification systems	

Type	current	Qty.	Order No.
ZQV 2.5N/2	24 A	60	1527540000
ZQV 2.5N/10	24 A	20	1527690000
End plate			
AEP 4C 2.5		50	1521530000
AEP 4C 2.5 BL		50	1521640000
End bracket			
AEB 35 SC/1		50	1991920000
ZEW 35		20	9540000000
Test adapter			
ATPG 1.5-10 L		50	1991890000
ATPG 2.5 MHR		50	1991960000
ATPG 2.5/3		25	2041190000
ATPG 2.5/5		25	2041180000
Test plug			
PS 2.0 MC		20	0310000000
Screwdriver			
SDIL 0,6x3,5x100		1	9042110000
Identification systems			
DEK 5/5 PLUS MC NE WS		1000	1854490000
DEK 5/5 MM WS		800	2007110000
WS 8/5 MM WS		800	2007150000
WS 10/5 M PLUS MC NE WS		600	2003770000

Type	current	Qty.	Order No.
AEP 4C 2.5		50	1521530000
End bracket			
AEB 35 SC/1		50	1991920000
ZEW 35		20	9540000000
Test adapter			
ATPG 1.5-10 L		50	1991890000
ATPG 2.5 MHR		50	1991960000
ATPG 2.5/3		25	2041190000
ATPG 2.5/5		25	2041180000
Test plug			
PS 2.0 MC		20	0310000000
Screwdriver			
SDIL 0,6x3,5x100		1	9042110000
Identification systems			
DEK 5/5 PLUS MC NE WS		1000	1854490000
DEK 5/5 MM WS		800	2007110000
WS 8/5 MM WS		800	2007150000
WS 10/5 M PLUS MC NE WS		600	2003770000

For detailed information on other accessories and application in the online catalogue

All MultiMark variants (MM) = strip markers

All MultiMark variants (MM) = strip markers

**ADT 2.5 3C**

**2.5 mm<sup>2</sup>**

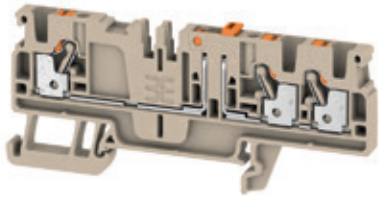

5.1 x 84.5 x 37.65  
**20 / 2.5**  
**0.14...2.5**



IEC 60947-7-1

IEC	UL	CSA	EN 60079-7
400	300	300	
20	20	20	
2.5	AWG 28...12	AWG 28...12	
6 kV / 3			
A3 / V-0			

CE

**Rated connection**

0.5...2.5 / 0.5...2.5  
 0.5...2.5 / 0.5...2.5  
 10 / 0.6 x 3.5 mm

Approval in progress

Type	Qty.	Order No.
ADT 2.5 3C	50	<b>1989830000</b>
ADT 2.5 3C BL	50	<b>1989840000</b>

Type	current	Qty.	Order No.
ZQV 2.5N/2	24 A	60	<b>1527540000</b>
ZQV 2.5N/10	24 A	20	<b>1527690000</b>

AEP DT 2.5 3C	50	<b>1989970000</b>
---------------	----	-------------------

AEB 35 SC/1	50	<b>1991920000</b>
ZEW 35	20	<b>9540000000</b>

ATPG 1.5-10 L	50	<b>1991890000</b>
ATPG 2.5 MI-R	50	<b>1991960000</b>
ATPG 2.5/3	25	<b>2041190000</b>
ATPG 2.5/5	25	<b>2041180000</b>

PS 2.0 MC	20	<b>0310000000</b>
-----------	----	-------------------

SDIL 0,6x3,5x100	1	<b>9042110000</b>
------------------	---	-------------------

DEK 5/5 PLUS MC NE WS	1000	<b>1854490000</b>
DEK 5/5 MM WS	800	<b>2007110000</b>
WS 8/5 MM WS	800	<b>2007150000</b>
WS 10/5 M PLUS MC NE WS	600	<b>2003770000</b>

All MultiMark variants (MM) = strip markers

**ADT 2.5 3C W/O DTLV**

**2.5 mm<sup>2</sup>**

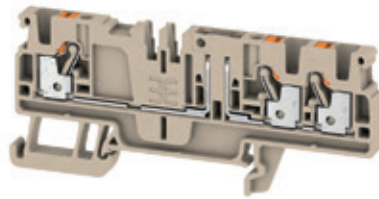

5.1 x 84.5 x 36.5  
**20 / 2.5**  
**0.14...2.5**



IEC 60947-7-1

IEC	UL	CSA	EN 60079-7
400	300	300	
20	20	20	
2.5	AWG 28...12	AWG 28...12	
6 kV / 3			
A3 / V-0			

CE

**Rated connection**

0.5...2.5 / 0.5...2.5  
 0.5...2.5 / 0.5...2.5  
 10 / 0.6 x 3.5 mm

Approval in progress

Type	Qty.	Order No.
ADT 2.5 3C W/O DTLV	50	<b>1989940000</b>

Type	current	Qty.	Order No.
ZQV 2.5N/2	24 A	60	<b>1527540000</b>
ZQV 2.5N/10	24 A	20	<b>1527690000</b>

AEP DT 2.5 3C	50	<b>1989970000</b>
---------------	----	-------------------

AEB 35 SC/1	50	<b>1991920000</b>
ZEW 35	20	<b>9540000000</b>

ATPG 1.5-10 L	50	<b>1991890000</b>
ATPG 2.5 MI-R	50	<b>1991960000</b>
ATPG 2.5/3	25	<b>2041190000</b>
ATPG 2.5/5	25	<b>2041180000</b>

PS 2.0 MC	20	<b>0310000000</b>
-----------	----	-------------------

SDIL 0,6x3,5x100	1	<b>9042110000</b>
------------------	---	-------------------

DEK 5/5 PLUS MC NE WS	1000	<b>1854490000</b>
DEK 5/5 MM WS	800	<b>2007110000</b>
WS 8/5 MM WS	800	<b>2007150000</b>
WS 10/5 M PLUS MC NE WS	600	<b>2003770000</b>

All MultiMark variants (MM) = strip markers

**ADT 2.5 4C**

**2.5 mm<sup>2</sup>**

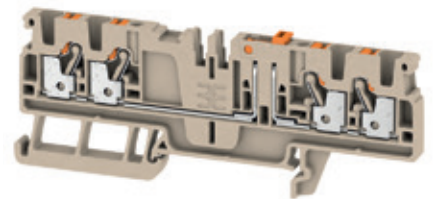

5.1 x 96 x 37.65  
**20 / 2.5**  
**0.14...2.5**



IEC 60947-7-1

IEC	UL	CSA	EN 60079-7
400	300	300	
20	20	20	
2.5	AWG 28...12	AWG 28...12	
6 kV / 3			
A3 / V-0			

CE

**Rated connection**

0.5...2.5 / 0.5...2.5  
 0.5...2.5 / 0.5...2.5  
 10 / 0.6 x 3.5 mm

Approval in progress

Type	Qty.	Order No.
ADT 2.5 4C	50	<b>1989860000</b>
ADT 2.5 4C BL	50	<b>1989870000</b>

Type	current	Qty.	Order No.
ZQV 2.5N/2	24 A	60	<b>1527540000</b>
ZQV 2.5N/10	24 A	20	<b>1527690000</b>

AEP DT 2.5 4C	50	<b>1989980000</b>
---------------	----	-------------------

AEB 35 SC/1	50	<b>1991920000</b>
ZEW 35	20	<b>9540000000</b>

ATPG 1.5-10 L	50	<b>1991890000</b>
ATPG 2.5 MI-R	50	<b>1991960000</b>
ATPG 2.5/3	25	<b>2041190000</b>
ATPG 2.5/5	25	<b>2041180000</b>

PS 2.0 MC	20	<b>0310000000</b>
-----------	----	-------------------

SDIL 0,6x3,5x100	1	<b>9042110000</b>
------------------	---	-------------------

DEK 5/5 PLUS MC NE WS	1000	<b>1854490000</b>
DEK 5/5 MM WS	800	<b>2007110000</b>
WS 8/5 MM WS	800	<b>2007150000</b>
WS 10/5 M PLUS MC NE WS	600	<b>2003770000</b>

All MultiMark variants (MM) = strip markers

Technical data

Machinery

Process

Energy

Transportation

Device Manufacturers

Infrastructure

**ADT 2.5 4C W/O DTLV**

**2.5 mm<sup>2</sup>**

**ADT 4 2C**

**4 mm<sup>2</sup>**

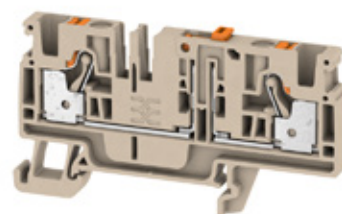
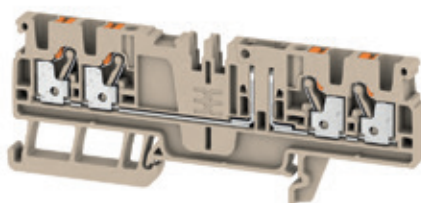

Width/Height/Depth	mm
max. current / max. cond. cross-section	A/mm <sup>2</sup>
Max. clamping range	mm <sup>2</sup>

5.1 x 96 x 36.5	
<b>20 / 2.5</b>	
<b>0.14...2.5</b>	

6.1 x 71.9 x 41.7	
<b>20 / 4</b>	
<b>0.5...4</b>	

**Technical data**

Rated data	
Rated voltage of feed-through terminal	V
Rated current	A
for wire cross-section	mm <sup>2</sup>
Rated impulse withstand voltage / Pollution severity	
Gauge to IEC 60947-1 / UL 94 flammability rating	
Number of operating cycles	
Approvals	
Clamped conductors (H05V/H07V)	
Solid / Stranded	mm <sup>2</sup>
Flexible / Flexible with ferrule	mm <sup>2</sup>
Stripping length / Blade size	mm/-
Note	

IEC 60947-7-1

IEC	UL	CSA	EN 60079-7
400	300	300	
20	20	20	
2.5	AWG 28...12	AWG 28...12	
6 kV / 3			
A3 / V-0			

CE

Rated connection	
0.5...2.5 / 0.5...2.5	
0.5...2.5 / 0.5...2.5	
10 / 0.6 x 3.5 mm	

Approval in progress

IEC/EN 60947-7-1:2009

IEC	UL	CSA	EN 60079-7
400			
20			
4			
4 kV / 3			
A4 / V-0			

Rated connection	
0.5...4 / 0.5...4	
0.5...4 / 0.5...4	
10 / 0.6 x 3.5 mm	

Approval in progress

**Ordering data**

Version	
	dark beige
	blue
	without isolator
Note	

Type	Qty.	Order No.
ADT 2.5 4C W/O DTLV	50	<b>1989950000</b>

Type	Qty.	Order No.
ADT 4 2C	50	<b>2429850000</b>
ADT 4 2C BL	50	<b>2429880000</b>

**Accessories**

Pluggable cross-connection	
	2-pole
	10-pole
	2-pole
	10-pole
End plate	
	dark beige
	Blue
End bracket	
	dark beige
	dark beige
Test adapter	
	1-pole
	stackable
	3-pole
	5-pole
Test plug	
Screwdriver	
	Standard
Identification systems	

Type	current	Qty.	Order No.
ZQV 2.5N/2	24 A	60	<b>1527540000</b>
ZQV 2.5N/10	24 A	20	<b>1527690000</b>
AEP DT 2.5 4C			
		50	<b>1989980000</b>
AEB 35 SC/1			
		50	<b>1991920000</b>
ZEW 35		20	<b>9540000000</b>
ATPG 1.5-10 L			
		50	<b>1991890000</b>
ATPG 2.5 MHR			
		50	<b>1991960000</b>
ATPG 2.5/3		25	<b>2041190000</b>
ATPG 2.5/5		25	<b>2041180000</b>
PS 2.0 MC			
		20	<b>0310000000</b>
SDIL 0,6x3,5x100			
		1	<b>9042110000</b>
DEK 5/5 PLUS MC NE WS		1000	<b>1854490000</b>
DEK 5/5 MM WS		800	<b>2007110000</b>
WS 8/5 MM WS		800	<b>2007150000</b>
WS 10/5 M PLUS MC NE WS		600	<b>2003770000</b>

Type	current	Qty.	Order No.
ZQV 4N/2	32 A	60	<b>1527930000</b>
ZQV 4N/10	32 A	20	<b>1528090000</b>
AEP 4C 4			
		20	<b>2051900000</b>
AEP 4C 4 BL			
		20	<b>2051910000</b>
AEB 35 SC/1			
		50	<b>1991920000</b>
ZEW 35		20	<b>9540000000</b>
ATPG 1.5-10 L			
		50	<b>1991890000</b>
ATPG 4 MHR			
		50	<b>1991860000</b>
PS 2.0 MC			
		20	<b>0310000000</b>
SDIL 0,6x3,5x100			
		1	<b>9042110000</b>
WS 10/6 M PLUS MC NE WS		600	<b>2003780000</b>
DEK 5/6 MM WS		600	<b>2007120000</b>
WS 8/6 MM WS		600	<b>2007160000</b>
DEK 5/6 PLUS MC NE WS		1000	<b>1011320000</b>

For detailed information on other accessories and application in the online catalogue

All MultiMark variants (MM) = strip markers

All MultiMark variants (MM) = strip markers

**APGTB 2.5 FT 2C/1**

**2.5 mm<sup>2</sup>**

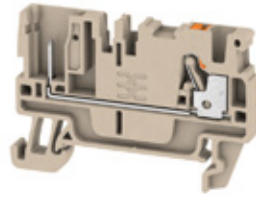

5.1 x 55 x 36.5  
**24 / 2.5**  
**0.14...2.5**



IEC 60947-7-1, IEC 61984

IEC	UL	CSA	EN 60079-7
800	600	600	
24	20	20	
2.5	AWG 28...12	AWG 28...12	
8 kV / 3			
A3 / V-0			



**Rated connection**

0.5...2.5 / 0.5...2.5  
 0.5...2.5 / 0.5...2.5  
 10 / 0.6 x 3.5 mm

Approval in progress

**APGTB 2.5 PE 2C/1**

**2.5 mm<sup>2</sup>**

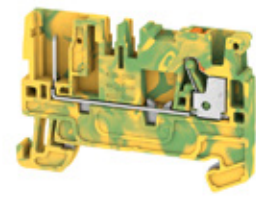

5.1 x 55 x 36.5  
**/ 2.5**  
**0.14...2.5**

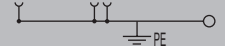

IEC 60947-7-2, IEC 61984

IEC	UL	CSA	EN 60079-7
800	600	600	
2.5	AWG 28...12	AWG 28...12	
/ 3			
A3 / V-0			



**Rated connection**

0.5...2.5 / 0.5...2.5  
 0.5...2.5 / 0.5...2.5  
 10 / 0.6 x 3.5 mm

Approval in progress

Width/Height/Depth	mm
max. current / max. cond. cross-section	A/mm <sup>2</sup>
Max. clamping range	mm <sup>2</sup>

**Technical data**

Rated data	
Rated voltage of feed-through terminal	V
Rated current	A
for wire cross-section	mm <sup>2</sup>
Rated impulse withstand voltage / Pollution severity	
Gauge to IEC 60947-1 / UL 94 flammability rating	
Number of operating cycles	
Approvals	
Clamped conductors (H05V/H07V)	
Solid / Stranded	mm <sup>2</sup>
Flexible / Flexible with ferrule	mm <sup>2</sup>
Stripping length / Blade size	mm/-

**Note**

**Ordering data**

Version	
	dark beige
	blue
	green/yellow
Note	

**Accessories**

Pluggable cross-connection	
	2-pole
	10-pole
End plate	
	dark beige
	Blue
End bracket	
	dark beige
	dark beige
Plug	
Test plug	
Screwdriver	
	Standard
Identification systems	

For detailed information on other accessories and application in the online catalogue

Type	Qty.	Order No.
APGTB 2.5 FT 2C/1	100	1513970000
APGTB 2.5 FT 2C/1 BL	100	1513990000

Type	current	Qty.	Order No.
ZQV 2.5N/2	24 A	60	1527540000
ZQV 2.5N/10	24 A	20	1527690000
AEP 2C 2.5		50	1514400000
AEP 2C 2.5 BL		50	1514420000
AEB 35 SC/1		50	1991920000
ZEW 35		20	9540000000
APG 2.5/1		50	1513720000
APG 2.5/10		20	1513770000
APG 2.5 MI		50	1513880000
APG 2.5 L		50	1513830000
APG 2.5 R		50	1513940000
PS 2.0 MC		20	0310000000
SDIL 0,6x3,5x100		1	9042110000
DEK 5/5 PLUS MC NE WS		1000	1854490000
DEK 5/5 MM WS		800	2007110000
WS 8/5 MM WS		800	2007150000
WS 10/5 M PLUS MC NE WS		600	2003770000

All MultiMark variants (MM) = strip markers

Type	Qty.	Order No.
APGTB 2.5 PE 2C/1	50	1513870000

Type	current	Qty.	Order No.
AEP 2C 2.5		50	1514400000
AEB 35 SC/1		50	1991920000
ZEW 35		20	9540000000
APG 2.5/1		50	1513720000
APG 2.5/10		20	1513770000
APG 2.5 MI		50	1513880000
APG 2.5 L		50	1513830000
APG 2.5 R		50	1513940000
PS 2.0 MC		20	0310000000
SDIL 0,6x3,5x100		1	9042110000
DEK 5/5 PLUS MC NE WS		1000	1854490000
DEK 5/5 MM WS		800	2007110000
WS 8/5 MM WS		800	2007150000
WS 10/5 M PLUS MC NE WS		600	2003770000

All MultiMark variants (MM) = strip markers

Technical data

Machinery

Process

Energy

Transportation

Device Manufacturers

Infrastructure

**APGTB 2.5 FT 3C/1**

2.5 mm<sup>2</sup>

**APGTB 2.5 PE 3C/1**

2.5 mm<sup>2</sup>

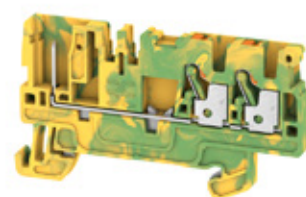
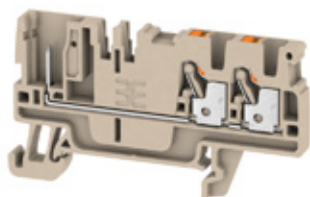

Width/Height/Depth	mm
max. current / max. cond. cross-section	A/mm <sup>2</sup>
Max. clamping range	mm <sup>2</sup>

5.1 x 66.5 x 36.5	
<b>24 / 2.5</b>	
<b>0.14...2.5</b>	

5.1 x 66.5 x 36.5	
<b>/ 2.5</b>	
<b>0.14...2.5</b>	

**Technical data**

<b>Rated data</b>	
Rated voltage of feed-through terminal	V
Rated current	A
for wire cross-section	mm <sup>2</sup>
Rated impulse withstand voltage / Pollution severity	
Gauge to IEC 60947-1 / UL 94 flammability rating	
Number of operating cycles	
Approvals	
<b>Clamped conductors (H05V/H07V)</b>	
Solid / Stranded	mm <sup>2</sup>
Flexible / Flexible with ferrule	mm <sup>2</sup>
Stripping length / Blade size	mm/-
<b>Note</b>	

IEC 60947-7-1, IEC 61984

IEC	UL	CSA	EN 60079-7
800	600	600	
24	20	20	
2.5	AWG 28...12	AWG 28...12	
8 kV / 3			
A3 / V-0			

**Rated connection**

0.5...2.5 / 0.5...2.5
0.5...2.5 / 0.5...2.5
10 / 0.6 x 3.5 mm

Approval in progress

IEC 60947-7-2, IEC 61984

IEC	UL	CSA	EN 60079-7
800	600	600	
2.5	AWG 28...12	AWG 28...12	
8 kV / 3			
A3 / V-0			

**Rated connection**

0.5...2.5 / 0.5...2.5
0.5...2.5 / 0.5...2.5
10 / 0.6 x 3.5 mm

Approval in progress

**Ordering data**

<b>Version</b>	
	dark beige
	blue
	green/yellow
<b>Note</b>	

Type	Qty.	Order No.
APGTB 2.5 FT 3C/1	50	1514000000
APGTB 2.5 FT 3C/1 BL	50	1514020000

Type	Qty.	Order No.
APGTB 2.5 PE 3C/1	50	1513890000

**Accessories**

<b>Pluggable cross-connection</b>	
	2-pole
	10-pole
<b>End plate</b>	
	dark beige
	Blue
<b>End bracket</b>	
	dark beige
	dark beige
<b>Plug</b>	
<b>Test plug</b>	
<b>Screwdriver</b>	
	Standard
<b>Identification systems</b>	

Type	current	Qty.	Order No.
ZQV 2.5N/2	24 A	60	1527540000
ZQV 2.5N/10	24 A	20	1527690000
<b>End plate</b>			
AEP 3C 2.5		50	1521510000
AEP 3C 2.5 BL		50	1521520000
<b>End bracket</b>			
AEB 35 SC/1		50	1991920000
ZEW 35		20	9540000000
<b>Plug</b>			
APG 2.5/1		50	1513720000
APG 2.5/10		20	1513770000
APG 2.5 MI		50	1513880000
APG 2.5 L		50	1513830000
APG 2.5 R		50	1513940000
<b>Test plug</b>			
<b>Screwdriver</b>			
SDIL 0,6x3,5x100		1	9042110000
<b>Identification systems</b>			
DEK 5/5 PLUS MC NE WS		1000	1854490000
DEK 5/5 MM WS		800	2007110000
WS 8/5 MM WS		800	2007150000
WS 10/5 M MC NE WS		720	1792000000

Type	current	Qty.	Order No.
AEP 3C 2.5		50	1521510000
<b>End bracket</b>			
AEB 35 SC/1		50	1991920000
ZEW 35		20	9540000000
<b>Plug</b>			
APG 2.5/1		50	1513720000
APG 2.5/10		20	1513770000
APG 2.5 MI		50	1513880000
APG 2.5 L		50	1513830000
APG 2.5 R		50	1513940000
<b>Test plug</b>			
<b>Screwdriver</b>			
SDIL 0,6x3,5x100		1	9042110000
<b>Identification systems</b>			
DEK 5/5 PLUS MC NE WS		1000	1854490000
DEK 5/5 MM WS		800	2007110000
WS 8/5 MM WS		800	2007150000
WS 10/5 M MC NE WS		720	1792000000

For detailed information on other accessories and application in the online catalogue

All MultiMark variants (MM) = strip markers

All MultiMark variants (MM) = strip markers



**APGTB 2.5 FT 4C/2**

**2.5 mm<sup>2</sup>**

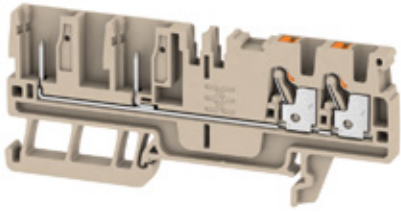

5.1 x 87 x 36.5  
24 / 2.5  
0.14...2.5



IEC 60947-7-1, IEC 61984

IEC	UL	CSA	EN 60079-7
800	600	600	
24	20	20	
2.5	AWG 28...12	AWG 28...12	
8 kV / 3			
A3 / V-0			



**Rated connection**

0.5...2.5 / 0.5...2.5  
0.5...2.5 / 0.5...2.5  
10 / 0.6 x 3.5 mm

Approval in progress

Type	Qty.	Order No.
APGTB 2.5 FT 4C/2	50	1514030000
APGTB 2.5 FT 4C/2 BL	50	1514040000

Type	current	Qty.	Order No.
ZQV 2.5N/2	24 A	60	1527540000
ZQV 2.5N/10	24 A	20	1527690000
AEP PGTB 2.5 4C/2		50	1514450000
AEP PGTB 2.5 4C/2 BL		50	1514470000
AEB 35 SC/1		50	1991920000
ZEW 35		20	9540000000
APG 2.5/1		50	1513720000
APG 2.5/10		20	1513770000
APG 2.5 MI		50	1513880000
APG 2.5 L		50	1513830000
APG 2.5 R		50	1513940000
SDIL 0,6x3,5x100		1	9042110000
DEK 5/5 PLUS MC NE WS		1000	1854490000
DEK 5/5 MM WS		800	2007110000
WS 8/5 MM WS		800	2007150000
WS 10/5 M MC NE WS		720	1792000000

All MultiMark variants (MM) = strip markers

**APGTB 2.5 PE 4C/2**

**2.5 mm<sup>2</sup>**

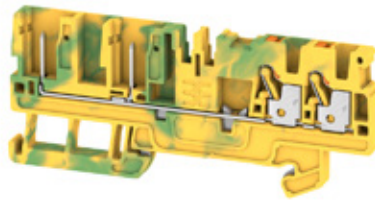

5.1 x 87 x 36.5  
/ 2.5  
0.14...2.5



IEC 60947-7-2, IEC 61984

IEC	UL	CSA	EN 60079-7
800	600	600	
2.5	AWG 28...12	AWG 28...12	
8 kV / 3			
A3 / V-0			



**Rated connection**

0.5...2.5 / 0.5...2.5  
0.5...2.5 / 0.5...2.5  
10 / 0.6 x 3.5 mm

Approval in progress

Type	Qty.	Order No.
APGTB 2.5 PE 4C/2	50	1513920000

Type	current	Qty.	Order No.
AEP PGTB 2.5 4C/2		50	1514450000
AEB 35 SC/1		50	1991920000
ZEW 35		20	9540000000
APG 2.5/1		50	1513720000
APG 2.5/10		20	1513770000
APG 2.5 MI		50	1513880000
APG 2.5 L		50	1513830000
APG 2.5 R		50	1513940000
SDIL 0,6x3,5x100		1	9042110000
DEK 5/5 PLUS MC NE WS		1000	1854490000
DEK 5/5 MM WS		800	2007110000
WS 8/5 MM WS		800	2007150000
WS 10/5 M MC NE WS		720	1792000000

All MultiMark variants (MM) = strip markers

**APGTB 2.5 2T 4C/2**

**2.5 mm<sup>2</sup>**

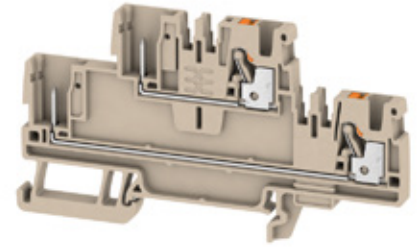

5.1 x 91 x 50.5  
24 / 2.5  
0.14...2.5



IEC 60947-7-1, IEC 61984

IEC	UL	CSA	EN 60079-7
800	600	600	
24	20	20	
2.5	AWG 28...12	AWG 28...12	
8 kV / 3			
A3 / V-0			



**Rated connection**

0.5...2.5 / 0.5...2.5  
0.5...2.5 / 0.5...2.5  
10 / 0.6 x 3.5 mm

Approval in progress

Type	Qty.	Order No.
APGTB 2.5 2T 4C/2	50	1548060000
APGTB 2.5 2T 4C/2 BL	50	1548070000

Type	current	Qty.	Order No.
ZQV 2.5N/2	24 A	60	1527540000
ZQV 2.5N/10	24 A	20	1527690000
AEP 2T 2.5		20	1547690000
AEP 2T 2.5 BL		20	1547700000
AEB 35 SC/1		50	1991920000
ZEW 35/2		20	8630740000
APG 2.5/1		50	1513720000
APG 2.5/10		20	1513770000
APG 2.5 MI		50	1513880000
APG 2.5 L		50	1513830000
APG 2.5 R		50	1513940000
PS 2.0 MC		20	0310000000
SDIL 0,6x3,5x100		1	9042110000
DEK 5/5 PLUS MC NE WS		1000	1854490000
DEK 5/5 MM WS		800	2007110000
WS 8/5 MM WS		800	2007150000
WS 10/5 M PLUS MC NE WS		600	2003770000

All MultiMark variants (MM) = strip markers

Technical data

Machinery

Process

Energy

Transportation

Device Manufacturers

Infrastructure

**APGTB 2.5 2T VL 4C/2**

**2.5 mm<sup>2</sup>**

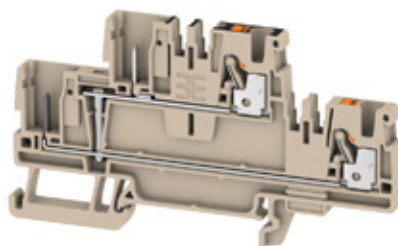

**APGTB 2.5 2T FT-PE 4C/2**

**2.5 mm<sup>2</sup>**

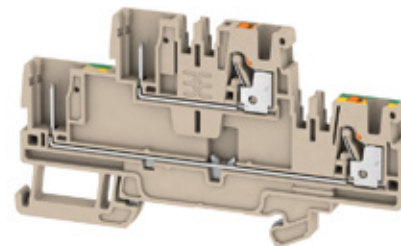

Width/Height/Depth	mm
max. current / max. cond. cross-section	A/mm <sup>2</sup>
Max. clamping range	mm <sup>2</sup>

5.1 x 91 x 50.5
<b>24 / 2.5</b>
<b>0.14...2.5</b>

5.1 x 91 x 50.5
<b>24 / 2.5</b>
<b>0.14...2.5</b>

**Technical data**

<b>Rated data</b>	
Rated voltage of feed-through terminal	V
Rated current	A
for wire cross-section	mm <sup>2</sup>
Rated impulse withstand voltage / Pollution severity	
Gauge to IEC 60947-1 / UL 94 flammability rating	
Number of operating cycles	
Approvals	
<b>Clamped conductors (H05V/H07V)</b>	
Solid / Stranded	mm <sup>2</sup>
Flexible / Flexible with ferrule	mm <sup>2</sup>
Stripping length / Blade size	mm/-
<b>Note</b>	

IEC 60947-7-1, IEC 61984

IEC	UL	CSA	EN 60079-7
800	600	600	
24	20	20	
2.5	AWG 28...12	AWG 28...12	
8 kV / 3			
A3 / V-0			

<b>Rated connection</b>	
0.5...2.5 / 0.5...2.5	
0.5...2.5 / 0.5...2.5	
10 / 0.6 x 3.5 mm	

Approval in progress

IEC 60947-7-1, IEC 60947-7-2, IEC 61984

IEC	UL	CSA	EN 60079-7
800	600		
24	20		
2.5	AWG 28...12		
8 kV / 3			
A3 / V-0			

<b>Rated connection</b>	
0.5...2.5 / 0.5...2.5	
0.5...2.5 / 0.5...2.5	
10 / 0.6 x 3.5 mm	

Approval in progress

**Ordering data**

<b>Version</b>	dark beige
	blue
	green/yellow
<b>Note</b>	

Type	Qty.	Order No.
APGTB 2.5 2T VL 4C/2	50	<b>1548140000</b>
APGTB 2.5 2T VL 4C/2 BL	50	<b>1548150000</b>

Type	Qty.	Order No.
APGTB 2.5 2T FT-PE 4C/2	50	<b>1548130000</b>

**Accessories**

<b>Pluggable cross-connection</b>	
	2-pole
	10-pole
<b>End plate</b>	
	dark beige
	blue
<b>End bracket</b>	
	dark beige
	dark beige
<b>Plug</b>	
<b>Test plug</b>	
<b>Screwdriver</b>	
	Standard
<b>Identification systems</b>	

Type	current	Qty.	Order No.
ZQV 2.5N/2	24 A	60	<b>1527540000</b>
ZQV 2.5N/10	24 A	20	<b>1527690000</b>
<b>AEP 2T 2.5</b>			
AEP 2T 2.5		20	<b>1547690000</b>
AEP 2T 2.5 BL		20	<b>1547700000</b>
<b>AEB 35 SC/1</b>			
AEB 35 SC/1		50	<b>1991920000</b>
ZEW 35/2		20	<b>8630740000</b>
APG 2.5/1		50	<b>1513720000</b>
APG 2.5/10		20	<b>1513770000</b>
APG 2.5 MI		50	<b>1513880000</b>
APG 2.5 L		50	<b>1513830000</b>
APG 2.5 R		50	<b>1513940000</b>
<b>PS 2.0 MC</b>			
PS 2.0 MC		20	<b>0310000000</b>
SDIL 0,6x3,5x100		1	<b>9042110000</b>
DEK 5/5 PLUS MC NE WS		1000	<b>1854490000</b>
DEK 5/5 MM WS		800	<b>2007110000</b>
WS 8/5 MM WS		800	<b>2007150000</b>
WS 10/5 M PLUS MC NE WS		600	<b>2003770000</b>

Type	current	Qty.	Order No.
ZQV 2.5N/2	24 A	60	<b>1527540000</b>
ZQV 2.5N/10	24 A	20	<b>1527690000</b>
<b>AEP 2T 2.5</b>			
AEP 2T 2.5		20	<b>1547690000</b>
AEP 2T 2.5 BL		20	<b>1547700000</b>
<b>AEB 35 SC/1</b>			
AEB 35 SC/1		50	<b>1991920000</b>
ZEW 35/2		20	<b>8630740000</b>
APG 2.5/1		50	<b>1513720000</b>
APG 2.5/10		20	<b>1513770000</b>
APG 2.5 MI		50	<b>1513880000</b>
APG 2.5 L		50	<b>1513830000</b>
APG 2.5 R		50	<b>1513940000</b>
<b>PS 2.0 MC</b>			
PS 2.0 MC		20	<b>0310000000</b>
SDIL 0,6x3,5x100		1	<b>9042110000</b>
DEK 5/5 PLUS MC NE WS		1000	<b>1854490000</b>
DEK 5/5 MM WS		800	<b>2007110000</b>
WS 8/5 MM WS		800	<b>2007150000</b>
WS 10/5 M PLUS MC NE WS		600	<b>2003770000</b>

For detailed information on other accessories and application in the online catalogue

All MultiMark variants (MM) = strip markers

All MultiMark variants (MM) = strip markers

APGTB 2.5 2T PE 4C/2

2.5 mm<sup>2</sup>

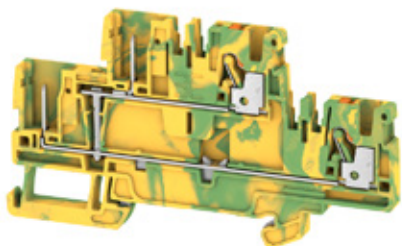

5.1 x 91 x 50.5  
/ 2.5  
0.14...2.5

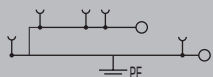

IEC 60947-7-2, IEC 61984

IEC	UL	CSA	EN 60079-7
800	600	600	
2.5	AWG 28...12	AWG 28...12	
	8 kV / 3		
	A3 / V-0		



**Rated connection**

0.5...2.5 / 0.5...2.5

0.5...2.5 / 0.5...2.5

10 / 0.6 x 3.5 mm

Approval in progress

Type	Qty.	Order No.
APGTB 2.5 2T PE 4C/2	50	1548160000

Type	current	Qty.	Order No.
ZQV 2.5N/2	24 A	60	1527540000
ZQV 2.5N/10	24 A	20	1527690000
AEP 2T 2.5		20	1547690000
AEB 35 SC/1		50	1991920000
ZEW 35/2		20	8630740000
APG 2.5/10		20	1513770000
APG 2.5 MI		50	1513880000
APG 2.5 L		50	1513830000
APG 2.5 R		50	1513940000
PS 2.0 MC		20	0310000000
SDIL 0,6x3,5x100		1	9042110000
DEK 5/5 PLUS MC NE WS		1000	1854490000
DEK 5/5 MM WS		800	2007110000
WS 8/5 MM WS		800	2007150000
WS 10/5 M PLUS MC NE WS		600	2003770000

All MultiMark variants (MM) = strip markers

Technical data

Machinery

Process

Energy

Transportation

Device Manufacturers

Infrastructure

APG 2.5...

2.5 mm<sup>2</sup>



Width/Height/Depth	mm
max. current / max. cond. cross-section	A/mm <sup>2</sup>
Max. clamping range	mm <sup>2</sup>

5.1 x 16.5 x 42.5
<b>24 / 2.5</b>
<b>0.14...2.5</b>

Technical data

Rated data	
Rated voltage	V
Max. voltage of clamp support & pluggable system	-
Rated current	A
for wire cross-section	mm <sup>2</sup>
Rated impulse withstand voltage / Pollution severity	
Gauge to IEC 60947-1 / UL 94 flammability rating	
Approvals	
Clamped conductors (H05V/H07V)	
Solid / Stranded	mm <sup>2</sup>
Flexible / Flexible with ferrule	mm <sup>2</sup>
Stripping length / Blade size	mm/-
Note	

IEC 61984

IEC	UL	CSA	EN 60079-7
800	600	600	
24	20	20	
2.5	AWG 28...12	AWG 28...12	
			8 kV / 3
			A3 / V-0

® TÜV (R)

Rated connection	Plug-in connection
0.5...2.5 / 0.5...2.5	
0.5...2.5 / 0.5...2.5	
10 / 0.6 x 3.5 mm	

Approval in progress

Ordering data

Version	
Single plates	
	Start plate
	Middle plate
	End plate
Ready pre-assembled	
	3-pin
	4-pin
	5-pin
Note	

Type	Qty.	Order No.
APG 2.5 L	50	1513830000
APG 2.5 L BL	50	1513840000
APG 2.5 L GN	50	1513850000
APG 2.5 MI	50	1513880000
APG 2.5 MI BL	50	1513900000
APG 2.5 MI GN	50	1513930000
APG 2.5 R	50	1513940000
APG 2.5 R BL	50	1513950000
APG 2.5 R GN	50	1513980000
APG 2.5/3-BG-BL-GN	25	1513820000
APG 2.5/4-3BG-GN	25	1513790000
APG 2.5/5-3BG-BL-GN	25	1513780000

Further pre-assembled plugs are available at [www.weidmueller.com](http://www.weidmueller.com)

Accessories

End plate	
	dark beige
Coding	
Cover	
Interlock	
Strain relief	
Identification systems	
For detailed information on other accessories and application in the online catalogue	

Type	current	Qty.	Order No.
AEP PG 2.5		50	2035590000
APGCE		50	1514490000
APGPC 2.5		50	1514500000
APGLE 2.5		25	2457570000
APGSR 2.5		25	2457580000
APGSR 2.5/4		25	2457590000
APGSR 2.5/8		25	2457600000
DEK 5/5 PLUS MC NE WS		1000	1854490000
DEK 5/5 MM WS		800	2007110000
WS 8/5 MM WS		800	2007150000
WS 10/5 M PLUS MC NE WS		600	2003770000

All MultiMark variants (MM) = strip markers

Technical data

Machinery

Process

Energy

Transportation

Device Manufacturers

Infrastructure



Infrastructure



Device  
Manufacturers



Transportation



Energy



Process



Machinery

Technical data

Cross-connections according to dimensions

Technical data

Machinery

Process

Energy

Transportation

Device Manufacturers

Infrastructure

ZQV 1.5N



Technical data	
current	A
Ordering data	
2-pin	
3-pin	
4-pin	
5-pin	
6-pin	
7-pin	
8-pin	
9-pin	
10-pin	
20-pin	
50-pin	

17.5			
Type	Qty.	Order No.	
ZQV 1.5N/2	60	1985410000	
ZQV 1.5N/3	60	1985480000	
ZQV 1.5N/4	60	1985490000	
ZQV 1.5N/5	20	1985500000	
ZQV 1.5N/6	20	1985510000	
ZQV 1.5N/7	20	1985520000	
ZQV 1.5N/8	20	1985540000	
ZQV 1.5N/9	20	1985560000	
ZQV 1.5N/10	20	1985580000	
ZQV 1.5N/20	20	1985600000	
ZQV 1.5N/50	5	1985620000	

ZQV 2.5N



24			
Type	Qty.	Order No.	
ZQV 2.5N/2	60	1527540000	
ZQV 2.5N/3	60	1527570000	
ZQV 2.5N/4	60	1527590000	
ZQV 2.5N/5	20	1527620000	
ZQV 2.5N/6	20	1527630000	
ZQV 2.5N/7	20	1527640000	
ZQV 2.5N/8	20	1527670000	
ZQV 2.5N/9	20	1527680000	
ZQV 2.5N/10	20	1527690000	
ZQV 2.5N/20	20	1527720000	
ZQV 2.5N/50	5	1527730000	

ZQV 4N



32			
Type	Qty.	Order No.	
ZQV 4N/2	60	1527930000	
ZQV 4N/3	60	1527940000	
ZQV 4N/4	60	1527970000	
ZQV 4N/5	60	1527980000	
ZQV 4N/6	20	1527990000	
ZQV 4N/7	20	1528020000	
ZQV 4N/8	20	1528030000	
ZQV 4N/9	20	1528070000	
ZQV 4N/10	20	1528090000	
ZQV 4N/50	5	1528130000	



Technical data	
current	A
Ordering data	
2-pin	
3-pin	
4-pin	
5-pin	
6-pin	
7-pin	
8-pin	
9-pin	
10-pin	
20-pin	
50-pin	

17.5			
Type	Qty.	Order No.	
ZQV 1.5N/2 BL	60	1985530000	
ZQV 1.5N/3 BL	60	1985550000	
ZQV 1.5N/4 BL	60	1985570000	
ZQV 1.5N/5 BL	20	1985590000	
ZQV 1.5N/6 BL	20	1985610000	
ZQV 1.5N/7 BL	20	1985630000	
ZQV 1.5N/8 BL	20	1985640000	
ZQV 1.5N/9 BL	20	1985660000	
ZQV 1.5N/10 BL	20	1985680000	
ZQV 1.5N/20 BL	20	1985700000	
ZQV 1.5N/50 BL	5	1985720000	



24			
Type	Qty.	Order No.	
ZQV 2.5N/2 BL	60	1527740000	
ZQV 2.5N/3 BL	60	1527770000	
ZQV 2.5N/4 BL	60	1527780000	
ZQV 2.5N/5 BL	20	1527790000	
ZQV 2.5N/6 BL	20	1527820000	
ZQV 2.5N/7 BL	20	1527830000	
ZQV 2.5N/8 BL	20	1527840000	
ZQV 2.5N/9 BL	20	1527870000	
ZQV 2.5N/10 BL	20	1527880000	
ZQV 2.5N/20 BL	20	1527890000	
ZQV 2.5N/50 BL	5	1527920000	



32			
Type	Qty.	Order No.	
ZQV 4N/2 BL	60	1528040000	
ZQV 4N/3 BL	60	1528080000	
ZQV 4N/4 BL	60	1528120000	
ZQV 4N/5 BL	60	1528140000	
ZQV 4N/6 BL	20	1528170000	
ZQV 4N/7 BL	20	1528180000	
ZQV 4N/8 BL	20	1528190000	
ZQV 4N/9 BL	20	1528220000	
ZQV 4N/10 BL	20	1528230000	
ZQV 4N/50 BL	5	1528240000	



Technical data	
current	A
Ordering data	
2-pin	
3-pin	
4-pin	
5-pin	
6-pin	
7-pin	
8-pin	
9-pin	
10-pin	
20-pin	
50-pin	

17.5			
Type	Qty.	Order No.	
ZQV 1.5N/2 RD	60	1985650000	
ZQV 1.5N/3 RD	60	1985670000	
ZQV 1.5N/4 RD	60	1985690000	
ZQV 1.5N/5 RD	20	1985710000	
ZQV 1.5N/6 RD	20	1985730000	
ZQV 1.5N/7 RD	20	1985750000	
ZQV 1.5N/8 RD	20	1985770000	
ZQV 1.5N/9 RD	20	1985790000	
ZQV 1.5N/10 RD	20	1985800000	
ZQV 1.5N/20 RD	20	1985810000	
ZQV 1.5N/50 RD	5	1985820000	



24			
Type	Qty.	Order No.	
ZQV 2.5N/2 RD	60	2108470000	
ZQV 2.5N/3 RD	60	2108690000	
ZQV 2.5N/4 RD	60	2108700000	
ZQV 2.5N/5 RD	20	2108710000	
ZQV 2.5N/6 RD	20	2108720000	
ZQV 2.5N/7 RD	20	2108810000	
ZQV 2.5N/8 RD	20	2108870000	
ZQV 2.5N/9 RD	20	2108900000	
ZQV 2.5N/10 RD	20	2108910000	
ZQV 2.5N/20 RD	20	2108920000	
ZQV 2.5N/50 RD	5	2109000000	



Type	Qty.	Order No.	
ZQV 4N/2 RD	60	2460450000	
ZQV 4N/3 RD	60	2460810000	
ZQV 4N/4 RD	60	2460800000	
ZQV 4N/5 RD	60	2460790000	
ZQV 4N/6 RD	20	2460780000	
ZQV 4N/7 RD	20	2460770000	
ZQV 4N/8 RD	20	2460760000	
ZQV 4N/9 RD	20	2460750000	
ZQV 4N/10 RD	20	2460740000	

ZQV 6N



41		
Type	Qty.	Order No.
ZQV 6N/2	60	1985740000
ZQV 6N/3	60	1985760000
ZQV 6N/4	60	1985780000



41		
Type	Qty.	Order No.
ZQV 6N/2 BL	60	1985830000
ZQV 6N/3 BL	60	1985840000
ZQV 6N/4 BL	60	1985850000

Type	Qty.	Order No.

Technical data

Machinery

Process

Energy

Transportation

Device Manufacturers

Infrastructure

Technical data

Machinery

Process

Energy

Transportation

Device  
Manufacturers

Infrastructure

**Test adapter**

The test adapter ATPG can be used as single plate as well as a test adapter strip for measurements. Conductors in the cross-section of 0.5 mm<sup>2</sup> up to 1.5 mm<sup>2</sup> can be connected.

By easy snapping of the test adapter into the terminal, a safe contact is realized.

Dimensions	
Width / Length / Height	mm
Stripping length	-
Rated data	
Rated voltage	V
Rated current	A
for wire cross-section	mm <sup>2</sup>
Clamped conductors (H05V/H07V)	
Solid / Stranded	mm <sup>2</sup>
Flexible / Flexible with ferrule	mm <sup>2</sup>
Ordering data	
	1-pin
	3-pin
	5-pin

**ATPG 1.5-10**

**Start plate**



3.5 / 18.5		
0.2		
1.5		
0.5...1.5		
0.5...1.5 / 0.5...1.5		
Type	Qty.	Order No.
ATPG 1.5-10 L	50	1991890000

**ATPG 1.5 MI-R**

**Middle plate or end plate**



3.5 / 18.5		
0.2		
1.5		
0.5...1.5		
0.5...1.5 / 0.5...1.5		
Type	Qty.	Order No.
ATPG 1.5 MI-R	50	1991880000

**ATPG 2.5 MI-R**

**Middle plate or end plate**



5.1 / 18.5		
0.2		
1.5		
0.5...1.5		
0.5...1.5 / 0.5...1.5		
Type	Qty.	Order No.
ATPG 2.5 MI-R	50	1991960000
ATPG 2.5/3	25	2041190000
ATPG 2.5/5	25	2041180000

**Test adapter**

The test adapter ATPG can be used as single plate as well as a test adapter strip for measurements. Conductors in the cross-section of 0.5 mm<sup>2</sup> up to 1.5 mm<sup>2</sup> can be connected.

By easy snapping of the test adapter into the terminal, a safe contact is realized.

Dimensions	
Width / Length / Height	mm
Stripping length	-
Rated data	
Rated voltage	V
Rated current	A
for wire cross-section	mm <sup>2</sup>
Clamped conductors (H05V/H07V)	
Solid / Stranded	mm <sup>2</sup>
Flexible / Flexible with ferrule	mm <sup>2</sup>
Ordering data	
	1-pin
	3-pin
	5-pin

**ATPG 4 MI-R-10**

**Middle plate or end plate**



6.1 / 18.5		
0.2		
1.5		
0.5...1.5		
0.5...1.5 / 0.5...1.5		
Type	Qty.	Order No.
ATPG 4 MI-R	50	1991860000

**ATPG 6 MI-R**

**Middle plate or end plate**



7.9 / 18.5		
0.2		
1.5		
0.5...1.5		
0.5...1.5 / 0.5...1.5		
Type	Qty.	Order No.
ATPG 6 MI-R	50	1991930000

**ATPG 10 MI-R**

**Middle plate or end plate**



9.9 / 18.5		
0.2		
1.5		
0.5...1.5		
0.5...1.5 / 0.5...1.5		
Type	Qty.	Order No.
ATPG 10 MI-R	50	1991870000





Infrastructure



Device  
Manufacturers



Transportation



Energy



Process



Machinery

Technical data

Technical data

Machinery

Process

Energy

Transportation

Device  
Manufacturers

Infrastructure

### WPD 130



### WPD 230



Width/Depth/Height
Rated AC voltage
Rated DC voltage
Rated current
UL 94 flammability rating

20 / 45 / 70
1000 V AC
1000 V DC
120 A
V-0



35,6 / 45 / 70
1000 V AC
1000 V DC
120 A
V-0



#### Technical data

<b>Inputs</b>	
Number of connections	
Solid	
Stranded	
Flexible with ferrule	
Ribbon cable	
Torque	
Clamping screw	
Stripping length	
<b>Outputs</b>	
Number of connections	
Solid	
Stranded	
Flexible with ferrule	
Torque	
Clamping screw	
Stripping length	
<b>Poles</b>	
<b>Note</b>	

IEC 60947-7-1, UL 1059, CSA

	top	mid./left	mid./mid.	mid./right	bottom
Number of connections			1		
Solid			6...10mm <sup>2</sup>		
Stranded			10...50mm <sup>2</sup>		
Flexible with ferrule			4...35mm <sup>2</sup>		
Torque			10Nm		
Clamping screw			M 10		
Stripping length			16mm		
<b>Outputs</b>					
Number of connections			1		
Solid			6...10mm <sup>2</sup>		
Stranded			10...50mm <sup>2</sup>		
Flexible with ferrule			4...35mm <sup>2</sup>		
Torque			10Nm		
Clamping screw			M 10		
Stripping length			16mm		
<b>Poles</b>					
1					
<b>Note</b>					
Rated current with Cu conductors: 150 A					

IEC 60947-7-1, UL 1059, CSA

	top	mid./left	mid./mid.	mid./right	bottom
Number of connections			2		
Solid			6...10mm <sup>2</sup>		
Stranded			10...50mm <sup>2</sup>		
Flexible with ferrule			4...35mm <sup>2</sup>		
Torque			10Nm		
Clamping screw			M 10		
Stripping length			16mm		
<b>Outputs</b>					
Number of connections			2		
Solid			6...10mm <sup>2</sup>		
Stranded			10...50mm <sup>2</sup>		
Flexible with ferrule			4...35mm <sup>2</sup>		
Torque			10Nm		
Clamping screw			M 10		
Stripping length			16mm		
<b>Poles</b>					
2					
<b>Note</b>					
Rated current with Cu conductors: 150 A					

#### Ordering data

Version	
grey	
blue	
brown	
green	
black	
<b>Note</b>	

Type	Qty.	Order No.
WPD 130 1X50/1X50 GY	9	2502530000
WPD 130 1X50/1X50 BL	9	2502540000
WPD 130 1X50/1X50 BN	9	2502560000
WPD 130 1X50/1X50 GN	9	2502550000
WPD 130 1X50/1X50 BK	9	2502570000

Type	Qty.	Order No.
WPD 230 2X50/2X50 GY	5	2502580000
WPD 230 2X50/2X50 BL	5	2502590000
WPD 230 2X50/2X50 BN	5	2502610000
WPD 230 2X50/2X50 GN	5	2502600000
WPD 230 2X50/2X50 BK	5	2502950000

## WPD 330



56.6 / 45 / 70

1000 V AC

1000 V DC

120 A

V-0

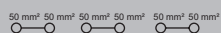

IEC 60947-7-1, UL 1059, CSA

top	mid./left	mid./mid.	mid./right	bottom
		3		
		6...10mm <sup>2</sup>		
		10...50mm <sup>2</sup>		
		4...35mm <sup>2</sup>		

		10Nm		
		M 10		
		16mm		

top	mid./left	mid./mid.	mid./right	bottom
		2		
		6...10mm <sup>2</sup>		
		10...50mm <sup>2</sup>		
		4...35mm <sup>2</sup>		
		10Nm		
		M 10		
		16mm		

3				
Rated current with Cu conductors: 150 A				

Type	Qty.	Order No.
WPD 330 3X50/3X50 3XGY	3	2502620000
WPD 330 3X50/3X50 1XBN/1XBK/1XGY	2	2502650000
WPD 330 1XGY/1XBL/1XGN	3	2502640000



Technical data

Machinery

Process

Energy

Transportation

Device  
Manufacturers

Infrastructure

### WPD 131



### WPD 231



Width/Depth/Height	25.5 / 57 / 93
Rated AC voltage	1000 V AC
Rated DC voltage	1000 V DC
Rated current	155 A
UL 94 flammability rating	V-0

Width/Depth/Height	47 / 57 / 93
Rated AC voltage	1000 V AC
Rated DC voltage	1000 V DC
Rated current	155 A
UL 94 flammability rating	V-0

#### Technical data

Inputs	
Number of connections	
Solid	
Stranded	
Flexible with ferrule	
Ribbon cable	
Torque	
Clamping screw	
Stripping length	
Outputs	
Number of connections	
Solid	
Stranded	
Flexible with ferrule	
Torque	
Clamping screw	
Stripping length	
Poles	
Note	

IEC 60947-7-1, UL 1059, CSA

	top	mid./left	mid./mid.	mid./right	bottom
Number of connections			1		
Solid			16...16mm <sup>2</sup>		
Stranded			16...95mm <sup>2</sup>		
Flexible with ferrule			10...70mm <sup>2</sup>		
Torque			19Nm		
Clamping screw			M 14		
Stripping length			26mm		
	top	mid./left	mid./mid.	mid./right	bottom
Number of connections	1		1		
Solid	1.5...10mm <sup>2</sup>		16...16mm <sup>2</sup>		
Stranded	1.5...10mm <sup>2</sup>		16...95mm <sup>2</sup>		
Flexible with ferrule	1.5...6mm <sup>2</sup>		10...70mm <sup>2</sup>		
Torque	1.2Nm		19Nm		
Clamping screw	M 4		M 14		
Stripping length	10mm		26mm		
Poles	1				
Note	Rated current with Cu conductors: 232 A				

#### Ordering data

Version	
grey	
blue	
brown	
green	
black	
Note	

Type	Qty.	Order No.
WPD 131 1X95/1X95 GY	2	2503090000
WPD 131 1X95/1X95 BL	2	2502660000
WPD 131 1X95/1X95 BN	2	2502680000
WPD 131 1X95/1X95 GN	2	2502670000
WPD 131 1X95/1X95 BK	1	2502690000
Note		

Width/Depth/Height	47 / 57 / 93
Rated AC voltage	1000 V AC
Rated DC voltage	1000 V DC
Rated current	155 A
UL 94 flammability rating	V-0

IEC 60947-7-1, UL 1059, CSA

	top	mid./left	mid./mid.	mid./right	bottom
Number of connections			2		
Solid			16...16mm <sup>2</sup>		
Stranded			16...95mm <sup>2</sup>		
Flexible with ferrule			10...70mm <sup>2</sup>		
Torque			19Nm		
Clamping screw			M 14		
Stripping length			26mm		
	top	mid./left	mid./mid.	mid./right	bottom
Number of connections	1		1		
Solid	1.5...10mm <sup>2</sup>		16...16mm <sup>2</sup>		
Stranded	1.5...10mm <sup>2</sup>		16...95mm <sup>2</sup>		
Flexible with ferrule	1.5...6mm <sup>2</sup>		10...70mm <sup>2</sup>		
Torque	1.2Nm		19Nm		
Clamping screw	M 4		M 14		
Stripping length	10mm		26mm		
Poles	2				
Note	Rated current with Cu conductors: 232 A				

Type	Qty.	Order No.
WPD 231 2X95/2X95 GY	1	2502700000
WPD 231 2X95/2X95 BL	1	2502710000
WPD 231 2X95/2X95 BN	1	2502730000
WPD 231 2X95/2X95 GN	1	2502720000
WPD 231 2X95/2X95 BK	1	2502740000
Note		

WPD 132



WPD 232



Width/Depth/Height
Rated AC voltage
Rated DC voltage
Rated current
UL 94 flammability rating

37.5 / 73.5 / 105
1000 V AC
1000 V DC
250 A
V-0



Technical data

Inputs	
Number of connections	
Solid	
Stranded	
Flexible with ferrule	
Ribbon cable	
Torque	
Clamping screw	
Stripping length	
Outputs	
Number of connections	
Solid	
Stranded	
Flexible with ferrule	
Torque	
Clamping screw	
Stripping length	
Poles	
Note	

IEC 60947-7-1, UL 1059, CSA

	top	mid./left	mid./mid.	mid./right	bottom
Number of connections			1		
Solid			95...185mm²		
Stranded			95...185mm²		
Flexible with ferrule			70...150mm²		
Torque			25Nm		
Clamping screw			M 18		
Stripping length			29mm		
	top	mid./left	mid./mid.	mid./right	bottom
Number of connections	1		1		
Solid	1.5...10mm²		95...185mm²		
Stranded	1.5...10mm²		95...185mm²		
Flexible with ferrule	1.5...6mm²		70...150mm²		
Torque	1.2Nm		25Nm		
Clamping screw	M 4		M 18		
Stripping length	10mm		29mm		
Poles	1				
Note	Rated current with Cu conductors: 353 A				

Ordering data

Version	
grey	
blue	
brown	
green	
black	
Note	

Type	Qty.	Order No.
WPD 132 1X185/1X185 GY	1	2502750000
WPD 132 1X185/1X185 BL	1	2502760000
WPD 132 1X185/1X185 BN	1	2502780000
WPD 132 1X185/1X185 GN	1	2502770000
WPD 132 1X185/1X185 BK	1	2502790000

67.6 / 73.5 / 105
1000 V AC
1000 V DC
250 A
V-0

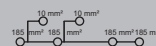

IEC 60947-7-1, UL 1059, CSA

	top	mid./left	mid./mid.	mid./right	bottom
Number of connections			2		
Solid			95...185mm²		
Stranded			95...185mm²		
Flexible with ferrule			70...150mm²		
Torque			25Nm		
Clamping screw			M 18		
Stripping length			29mm		
	top	mid./left	mid./mid.	mid./right	bottom
Number of connections	2		2		
Solid	1.5...10mm²		95...185mm²		
Stranded	1.5...10mm²		95...185mm²		
Flexible with ferrule	1.5...6mm²		70...150mm²		
Torque	1.2Nm		25Nm		
Clamping screw	M 4		M 18		
Stripping length	10mm		29mm		
Poles	2				
Note	Rated current with Cu conductors: 353 A				

Type	Qty.	Order No.
WPD 232 2X185/2X185 GY	1	2502800000
WPD 232 2X185/2X185 BL	1	2502810000
WPD 232 2X185/2X185 BN	1	2502830000
WPD 232 2X185/2X185 GN	1	2502820000
WPD 232 2X185/2X185 BK	1	2502840000



Technical data

Machinery

Process

Energy

Transportation

Device  
Manufacturers

Infrastructure

### WPD 133



### WPD 233



Width/Depth/Height	45 / 83.5 / 118
Rated AC voltage	1000 V AC
Rated DC voltage	1000 V DC
Rated current	340 A
UL 94 flammability rating	V-0

Width/Depth/Height	82.6 / 83.5 / 118
Rated AC voltage	1000 V AC
Rated DC voltage	1000 V DC
Rated current	340 A
UL 94 flammability rating	V-0



#### Technical data

Inputs	
Number of connections	
Solid	
Stranded	
Flexible with ferrule	
Ribbon cable	
Torque	
Clamping screw	
Stripping length	
Outputs	
Number of connections	
Solid	
Stranded	
Flexible with ferrule	
Torque	
Clamping screw	
Stripping length	
Poles	
Note	

IEC 60947-7-1, UL 1059, CSA

	top	mid./left	mid./mid.	mid./right	bottom
Number of connections			1		
Solid			150...300mm²		
Stranded			150...300mm²		
Flexible with ferrule			120...240mm²		
Torque			45Nm		
Clamping screw			M 24		
Stripping length			34mm		
	top	mid./left	mid./mid.	mid./right	bottom
Number of connections	1		1		
Solid	1.5...10mm²		150...300mm²		
Stranded	1.5...10mm²		150...300mm²		
Flexible with ferrule	1.5...6mm²		120...240mm²		
Torque	1.2Nm		45Nm		
Clamping screw	M 4		M 24		
Stripping length	10mm		34mm		
Poles	1				
Note	Rated current with Cu conductors: 520 A				

Width/Depth/Height	82.6 / 83.5 / 118
Rated AC voltage	1000 V AC
Rated DC voltage	1000 V DC
Rated current	340 A
UL 94 flammability rating	V-0

IEC 60947-7-1, UL 1059, CSA

	top	mid./left	mid./mid.	mid./right	bottom
Number of connections			2		
Solid			150...300mm²		
Stranded			150...300mm²		
Flexible with ferrule			120...240mm²		
Torque			45Nm		
Clamping screw			M 24		
Stripping length			34mm		
	top	mid./left	mid./mid.	mid./right	bottom
Number of connections	2		2		
Solid	1.5...10mm²		150...300mm²		
Stranded	1.5...10mm²		150...300mm²		
Flexible with ferrule	1.5...6mm²		120...240mm²		
Torque	1.2Nm		45Nm		
Clamping screw	M 4		M 24		
Stripping length	10mm		34mm		
Poles	2				
Note	Rated current with Cu conductors: 520 A				

#### Ordering data

Version	
grey	
blue	
brown	
green	
black	
Note	

Type	Qty.	Order No.
WPD 133 1X300/1X300 GY	1	2502850000
WPD 133 1X300/1X300 BL	1	2502860000
WPD 133 1X300/1X300 BN	1	2502880000
WPD 133 1X300/1X300 GN	1	2502870000
WPD 133 1X300/1X300 BK	1	2502890000
Note		

Type	Qty.	Order No.
WPD 233 2X300/2X300 GY	1	2502900000
WPD 233 2X300/2X300 BL	1	2502910000
WPD 233 2X300/2X300 BN	1	2502930000
WPD 233 2X300/2X300 GN	1	2502920000
WPD 233 2X300/2X300 BK	1	2502940000
Note		



Infrastructure



Device  
Manufacturers



Transportation



Energy



Process



Machinery

Technical data

Technical data

Machinery

Process

Energy

Transportation

Device Manufacturers

Infrastructure

**AMC 2.5**

**2.5 mm<sup>2</sup>**

**AMC 2.5 800 V**

**2.5 mm<sup>2</sup>**



Width/Height/Depth	mm
max. current / max. cond. cross-section	A/mm <sup>2</sup>
Max. clamping range	mm <sup>2</sup>

5.1 x 107 x 88.5
<b>21 / 2.5</b>
<b>0.14...2.5</b>

6.1 x 107 x 88.5
<b>21 / 2.5</b>
<b>0.14...2.5</b>

**Technical data**

Rated data	
Rated voltage	V
Rated current	A
for wire cross-section	mm <sup>2</sup>
Rated impulse withstand voltage / Pollution severity	
Gauge to IEC 60947-1 / UL 94 flammability rating	
Approvals	
Clamped conductors (H05V/H07V)	
Solid / Stranded	mm <sup>2</sup>
Flexible / Flexible with ferrule	mm <sup>2</sup>
Stripping length / Blade size	mm/-
Note	

DIN EN 60947-7-1, DIN EN 60947-7-2			
IEC	UL	CSA	EN 60079-7
690			
21			
2.5			
	8 kV / 3		
	A3 / V-0		
Rated connection			
0.5...2.5 / 0.5...2.5			
0.5...2.5 / 0.5...2.5			
10 / 0.6 x 3.5 mm			
Note			
Approval in progress			

DIN EN 60947-7-1, DIN EN 60947-7-2			
IEC	UL	CSA	EN 60079-7
800			
21			
2.5			
	8 kV / 3		
	A3 / V-0		
Rated connection			
0.5...2.5 / 0.5...2.5			
0.5...2.5 / 0.5...2.5			
10 / 0.6 x 3.5 mm			
Note			
Approval in progress			

**Ordering data**

Version	dark beige
Note	

Type	Qty.	Order No.
AMC 2.5	50	2434340000

Type	Qty.	Order No.
AMC 2.5 800V	50	2434370000

**Accessories**

Pluggable cross-connection	
	2-pole
	10-pole
Vertical jumpers	
	1-pole
End plate	
	dark beige
End bracket	
	dark beige
	dark beige
Test plug	
Screwdriver	
	Standard
Identification systems	

Type	current	Qty.	Order No.
ZQV 2.5N/2	24 A	60	1527540000
ZQV 2.5N/10	24 A	20	1527690000
ZVQ 2.5/1.5	23 A	50	1720700000
AEP MC 2.5		25	2433820000
AEB 35 SC/1		50	1991920000
ZEW 35/2		20	8630740000
PS 2.0 MC		20	0310000000
SDIL 0,6x3,5x100		1	9042110000
DEK 5/5 PLUS MC NE WS		1000	1854490000
DEK 5/5 MM WS		800	2007110000
WS 8/5 MM WS		800	2007150000
WS 10/5 M PLUS MC NE WS		600	2003770000
SNAPMARK I		50	1805880000

Type	current	Qty.	Order No.
ZVQ 2.5/1.5	23 A	50	1720700000
AEB 35 SC/1		50	1991920000
ZEW 35/2		20	8630740000
PS 2.0 MC		20	0310000000
SDIL 0,6x3,5x100		1	9042110000
DEK 5/5 PLUS MC NE WS		1000	1854490000
DEK 5/5 MM WS		800	2007110000
WS 8/5 MM WS		800	2007150000
WS 10/5 M PLUS MC NE WS		600	2003770000
SNAPMARK I		50	1805880000

For detailed information on other accessories and application in the online catalogue

All MultiMark variants (MM) = strip markers

All MultiMark variants (MM) = strip markers





Infrastructure



Device  
Manufacturers



Transportation



Energy



Process



Machinery

Technical data

AIO - sensor-actuator terminal blocks

AI021 1.5 SI

1.5 mm<sup>2</sup>

AI021 1.5 SO

1.5 mm<sup>2</sup>

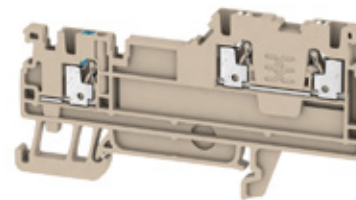
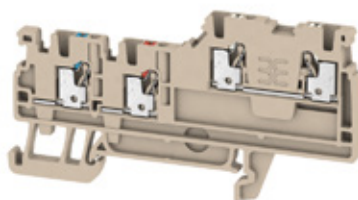

Width/Height/Depth	mm
max. current / max. cond. cross-section	A/mm <sup>2</sup>
Max. clamping range	mm <sup>2</sup>

3.5 x 80 x 42	
<b>13.5 / 1.5</b>	
<b>0.14...1.5</b>	

3.5 x 80 x 42	
<b>13.5 / 1.5</b>	
<b>0.14...1.5</b>	

Technical data

<b>Rated data</b>	
Rated voltage	V
Rated current	A
for wire cross-section	mm <sup>2</sup>
Rated impulse withstand voltage / Pollution severity	
Gauge to IEC 60947-1 / UL 94 flammability rating	
Approvals	
<b>Clamped conductors (H05V/H07V)</b>	
Solid / Stranded	mm <sup>2</sup>
Flexible / Flexible with ferrule	mm <sup>2</sup>
Stripping length / Blade size	mm/-
<b>Note</b>	

In accordance with IEC 60947-7-1

<b>IEC</b>	<b>UL</b>	<b>CSA</b>	<b>EN 60079-7</b>
250	150		
13.5	13		
1.5	AWG 26...14		
4 kV / 3			
A1 / V-0			
<b>CE</b>			
<b>Rated connection</b>			
0.5...1.5 / 0.5...1.5			
0.5...1.5 / 0.5...1.5			
8 / 0.4 x 2.0 mm			
<b>Note</b>			
Approval in progress			

In accordance with IEC 60947-7-1

<b>IEC</b>	<b>UL</b>	<b>CSA</b>	<b>EN 60079-7</b>
250	150		
13.5	13		
1.5	AWG 26...14		
4 kV / 3			
A1 / V-0			
<b>CE</b>			
<b>Rated connection</b>			
0.5...1.5 / 0.5...1.5			
0.5...1.5 / 0.5...1.5			
8 / 0.4 x 2.0 mm			
<b>Note</b>			
Approval in progress			

Ordering data

<b>Version</b>
<b>Note</b>

<b>Type</b>	<b>Qty.</b>	<b>Order No.</b>
AI021 1.5 SI	100	1992260000
<b>Note</b>		

<b>Type</b>	<b>Qty.</b>	<b>Order No.</b>
AI021 1.5 SO	100	1992240000
<b>Note</b>		

Accessories

<b>Pluggable cross-connection</b>	
	2-pole/ red
	10-pole / red
	2-pole / blue
	10-pole/ blue
<b>End plate</b>	
<b>End bracket</b>	
	dark beige
	dark beige
<b>Test adapter</b>	
	1-pole
	stackable
<b>Test plug</b>	
<b>Screwdriver</b>	
	Standard
<b>Identification systems</b>	

<b>Type</b>	<b>current</b>	<b>Qty.</b>	<b>Order No.</b>
ZQV 1.5N/2 RD	17.5 A	60	1985650000
ZQV 1.5N/10 RD	17.5 A	20	1985800000
ZQV 1.5N/2 BL	17.5 A	60	1985530000
ZQV 1.5N/10 BL	17.5 A	20	1985680000
AEP IO21		50	1993580000
AEB 35 SC/1		50	1991920000
ZEW 35		20	9540000000
ATPG 1.5-10 L		50	1991890000
ATPG 1.5 MHR		50	1991880000
PS 2.0 MC		20	0310000000
SDS 0.4X2.0X60		1	9037160000
DEK 5/3.5 MM WS		1000	2007100000
WS 8/3.5 MM WS		1000	2007140000
DEK 5/3.5 PLUS MC NE WS		1600	2003750000
WS 10/3.5 PLUS MC NE WS		960	2003760000

<b>Type</b>	<b>current</b>	<b>Qty.</b>	<b>Order No.</b>
ZQV 1.5N/2 BL	17.5 A	60	1985530000
ZQV 1.5N/10 BL	17.5 A	20	1985680000
AEP IO21		50	1993580000
AEB 35 SC/1		50	1991920000
ZEW 35		20	9540000000
ATPG 1.5-10 L		50	1991890000
ATPG 1.5 MHR		50	1991880000
PS 2.0 MC		20	0310000000
SDS 0.4X2.0X60		1	9037160000
DEK 5/3.5 MM WS		1000	2007100000
WS 8/3.5 MM WS		1000	2007140000
DEK 5/3.5 PLUS MC NE WS		1600	2003750000
WS 10/3.5 PLUS MC NE WS		960	2003760000

For detailed information on other accessories and application in the online catalogue

All MultiMark variants (MM) = strip markers

All MultiMark variants (MM) = strip markers

Technical data

Machinery

Process

Energy

Transportation

Device Manufacturers

Infrastructure

**AI021 1.5 SO-PE**

**1.5 mm<sup>2</sup>**

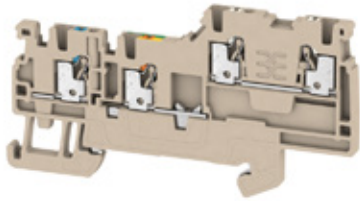

3.5 x 80 x 42  
**13.5 / 1.5**  
**0.14...1.5**

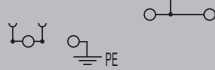

In accordance with IEC 60947-7-1

IEC	UL	CSA	EN 60079-7
250	150		
13.5	13		
1.5	AWG 26...14		
4 kV / 3			
A1 / V-0			



**Rated connection**

0.5...1.5 / 0.5...1.5  
 0.5...1.5 / 0.5...1.5  
 8 / 0.4 x 2.0 mm

Approval in progress

Type	Qty.	Order No.
AI021 1.5 SO-PE	100	<b>1992250000</b>

Type	current	Qty.	Order No.
ZQV 1.5N/2 BL	17.5 A	60	<b>1985530000</b>
ZQV 1.5N/10 BL	17.5 A	20	<b>1985680000</b>
AEP IO21		50	<b>1993580000</b>
AEB 35 SC/1		50	<b>1991920000</b>
ZEW 35		20	<b>9540000000</b>
ATPG 1.5-10 L		50	<b>1991890000</b>
ATPG 1.5 MI-R		50	<b>1991880000</b>
PS 2.0 MC		20	<b>0310000000</b>
SDS 0.4X2.0X60		1	<b>9037160000</b>
DEK 5/3.5 MM WS		1000	<b>2007100000</b>
WS 8/3.5 MM WS		1000	<b>2007140000</b>
DEK 5/3.5 PLUS MC NE WS		1600	<b>2003750000</b>
WS 10/3.5 PLUS MC NE WS		960	<b>2003760000</b>

All MultiMark variants (MM) = strip markers

**AI022 1.5 SI-PE**

**1.5 mm<sup>2</sup>**

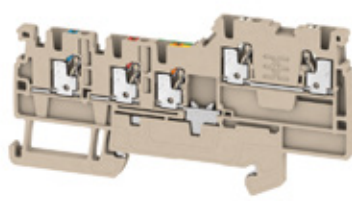

3.5 x 89 x 45  
**13.5 / 1.5**  
**0.14...1.5**

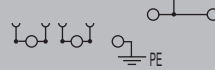

In accordance with IEC 60947-7-1

IEC	UL	CSA	EN 60079-7
250	150		
13.5	13		
1.5	AWG 26...14		
4 kV / 3			
A1 / V-0			



**Rated connection**

0.5...1.5 / 0.5...1.5  
 0.5...1.5 / 0.5...1.5  
 8 / 0.4 x 2.0 mm

Approval in progress

Type	Qty.	Order No.
AI022 1.5 SI-PE	100	<b>1992230000</b>

Type	current	Qty.	Order No.
ZQV 1.5N/2 RD	17.5 A	60	<b>1985650000</b>
ZQV 1.5N/10 RD	17.5 A	20	<b>1985800000</b>
ZQV 1.5N/2 BL	17.5 A	60	<b>1985530000</b>
ZQV 1.5N/10 BL	17.5 A	20	<b>1985680000</b>
AEP IO22		50	<b>1993590000</b>
AEB 35 SC/1		50	<b>1991920000</b>
ZEW 35		20	<b>9540000000</b>
ATPG 1.5-10 L		50	<b>1991890000</b>
ATPG 1.5 MI-R		50	<b>1991880000</b>
PS 2.0 MC		20	<b>0310000000</b>
SDS 0.4X2.0X60		1	<b>9037160000</b>
DEK 5/3.5 MM WS		1000	<b>2007100000</b>
WS 8/3.5 MM WS		1000	<b>2007140000</b>
DEK 5/3.5 PLUS MC NE WS		1600	<b>2003750000</b>
WS 10/3.5 PLUS MC NE WS		960	<b>2003760000</b>

All MultiMark variants (MM) = strip markers

**AI023 1.5 2SI**

**1.5 mm<sup>2</sup>**

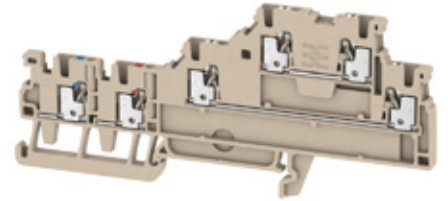

3.5 x 110 x 49.5  
**13.5 / 1.5**  
**0.14...1.5**

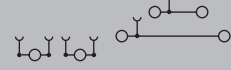

In accordance with IEC 60947-7-1

IEC	UL	CSA	EN 60079-7
250	150		
13.5	13		
1.5	AWG 26...14		
4 kV / 3			
A1 / V-0			



**Rated connection**

0.5...1.5 / 0.5...1.5  
 0.5...1.5 / 0.5...1.5  
 8 / 0.4 x 2.0 mm

Approval in progress

Type	Qty.	Order No.
AI023 1.5 2SI	50	<b>1992220000</b>

Type	current	Qty.	Order No.
ZQV 1.5N/2 RD	17.5 A	60	<b>1985650000</b>
ZQV 1.5N/10 RD	17.5 A	20	<b>1985800000</b>
ZQV 1.5N/2 BL	17.5 A	60	<b>1985530000</b>
ZQV 1.5N/10 BL	17.5 A	20	<b>1985680000</b>
AEP IO23		50	<b>1993600000</b>
AEB 35 SC/1		50	<b>1991920000</b>
ZEW 35		20	<b>9540000000</b>
ATPG 1.5-10 L		50	<b>1991890000</b>
ATPG 1.5 MI-R		50	<b>1991880000</b>
PS 2.0 MC		20	<b>0310000000</b>
SDS 0.4X2.0X60		1	<b>9037160000</b>
DEK 5/3.5 MM WS		1000	<b>2007100000</b>
WS 8/3.5 MM WS		1000	<b>2007140000</b>
DEK 5/3.5 PLUS MC NE WS		1600	<b>2003750000</b>
WS 10/3.5 PLUS MC NE WS		960	<b>2003760000</b>

All MultiMark variants (MM) = strip markers

### AAP - potential distribution terminal blocks

Potential distribution with separate fusing

#### AAP11 6 LO

6 mm<sup>2</sup>

#### AAP11 6 FE

6 mm<sup>2</sup>

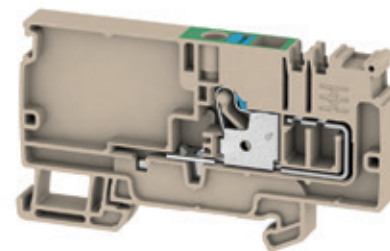
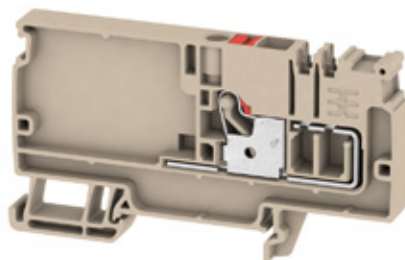

Width/Height/Depth	mm
max. current / max. cond. cross-section	A/mm <sup>2</sup>
Max. clamping range	mm <sup>2</sup>

8.1 x 85.5 x 48
<b>41 / 6</b>
<b>0.5...6</b>

8.1 x 85.5 x 48
<b>/ 6</b>
<b>0.5...6</b>

#### Technical data

<b>Rated data</b>	
Rated voltage of feed-through terminal	V
Rated current	A
for wire cross-section	mm <sup>2</sup>
Rated impulse withstand voltage / Pollution severity	
Gauge to IEC 60947-1 / UL 94 flammability rating	
Approvals	
<b>Clamped conductors (H05V/H07V)</b>	
Solid / Stranded	mm <sup>2</sup>
Flexible / Flexible with ferrule	mm <sup>2</sup>
Stripping length / Blade size	mm/-
<b>Note</b>	

In accordance with IEC 60947-7-1

IEC	UL	CSA	EN 60079-7
500	300		
41	36		
6	AWG 22...8		
6 kV / 3			
A5 / V-0			

CE

<b>Rated connection</b>			
0.5...6 / 0.5...6			
0.5...6 / 0.5...6			
12 / 1.0 x 5.5 mm			

Approval in progress

In accordance with IEC 60947-7-1

IEC	UL	CSA	EN 60079-7
500	300		
6	AWG 22...8		
6 kV / 3			
A5 / V-0			

CE

<b>Rated connection</b>			
0.5...6 / 0.5...6			
0.5...6 / 0.5...6			
12 / 1.0 x 5.5 mm			

Approval in progress

#### Ordering data

Version	
	beige Wemid / red pusher
	beige Wemid / blue pusher
	beige Wemid / orange pusher
	beige Wemid / red and blue pushers
<b>Note</b>	

Type	Qty.	Order No.
AAP11 6 LO RD	20	1989780000
AAP11 6 LO BL	20	1988130000
AAP11 6 LO OR	20	2503650000

Type	Qty.	Order No.
AAP11 6 FE	20	1988140000

FE = functional earth, contact to DIN rail.

#### Accessories

<b>Pluggable cross-connection</b>	
	2-pole/ red
	10-pole/ red
	2-pole/ blue
	10-pole/ blue
<b>End plate / Partition plate</b>	
<b>End bracket</b>	
	dark beige
	dark beige
<b>Test adapter</b>	
	1-pole
<b>Test plug</b>	
<b>Screwdriver</b>	
	Standard
<b>Identification systems</b>	

Type	current	Qty.	Order No.
ZQV 1.5N/2 RD	17.5 A	60	1985650000
ZQV 1.5N/10 RD	17.5 A	20	1985800000
ZQV 1.5N/2 BL	17.5 A	60	1985530000
ZQV 1.5N/10 BL	17.5 A	20	1985680000
AEP AP11		20	1988320000
AEB 35 SC/1		50	1991920000
ZEW 35/2		20	8630740000
ATPG 1.5-10 L		50	1991890000
PS 2.0 MC		20	0310000000
SDIL 1,0x5,5x125		1	9042130000
DEK-A 5/8 MM WS		500	2448860000
WS-A 8/8 MM WS		500	2448930000
DEK 5/8 PLUS MC NE WS		800	1046350000
WS 10/8 PLUS MC NE WS		420	1905950000

Type	current	Qty.	Order No.
ZQV 1.5N/2 BL	17.5 A	60	1985530000
ZQV 1.5N/10 BL	17.5 A	20	1985680000
AEP AP11		20	1988320000
AEB 35 SC/1		50	1991920000
ZEW 35/2		20	8630740000
ATPG 1.5-10 L		50	1991890000
PS 2.0 MC		20	0310000000
SDIL 1,0x5,5x125		1	9042130000
DEK-A 5/8 MM WS		500	2448860000
WS-A 8/8 MM WS		500	2448930000
DEK 5/8 PLUS MC NE WS		800	1046350000
WS 10/8 PLUS MC NE WS		420	1905950000

For detailed information on other accessories and application in the online catalogue

All MultiMark variants (MM) = strip markers

All MultiMark variants (MM) = strip markers

**AAP11 1.5 LI**

**1.5 mm<sup>2</sup>**

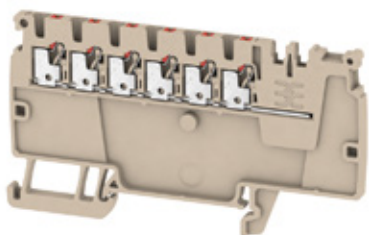

3.5 x 85.5 x 48  
**17.5 / 1.5**  
**0.14...1.5**



IEC/EN 60947-7-1:2009

IEC	UL	CSA	EN 60079-7
500	300		
17.5	13		
1.5	AWG 26...14		
6 kV / 3			
A1 / V-0			

CE

**Rated connection**

0.5...1.5 / 0.5...1.5

0.5...1.5 / 0.5...1.5

8 / 0.4 x 2.0 mm

Approval in progress

Type	Qty.	Order No.
AAP11 1.5 LI RD	50	1988160000
AAP11 1.5 LI BL	50	1988170000
AAP11 1.5 LI OR	50	2503910000

Type	current	Qty.	Order No.
ZQV 1.5N/2 RD	17.5 A	60	1985650000
ZQV 1.5N/10 RD	17.5 A	20	1985800000
ZQV 1.5N/2 BL	17.5 A	60	1985530000
ZQV 1.5N/10 BL	17.5 A	20	1985680000
AEP AP11		20	1988320000
AEB 35 SC/1		50	1991920000
ZEW 35/2		20	8630740000
SDIS 0.4X2.0X60		1	9205690000
WS 10/3.5 PLUS MC NE WS	960		2003760000
DEK 5/3.5 PLUS MC NE WS	1600		2003750000
DEK 5/3.5 MM WS	1000		2007100000
WS 8/3.5 MM WS	1000		2007140000

All MultiMark variants (MM) = strip markers

Technical data

Machinery



Process



Energy



Transportation



Device  
Manufacturers



Infrastructure



### AAP - potential distribution terminal blocks

Potential distribution with separate fusing

#### AAP13 6 LO-LO

6 mm<sup>2</sup>

#### AAP13 6 FE-LO

6 mm<sup>2</sup>

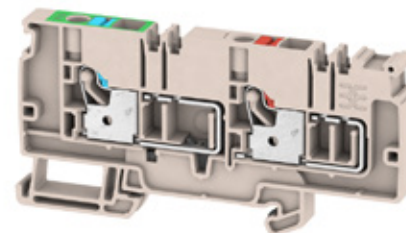
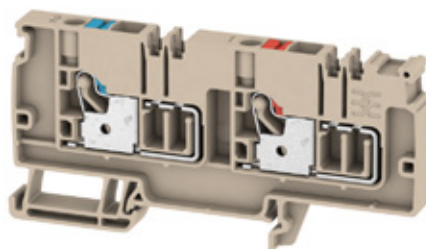

Width/Height/Depth	mm
max. current / max. cond. cross-section	A/mm <sup>2</sup>
Max. clamping range	mm <sup>2</sup>

8.1 x 96 x 48
<b>41 / 6</b>
<b>0.5...6</b>

8.1 x 96 x 48
<b>41 / 6</b>
<b>0.5...6</b>

#### Technical data

Rated data	
Rated voltage of feed-through terminal	V
Rated current	A
for wire cross-section	mm <sup>2</sup>
Rated impulse withstand voltage / Pollution severity	
Gauge to IEC 60947-1 / UL 94 flammability rating	
Approvals	
Clamped conductors (H05V/H07V)	
Solid / Stranded	mm <sup>2</sup>
Flexible / Flexible with ferrule	mm <sup>2</sup>
Stripping length / Blade size	mm/-
Note	

In accordance with IEC 60947-7-1

IEC	UL	CSA	EN 60079-7
250	150		
41	36		
6	AWG 22...8		
4 kV / 3			
A5 / V-0			
Rated connection			
0.5...6 / 0.5...6			
0.5...6 / 0.5...6			
12 / 1.0 x 5.5 mm			
Note			
Approval in progress			

In accordance with IEC 60947-7-1

IEC	UL	CSA	EN 60079-7
250	150		
41	36		
6	AWG 22...8		
4 kV / 3			
A5 / V-0			
Rated connection			
0.5...6 / 0.5...6			
0.5...6 / 0.5...6			
12 / 1.0 x 5.5 mm			
Note			
Approval in progress			

#### Ordering data

Version	
	beige Wemid / red pusher
	beige Wemid / blue pusher
	beige Wemid / orange pusher
	beige Wemid / red and blue pushers
Note	

Type	Qty.	Order No.
AAP13 6 LO-LO	20	<b>1988260000</b>

Type	Qty.	Order No.
AAP13 6 FE-LO	20	<b>1988270000</b>

FE = functional earth, contact to terminal rail.

#### Accessories

Pluggable cross-connection	
	2-pole/ red
	10-pole/ red
	2-pole/ blue
	10-pole/ blue
End plate / Partition plate	
End bracket	
	dark beige
	dark beige
Test adapter	
	1-pole
Test plug	
Screwdriver	
	Standard
Identification systems	

Type	current	Qty.	Order No.
ZQV 1.5N/2 RD	17.5 A	60	<b>1985650000</b>
ZQV 1.5N/10 RD	17.5 A	20	<b>1985800000</b>
ZQV 1.5N/2 BL	17.5 A	60	<b>1985530000</b>
ZQV 1.5N/10 BL	17.5 A	20	<b>1985680000</b>
AEP AP13		20	<b>1990140000</b>
AEB 35 SC/1		50	<b>1991920000</b>
ZEW 35/2		20	<b>8630740000</b>
ATPG 1.5-10 L		50	<b>1991890000</b>
PS 2.0 MC		20	<b>0310000000</b>
SDIL 1,0x5,5x125		1	<b>9042130000</b>
DEK-A 5/8 MM WS		500	<b>2448860000</b>
WS-A 8/8 MM WS		500	<b>2448930000</b>
DEK 5/8 PLUS MC NE WS		800	<b>1046350000</b>
WS 10/8 PLUS MC NE WS		420	<b>1905950000</b>

Type	current	Qty.	Order No.
ZQV 1.5N/2 RD	17.5 A	60	<b>1985650000</b>
ZQV 1.5N/10 RD	17.5 A	20	<b>1985800000</b>
ZQV 1.5N/2 BL	17.5 A	60	<b>1985530000</b>
ZQV 1.5N/10 BL	17.5 A	20	<b>1985680000</b>
AEP AP13		20	<b>1990140000</b>
AEB 35 SC/1		50	<b>1991920000</b>
ZEW 35/2		20	<b>8630740000</b>
ATPG 1.5-10 L		50	<b>1991890000</b>
PS 2.0 MC		20	<b>0310000000</b>
SDIL 1,0x5,5x125		1	<b>9042130000</b>
DEK-A 5/8 MM WS		500	<b>2448860000</b>
WS-A 8/8 MM WS		500	<b>2448930000</b>
DEK 5/8 PLUS MC NE WS		800	<b>1046350000</b>
WS 10/8 PLUS MC NE WS		420	<b>1905950000</b>

For detailed information on other accessories and application in the online catalogue

All MultiMark variants (MM) = strip markers

All MultiMark variants (MM) = strip markers

**AAP13 1.5 LI-LI**

**1.5 mm<sup>2</sup>**

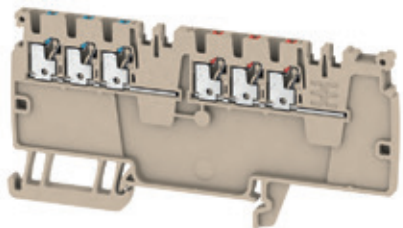

3.5 x 96 x 48  
**16 / 1.5**  
**0.14...1.5**



IEC/EN 60947-7-1:2009

IEC	UL	CSA	EN 60079-7
250	150		
16	13		
1.5	AWG 26...14		
4 kV / 3			
A1 / V-0			

CE

**Rated connection**

0.5...1.5 / 0.5...1.5

0.5...1.5 / 0.5...1.5

8 / 0.4 x 2.0 mm

Approval in progress

Type	Qty.	Order No.
AAP13 1.5 LI-LI	50	1988280000

Type	current	Qty.	Order No.
ZQV 1.5N/2 RD	17.5 A	60	1985650000
ZQV 1.5N/10 RD	17.5 A	20	1985800000
ZQV 1.5N/2 BL	17.5 A	60	1985530000
ZQV 1.5N/10 BL	17.5 A	20	1985680000
AEP AP13		20	1990140000
AEB 35 SC/1		50	1991920000
ZEW 35/2		20	8630740000
SDIS 0.4X2.0X60		1	9205690000
WS 10/3.5 PLUS MC NE WS	960		2003760000
DEK 5/3.5 PLUS MC NE WS	1600		2003750000
DEK 5/3.5 MM WS	1000		2007100000
WS 8/3.5 MM WS	1000		2007140000

All MultiMark variants (MM) = strip markers

Technical data

Machinery

Process

Energy

Transportation

Device Manufacturers

Infrastructure

**AAP - potential distribution terminal blocks**

Potential distribution with separate fusing

**AAP12 10 LO**

**10 mm<sup>2</sup>**

**AAP12 10 FE**

**10 mm<sup>2</sup>**

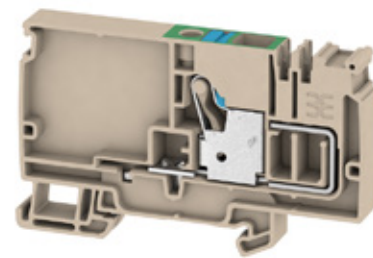
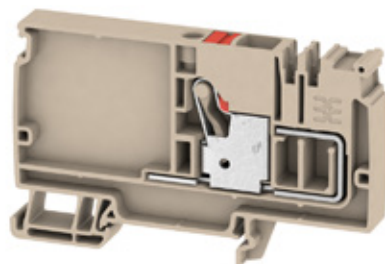

Width/Height/Depth	mm
max. current / max. cond. cross-section	A/mm <sup>2</sup>
Max. clamping range	mm <sup>2</sup>

10 x 89 x 54
<b>57 / 10</b>
<b>0.5...10</b>

10 x 89 x 54
<b>/ 10</b>
<b>0.5...10</b>

**Technical data**

<b>Rated data</b>	
Rated voltage of feed-through terminal	V
Rated current	A
for wire cross-section	mm <sup>2</sup>
Rated impulse withstand voltage / Pollution severity	
Gauge to IEC 60947-1 / UL 94 flammability rating	
Approvals	
<b>Clamped conductors (H05V/H07V)</b>	
Solid / Stranded	mm <sup>2</sup>
Flexible / Flexible with ferrule	mm <sup>2</sup>
Stripping length / Blade size	mm/-
<b>Note</b>	

In accordance with IEC 60947-7-1

IEC	UL	CSA	EN 60079-7
800	600		
57	51		
10	AWG 20...6		
8 kV / 3			
A6 / V-0			

CE

<b>Rated connection</b>			
0.5...10 / 0.5...10			
0.5...10 / 0.5...10			
18 / 1.0 x 5.5 mm			

Approval in progress

In accordance with IEC 60947-7-1

IEC	UL	CSA	EN 60079-7
800	600		
10	AWG 20...6		
8 kV / 3			
A6 / V-0			

CE

<b>Rated connection</b>			
0.5...10 / 0.5...10			
0.5...10 / 0.5...10			
18 / 1.0 x 5.5 mm			

Approval in progress

**Ordering data**

<b>Version</b>	
	beige Wemid / red pusher
	beige Wemid / blue pusher
	beige Wemid / orange pusher
	beige Wemid / red and blue pushers
<b>Note</b>	

Type	Qty.	Order No.
AAP12 10 LO RD	20	<b>1988190000</b>
AAP12 10 LO BL	20	<b>1988180000</b>
AAP12 10 LO OR	20	<b>2503900000</b>

Type	Qty.	Order No.
AAP12 10 FE	20	<b>1988200000</b>

FE = functional earth, contact to DIN rail.

**Accessories**

<b>Pluggable cross-connection</b>	
	2-pole/ red
	10-pole / red
	2-pole / blue
	10-pole/ blue
<b>End plate / Partition plate</b>	
<b>End bracket</b>	
	dark beige
	dark beige
<b>Test adapter</b>	
	1-pole
<b>Test plug</b>	
<b>Screwdriver</b>	
	Standard
<b>Identification systems</b>	

Type	current	Qty.	Order No.
ZQV 2.5N/2 RD	24 A	60	<b>2108470000</b>
ZQV 2.5N/10 RD	24 A	20	<b>2108910000</b>
ZQV 2.5N/2 BL	24 A	60	<b>1527740000</b>
ZQV 2.5N/10 BL	24 A	20	<b>1527880000</b>
AEP AP12		20	<b>1988300000</b>
AEB 35 SC/1		50	<b>1991920000</b>
ZEW 35/2		20	<b>8630740000</b>
ATPG 1.5-10 L		50	<b>1991890000</b>
PS 2.0 MC		20	<b>0310000000</b>
SDIL 1,0x5,5x125		1	<b>9042130000</b>
WS 7.8/9.2 PLUS MC NE GR		360	<b>1208970000</b>

Type	current	Qty.	Order No.
ZQV 2.5N/2 BL	24 A	60	<b>1527740000</b>
ZQV 2.5N/10 BL	24 A	20	<b>1527880000</b>
AEP AP12		20	<b>1988300000</b>
AEB 35 SC/1		50	<b>1991920000</b>
ZEW 35/2		20	<b>8630740000</b>
ATPG 1.5-10 L		50	<b>1991890000</b>
PS 2.0 MC		20	<b>0310000000</b>
SDIL 1,0x5,5x125		1	<b>9042130000</b>
WS 7.8/9.2 PLUS MC NE GR		360	<b>1208970000</b>

For detailed information on other accessories and application in the online catalogue

All MultiMark variants (MM) = strip markers

All MultiMark variants (MM) = strip markers

Technical data

Machinery

Process

Energy

Transportation

Device Manufacturers

Infrastructure



**AAP12 2.5 LI**

**2.5 mm<sup>2</sup>**

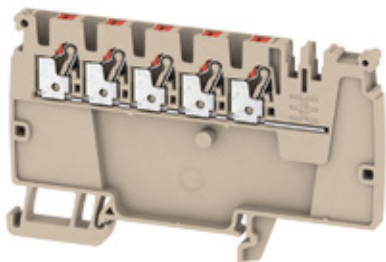

5.1 x 89 x 54  
**24 / 2.5**  
**0.5...2.5**



IEC/EN 60947-7-1:2009

IEC	UL	CSA	EN 60079-7
800	600		
24	20		
2.5	AWG 28...12		
8 kV / 3			
A3 / V-0			

CE

**Rated connection**

0.5...2.5 / 0.5...2.5  
 0.5...2.5 / 0.5...2.5  
 10 / 0.6 x 3.5 mm

Approval in progress

Type	Qty.	Order No.
AAP12 2.5 LI RD	50	1988290000
AAP12 2.5 LI BL	50	1988100000
AAP12 2.5 LI OR	50	2503880000

Type	current	Qty.	Order No.
ZQV 2.5N/2 RD	24 A	60	2108470000
ZQV 2.5N/10 RD	24 A	20	2108910000
ZQV 2.5N/2 BL	24 A	60	1527740000
ZQV 2.5N/10 BL	24 A	20	1527880000
AEP AP12		20	1988300000
AEB 35 SC/1		50	1991920000
ZEW 35/2		20	8630740000
SDIL 0,6x3,5x100		1	9042110000
DEK 5/5 PLUS MC NE WS		1000	1854490000
WS 10/5 M PLUS MC NE WS		600	2003770000
DEK 5/5 MM WS		800	2007110000
WS 8/5 MM WS		800	2007150000

All MultiMark variants (MM) = strip markers

Technical data

Machinery

Process

Energy

Transportation

Device Manufacturers

Infrastructure

**AAP - potential distribution terminal blocks**

Potential distribution with separate fusing

**AAP14 10 LO-LO**

**10 mm<sup>2</sup>**

**AAP14 10 FE-LO**

**10 mm<sup>2</sup>**

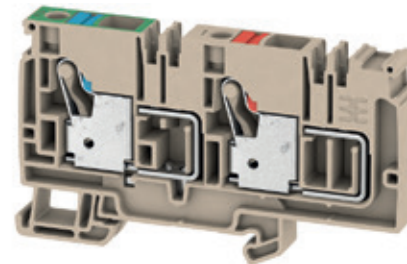
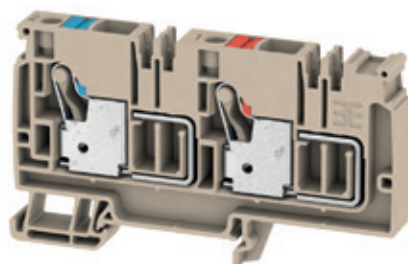

Width/Height/Depth	mm
max. current / max. cond. cross-section	A/mm <sup>2</sup>
Max. clamping range	mm <sup>2</sup>

10 x 94 x 54	
<b>57 / 10</b>	
<b>0.5...10</b>	

10 x 94 x 54	
<b>57 / 10</b>	
<b>0.5...10</b>	

**Technical data**

<b>Rated data</b>	
Rated voltage of feed-through terminal	V
Rated current	A
for wire cross-section	mm <sup>2</sup>
Rated impulse withstand voltage / Pollution severity	
Gauge to IEC 60947-1 / UL 94 flammability rating	
Approvals	
<b>Clamped conductors (H05V/H07V)</b>	
Solid / Stranded	mm <sup>2</sup>
Flexible / Flexible with ferrule	mm <sup>2</sup>
Stripping length / Blade size	mm/-
<b>Note</b>	

In accordance with IEC 60947-7-1

IEC	UL	CSA	EN 60079-7
500	150		
57	51		
10	AWG 20...6		
6 kV / 3			
A6 / V-0			

CE

Rated connection	
0.5...10 / 0.5...10	
0.5...10 / 0.5...10	
18 / 1.0 x 5.5 mm	

Approval in progress

In accordance with IEC 60947-7-1

IEC	UL	CSA	EN 60079-7
500	150		
57	51		
10	AWG 20...6		
6 kV / 3			
A6 / V-0			

CE

Rated connection	
0.5...10 / 0.5...10	
0.5...10 / 0.5...10	
18 / 1.0 x 5.5 mm	

Approval in progress

**Ordering data**

Version	
	beige Wemid / red pusher
	beige Wemid / blue pusher
	beige Wemid / orange pusher
	beige Wemid / red and blue pushers
<b>Note</b>	

Type	Qty.	Order No.
AAP14 10 LO-LO	20	<b>1988250000</b>

Type	Qty.	Order No.
AAP14 10 FE-LO	20	<b>1988240000</b>

FE = functional earth, contact to terminal rail

**Accessories**

Pluggable cross-connection	
	2-pole/ red
	10-pole / red
	2-pole / blue
	10-pole/ blue
End plate / Partition plate	
End bracket	
	dark beige
	dark beige
Test adapter	
	1-pole
Test plug	
Screwdriver	
	Standard
Identification systems	

Type	current	Qty.	Order No.
ZQV 2.5N/2 RD	24 A	60	<b>2108470000</b>
ZQV 2.5N/10 RD	24 A	20	<b>2108910000</b>
ZQV 2.5N/2 BL	24 A	60	<b>1527740000</b>
ZQV 2.5N/10 BL	24 A	20	<b>1527880000</b>
AEP AP14		20	<b>1988340000</b>
AEB 35 SC/1		50	<b>1991920000</b>
ZEW 35/2		20	<b>8630740000</b>
ATPG 1.5-10 L		50	<b>1991890000</b>
PS 2.0 MC		20	<b>0310000000</b>
SDIL 1,0x5,5x125		1	<b>9042130000</b>
WS 7.8/9.2 PLUS MC NE GR		360	<b>1208970000</b>

Type	current	Qty.	Order No.
ZQV 2.5N/2 RD	24 A	60	<b>2108470000</b>
ZQV 2.5N/10 RD	24 A	20	<b>2108910000</b>
ZQV 2.5N/2 BL	24 A	60	<b>1527740000</b>
ZQV 2.5N/10 BL	24 A	20	<b>1527880000</b>
AEP AP14		20	<b>1988340000</b>
AEB 35 SC/1		50	<b>1991920000</b>
ZEW 35/2		20	<b>8630740000</b>
ATPG 1.5-10 L		50	<b>1991890000</b>
PS 2.0 MC		20	<b>0310000000</b>
SDIL 1,0x5,5x125		1	<b>9042130000</b>
WS 7.8/9.2 PLUS MC NE GR		360	<b>1208970000</b>

For detailed information on other accessories and application in the online catalogue

All MultiMark variants (MM) = strip markers

All MultiMark variants (MM) = strip markers

Technical data

Machinery

Process

Energy

Transportation

Device Manufacturers

Infrastructure

**AAP14 2.5 LI-LI**

**2.5 mm<sup>2</sup>**

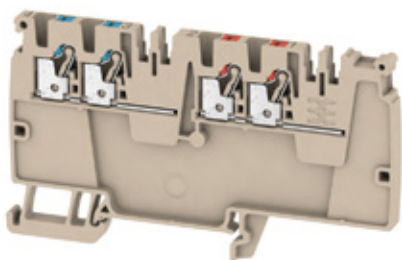

5.1 x 94 x 54  
**24 / 2.5**  
**0.5...2.5**



IEC/EN 60947-7-1:2009

IEC	UL	CSA	EN 60079-7
500	150		
24	20		
2.5	AWG 28...12		
6 kV / 3			
A3 / V-0			

CE

**Rated connection**

0.5...2.5 / 0.5...2.5

0.5...2.5 / 0.5...2.5

10 / 0.6 x 3.5 mm

Approval in progress

Type	Qty.	Order No.
AAP14 2.5 LI-LI	50	1988230000

Type	current	Qty.	Order No.
ZQV 2.5N/2 RD	24 A	60	2108470000
ZQV 2.5N/10 RD	24 A	20	2108910000
ZQV 2.5N/2 BL	24 A	60	1527740000
ZQV 2.5N/10 BL	24 A	20	1527880000
AEP AP14		20	1988340000
AEB 35 SC/1		50	1991920000
ZEW 35/2		20	8630740000
SDIL 0,6x3,5x100		1	9042110000
DEK 5/5 PLUS MC NE WS		1000	1854490000
WS 10/5 M PLUS MC NE WS		600	2003770000
DEK 5/5 MM WS		800	2007110000
WS 8/5 MM WS		800	2007150000

All MultiMark variants (MM) = strip markers

Technical data

Machinery



Process



Energy



Transportation



Device  
Manufacturers



Infrastructure



### AAP - potential distribution terminal blocks

Potential distribution with integrated fusing

#### AAP21 10 LO

10 mm<sup>2</sup>

#### AAP21 10 FE

10 mm<sup>2</sup>

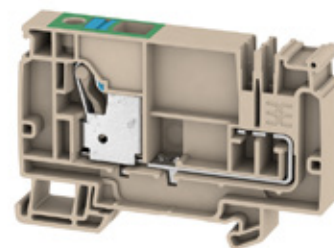
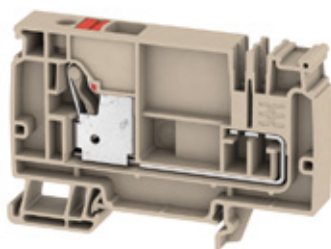

Width/Height/Depth	mm
max. current / max. cond. cross-section	A/mm <sup>2</sup>
Max. clamping range	mm <sup>2</sup>

12 x 82 x 54
<b>57 / 10</b>
<b>0.5...10</b>

12 x 82 x 54
<b>/ 10</b>
<b>0.5...10</b>

#### Technical data

Rated data	
Rated voltage of feed-through terminal	V
Rated current	A
for wire cross-section	mm <sup>2</sup>
Rated impulse withstand voltage / Pollution severity	
Gauge to IEC 60947-1 / UL 94 flammability rating	
Approvals	
Clamped conductors (H05V/H07V)	
Solid / Stranded	mm <sup>2</sup>
Flexible / Flexible with ferrule	mm <sup>2</sup>
Stripping length / Blade size	mm/-
Note	

In accordance with IEC 60947-7-1

IEC	UL	CSA	EN 60079-7
250			
57			
10			
	4 kV / 3		
	A6 / V-0		

Rated connection	
0.5...10 / 0.5...10	
0.5...10 / 0.5...10	
18 / 1.0 x 5.5 mm	

Approval in progress

In accordance with IEC 60947-7-1

IEC	UL	CSA	EN 60079-7
250			
10			
	4 kV / 3		
	A6 / V-0		

Rated connection	
0.5...10 / 0.5...10	
0.5...10 / 0.5...10	
18 / 1.0 x 5.5 mm	

Approval in progress

#### Ordering data

Version	
	beige Wemid / red pusher
	beige Wemid / blue pusher
	beige Wemid / orange pusher
	beige Wemid / red and blue pushers
Note	

Type	Qty.	Order No.
AAP21 10 LO RD	20	2428910000
AAP21 10 LO BL	20	2428940000

Type	Qty.	Order No.
AAP21 10 FE	20	2428920000

Functional earth (FE), contact to terminal rail

#### Accessories

Pluggable cross-connection	
	2-pole/ red
	10-pole / red
	2-pole / blue
	10-pole/ blue
End plate / Partition plate	
End bracket	
	dark beige
	dark beige
Test adapter	
	1-pole
Test plug	
Screwdriver	
	Standard
Identification systems	

Type	current	Qty.	Order No.
ZQV 4N/2 RD		60	2460450000
ZQV 4N/10 RD		20	2460740000
ZQV 4N/2 BL	32 A	60	1528040000
ZQV 4N/10 BL	32 A	20	1528230000
AEP AP21		20	2429020000
AEB 35 SC/1		50	1991920000
ZEW 35/2		20	8630740000
ATPG 1.5-10 L		50	1991890000
PS 2.0 MC		20	0310000000
SDIL 1,0x5,5x125		1	9042130000
WS 7.8/9.2 PLUS MC NE GR		360	1208970000

Type	current	Qty.	Order No.
ZQV 4N/2 BL	32 A	60	1528040000
ZQV 4N/10 BL	32 A	20	1528230000
AEP AP21		20	2429020000
AEB 35 SC/1		50	1991920000
ZEW 35/2		20	8630740000
ATPG 1.5-10 L		50	1991890000
PS 2.0 MC		20	0310000000
SDIL 1,0x5,5x125		1	9042130000
WS 7.8/9.2 PLUS MC NE GR		360	1208970000

For detailed information on other accessories and application in the online catalogue

All MultiMark variants (MM) = strip markers

All MultiMark variants (MM) = strip markers

**AAP21 4 LI**

**4 mm<sup>2</sup>**

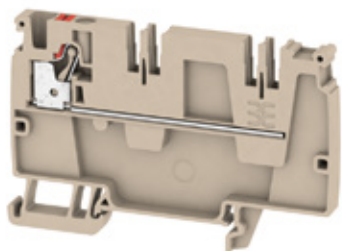

6.1 x 82 x 54  
**32 / 4**  
**0.5...4**

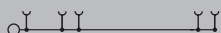

In accordance with IEC 60947-7-1

IEC	UL	CSA	EN 60079-7
250			
32			
4			
	4 kV / 3		
	A4 / V-0		

Rated connection
0.5...4 / 0.5...4
0.5...4 / 0.5...4
12 / 0.6 x 3.5 mm
Approval in progress

Type	Qty.	Order No.
AAP21 4 LI RD	50	2428930000
AAP21 4 LI BL	50	2428960000

Type	current	Qty.	Order No.
ZQV 4N/2 RD		60	2460450000
ZQV 4N/10 RD		20	2460740000
ZQV 4N/2 BL	32 A	60	1528040000
ZQV 4N/10 BL	32 A	20	1528230000
AEP AP21		20	2429020000
AEB 35 SC/1		50	1991920000
ZEW 35/2		20	8630740000
ATPG 1.5-10 L		50	1991890000
PS 2.0 MC		20	0310000000
SDIL 0,6x3,5x100		1	9042110000
WS 10/6 M PLUS MC NE WS	600		2003780000
DEK 5/6 PLUS MC NE WS	1000		1011320000
DEK 5/6 MM WS	600		2007120000
WS 8/6 MM WS	600		2007160000

All MultiMark variants (MM) = strip markers

Technical data

Machinery

Process

Energy

Transportation

Device Manufacturers

Infrastructure

### AAP - potential distribution terminal blocks

Potential distribution with integrated fusing

#### AAP21 4 FS

4 mm<sup>2</sup>

#### AAP21 4 DT

4 mm<sup>2</sup>

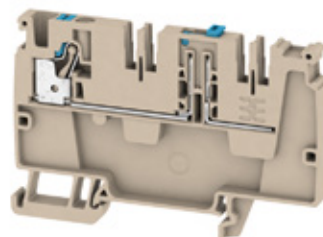
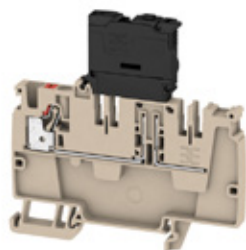

Width/Height/Depth	mm
max. current / max. cond. cross-section	A/mm <sup>2</sup>
Max. clamping range	mm <sup>2</sup>

6.1 x 82 x 82
<b>6.3 / 4</b>
<b>0.5...4</b>

6.1 x 82 x 55.5
<b>20 / 4</b>
<b>0.5...4</b>

#### Technical data

Rated data	
Rated voltage to adjoining terminal	V
Rated current	A
for wire cross-section	mm <sup>2</sup>
Rated impulse withstand voltage / Pollution severity	
UL 94 flammability rating	
Approvals	
Clamped conductors (H05V/H07V)	
Solid / Stranded	mm <sup>2</sup>
Flexible / Flexible with ferrule	mm <sup>2</sup>
Stripping length	
Blade size	
Note	

In accordance with IEC 60947-7-3

IEC	UL	CSA	EN 60079-7
250			
6.3			
4			
		4 kV / 3	
		V-0	

Rated connection		
0.5...4 / 0.5...4		
0.5...4 / 0.5...4		
12 mm		
0.6 x 3.5 mm		

Approval in progress

In accordance with IEC 60947-7-1

IEC	UL	CSA	EN 60079-7
250			
20			
4			
		4 kV / 3	
		V-0	

Rated connection		
0.5...4 / 0.5...4		
0.5...4 / 0.5...4		
12 mm		
0.6 x 3.5 mm		

Approval in progress

#### Ordering data

Version	
250 V AC/DC, without LED	
10-36 V AC/DC, with LED	
30-70 V AC/DC, with LED	
60-150 V AC/DC, with LED	
100-250 V AC/DC, with LED	
beige Wemid / blue pusher	
Note	

Type	Qty.	Order No.
AAP21 4 FS	50	2428950000
AAP21 4 FS 10-36V	50	2458990000
AAP21 4 FS 30-70V	50	2460200000
AAP21 4 FS 60-150V	50	2460190000
AAP21 4 FS 100-250V	50	2460180000

Type	Qty.	Order No.
AAP21 4 DT	50	2428980000

#### Accessories

Pluggable cross-connection	
2-pole/ red	
10-pole / red	
2-pole / blue	
10-pole/ blue	
End plate / Partition plate	
End bracket	
dark beige	
dark beige	
Test plug	
Screwdriver	
Standard	
Identification systems	
G-fuse cartridge, 5 x 20 mm (IEC 60127-2)	
0.25 A fast	
0.50 A fast	
1.00 A fast	
2.00 A fast	

Type	current	Qty.	Order No.
ZQV 4N/2 RD		60	2460450000
ZQV 4N/10 RD		20	2460740000
AEP AP21		20	2429020000
AEB 35 SC/1		50	1991920000
ZEW 35/2		20	8630740000
PS 2.0 MC		20	0310000000
SDIL 0,6x3,5x100		1	9042110000
WS 10/6 M PLUS MC NE WS		600	2003780000
DEK 5/6 MM WS		600	2007120000
WS 8/6 MM WS		600	2007160000
DEK 5/6 PLUS MC NE WS		1000	1011320000
G 20/0.25A/F		10	0430500000
G 20/0.50A/F		10	0430600000
G 20/1.00A/F		10	0430700000
G 20/2.00A/F		10	0430900000

Type	current	Qty.	Order No.
ZQV 4N/2 BL	32 A	60	1528040000
ZQV 4N/10 BL	32 A	20	1528230000
AEP AP21		20	2429020000
AEB 35 SC/1		50	1991920000
ZEW 35/2		20	8630740000
SDIL 0,6x3,5x100		1	9042110000
WS 10/6 M PLUS MC NE WS		600	2003780000
DEK 5/6 MM WS		600	2007120000
WS 8/6 MM WS		600	2007160000
DEK 5/6 PLUS MC NE WS		1000	1011320000

For detailed information on other accessories and application in the online catalogue

All MultiMark variants (MM) = strip markers

All MultiMark variants (MM) = strip markers

**Clear, compact construction of control voltage distribution**

Example configuration of potential distribution terminal block with fusing

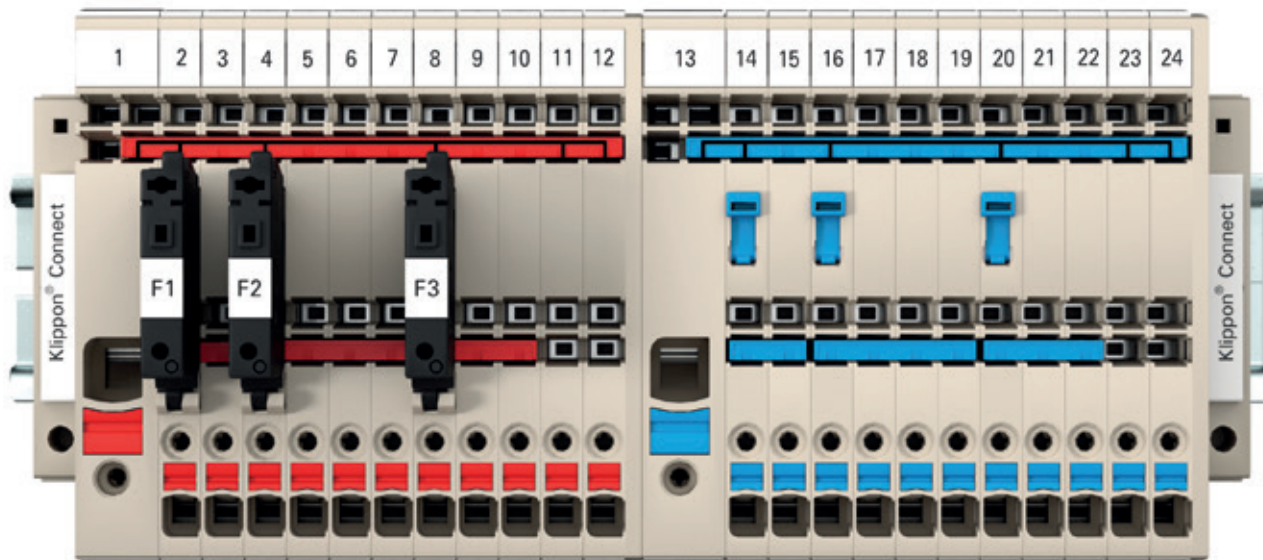

- Group fusing through breakaway of individual poles in the cross-connections
- Groups can be switched potential-free via a disconnector
- Direct potential distribution possible without fusing within the structure

**Schematic representation of circuit diagram**

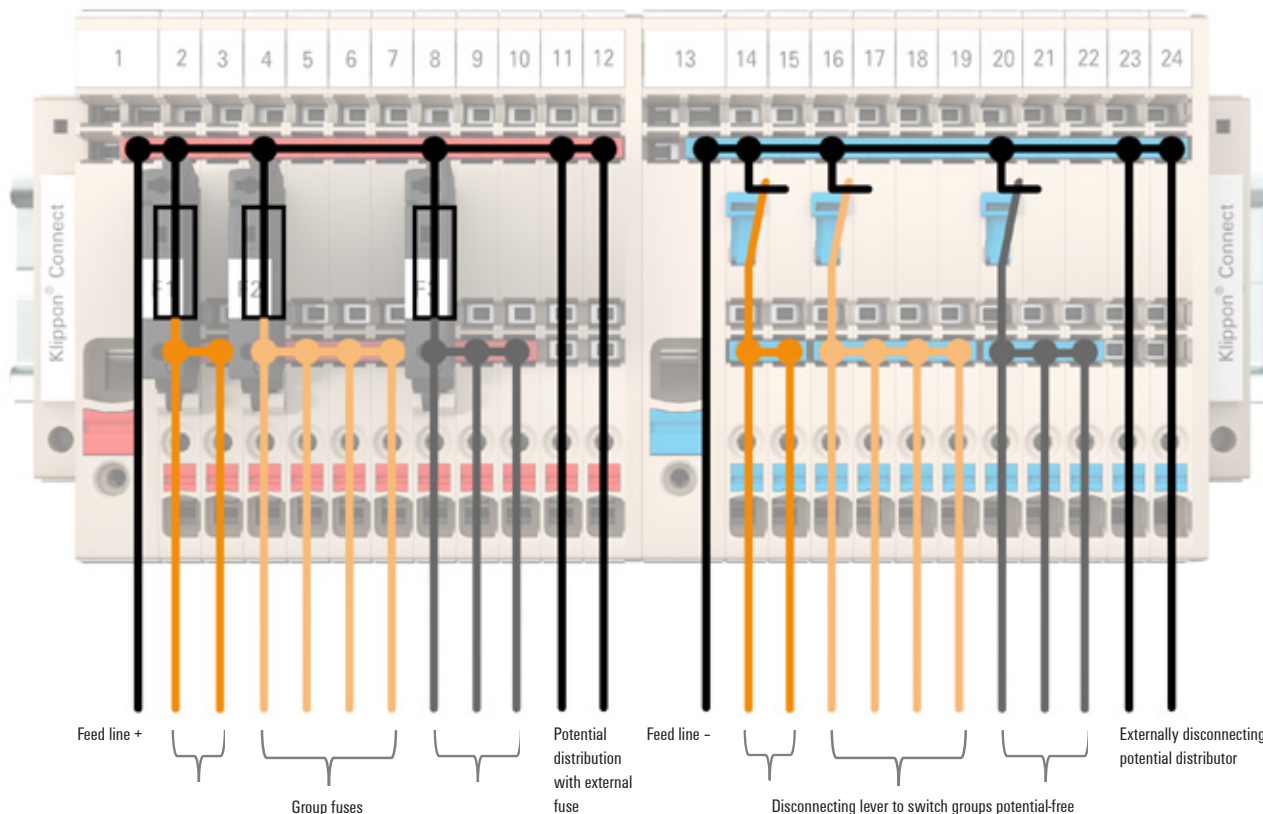

Technical data

Machinery

Process

Energy

Transportation

Device Manufacturers

Infrastructure

**AAP - potential distribution terminal blocks**

Potential distribution with integrated fusing

**AAP22 10 LO-LO**

**10 mm<sup>2</sup>**

**AAP22 10 FE-LO**

**10 mm<sup>2</sup>**

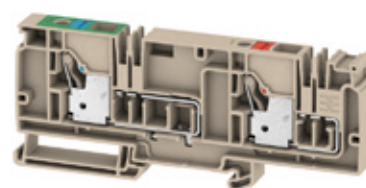
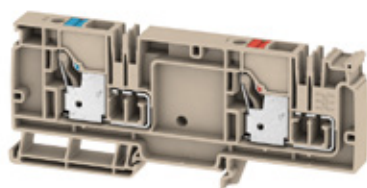

Width/Height/Depth	mm
max. current / max. cond. cross-section	A/mm <sup>2</sup>
Max. clamping range	mm <sup>2</sup>

12 x 129 x 54
<b>57 / 10</b>
<b>0.5...10</b>

12 x 129 x 54
<b>17 / 10</b>
<b>0.5...10</b>

**Technical data**

Rated data	
Rated voltage of feed-through terminal	V
Rated current	A
for wire cross-section	mm <sup>2</sup>
Rated impulse withstand voltage / Pollution severity	
Gauge to IEC 60947-1 / UL 94 flammability rating	
Number of operating cycles	
Approvals	
Clamped conductors (H05V/H07V)	
Solid / Stranded	mm <sup>2</sup>
Flexible / Flexible with ferrule	mm <sup>2</sup>
Stripping length / Blade size	mm/-
<b>Note</b>	

In accordance with IEC 60947-7-1

IEC	UL	CSA	EN 60079-7
250			
57			
10			
		4 kV / 3	
		A6 / V-0	

Rated connection	
0.5...10 / 0.5...10	
0.5...10 / 0.5...10	
18 / 1.0 x 5.5 mm	

Approval in progress

In accordance with IEC 60947-7-1

IEC	UL	CSA	EN 60079-7
250			
17			
10			
		4 kV / 3	
		A6 / V-0	

Rated connection	
0.5...10 / 0.5...10	
0.5...10 / 0.5...10	
18 / 1.0 x 5.5 mm	

Approval in progress

**Ordering data**

Version
beige Wemid / red and blue pushers
<b>Note</b>

Type	Qty.	Order No.
AAP22 10 LO-LO	20	<b>2428990000</b>

Type	Qty.	Order No.
AAP22 10 FE-LO	20	<b>2429000000</b>

**Accessories**

Pluggable cross-connection	
2-pole/ red	
10-pole / red	
2-pole / blue	
10-pole/ blue	
End plate / Partition plate	
End bracket	
dark beige	
dark beige	
Test plug	
Screwdriver	
Standard	
Identification systems	

Type	current	Qty.	Order No.
ZQV 4N/2 RD		60	<b>2460450000</b>
ZQV 4N/10 RD		20	<b>2460740000</b>
ZQV 4N/2 BL	32 A	60	<b>1528040000</b>
ZQV 4N/10 BL	32 A	20	<b>1528230000</b>
AEP AP22		20	<b>2429040000</b>
AEB 35 SC/1		50	<b>1991920000</b>
ZEW 35/2		20	<b>8630740000</b>
PS 2.0 MC		20	<b>0310000000</b>
SDIL 1,0x5,5x125		1	<b>9042130000</b>
WS 7.8/9.2 PLUS MC NE GR		360	<b>1208970000</b>

Type	current	Qty.	Order No.
ZQV 4N/2 RD		60	<b>2460450000</b>
ZQV 4N/10 RD		20	<b>2460740000</b>
ZQV 4N/2 BL	32 A	60	<b>1528040000</b>
ZQV 4N/10 BL	32 A	20	<b>1528230000</b>
AEP AP22		20	<b>2429040000</b>
AEB 35 SC/1		50	<b>1991920000</b>
ZEW 35/2		20	<b>8630740000</b>
PS 2.0 MC		20	<b>0310000000</b>
SDIL 1,0x5,5x125		1	<b>9042130000</b>
WS 7.8/9.2 PLUS MC NE GR		360	<b>1208970000</b>

For detailed information on other accessories and application in the online catalogue

All MultiMark variants (MM) = strip markers

All MultiMark variants (MM) = strip markers

Technical data

Machinery

Process

Energy

Transportation

Device Manufacturers

Infrastructure



**AAP - potential distribution terminal blocks**

**AAP22 4 LI-FS**

**4 mm<sup>2</sup>**

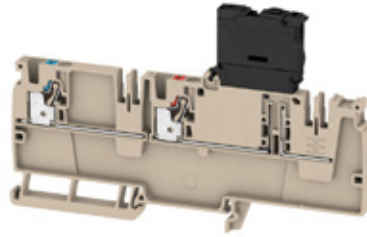

Width/Height/Depth	mm
max. current / max. cond. cross-section	A/mm <sup>2</sup>
Max. clamping range	mm <sup>2</sup>

6.1 x 129 x 82
<b>6.3 / 4</b>
<b>0.5...4</b>

In accordance with IEC 60947-7-1, In accordance with IEC 60947-7-3

**Technical data**

<b>Rated data</b>	
Rated voltage to adjoining terminal	V
Rated current	A
for wire cross-section	mm <sup>2</sup>
Rated impulse withstand voltage / Pollution severity	
UL 94 flammability rating	
Approvals	

IEC	UL	CSA	EN 60079-7
250			
6.3			
4			
		4 kV / 3	
		V-0	

**Clamped conductors (H05V/H07V)**

Solid / Stranded	mm <sup>2</sup>
Flexible / Flexible with ferrule	mm <sup>2</sup>
Stripping length	
Blade size	

<b>Rated connection</b>
0.5...4 / 0.5...4
0.5...4 / 0.5...4
12 mm
0.6 x 3.5 mm

**Note**

Approval in progress

**Ordering data**

<b>Version</b>	
	250 V AC/DC, without LED
	10-36 V AC/DC, with LED
	30-70 V AC/DC, with LED
	60-150 V AC/DC, with LED
	100-250 V AC/DC, with LED

Type	Qty.	Order No.
AAP22 4 LI-FS	50	<b>2429010000</b>
AAP22 4 LI-FS 10-36V	50	<b>2459010000</b>
AAP22 4 LI-FS 30-70V	50	<b>2460140000</b>
AAP22 4 LI-FS 60-150V	50	<b>2460130000</b>
AAP22 4 LI-FS 100-250V	50	<b>2460120000</b>

**Note**

**Accessories**

<b>Pluggable cross-connection</b>	
	2-pole / blue
	10-pole/ blue
	2-pole/ red
	10-pole / red

Type	current	Qty.	Order No.
ZQV 4N/2 BL	32 A	60	<b>1528040000</b>
ZQV 4N/10 BL	32 A	20	<b>1528230000</b>
ZQV 4N/2 RD		60	<b>2460450000</b>
ZQV 4N/10 RD		20	<b>2460740000</b>

**End plate / Partition plate**

AEP AP22	20	<b>2429040000</b>
----------	----	-------------------

**End bracket**

dark beige  
dark beige

AEB 35 SC/1	50	<b>1991920000</b>
ZEW 35	20	<b>9540000000</b>

**Screwdriver**

Standard

SDIL 0,6x3,5x100	1	<b>9042110000</b>
------------------	---	-------------------

**Identification systems**

WS 10/6 M PLUS MC NE WS	600	<b>2003780000</b>
DEK 5/6 MM WS	600	<b>2007120000</b>
WS 8/6 MM WS	600	<b>2007160000</b>
DEK 5/6 PLUS MC NE WS	1000	<b>1011320000</b>

**G-fuse cartridge, 5 x 20 mm (IEC 60127-2)**

0.25 A fast  
0.50 A fast  
1.00 A fast  
2.00 A fast

G 20/0.25A/F	10	<b>0430500000</b>
G 20/0.50A/F	10	<b>0430600000</b>
G 20/1.00A/F	10	<b>0430700000</b>
G 20/2.00A/F	10	<b>0430900000</b>

For detailed information on other accessories and application in the online catalogue

All MultiMark variants (MM) = strip markers

**maxGUARD – power-feed module**

Passive power-feed module

**AMG FIM-0**

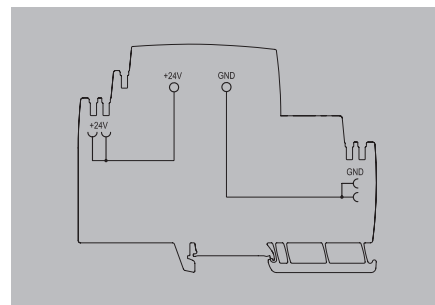

**Technical data**

Input	
Input fuse (internal)	No
DC input voltage range	18...30 V DC
Rated input voltage	24 V DC
Current consumption (idle)	
Current consumption (full load)	
max. admissible residual ripple at the input	100 mVpp
Surge protection	
General data	
Protection degree	IP20
Control inputs	No
Overvoltage category	III
Connection data	
Number of terminals	2 (+,-)
Wire cross-section, AWG/kcmil min/max	18..6
Wire cross-section, flexible min/max	0.75...16 mm <sup>2</sup>
Wire cross-section, rigid min/max	0.75...10 mm <sup>2</sup>
Screwdriver blade	1.2 x 6.5
Approvals	
Approvals	CE, TÜV (60950), cULus, UL 2367
Note	

**Ordering data**

Rated current	Type	Qty.	Order No.
	AMG FIM-0	1	<b>2081870000</b>
Note			

Technical data

Machinery

Process

Energy

Transportation

Device Manufacturers

Infrastructure

**maxGUARD – power-feed module**

Active power-feed module with reset and alarm function

**AMG FIM-C**

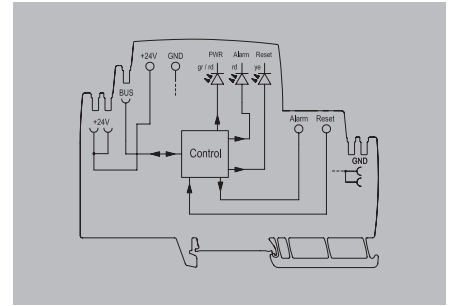

**Technical data**

Input	
Input fuse (internal)	No
DC input voltage range	18...30 V DC
Rated input voltage	24 V DC
Current consumption (idle)	20 mA
Current consumption (full load)	120 mA
max. admissible residual ripple at the input	100 mVpp
Surge protection	Suppressor diode
General data	
Protection degree	IP20
Control inputs	Reset
Overvoltage category	III
Signalling	
LED yellow	External reset is signalled, Alarm is signalled
LED green	Operating voltage OK
LED red	Alarm
Transistor output, positive-switching	Alarm
Connection data	
Number of terminals	2 (+,-)
Wire cross-section, AWG/kcmil min/max	18...6
Wire cross-section, flexible min/max	0.75...16 mm <sup>2</sup>
Wire cross-section, rigid min/max	0.75...10 mm <sup>2</sup>
Screwdriver blade	1.2 x 6.5
Approvals	
Approvals	CE, TÜV (60950), cULus, UL 2367
Note	

**Ordering data**

Rated current	
Note	

Type	Qty.	Order No.
AMG FIM-C	1	2081880000

Technical data

Machinery

Process

Energy

Transportation

Device Manufacturers

Infrastructure

**maxGUARD – load monitoring (fixed value)**

Electronic load monitoring with fixed current (without I > 90% function)

**AMG ELM - xF**

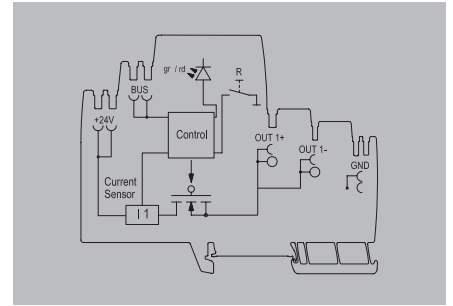

**Technical data**

Input	
Input fuse (internal)	Yes
DC input voltage range	18...30 V DC
Rated input voltage	24 V DC
Current consumption (idle) / Current consumption (full load)	25 mA / I <sub>load</sub> +30 mA
max. admissible residual ripple at the input	100 mVpp
Output	
Connection system	PUSH IN
Triggering characteristic	see characteristic curve
Switch-on delay	1 s
Capacitive load	2080420000: 10,000 µF; 2080480000: 10,000 µF; 2080490000: 10,000 µF; 2080500000: 15,000 µF
Surge protection	Suppressor diode
Function key	
LED initial state	LED green, in operation LED flashing red, load monitoring has triggered (disconnected) LED red (permanently lit)

Pressing the button	> 0.1 to 2 s (manual disconnect)	> 0.1 to 2 s (confirm and reset)	> 0.1 to 2 s (restart)
LED, subsequent state	Red LED switched off	Red LED switched off	LED green switched on

Pressing the button

LED, subsequent state  
Output, subsequent state

General data	
Relay to activate the output	No
Protection degree / Overvoltage category	IP20 / III
Signalling	
LED green	Operation (failure-free)
LED red	Load monitoring has disconnected, Load monitoring has triggered (flashing), Internal error (rapid flashing)
Connection data	
Number of terminals	2 (+ / -)
Wire cross-section, AWG/kcmil min/max	26...12
Wire cross-section, flexible min/max	0.14...2.5 mm <sup>2</sup>
Wire cross-section, rigid min/max	0.14...2.5 mm <sup>2</sup>
Screwdriver blade	0.6 x 3.5
Approvals	
Approvals	CE, TÜV (60950), cULus, UL 2367
Note	

Type	Qty.	Order No.
AMG ELM-1F	1	2080420000
AMG ELM-2F	1	2080480000
AMG ELM-4F	1	2080490000
AMG ELM-6F	1	2080500000

**Ordering data**

Rated current	
1.00 A	
2.00 A	
4.00 A	
6.00 A	
Note	

Type	Qty.	Order No.
AMG DIS	10	2123050000
AMG MD	10	2122930000
AMG OD	10	2122910000
AMG PD	10	2122920000

**Accessories**

Note	
------	--

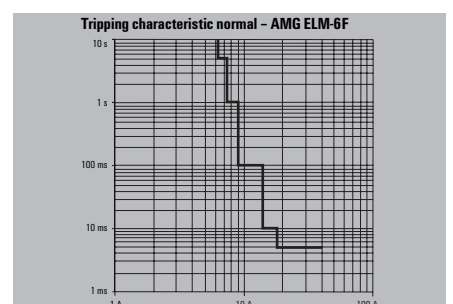
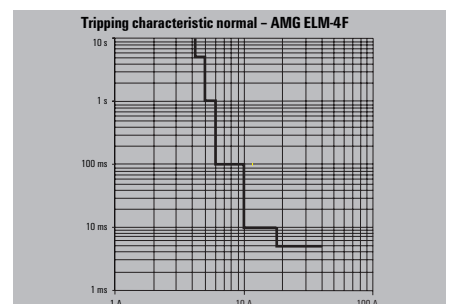
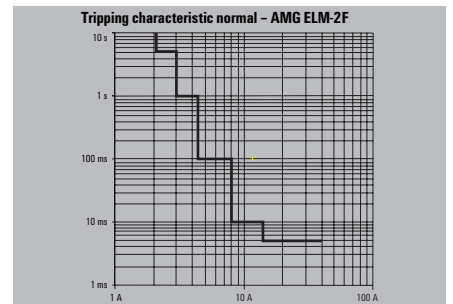
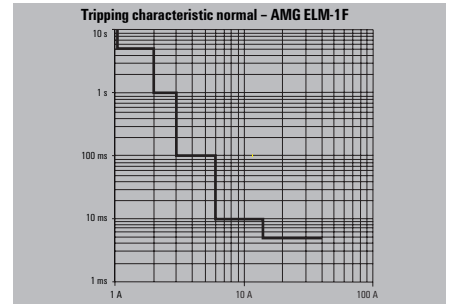

Technical data

Machinery

Process

Energy

Transportation

Device Manufacturers

Infrastructure

**maxGUARD – load monitoring (fixed value)**

Electronic load monitoring with fixed rated current (without I > 90 % pre warning)

**Technical data**

Input	
Input fuse (internal)	Yes
DC input voltage range	18...30 V DC
Rated input voltage	24 V DC
Current consumption (idle)	25 mA
Current consumption (full load)	I <sub>OUT</sub> +30 mA
max. admissible residual ripple at the input	100 mVpp
Surge protection	Suppressor diode
Output	
Connection system	PUSH IN
Triggering characteristic	see characteristic curve
Switch-on delay	1 s
Capacitive load	2080600000: 15,000 µF; 2080650000: 20,000 µF
Function key	
LED initial state	LED green, in operation
Pressing the button	> 0.1 to 2 s (manual disconnect)
LED, subsequent state	LED flashing red, load monitoring has triggered (disconnected)
Output, subsequent state	LED red (permanently lit)
General data	
Relay to activate the output	No
Protection degree	IP20
Oversvoltage category	III
Signalling	
LED green	Operation (failure-free)
LED red	Load monitoring has disconnected, Load monitoring has triggered (flashing), Internal error (rapid flashing)
Connection data	
Number of terminals	4 (++ / -)
Wire cross-section, AWG/kcmil min/max	26...12
Wire cross-section, flexible min/max	0.14...2.5 mm <sup>2</sup>
Wire cross-section, rigid min/max	0.14...2.5 mm <sup>2</sup>
Screwdriver blade	0.6 x 3.5
Approvals	
Approvals	CE, TÜV (60950), cULus, UL 2367
Note	

**Ordering data**

Rated current	8.00 A
	10.00 A
Note	

**Accessories**

Type	Qty.	Order No.
AMG DIS	10	2123050000
AMG MD	10	2122930000
AMG OD	10	2122910000
AMG PD	10	2122920000
Note		

**AMG ELM - xF**



Type	Qty.	Order No.
AMG ELM-8F	1	2080600000
AMG ELM-10F	1	2080650000

Type	Qty.	Order No.
AMG DIS	10	2123050000
AMG MD	10	2122930000
AMG OD	10	2122910000
AMG PD	10	2122920000
Note		

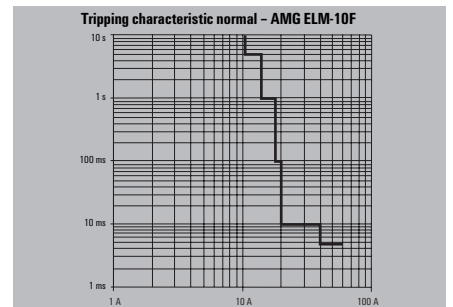
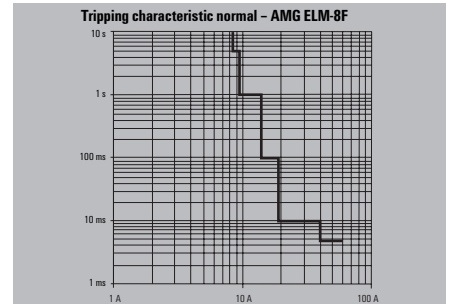
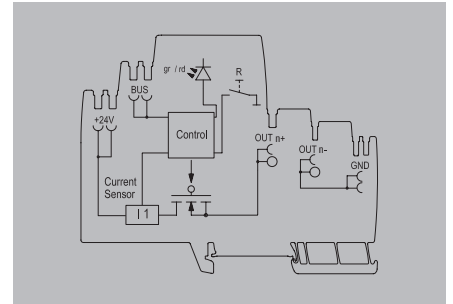

Technical data

Machinery



Process



Energy



Transportation



Device Manufacturers



Infrastructure



**maxGUARD – load monitoring (fixed value), Class 2**

Electronic load monitoring with fixed rated current (without I > 90 % pre warning)  
 • Class 2 Approval

**AMG ELM - xF CL2**

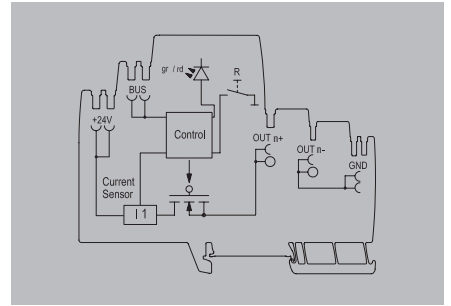

**Technical data**

Input	
Input fuse (internal)	Yes
DC input voltage range	18...30 V DC
Rated input voltage	24 V DC
Current consumption (idle)	25 mA
Current consumption (full load)	I <sub>OUT</sub> +30 mA
max. admissible residual ripple at the input	100 mVpp
Surge protection	Suppressor diode
Output	
Connection system	PUSH IN
Triggering characteristic	see characteristic curve
Switch-on delay	1 s
Capacitive load	4.700 µF

Yes
18...30 V DC
24 V DC
25 mA
I <sub>OUT</sub> +30 mA
100 mVpp
Suppressor diode
PUSH IN
see characteristic curve
1 s
4.700 µF

**Function key**

LED initial state	LED green, in operation	LED flashing red, load monitoring has triggered (disconnected)	LED red (permanently lit)
Pressing the button	> 0.1 to 2 s (manual disconnect)	> 0.1 to 2 s (confirm and reset)	> 0.1 to 2 s (restart)
LED, subsequent state	Red LED switched off	Red LED switched off	LED green switched on

LED green, in operation	LED flashing red, load monitoring has triggered (disconnected)	LED red (permanently lit)
> 0.1 to 2 s (manual disconnect)	> 0.1 to 2 s (confirm and reset)	> 0.1 to 2 s (restart)
Red LED switched off	Red LED switched off	LED green switched on

**General data**

Relay to activate the output	No
Protection degree	IP20
Overvoltage category	III

No
IP20
III

**Signalling**

LED green	Operation (failure-free)
LED red	Load monitoring has disconnected, Load monitoring has triggered (flashing), Internal error (rapid flashing)

Operation (failure-free)
Load monitoring has disconnected, Load monitoring has triggered (flashing), Internal error (rapid flashing)

**Connection data**

Number of terminals	2 (+ / -)
Wire cross-section, AWG/kcmil min/max	26...12
Wire cross-section, flexible min/max	0.14...2.5 mm <sup>2</sup>
Wire cross-section, rigid min/max	0.14...2.5 mm <sup>2</sup>
Screwdriver blade	0.6 x 3.5

2 (+ / -)
26...12
0.14...2.5 mm <sup>2</sup>
0.14...2.5 mm <sup>2</sup>
0.6 x 3.5

**Approvals**

Approvals	CE, TÜV (60950), cULus, UL 2367, class 2 (UL 1310)
-----------	--

CE, TÜV (60950), cULus, UL 2367, class 2 (UL 1310)
--

**Note**

--	--

Type	Qty.	Order No.
AMG ELM-1F CL2	1	2491270000
AMG ELM-2F CL2	1	2491280000
AMG ELM-4F CL2	1	2491290000

**Ordering data**

	1.00 A
	2.00 A
	4.00 A

Type	Qty.	Order No.
AMG ELM-1F CL2	1	2491270000
AMG ELM-2F CL2	1	2491280000
AMG ELM-4F CL2	1	2491290000

**Note**

--	--

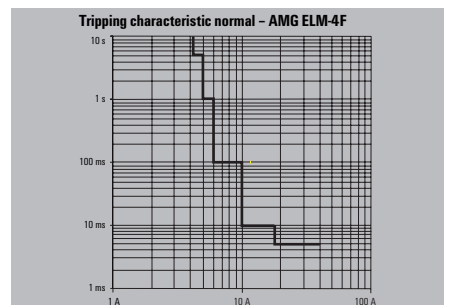
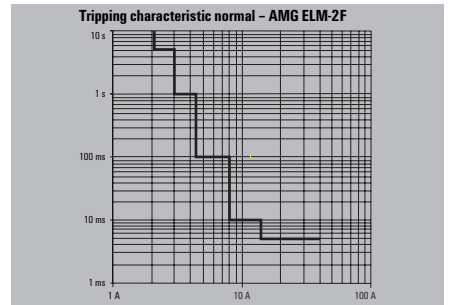
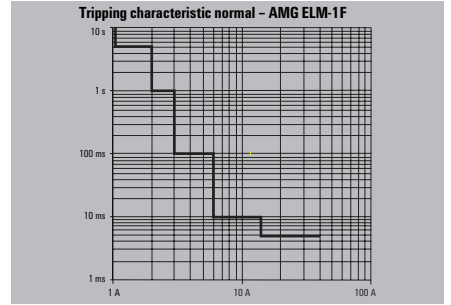

Technical data

Machinery

Process

Energy

Transportation

Device Manufacturers

Infrastructure

**maxGUARD – load monitoring adjustable**

Electronic load monitoring with adjustable triggering current and triggering characteristic

**Technical data**

Input	
Input fuse (internal)	Yes
DC input voltage range	18...30 V DC
Rated input voltage	24 V DC
Current consumption (idle)	25 mA
Current consumption (full load)	I <sub>OUT</sub> +30 mA
max. admissible residual ripple at the input	100 mVpp
Output	
Connection system	PUSH IN
Triggering characteristic	see characteristic curve
Backup modes	1- 6 A
Switch-on delay	1 s
Capacitive load	15,000 µF
adjustable rated current	Yes
Surge protection	Suppressor diode
Function key	
LED initial state	LED green, in operation
	LED flashing red, load monitoring has triggered (disconnected)
	LED red (permanently lit)
Pressing the button	> 0.1 to 2 s (manual disconnect)
	> 0.1 to 2 s (confirm and reset)
	> 0.1 to 2 s (restart)
LED, subsequent state	Red LED switched off
Output, subsequent state	Red LED switched off
LED green	LED green switched on
General data	
Relay to activate the output	No
Protection degree	IP20
Overvoltage category	III
Signalling	
LED green	Operation (failure-free), Early warning: I <sub>Out</sub> > 90% I <sub>Rated</sub> (flashing)
LED red	Load monitoring has disconnected, Load monitoring has triggered (flashing), Internal error (rapid flashing)
Connection data	
Number of terminals	2 (+ / -)
Wire cross-section, AWG/kcmil min/max	26...12
Wire cross-section, flexible min/max	0.14...2.5 mm <sup>2</sup>
Wire cross-section, rigid min/max	0.14...2.5 mm <sup>2</sup>
Screwdriver blade	0.6 x 3.5
Approvals	
Approvals	CE, TÜV (60950), cULus, UL 2367
Note	

**Ordering data**

Rated current	6.00 A
Note	

**Accessories**

Type	Qty.	Order No.
AMG DIS	10	2123050000
AMG MD	10	2122930000
AMG OD	10	2122910000
AMG PD	10	2122920000
Note		

**AMG ELM-6**

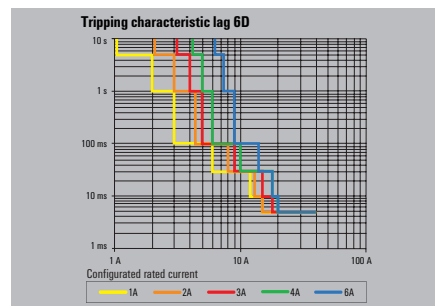
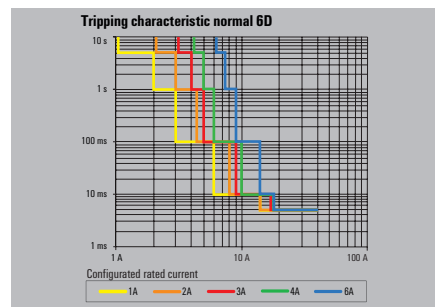
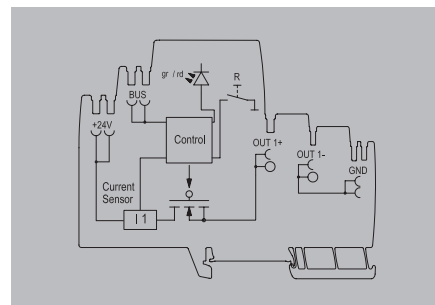

Type	Qty.	Order No.
AMG ELM-6	1	2080360000

Type	Qty.	Order No.
AMG DIS	10	2123050000
AMG MD	10	2122930000
AMG OD	10	2122910000
AMG PD	10	2122920000
Note		

Technical data

Machinery

Process

Energy

Transportation

Device Manufacturers

Infrastructure

**maxGUARD – load monitoring adjustable**

Electronic load monitoring with adjustable trigger current and characteristic (with I > 90 % pre warning)

**AMG ELM-12**

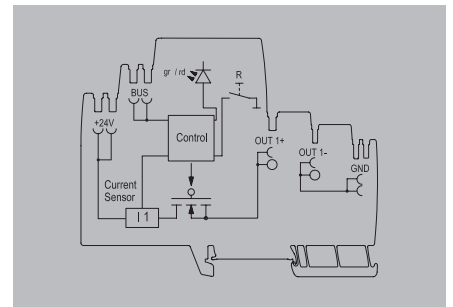

**Technical data**

Input	
Input fuse (internal)	Yes
DC input voltage range	18...30 V DC
Rated input voltage	24 V DC
Current consumption (idle)	25 mA
Current consumption (full load)	I <sub>OUT</sub> +30 mA
max. admissible residual ripple at the input	100 mVpp
Output	
Connection system	PUSH IN
Triggering characteristic	see characteristic curve
Backup modes	4-12 A
Switch-on delay	1 s
adjustable rated current	Yes
Capacitive load	20,000 µF
Surge protection	Suppressor diode
Function key	
LED initial state	LED green, in operation

LED flashing red, load monitoring has triggered (disconnected)	LED red (permanently lit)	
> 0.1 to 2 s (manual disconnect)	> 0.1 to 2 s (confirm and reset)	> 0.1 to 2 s (restart)
Red LED switched off	Red LED switched off	LED green switched on

Pressing the button

LED, subsequent state	LED green
Output, subsequent state	LED green
General data	
Relay to activate the output	No
Protection degree	IP20
Oversvoltage category	III
Signalling	
LED green	Operation (failure-free), Early warning: I <sub>Out</sub> > 90% I <sub>Rated</sub> (flashing)
LED red	Load monitoring has disconnected, Load monitoring has triggered (flashing), Internal error (rapid flashing)

Connection data	
Number of terminals	4 (++) / -)
Wire cross-section, AWG/kcmil min/max	26...12
Wire cross-section, flexible min/max	0.14...2.5 mm <sup>2</sup>
Wire cross-section, rigid min/max	0.14...2.5 mm <sup>2</sup>
Screwdriver blade	0.6 x 3.5
Approvals	
Approvals	CE, TÜV (60950), cULus, UL 2367
Note	

**Ordering data**

Rated current	12.00 A
Note	

Type	Qty.	Order No.
AMG ELM-12	1	2080410000

**Accessories**

Type	Qty.	Order No.
AMG DIS	10	2123050000
AMG MD	10	2122930000
AMG OD	10	2122910000
AMG PD	10	2122920000
Note		

Type	Qty.	Order No.
AMG DIS	10	2123050000
AMG MD	10	2122930000
AMG OD	10	2122910000
AMG PD	10	2122920000
Note		

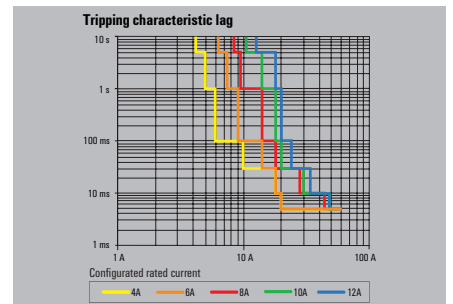
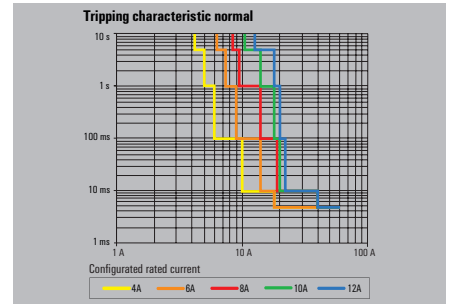

Technical data

Machinery

Process

Energy

Transportation

Device Manufacturers

Infrastructure



**maxGUARD – load monitoring with relay**

Electronic load monitoring with 2-pole output relay for all-pole load disconnection; triggering current and triggering characteristic adjustable.

**Technical data**

Input	
Input fuse (internal)	Yes
DC input voltage range	18...30 V DC
Rated input voltage	24 V DC
Current consumption (idle)	40 mA
max. admissible residual ripple at the input	100 mVpp

Output	
Connection system	PUSH IN
Triggering characteristic	see characteristic curve
Backup modes	2082470000: 4- 10 A 2082440000: 1- 6 A

Switch-on delay  
adjustable rated current  
Capacitive load

Surge protection

Function key	
LED initial state	LED green, in operation

Pressing the button

LED, subsequent state  
Output, subsequent state

General data	
Relay to activate the output	Yes
Protection degree / Surge protection	IP20 / Suppressor diode
Conformal coating	Yes

Signalling	
LED green	LED flashing red, load monitoring has triggered (disconnected)
LED red	LED red (permanently lit)

Connection data	
Number of terminals	6 (3x + / 3x -)
Wire cross-section, AWG/kcmil min/max	26...12
Wire cross-section, flexible min/max	0.14...2.5 mm <sup>2</sup>
Wire cross-section, rigid min/max	0.14...2.5 mm <sup>2</sup>
Screwdriver blade	0.6 x 3.5

Approvals	
Approvals	CE, TÜV (60950), cULus, UL 2367, GL-DNV, BV, ABS, LR, RINA, ISA 12.12.01, ATEX, IECEx

Note	
------	--

**Ordering data**

Rated current	
	6.00 A
	10.00 A

Note	
------	--

**Accessories**

Type	
AMG DIS	10
AMG MD	10
AMG OD	10
AMG PD	10

Note	
------	--

**AMG ELM – adjustable with output relay**



Input	
Input fuse (internal)	Yes
DC input voltage range	18...30 V DC
Rated input voltage	24 V DC
Current consumption (idle)	40 mA
max. admissible residual ripple at the input	100 mVpp

Output	
Connection system	PUSH IN
Triggering characteristic	see characteristic curve
Backup modes	2082470000: 4- 10 A 2082440000: 1- 6 A

1 s

Yes  
20,000 µF  
15,000 µF

Suppressor diode

LED green, in operation	LED flashing red, load monitoring has triggered (disconnected)	LED red (permanently lit)
-------------------------	--	---------------------------

> 0.1 to 2 s (manual disconnect)	> 0.1 to 2 s (confirm and reset)	> 0.1 to 2 s (restart)
----------------------------------	----------------------------------	------------------------

Red LED switched off	Red LED switched off	LED green switched on
----------------------	----------------------	-----------------------

General data	
Relay to activate the output	Yes
Protection degree / Surge protection	IP20 / Suppressor diode
Conformal coating	Yes

Operation (failure-free), Early warning: I Out > 90% I Rated (flashing)  
Load monitoring has disconnected, Load monitoring has triggered (flashing), Internal error (rapid flashing)

Connection data	
Number of terminals	6 (3x + / 3x -)
Wire cross-section, AWG/kcmil min/max	26...12
Wire cross-section, flexible min/max	0.14...2.5 mm <sup>2</sup>
Wire cross-section, rigid min/max	0.14...2.5 mm <sup>2</sup>
Screwdriver blade	0.6 x 3.5

Approvals	
Approvals	CE, TÜV (60950), cULus, UL 2367, GL-DNV, BV, ABS, LR, RINA, ISA 12.12.01, ATEX, IECEx

Note	
------	--

Type	Qty.	Order No.
AMG ELM-6D CO	1	2082440000
AMG ELM-10D CO	1	2082470000

Note	
------	--

Type	Qty.	Order No.
AMG DIS	10	2123050000
AMG MD	10	2122930000
AMG OD	10	2122910000
AMG PD	10	2122920000

Note	
------	--

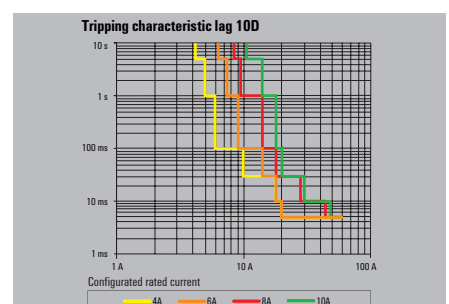
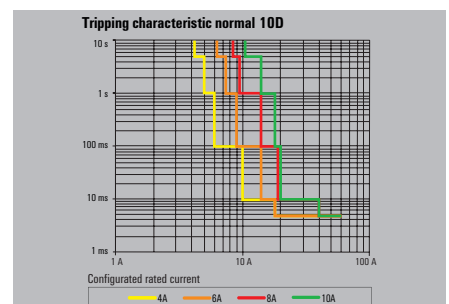
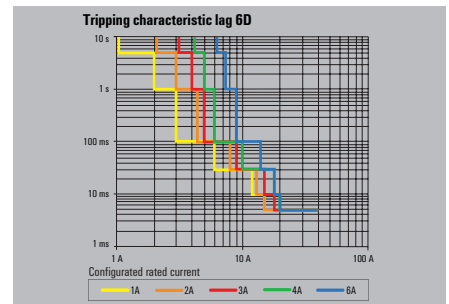
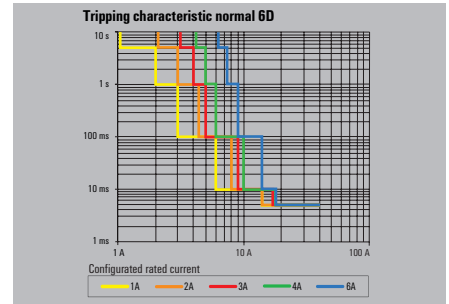
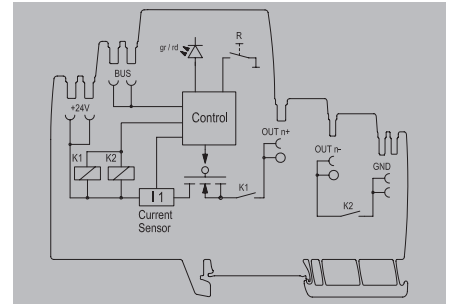

Technical data

Machinery

Process

Energy

Transportation

Device Manufacturers

Infrastructure

**maxGUARD – load monitoring, 4 channels**

4-channel electronic load monitoring with fixed triggering current.

**AMG ELM - Qxxxx**

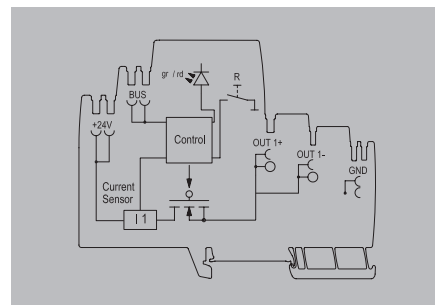

**Technical data**

Input	
Input fuse (internal)	Yes
DC input voltage range	18...30 V DC
Rated input voltage	24 V DC
Current consumption (idle) / Current consumption (full load)	35 mA / 4x I <sub>OUT</sub> +45 mA
max. admissible residual ripple at the input	100 mVpp
Output	
Connection system	PUSH IN
Triggering characteristic	see characteristic curve
Switch-on delay	1 s
adjustable rated current	No
Capacitive load	10,000 µF
Surge protection	Suppressor diode
Rated current per channel	2080750000: 2 A; 2 A; 2 A; 2 A 2081650000: 2 A; 2 A; 4 A; 4 A 2081820000: 2 A; 2 A; 6 A; 6 A 2080880000: 4 A; 4 A; 4 A; 4 A 2080920000: 6 A; 6 A; 6 A; 6 A

Number of channels	4
Function key	
LED initial state	LED green, in operation
Pressing the button	> 0.1 to 2 s (manual disconnect)

LED, subsequent state	Red LED switched off
Output, subsequent state	Red LED switched off

General data	
Relay to activate the output	No
Protection degree / Overvoltage category	IP20 / III

Signalling	
LED green	LED green
LED red	LED red (permanently lit)

Connection data	
Number of terminals	8 (4x ++)
Wire cross-section, AWG/kcmil min/max	26...12
Wire cross-section, flexible min/max	0.14...2.5 mm <sup>2</sup>
Wire cross-section, rigid min/max	0.14...2.5 mm <sup>2</sup>
Screwdriver blade	0.6 x 3.5

Approvals	
Approvals	CE, TÜV (60950), cULus, UL 2367

Note	
------	--

**Ordering data**

Rated current	
Note	

**Accessories**

Note	
------	--

Suppressor diode		
2080750000:	2 A; 2 A; 2 A; 2 A	
2081650000:	2 A; 2 A; 4 A; 4 A	
2081820000:	2 A; 2 A; 6 A; 6 A	
2080880000:	4 A; 4 A; 4 A; 4 A	
2080920000:	6 A; 6 A; 6 A; 6 A	

LED green, in operation	LED flashing red, load monitoring has triggered (disconnected)	LED red (permanently lit)
> 0.1 to 2 s (manual disconnect)	> 0.1 to 2 s (confirm and reset)	> 0.1 to 2 s (restart)
Red LED switched off	Red LED switched off	LED green switched on

Operation (failure-free)		
Load monitoring has disconnected, Load monitoring has triggered (flashing), Internal error (rapid flashing)		

Type	Qty.	Order No.
AMG ELM-Q2222	1	2080750000
AMG ELM-Q2244	1	2081650000
AMG ELM-Q2266	1	2081820000
AMG ELM-Q4444	1	2080880000
AMG ELM-Q6666	1	2080920000

Type	Qty.	Order No.
AMG XMD	10	2122940000

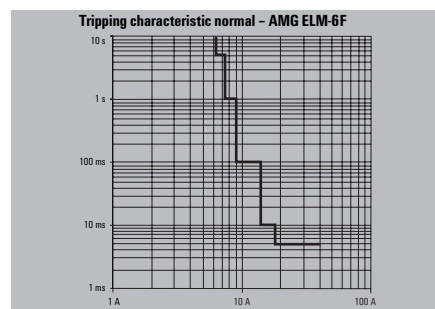
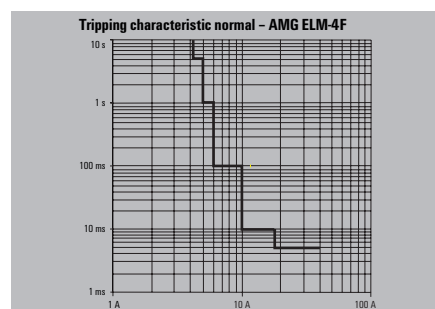
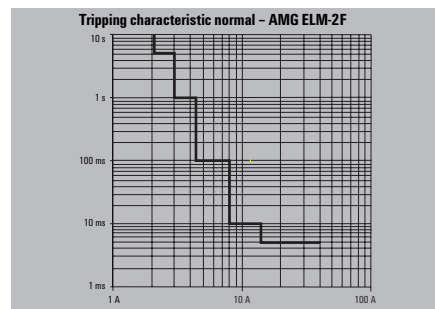

**maxGUARD – Alarm module**

Alarm module with potential-free contacts for the “Alarm” and “I>90%” signals.

**Technical data**

<b>Input</b>
Input fuse (internal)
DC input voltage range
Rated input voltage
Current consumption (idle)
Current consumption (full load)
max. admissible residual ripple at the input
Surge protection
<b>General data</b>
Protection degree
Overvoltage category
<b>Signalling</b>
LED yellow
LED red
Floating contact
Status relay (max. load)
<b>Connection data</b>
Number of terminals
Wire cross-section, AWG/kcmil min/max
Wire cross-section, flexible min/max
Wire cross-section, rigid min/max
Screwdriver blade
<b>Approvals</b>
Approvals
<b>Note</b>

**Ordering data**

<b>Rated current</b>
<b>Note</b>

**Accessories**

<b>Pluggable cross-connection</b>	
	50-pole
	50-pole / red
	50-pole / blue
	2-pole
	2-pole/ red
	2-pole / blue
<b>Note</b>	

**AMG AM**

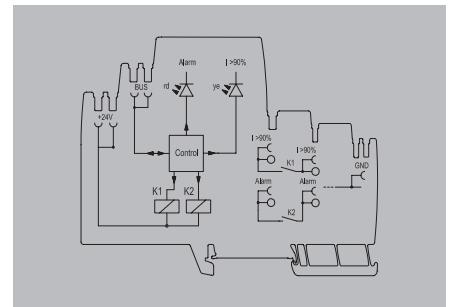

No
18...30 V DC
24 V DC
25 mA
30 mA
100 mVpp
Suppressor diode
IP20
III
Current > 90% Inom (flashing)
Alarm
Yes
Alarm (24 V / 0.1 A), I > 90% (24 V / 0.1 A)
4 (2 x NO)
26...12
0.14...2.5 mm <sup>2</sup>
0.14...2.5 mm <sup>2</sup>
0.6 x 3.5
CE, TÜV (60950), cULus, UL 2367

Type	Qty.	Order No.
AMG AM	1	2081890000

Type	Qty.	Order No.
ZQV 4N/50	5	1528130000
ZQV 4N/50 RD	5	2460730000
ZQV 4N/50 BL	5	1528240000
ZQV 4N/2	60	1527930000
ZQV 4N/2 RD	60	2460450000
ZQV 4N/2 BL	60	1528040000

Technical data

Machinery



Process



Energy



Transportation



Device Manufacturers



Infrastructure



**maxGUARD – control module**

Control module with extended control function: Alarm, Reset, >90%, ON/OFF

**AMG CM**

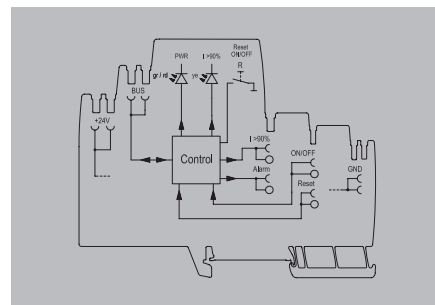

**Technical data**

Input	
DC input voltage range	18...30 V DC
Rated input voltage	24 V DC
Current consumption (idle)	25 mA
Current consumption (full load)	225 mA
max. admissible residual ripple at the input	100 mVpp
Output	
Connection system	PUSH IN
Surge protection	Suppressor diode
General data	
Relay to activate the output	No
Protection degree	IP20
Control inputs	ON/ OFF, Reset
Overvoltage category	III
Signalling	
LED green	Operation (failure-free), Early warning: I Out > 90% I Rated (flashing)
LED red	Load monitoring has disconnected, Load monitoring has triggered (flashing), Internal error (rapid flashing)
Transistor output, positive-switching	Pre-warning, Alarm
Connection data	
Number of terminals	2 (Reset / ON)
Wire cross-section, AWG/kcmil min/max	26...12
Wire cross-section, flexible min/max	0.14...2.5 mm <sup>2</sup>
Wire cross-section, rigid min/max	0.14...2.5 mm <sup>2</sup>
Screwdriver blade	0.6 x 3.5
Approvals	
Approvals	CE, TÜV (60950), cULus, UL 2367
Note	

Technical data		
DC input voltage range	18...30 V DC	
Rated input voltage	24 V DC	
Current consumption (idle)	25 mA	
Current consumption (full load)	225 mA	
max. admissible residual ripple at the input	100 mVpp	
Output		
Connection system	PUSH IN	
Surge protection	Suppressor diode	
General data		
Relay to activate the output	No	
Protection degree	IP20	
Control inputs	ON/ OFF, Reset	
Overvoltage category	III	
Signalling		
LED green	Operation (failure-free), Early warning: I Out > 90% I Rated (flashing)	
LED red	Load monitoring has disconnected, Load monitoring has triggered (flashing), Internal error (rapid flashing)	
Transistor output, positive-switching	Pre-warning, Alarm	
Connection data		
Number of terminals	2 (Reset / ON)	
Wire cross-section, AWG/kcmil min/max	26...12	
Wire cross-section, flexible min/max	0.14...2.5 mm <sup>2</sup>	
Wire cross-section, rigid min/max	0.14...2.5 mm <sup>2</sup>	
Screwdriver blade	0.6 x 3.5	
Approvals		
Approvals	CE, TÜV (60950), cULus, UL 2367	
Note		

**Ordering data**

Rated current	
Note	

Type	Qty.	Order No.
AMG CM	1	2081900000

**Accessories**

Pluggable cross-connection	
50-pole	ZQV 4N/50
50-pole / red	ZQV 4N/50 RD
50-pole / blue	ZQV 4N/50 BL
2-pole	ZQV 4N/2
2-pole/ red	ZQV 4N/2 RD
2-pole / blue	ZQV 4N/2 BL
Note	

Type	Qty.	Order No.
ZQV 4N/50	5	1528130000
ZQV 4N/50 RD	5	2460730000
ZQV 4N/50 BL	5	1528240000
ZQV 4N/2	60	1527930000
ZQV 4N/2 RD	60	2460450000
ZQV 4N/2 BL	60	1528040000

Technical data

Machinery

Process

Energy

Transportation

Device Manufacturers

Infrastructure

**maxGUARD – Potential distributor**

Potential distribution in combination with the electronic load monitoring.

**AMG**

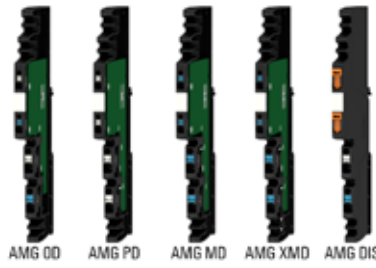

**Technical data**

**General data**

Protection degree  
Total current load per potential

Current load per contact point

**Connection data**

Connection system  
Number of terminals  
Wire cross-section, AWG/kcmil min/max  
Wire cross-section, flexible min/max  
Wire cross-section, rigid min/max  
Screwdriver blade

**Approvals**

Approvals

**Note**

**Ordering data**

**Note**

**Accessories**

**Pluggable cross-connection**

50-pole  
50-pole / red  
50-pole / blue  
2-pole  
2-pole/ red  
2-pole / blue

**Note**

**IP20**

2122910000: 12 A;  
2122920000: 12 A;  
2122930000: 12 A;  
2122940000: 24 A;  
2123050000: 12 A

12 A

**PUSH IN**

2 x 1.5 mm<sup>2</sup>, 2 x 2.5 mm<sup>2</sup>  
26...12  
0.14...2.5 mm<sup>2</sup>  
0.14...2.5 mm<sup>2</sup>  
0.6 x 3.5

CE, TÜV (60950), cULus, UL 2367

Type	Qty.	Order No.
AMG OD	10	2122910000
AMG PD	10	2122920000
AMG MD	10	2122930000
AMG XMD	10	2122940000
AMG DIS	10	2123050000

Type	Qty.	Order No.
ZQV 4N/50	5	1528130000
ZQV 4N/50 RD	5	2460730000
ZQV 4N/50 BL	5	1528240000
ZQV 4N/2	60	1527930000
ZQV 4N/2 RD	60	2460450000
ZQV 4N/2 BL	60	1528040000

AMG OD

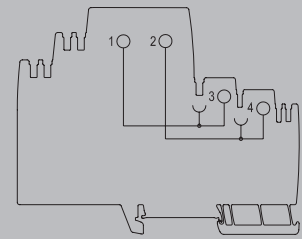

AMG PD

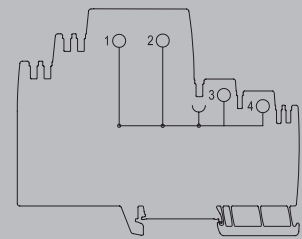

AMG MD

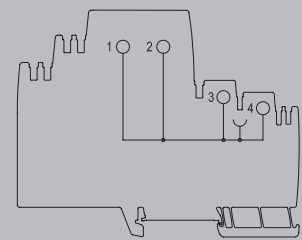

AMG XMD

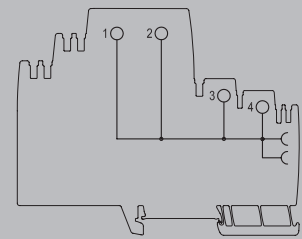

AMG DIS

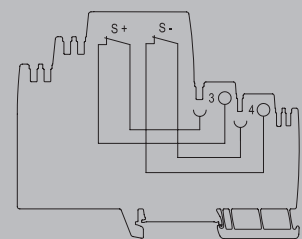

Technical data

Machinery



Process



Energy



Transportation



Device Manufacturers



Infrastructure



**maxGUARD – power-feed module**

Passive power-feed module

**AMG FIM-0 Ex**

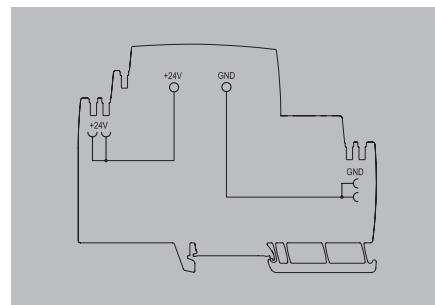

**Technical data**

Input	
Input fuse (internal)	No
DC input voltage range	18...30 V DC
Rated input voltage	24 V DC
Current consumption (idle)	
Current consumption (full load)	
max. admissible residual ripple at the input	100 mVpp
Surge protection	
General data	
Protection degree	IP20
Control inputs	No
Overvoltage category	III
Connection data	
Number of terminals	2 (+,-)
Wire cross-section, AWG/kcmil min/max	18..6
Wire cross-section, flexible min/max	0.75...16 mm <sup>2</sup>
Wire cross-section, rigid min/max	0.75...10 mm <sup>2</sup>
Screwdriver blade	1.2 x 6.5
Approvals	
Approvals	CE, TÜV (60950), cULus, UL 2367, GL-DNV, BV, ABS, LR, RINA, ISA 12.12.01, ATEX, IECEX
Note	

**Ordering data**

Rated current	Type	Qty.	Order No.
	AMG FIM-0 EX	1	2082530000
Note			

Technical data

Machinery

Process

Energy

Transportation

Device Manufacturers

Infrastructure

**maxGUARD – power-feed module**

Active power-feed module with reset and alarm function

**AMG FIM-C Ex**

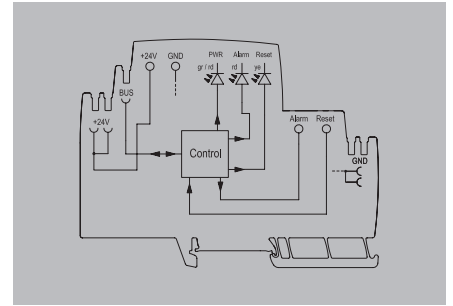

**Technical data**

<b>Input</b>
Input fuse (internal)
DC input voltage range
Rated input voltage
Current consumption (idle)
Current consumption (full load)
max. admissible residual ripple at the input
Surge protection
<b>General data</b>
Protection degree
Control inputs
Overvoltage category
<b>Signalling</b>
LED yellow
LED green
LED red
Transistor output, positive-switching
<b>Connection data</b>
Number of terminals
Wire cross-section, AWG/kcmil min/max
Wire cross-section, flexible min/max
Wire cross-section, rigid min/max
Screwdriver blade
<b>Approvals</b>
Approvals
<b>Note</b>
<b>Ordering data</b>
<b>Rated current</b>
<b>Note</b>

No		
18...30 V DC		
24 V DC		
20 mA		
120 mA		
100 mVpp		
Suppressor diode		
IP20		
Reset		
III		
External reset is signalled, Alarm is signalled		
Operating voltage OK		
Alarm		
Alarm		
2 (+,-)		
18...6		
0.75...16 mm <sup>2</sup>		
0.75...10 mm <sup>2</sup>		
1.2 x 6.5		
CE, TÜV (60950), cULus, UL 2367, GL-DNV, BV, ABS, LR, RINA, ISA 12.12.01, ATEX, IECEx		
<b>Type</b>	<b>Qty.</b>	<b>Order No.</b>
AMG FIM-C EX	1	2082540000

Technical data

Machinery

Process

Energy

Transportation

Device Manufacturers

Infrastructure

**maxGUARD – load monitoring (fixed value)**

Electronic load monitoring with fixed current (without I > 90% function)

**AMG ELM - xF Ex**

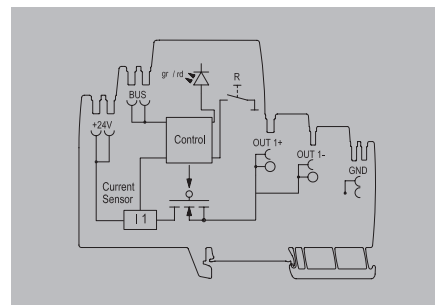

**Technical data**

Input	
Input fuse (internal)	Yes
DC input voltage range	18...30 V DC
Rated input voltage	24 V DC
Current consumption (idle) / Current consumption (full load)	25 mA / I <sub>OUT</sub> +30 mA
max. admissible residual ripple at the input	100 mVpp

Output	
Connection system	PUSH IN
Triggering characteristic	see characteristic curve
Switch-on delay	1 s
Capacitive load	2082040000: 10,000 µF; 2082050000: 10,000 µF; 2082060000: 10,000 µF; 2082310000: 15,000 µF

Surge protection

Function key	
LED initial state	LED green, in operation

Pressing the button

LED, subsequent state  
Output, subsequent state

General data	
Relay to activate the output	No
Protection degree / Overvoltage category	IP20 / III

Signalling	
LED green	LED green
LED red	LED red (permanently lit)

Connection data	
Number of terminals	2 (+ / -)
Wire cross-section, AWG/kcmil min/max	26...12
Wire cross-section, flexible min/max	0.14...2.5 mm <sup>2</sup>
Wire cross-section, rigid min/max	0.14...2.5 mm <sup>2</sup>
Screwdriver blade	0.6 x 3.5

Approvals	
Approvals	CE, TÜV (60950), cULus, UL 2367, GL-DNV, BV, ABS, LR, RINA, ISA 12.12.01, ATEX, IECEx

Note	
------	--

**Ordering data**

Rated current	
1.00 A	
2.00 A	
4.00 A	
6.00 A	

Note	
------	--

**Accessories**

Note	
------	--

Suppressor diode		
LED green, in operation	LED flashing red, load monitoring has triggered (disconnected)	LED red (permanently lit)
> 0.1 to 2 s (manual disconnect)	> 0.1 to 2 s (confirm and reset)	> 0.1 to 2 s (restart)
Red LED switched off	Red LED switched off	LED green switched on

Operation (failure-free)		
Load monitoring has disconnected, Load monitoring has triggered (flashing), Internal error (rapid flashing)		

Note		
------	--	--

Note		
------	--	--

Note		
------	--	--

Note		
------	--	--

Note		
------	--	--

Note		
------	--	--

Note		
------	--	--

Type	Qty.	Order No.
AMG ELM-1F EX	1	2082040000
AMG ELM-2F EX	1	2082050000
AMG ELM-4F EX	1	2082060000
AMG ELM-6F EX	1	2082310000

Type	Qty.	Order No.
AMG DIS	10	2123050000
AMG MD	10	2122930000
AMG OD	10	2122910000
AMG PD	10	2122920000

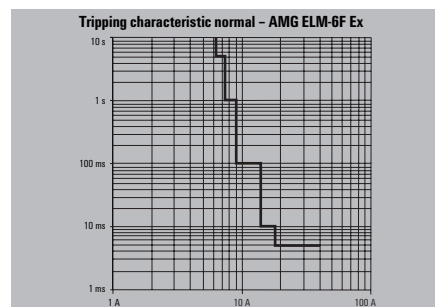
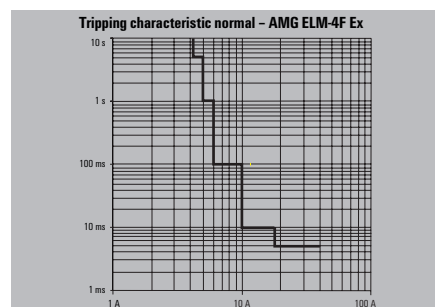
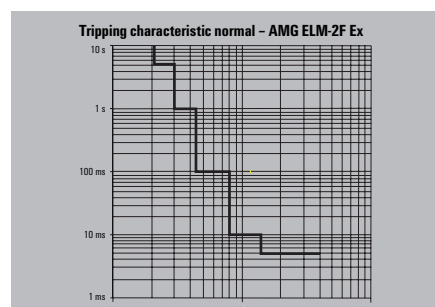
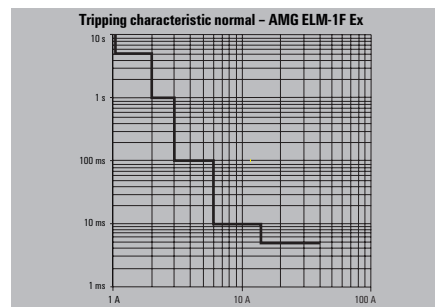

Technical data

Machinery

Process

Energy

Transportation

Device Manufacturers

Infrastructure



**maxGUARD – load monitoring (fixed value)**

Electronic load monitoring with fixed rated current (without I > 90 % pre warning)

**Technical data**

**Input**

- Input fuse (internal)
- DC input voltage range
- Rated input voltage
- Current consumption (idle)
- Current consumption (full load)
- max. admissible residual ripple at the input
- Surge protection

**Output**

- Connection system
- Triggering characteristic
- Switch-on delay
- Capacitive load

**Function key**

LED initial state

Pressing the button

LED, subsequent state  
Output, subsequent state

**General data**

- Relay to activate the output
- Protection degree
- Overvoltage category

**Signalling**

- LED green
- LED red

**Connection data**

- Number of terminals
- Wire cross-section, AWG/kcmil min/max
- Wire cross-section, flexible min/max
- Wire cross-section, rigid min/max
- Screwdriver blade

**Approvals**

Approvals

**Note**

**Ordering data**

**Rated current**

- 8.00 A
- 10.00 A

**Note**

**Accessories**

**Note**

**AMG ELM - xF Ex**



**Input**

- Yes
- 18...30 V DC
- 24 V DC
- 25 mA
- I<sub>OUT</sub> +30 mA
- 100 mVpp
- Suppressor diode

**Output**

- PUSH IN
- see characteristic curve
- 1 s
- 2082320000: 15,000 µF;
- 2082430000: 20,000 µF

**LED**

LED green, in operation      LED flashing red, load monitoring has triggered (disconnected)      LED red (permanently lit)

> 0.1 to 2 s (manual disconnect)      > 0.1 to 2 s (confirm and reset)      > 0.1 to 2 s (restart)

Red LED switched off      Red LED switched off      LED green switched on

**Relay**

No

**Protection degree**

IP20

**Overvoltage category**

III

**Operation (failure-free)**

Load monitoring has disconnected, Load monitoring has triggered (flashing), Internal error (rapid flashing)

**Approvals**

CE, TÜV (60950), cULus, UL 2367, GL-DNV, BV, ABS, LR, RINA, ISA 12.12.01, ATEX, IECEx

**Type**

Type	Qty.	Order No.
AMG ELM-8F EX	1	2082320000
AMG ELM-10F EX	1	2082430000

**Type**

Type	Qty.	Order No.
AMG DIS	10	2123050000
AMG MD	10	2122930000
AMG OD	10	2122910000
AMG PD	10	2122920000

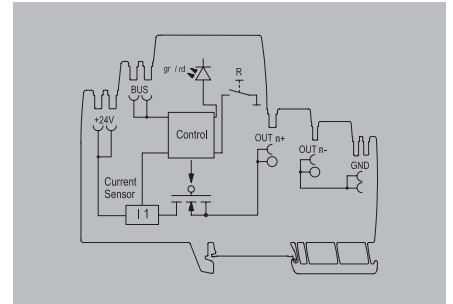

**Tripping characteristic normal – AMG ELM-8F Ex**

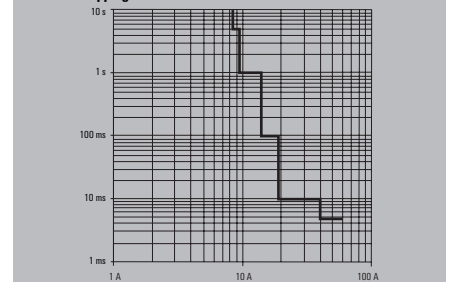

**Tripping characteristic normal – AMG ELM-10F Ex**

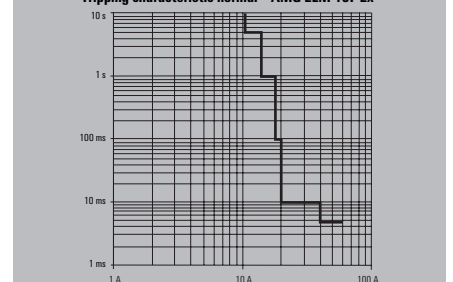

Technical data

Machinery

Process

Energy

Transportation

Device Manufacturers

Infrastructure

**maxGUARD – load monitoring adjustable**

Electronic load monitoring with adjustable triggering current and triggering characteristic

**AMG ELM-6 Ex**

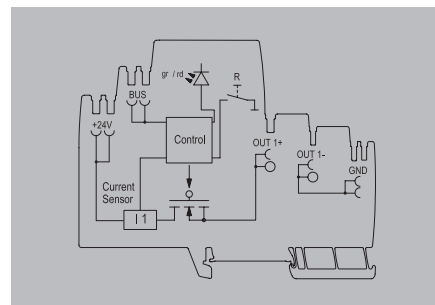

**Technical data**

Input	
Input fuse (internal)	Yes
DC input voltage range	18...30 V DC
Rated input voltage	24 V DC
Current consumption (idle)	25 mA
Current consumption (full load)	I <sub>OUT</sub> +30 mA
max. admissible residual ripple at the input	100 mVpp

Output	
Connection system	PUSH IN
Triggering characteristic	see characteristic curve
Backup modes	1- 6 A

Switch-on delay	1 s
Capacitive load	15,000 µF
adjustable rated current	Yes
Surge protection	Suppressor diode

Function key	
LED initial state	LED green, in operation

Pressing the button	> 0.1 to 2 s (manual disconnect)	> 0.1 to 2 s (confirm and reset)	> 0.1 to 2 s (restart)
---------------------	----------------------------------	----------------------------------	------------------------

LED, subsequent state	Red LED	Red LED	LED green
Output, subsequent state	switched off	switched off	switched on

General data	
Relay to activate the output	No
Protection degree	IP20
Overvoltage category	III

Signalling	
LED green	Operation (failure-free), Early warning: I <sub>Out</sub> > 90% I <sub>Rated</sub> (flashing)
LED red	Load monitoring has disconnected, Load monitoring has triggered (flashing), Internal error (rapid flashing)

Connection data	
Number of terminals	2 (+ / -)
Wire cross-section, AWG/kcmil min/max	26...12
Wire cross-section, flexible min/max	0.14...2.5 mm <sup>2</sup>
Wire cross-section, rigid min/max	0.14...2.5 mm <sup>2</sup>
Screwdriver blade	0.6 x 3.5

Approvals	
Approvals	CE, TÜV (60950), cULus, UL 2367, GL-DNV, BV, ABS, LR, RINA, ISA 12.12.01, ATEX, IECEx

Note	

**Ordering data**

Rated current	
	6.00 A

Note	

**Accessories**

Note	

Type	AMG ELM-6 EX	Qty.	1	Order No.	2082000000
------	--------------	------	---	-----------	------------

Type	AMG DIS	Qty.	10	Order No.	2123050000
Type	AMG MD	Qty.	10	Order No.	2122930000
Type	AMG OD	Qty.	10	Order No.	2122910000
Type	AMG PD	Qty.	10	Order No.	2122920000

Note	

Note	

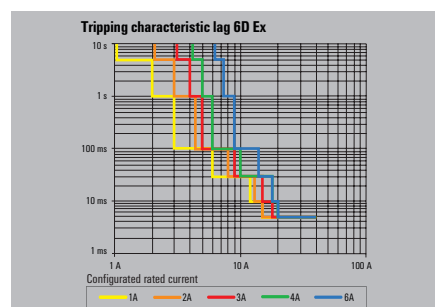
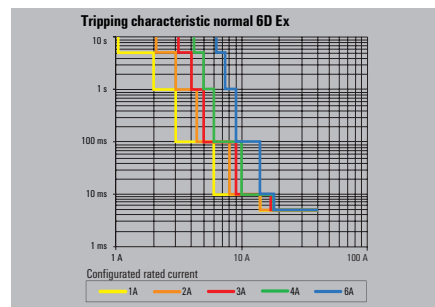

**maxGUARD – load monitoring adjustable**

Electronic load monitoring with adjustable trigger current and characteristic (with I > 90 % pre warning)

**AMG ELM-12 Ex**

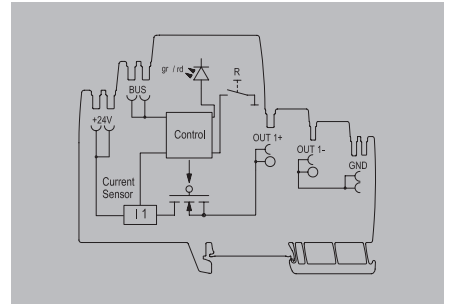

**Technical data**

**Input**

- Input fuse (internal)
- DC input voltage range
- Rated input voltage
- Current consumption (idle)
- Current consumption (full load)
- max. admissible residual ripple at the input

**Output**

- Connection system
- Triggering characteristic
- Backup modes

- Switch-on delay
- adjustable rated current
- Capacitive load
- Surge protection

**Function key**

LED initial state

Pressing the button

- LED, subsequent state
- Output, subsequent state

**General data**

- Relay to activate the output
- Protection degree
- Overvoltage category

**Signalling**

- LED green
- LED red

**Connection data**

- Number of terminals
- Wire cross-section, AWG/kcmil min/max
- Wire cross-section, flexible min/max
- Wire cross-section, rigid min/max
- Screwdriver blade

**Approvals**

Approvals

**Note**

**Ordering data**

Rated current 12.00 A

**Note**

**Accessories**

**Note**

**Input**

- Yes
- 18...30 V DC
- 24 V DC
- 25 mA
- I<sub>OUT</sub> +30 mA
- 100 mVpp

**Output**

- PUSH IN
- see characteristic curve
- 4-12 A

1 s

Yes

20,000 µF

Suppressor diode

LED green, in operation	LED flashing red, load monitoring has triggered (disconnected)	LED red (permanently lit)
-------------------------	--	---------------------------

> 0.1 to 2 s (manual disconnect)	> 0.1 to 2 s (confirm and reset)	> 0.1 to 2 s (restart)
----------------------------------	----------------------------------	------------------------

Red LED switched off	Red LED switched off	LED green switched on
----------------------	----------------------	-----------------------

No

IP20

III

Operation (failure-free), Early warning: I<sub>Out</sub> > 90% I<sub>Rated</sub> (flashing)  
 Load monitoring has disconnected, Load monitoring has triggered (flashing), Internal error (rapid flashing)

4 (++ / -)

26...12

0.14...2.5 mm<sup>2</sup>

0.14...2.5 mm<sup>2</sup>

0.6 x 3.5

CE, TÜV (60950), cULus, UL 2367, GL-DNV, BV, ABS, LR, RINA, ISA 12.12.01, ATEX, IECEx

Type	Qty.	Order No.
AMG ELM-12 EX	1	2082010000

Type	Qty.	Order No.
AMG DIS	10	2123050000
AMG MD	10	2122930000
AMG OD	10	2122910000
AMG PD	10	2122920000

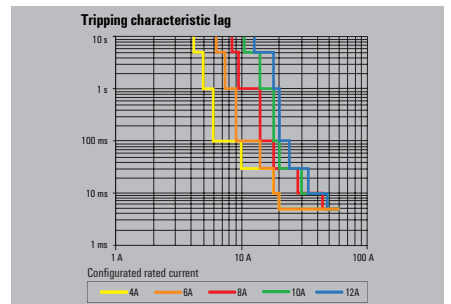
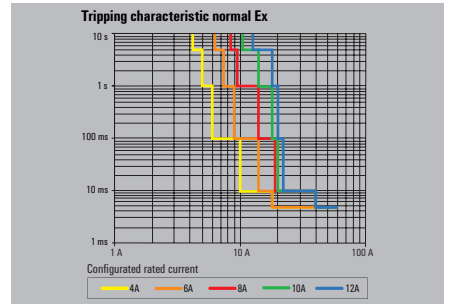

**maxGUARD – Alarm module**

Alarm module with potential-free contacts for the “Alarm” and “I>90%” signals.

**AMG AM CO**

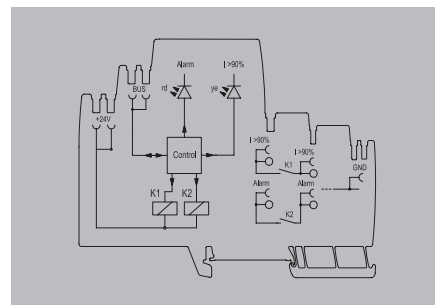

**Technical data**

Input	
Input fuse (internal)	No
DC input voltage range	18...30 V DC
Rated input voltage	24 V DC
Current consumption (idle)	25 mA
Current consumption (full load)	30 mA
max. admissible residual ripple at the input	100 mVpp
Surge protection	Suppressor diode
General data	
Protection degree	IP20
Overvoltage category	III
Signalling	
LED yellow	Current > 90% Inom (flashing)
LED red	Alarm
Floating contact	Yes
Status relay (max. load)	Alarm (24 V / 0.1 A), I > 90% (24 V / 0.1 A)
Connection data	
Number of terminals	4 (2x NO)
Wire cross-section, AWG/kcmil min/max	26...12
Wire cross-section, flexible min/max	0.14...2.5 mm <sup>2</sup>
Wire cross-section, rigid min/max	0.14...2.5 mm <sup>2</sup>
Screwdriver blade	0.6 x 3.5
Approvals	
Approvals	CE, TÜV (60950), cULus, UL 2367, GL-DNV, BV, ABS, LR, RINA, ISA 12.12.01, ATEX, IECEX

Input		
Input fuse (internal)	No	
DC input voltage range	18...30 V DC	
Rated input voltage	24 V DC	
Current consumption (idle)	25 mA	
Current consumption (full load)	30 mA	
max. admissible residual ripple at the input	100 mVpp	
Surge protection	Suppressor diode	
General data		
Protection degree	IP20	
Overvoltage category	III	
Signalling		
LED yellow	Current > 90% Inom (flashing)	
LED red	Alarm	
Floating contact	Yes	
Status relay (max. load)	Alarm (24 V / 0.1 A), I > 90% (24 V / 0.1 A)	
Connection data		
Number of terminals	4 (2x NO)	
Wire cross-section, AWG/kcmil min/max	26...12	
Wire cross-section, flexible min/max	0.14...2.5 mm <sup>2</sup>	
Wire cross-section, rigid min/max	0.14...2.5 mm <sup>2</sup>	
Screwdriver blade	0.6 x 3.5	
Approvals		
Approvals	CE, TÜV (60950), cULus, UL 2367, GL-DNV, BV, ABS, LR, RINA, ISA 12.12.01, ATEX, IECEX	

Note	
------	--

Note		
------	--	--

**Ordering data**

Rated current	
Note	

Type	Qty.	Order No.
AMG AM CO	1	2082770000

**Accessories**

Pluggable cross-connection	
50-pole	
50-pole / red	
50-pole / blue	
2-pole	
2-pole/ red	
2-pole / blue	
Note	

Type	Qty.	Order No.
ZQV 4N/50	5	1528130000
ZQV 4N/50 RD	5	2460730000
ZQV 4N/50 BL	5	1528240000
ZQV 4N/2	60	1527930000
ZQV 4N/2 RD	60	2460450000
ZQV 4N/2 BL	60	1528040000

Technical data

Machinery

Process

Energy

Transportation

Device Manufacturers

Infrastructure

**maxGUARD – control module**

Control module with extended control function: Alarm, Reset, I>90%, ON/OFF

**AMG CM Ex**

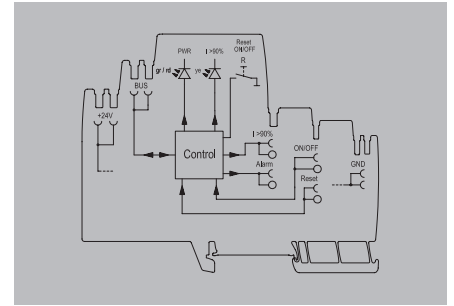

**Technical data**

Input	
DC input voltage range	18...30 V DC
Rated input voltage	24 V DC
Current consumption (idle)	25 mA
Current consumption (full load)	225 mA
max. admissible residual ripple at the input	100 mVpp
Output	
Connection system	PUSH IN
Surge protection	Suppressor diode
General data	
Relay to activate the output	No
Protection degree	IP20
Control inputs	ON/ OFF, Reset
Overvoltage category	III
Signalling	
LED green	Operation (failure-free), Early warning: I Out > 90% I Rated (flashing)
LED red	Load monitoring has disconnected, Load monitoring has triggered (flashing), Internal error (rapid flashing)
Transistor output, positive-switching	Pre-warning, Alarm
Connection data	
Number of terminals	2 (Reset / ON)
Wire cross-section, AWG/kcmil min/max	26...12
Wire cross-section, flexible min/max	0.14...2.5 mm <sup>2</sup>
Wire cross-section, rigid min/max	0.14...2.5 mm <sup>2</sup>
Screwdriver blade	0.6 x 3.5
Approvals	
Approvals	CE, TÜV (60950), cULus, UL 2367, GL-DNV, BV, ABS, LR, RINA, ISA 12.12.01, ATEX, IECEx
Note	

**Ordering data**

Rated current	
Note	

Type	Qty.	Order No.
AMG CM EX	1	2083360000

**Accessories**

Pluggable cross-connection	
50-pole	
50-pole / red	
50-pole / blue	
2-pole	
2-pole/ red	
2-pole / blue	
Note	

Type	Qty.	Order No.
ZQV 4N/50	5	1528130000
ZQV 4N/50 RD	5	2460730000
ZQV 4N/50 BL	5	1528240000
ZQV 4N/2	60	1527930000
ZQV 4N/2 RD	60	2460450000
ZQV 4N/2 BL	60	1528040000

Technical data

Machinery

Process

Energy

Transportation

Device Manufacturers

Infrastructure

**maxGUARD – Potential distributor**

Potential distribution in combination with the electronic load monitoring.

**AMG**

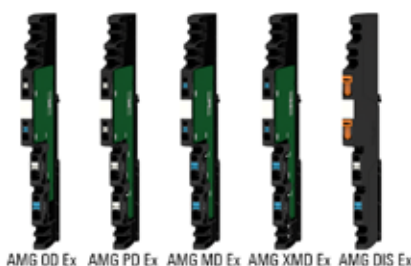

AMG OD Ex AMG PD Ex AMG MD Ex AMG XMD Ex AMG DIS Ex

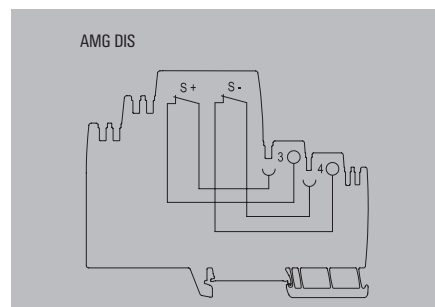
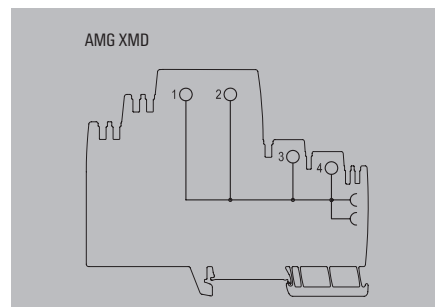
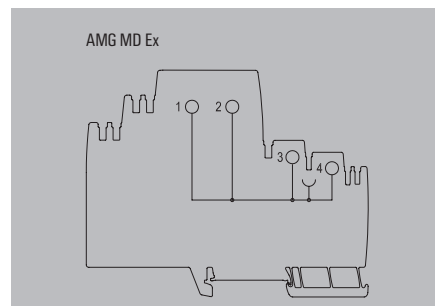
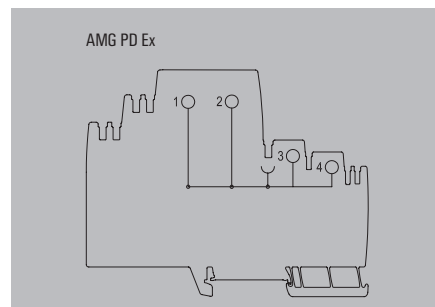
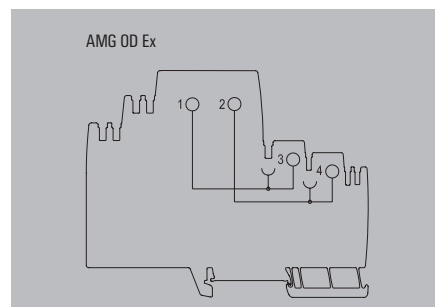

**Technical data**

**General data**

Protection degree  
Total current load per potential

IP20

2495090000: 12 A;  
2495070000: 12 A;  
2495040000: 12 A;  
2495080000: 24 A;  
2495100000: 12 A

12 A

Current load per contact point

**Connection data**

Connection system  
Number of terminals  
Wire cross-section, AWG/kcmil min/max  
Wire cross-section, flexible min/max  
Wire cross-section, rigid min/max  
Screwdriver blade

PUSH IN

2 x 1.5 mm<sup>2</sup>, 2 x 2.5 mm<sup>2</sup>  
26...12

0.14...2.5 mm<sup>2</sup>

0.14...2.5 mm<sup>2</sup>

0.6 x 3.5

**Approvals**

Approvals

CE, TÜV (60950), cULus, UL 2367, GL-DNV, BV, ABS, LR, RINA, ISA 12.12.01, ATEX, IECEx

**Note**

**Ordering data**

Type	Qty.	Order No.
AMG OD EX	1	2495090000
AMG PD EX	1	2495070000
AMG MD EX	10	2495040000
AMG XMD EX	1	2495080000
AMG DIS EX	1	2495100000

**Note**

**Accessories**

**Pluggable cross-connection**

50-pole  
50-pole / red  
50-pole / blue  
2-pole  
2-pole/ red  
2-pole / blue

Type	Qty.	Order No.
ZQV 4N/50	5	1528130000
ZQV 4N/50 RD	5	2460730000
ZQV 4N/50 BL	5	1528240000
ZQV 4N/2	60	1527930000
ZQV 4N/2 RD	60	2460450000
ZQV 4N/2 BL	60	1528040000

**Note**

Technical data

Machinery

Process

Energy

Transportation

Device Manufacturers

Infrastructure

maxGUARD – accessories

Cross-connector orange



Type	Qty.	Order No.
ZQV 4N/2	60	1527930000
ZQV 4N/3	60	1527940000
ZQV 4N/4	60	1527970000
ZQV 4N/5	60	1527980000
ZQV 4N/6	20	1527990000
ZQV 4N/7	20	1528020000
ZQV 4N/8	20	1528030000
ZQV 4N/9	20	1528070000
ZQV 4N/10	20	1528090000
ZQV 4N/50	5	1528130000

Cross-connector blue



Type	Qty.	Order No.
ZQV 4N/2 BL	60	1528040000
ZQV 4N/3 BL	60	1528080000
ZQV 4N/4 BL	60	1528120000
ZQV 4N/5 BL	60	1528140000
ZQV 4N/6 BL	20	1528170000
ZQV 4N/7 BL	20	1528180000
ZQV 4N/8 BL	20	1528190000
ZQV 4N/9 BL	20	1528220000
ZQV 4N/10 BL	20	1528230000
ZQV 4N/50 BL	5	1528240000

Cross-connector red



Type	Qty.	Order No.
ZQV 4N/2 RD	60	2460450000
ZQV 4N/3 RD	60	2460810000
ZQV 4N/4 RD	60	2460800000
ZQV 4N/5 RD	60	2460790000
ZQV 4N/6 RD	20	2460780000
ZQV 4N/7 RD	20	2460770000
ZQV 4N/8 RD	20	2460760000
ZQV 4N/9 RD	20	2460750000
ZQV 4N/10 RD	20	2460740000
ZQV 4N/50 RD	5	2460730000

maxGUARD – accessories

End plate and Separation plate



Type	Qty.	Order No.
AMG PP	40	2123000000
AMG EP	30	2495380000
AMG EP KIT	1	2500760000

End brackets



Type	Qty.	Order No.
WEW 35/2 SW	100	1061210000
WEW 35/2 V0 GF SW	100	1479000000

Cutting tool for ZQV



Type	Qty.	Order No.
KT 14	1	1157820000



### IO-Link module

- Connection for 4 IO-Link devices
- IO-Link standard according to IEC 61131-9
- Protocol support IO-Link v.1.0 and v.1.1
- Automatic communication via COM 1, COM 2 and COM 3
- Max. 20 m wire length
- Internal data width 4-32 bytes, configurable

### UR20-4COM-IO-LINK



#### Technical data

System data	
Interface	u-remote system bus
Transmission speed of system bus, max.	48
Galvanic isolation	500 V DC between the current paths
Supply	
Supply voltage	24 V DC +20%/-15%, via the system bus
Current consumption I <sub>m</sub> (power segment of the field bus coupler), typ.	8 mA
Current consumption I <sub>m</sub> (the respective power segment)	25 mA + sensor feed
IO-Link-Interface	
Number	4
Connection type	IO-Link
Output current	0.1 A C/Q (DO MODE), 0.5 A L+
IO link standard	IEC 61131-9
Short-circuit-proof	Yes
Module diagnosis	Yes
Individual channel diagnosis	Yes
Class	A
Digital inputs	
Number	4
Type	Types 1 and 3, EN 61131-2
Input voltage, low	< 5 V
Input voltage, high	> 11 V
General data	
Weight	88 g
Dimensions H x W x D	120 / 11.5 / 76 mm
Note	

Type		
UR20-4COM-IO-LINK	1	1315740000

#### Ordering data

Module variants	
Digital communication module, 4 channels	
Note	

Type	Qty.	Order No.
UR20-4COM-IO-LINK	1	1315740000

#### Accessories

Coding elements	
Termination kit	
Swivel marker	
Connection marker for pusher custom printing	
Connection marker for pusher neutral	
Module marker for custom printing	
Module marker for neutral	
Thermotransfer version (Material: Polyester)	
Thermotransfer version (material: polyester)	
Paper version for Laserprinter	
Replacement parts	
Electronic module	
Basic module	
Plug-in connector unit	
Note	

Type	Qty.	Order No.
KOSM BHZ5.00	100	1483050000
UR20-EBK-ACC	5	1346610000
UR20-SM-ACC	20	1339920000
PM 2.7/2.6 MC SDR	192	1323700000
PM 2.7/2.6 MC NE WS	960	1323710000
DEK 5/8-11.5 MC SDR	100	1341610000
DEK 5/8-11.5 MC NE WS	500	1341630000
THM UR20 GE	1	1429910000
THM UR20 WS	1	1429420000
ESO UR20 DIN A4 WS	10	1429430000
UR20-EM-1315740000-SP	1	1347340000
UR20-BM-SP	5	1350930000
UR20-PK-1315740000-SP	5	2508760000
1 roll = 1000 label = 1 Qty. 1 sheet = 60 label = 1 Qty.		

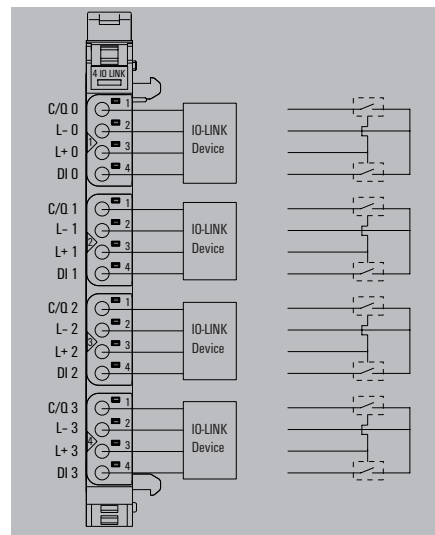

Product standard	IEC 61131-2, IEC61010-2-201
EMC	EN 61000
ATEX (in preparation)	EN 60079
UL (in preparation)	UL 61010-2-201
MSIP (in preparation)	MSIP-REM-WMG-1315740000



Let's connect.



## ModbusTCP V2

- Dual LAN mode
- 2 x 10 A current paths
- Various Modbus services
- Web server
- System supply of 64 I/O modules
- Temperature range -20... +60 °C

## UR20-FBC-MOD-TCP-V2



### Technical data

System data	
Connection type	2 x RJ45 plug-in connectors
Field bus protocol	Modbus/TCP
Process data	8 kByte
Parameter data	1024 Byte
Diagnostic data	1024 Byte
max. number of modules	64
Configuration interface	Micro USB 2.0
Fieldbus interface	Full / Half Duplex, Auto MDI/X, Autonegotiation
Transmission rate of field bus, max.	100 Mbit/s
Transmission speed of system bus, max.	48 Mbit/s
Supply	
Supply voltage system and inputs	24 V DC +20%/ -15%
Supply voltage for outputs	24 V DC +20%/ -15%
Feed current for I <sub>in</sub> (input current path) , max.	10 A
Feed current for I <sub>out</sub> (output current path) , max.	10 A
Current consumption I <sub>m</sub> (power segment of the field bus coupler), typ.	112 mA
General data	
Weight	319 g
Dimensions H x W x D	120 mm / 52 mm / 76 mm
Note	

24 V DC +20%/ -15%	24 V DC +20%/ -15%	10 A	10 A	112 mA
319 g	120 mm / 52 mm / 76 mm			

### Ordering data

Module variants	
	Field bus coupler, ModbusTCP
Note	

Type	Qty.	Order No.
UR20-FBC-MOD-TCP-V2	1	2476450000
A termination kit (UR20-EBK-ACC) is included in the coupler package		

### Accessories

Coding elements	
Termination kit	
Swivel marker	
Connection marker for pusher custom printing	
Connection marker for pusher neutral	
Module marker for custom printing	
Module marker for neutral	
Thermotransfer version (Material: Polyester)	
Thermotransfer version (material: polyester)	
Paper version for Laserprinter	
USB cable (USB A to Micro USB)	
Replacement parts	
	Plug-in connector unit
Note	

Type	Qty.	Order No.
KOSM BHZ5.00	100	1483050000
UR20-EBK-ACC	5	1346610000
UR20-SM-ACC	20	1339920000
PM 2.7/2.6 MC SDR	192	1323700000
PM 2.7/2.6 MC NE WS	960	1323710000
DEK 5/8-11.5 MC SDR	100	1341610000
DEK 5/8-11.5 MC NE WS	500	1341630000
THM UR20 GE	1	1429910000
THM UR20 WS	1	1429420000
ESD UR20 DIN A4 WS	10	1429430000
IE-USB-A-MICRO-1.8M	1	1487980000
Replacement parts		
UR20-PK-2476450000-SP	5	2485280000
1 roll = 1000 label = 1 Qty. 1 sheet = 60 label = 1 Qty.		

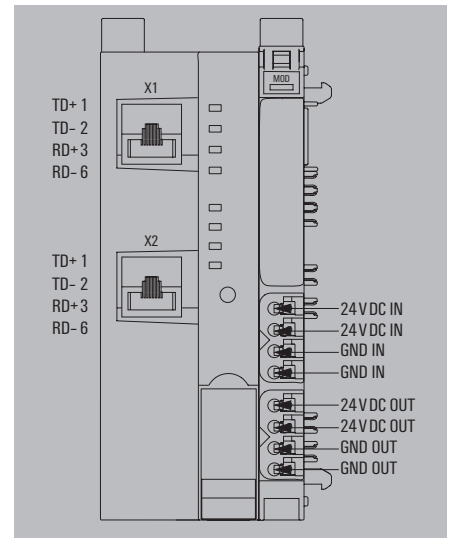

Product standard	IEC 61131-2, IEC61010-2-201
EMC	EN 61000
ATEX (in preparation)	EN 60079
UL (in preparation)	UL 61010-2-201
MSIP (in preparation)	MSIP-REM-WMG-2476450000



Let's connect.

Approvals for the use in marine- and offshore-applications

u-remote has been approved for use in the maritime and offshore sector: DNV GL (formerly Det Norske Veritas and Germanischer Lloyd), Bureau Veritas (BV), Lloyds Register (LR) and Registro Italiano Navale (RINA) are the first international classification societies to certify the use of the innovative remote I/O system in this demanding environment. The certification is valid for almost all areas on a ship, including the ship's bridge, which is subject to particularly high demands.

u-remote's robust design is suited to both the sensitive and harsh environmental conditions found on a ship, as well as a wide range of temperatures (-20°C to 60°C). It can withstand high levels of humidity (up to 100%), intense vibration (up to 4 g) and high-energy electromagnetic fields, without emitting high levels of radiation that could affect other devices.

Type	Order No.	DNV/GL	BV	LR	RINA	ABS
UR20-FBC-PB-DP	1334870000	x*	x*	x*	x*	x*
UR20-FBC-PN-IRT	1334880000	x*	x*	x*	x*	x*
UR20-FBC-EC	1334910000	x	x	x	x	x*
UR20-FBC-MOD-TCP	1334930000					
UR20-FBC-MOD-TCP-V2	2476450000	x	x	x	x	x*
UR20-FBC-DN	1334900000	x*	x*	x*	x*	x*
UR20-FBC-CAN	1334890000	x	x	x	x	x*
UR20-FBC-EIP	1334920000	x*	x*	x*	x*	x*
UR20-FBC-PL	1334940000	x	x	x	x	x*
UR20-4DI-P	1315170000	x	x	x	x	x*
UR20-8DI-P-2W	1315180000	x	x	x	x	x*
UR20-8DI-P-3W	1394400000	x	x	x	x	x*
UR20-16DI-P	1315200000	x	x	x	x	x*
UR20-16DI-P-PLC-INT	1315210000	x	x	x	x	x*
UR20-4DI-P-TS	1460150000	x	x	x	x	x*
UR20-4DI-N	1315350000	x	x	x	x	x*
UR20-8DI-N-3W	1315370000	x	x	x	x	x*
UR20-16DI-N	1315390000	x	x	x	x	x*
UR20-16DI-N-PLC-INT	1315400000	x	x	x	x	x*
UR20-4DI-2W-230V-AC	1550070000	x	x	x	x	x*
UR20-4DO-P	1315220000	x	x	x	x	x*
UR20-4DO-P-2A	1315230000	x	x	x	x	x*
UR20-4DO-PN-2A	1394420000	x	x	x	x	x*
UR20-8DO-P	1315240000	x	x	x	x	x*
UR20-16DO-P	1315250000	x	x	x	x	x*
UR20-16DO-P-PLC-INT	1315270000	x	x	x	x	x*
UR20-4DO-N	1315410000	x	x	x	x	x*
UR20-4DO-N-2A	1315420000	x*	x*	x*	x*	x*
UR20-8DO-N	1315430000	x	x	x	x	x*
UR20-16DO-N	1315440000	x	x	x	x	x*
UR20-16DO-N-PLC-INT	1315450000	x	x	x	x	x*
UR20-4RO-SSR-255	1315540000	x	x	x	x	x*
UR20-4RO-CO-255	1315550000	x	x	x	x	x*
UR20-1CNT-100-100	1315570000	x	x	x	x	x*
UR20-1CNT-500	1315580000	x*	x*	x*	x*	x*
UR20-2CNT-100	1315590000	x*	x*	x*	x*	x*
UR20-2FCNT-100	1508080000	x*	x*	x*	x*	x*
UR20-1SSI	1508090000	x*	x*	x*	x*	x*
UR20-1COM-232-422-485	1315750000	x	x	x	x	x*
UR20-2PWM-PN-0.5A	1315600000					
UR20-2PWM-PN-2A	1315610000					
UR20-4AI-UI-12	1394390000	x*	x*	x*	x*	x*
UR20-4AI-UI-16	1315620000	x*	x*	x*	x*	x*
UR20-4AI-UI-16-DIAG	1315690000	x*	x*	x*	x*	x*
UR20-4AI-UI-DIF-16-DIAG	1993880000	x*	x*	x*	x*	x*
UR20-8AI-I-PLC-INT	1315670000	x*	x*	x*	x*	x*
UR20-2AI-SG-24-DIAG	1990070000	x*	x*	x*	x*	x*
UR20-4AI-TC-DIAG	1315710000	x	x	x	x	x*
UR20-4AI-RTD-DIAG	1315700000	x	x	x	x	x*
UR20-3EM-230V-AC	2007420000	x*	x*	x*	x*	x*
UR20-4AO-UI-16-M	2453880000	x*	x*	x*	x*	x*
UR20-4AO-UI-16-M-DIAG	2453870000	x*	x*	x*	x*	x*
UR20-PF-I	1334710000	x	x	x	x	x*
UR20-PF-O	1334740000	x	x	x	x	x*
UR20-PF-O-1DI-SIL	1335030000	x*	x*	x*	x*	x*
UR20-PF-O-2DI-DELAY-SIL	1335040000	x*	x*	x*	x*	x*
UR20-PF-O-2DI-SIL	1335050000	x*	x*	x*	x*	x*
UR20-16AUX-I	1334770000	x	x	x	x	x*
UR20-16AUX-O	1334780000	x	x	x	x	x*
UR20-16AUX-FE	1334790000	x	x	x	x	x*
UR20-16AUX-GND-I	1334800000	x	x	x	x	x*
UR20-16AUX-GND-O	1334810000	x	x	x	x	x*
UR20-ES	1315770000	x*	x*	x*	x*	x*
<b>Hinweis</b>	* Approval is only available as of Q3/2017					

Technical data

Machinery

Process

Energy

Transportation

Device Manufacturers

Infrastructure

## POWERLINK

- 2 x 10 A current paths
- Address can be set using rotary switch
- Web server
- System supply of 64 I/O modules
- Temperature range -20... +60 °C

## UR20-FBC-PL



### Technical data

System data	
Connection type	2 x RJ45 plug-in connectors
Field bus protocol	POWERLINK
Process data	2980 Byte
Parameter data	4 kByte
Diagnostic data	3008 Byte
max. number of modules	64
Configuration interface	Micro USB 2.0
Transmission rate of field bus, max.	100 Mbit/s
Transmission speed of system bus, max.	48 Mbit/s
Supply	
Supply voltage system and inputs	24 V DC +20%/-15%
Supply voltage for outputs	24 V DC +20%/-15%
Feed current for I <sub>IN</sub> (input current path) , max.	10 A
Feed current for I <sub>OUT</sub> (output current path) , max.	10 A
Current consumption I <sub>IN</sub> (power segment of the field bus coupler), typ.	100 mA
General data	
Weight	318 g
Dimensions H x W x D	120 mm / 52 mm / 76 mm
Note	
Download of XDD-files on <a href="http://www.weidmueller.com">www.weidmueller.com</a>	

### Ordering data

Module variants	
Type	Qty. Order No.
UR20-FBC-PL	1 1334940000
A termination kit (UR20-EBK-ACC) is included in the coupler package	

### Accessories

Type	Qty.	Order No.
Coding elements	100	1483050000
Termination kit	5	1346610000
Swivel marker	20	1339920000
Connection marker for pusher custom printing	192	1323700000
Connection marker for pusher neutral	960	1323710000
Module marker for custom printing	100	1341610000
Module marker for neutral	500	1341630000
Thermotransfer version (Material: Polyester)	1	1429910000
Thermotransfer version (material: polyester)	1	1429420000
Paper version for Laserprinter	10	1429430000
USB cable (USB A to Micro USB)	1	1487980000
Replacement parts		
Plug-in connector unit	5	2425170000
Note		

Type	Qty.	Order No.
KOSM BHZ5.00	100	1483050000
UR20-EBK-ACC	5	1346610000
UR20-SM-ACC	20	1339920000
PM 2.7/2.6 MC SDR	192	1323700000
PM 2.7/2.6 MC NE WS	960	1323710000
DEK 5/8-11.5 MC SDR	100	1341610000
DEK 5/8-11.5 MC NE WS	500	1341630000
THM UR20 GE	1	1429910000
THM UR20 WS	1	1429420000
ESO UR20 DIN A4 WS	10	1429430000
IE-USB-A-MICRO-1.8M	1	1487980000
UR20-PK-1334940000-SP	5	2425170000

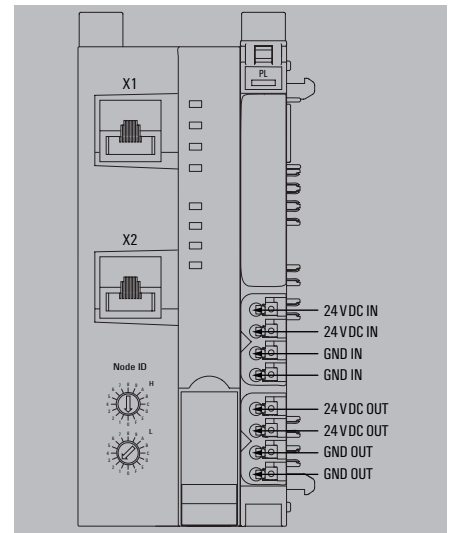

Product standard	IEC 61131-2, IEC61010-2-201
EMC	EN 61000
ATEX (in preparation)	EN 60079
UL (in preparation)	UL 61010-2-201
MSIP (in preparation)	MSIP-REM-WMG-1334940000



Let's connect.

**2AI-SG-24-DIAG**

- 2 differential inputs for DMS
- 24-bit resolution
- 4- or 6-wire connection
- Accuracy ±0.01% FSR
- Individual channel diagnosis

**UR20-2AI-SG-24-DIAG**



**Technical data**

System data	
Interface	u-remote system bus
Transmission speed of system bus, max.	48 Mbit
Galvanic isolation	500 V DC between the current paths
Supply	
Supply voltage	24 V DC +20%/-15%, via the system bus
Current consumption I <sub>m</sub> (power segment of the field bus coupler), typ.	8 mA
Current consumption I <sub>m</sub> (the respective power segment)	35 mA
Analogue inputs	
Number	2
Input value	Differential, to evaluate a strain gauge full-bridge
Resolution	24 bit per channel
Accuracy	Customer calibration: ±0.01% FSR (100 ppm), ±1% FSR (with interference)
Supported sensor sensitivity	0.5 mV - 30 V, parameterisable
Temperature coefficient	< 5 ppm/K
Permissible sensor load	85 ... 5000 Ω
Conversion time	5 - 800 ms, parameterisable
Measurement range	± 150 mV
Module diagnosis	Yes
Individual channel diagnosis	Yes
Short-circuit-proof	Yes
Digital inputs	
Input filter	10 ms
Input voltage, high	> 11 V
Input voltage, low	< 5 V
Individual channel diagnosis	Yes
Short-circuit-proof	Yes
Module diagnosis	Yes
Type	Types 1 and 3, EN 61131-2
General data	
Weight	89.7 g
Dimensions H x W x D	11.5 mm / 120 mm / 76 mm
Note	

Type	Qty.	Order No.
UR20-2AI-SG-24-DIAG	1	1990070000

**Ordering data**

Module variants	
	Strain gauge module, 2 channels
Note	

**Accessories**

	Coding elements	100	1483050000
	Termination kit	5	1346610000
	Swivel marker	20	1339920000
Connection marker for pusher custom printing	PM 2.7/2.6 MC SDR	192	1323700000
Connection marker for pusher neutral	PM 2.7/2.6 MC NE WS	960	1323710000
Module marker for custom printing	DEK 5/8-11.5 MC SDR	100	1341610000
Module marker for neutral	DEK 5/8-11.5 MC NE WS	500	1341630000
Thermotransfer version (Material: Polyester)	THM UR20 GE	1	1429910000
Thermotransfer version (material: polyester)	THM UR20 WS	1	1429420000
Paper version for Laserprinter	ESO UR20 DIN A4 WS	10	1429430000
Replacement parts			
	Electronic module	5	1562260000
	Basic module	5	1350930000
	Plug-in connector unit	5	2068620000
Note			

Type	Qty.	Order No.
UR20-EM-1990070000-SP	5	1562260000
UR20-BM-SP	5	1350930000
UR20-PK-1990070000-SP	5	2068620000

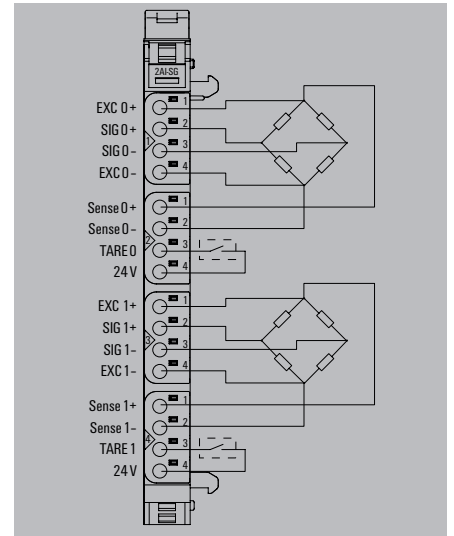

Product standard	IEC 61131-2, IEC61010-2-201
EMC	EN 61000
ATEX (in preparation)	EN 60079
UL (in preparation)	UL 61010-2-201
MSIP (in preparation)	MSIP-REM-WMG-1990070000



Let's connect.

**PROFINET**  
Remote I/O for digital signal conditioning



**UR67-PN-HP-8IOL-12-30M**



**UR67-PN-HP-8IOL-12-60M**



**Ordering data**

Module variants
IO-Link, 4x Type A, 4x Type B
Note

Type	Qty.	Order No.
UR67-PN-HP-8IOL-12-30M	1	2426250000
Note		

Type	Qty.	Order No.
UR67-PN-HP-8IOL-12-60M	1	2426260000
Note		

Connections
Fieldbus (BUS-IN)
Fieldbus (BUS-OUT)
Supply voltage (AUX-IN)
Supply voltage (AUX-OUT)
I/O connections
Voltage supply
Operating voltage
Power consumption of module electronics
Digital inputs
IO link standard
Galvanic isolation
Input current, low
Input current, high
Reverse polarity protection
Short-circuit protection
Overload protection
Status indicator
Diagnostic display
Digital outputs
max. current-carrying capacity per output signal
Output voltage, low
Output voltage, high
Max. total current outputs
Reverse polarity protection
Short-circuit protection
Overload protection
Status indicator
Diagnostic display
Fieldbus
Bus system
Transmission rate
Addressing
General data
L x W x H
Weight
Protection degree
Operating temperature
Housing main material / UL 94 flammability rating

1x M12 female 4-pole, D-coded		
1x M12 female 4-pole, D-coded		
1x M12 plug 5-pole, L-coded		
1x M12 socket 5-pole, L-coded		
8 x M12 socket 5-pole, A-coded		
Note		
24 V (18 V DC ... 30 V DC)		
160 mA typical		
Note		
IO-Link v.1.1, IEC 61131-9		
2000 V DC		
Type 1 in acc. with IEC 61131-2		
Type 1 in acc. with IEC 61131-2		
Yes		
Yes		
Yes		
Per channel, via LED, yellow		
Per channel, via LED, red		
Note		
0.5 A, 2 A		
- 1 V		
max. 2 V		
9 A		
Yes		
Yes		
Yes		
Per channel, via LED, yellow		
Per channel, via LED, red		
Note		
PROFINET V2.3		
10/100 Mbit/s		
DCP		
Note		
225 mm / 30 mm / 30 mm		
480 g		
IP67		
-20 °C...70 °C		
Zinc diecast / UL 94		

1x M12 female 4-pole, D-coded		
1x M12 female 4-pole, D-coded		
1x M12 plug 5-pole, L-coded		
1x M12 socket 5-pole, L-coded		
8 x M12 socket 5-pole, A-coded		
Note		
24 V (18 V DC ... 30 V DC)		
160 mA typical		
Note		
IO-Link v.1.1, IEC 61131-9		
2000 V DC		
Type 1 in acc. with IEC 61131-2		
Type 1 in acc. with IEC 61131-2		
Yes		
Yes		
Yes		
Per channel, via LED, yellow		
Per channel, via LED, red		
Note		
0.5 A, 2 A		
- 1 V		
max. 2 V		
9 A		
Yes		
Yes		
Yes		
Per channel, via LED, yellow		
Per channel, via LED, red		
Note		
PROFINET V2.3		
10/100 Mbit/s		
DCP		
Note		
200 mm / 59.6 mm / 17.6 mm		
500 g		
IP67		
-20 °C...70 °C		
Zinc diecast / UL 94		

Note
------

Note
------

Note
------

Technical data  
 Machinery  
 Process  
 Energy  
 Transportation  
 Device Manufacturers  
 Infrastructure

### FieldPower® Box with maintenance switch and fuses

- 5-pole power distribution 3~, N, PE
- Lockable maintenance switch acc. to IEC 60947-3
- Fuse terminal block for three safety fuses
- With local LED failure indicator and failure message via M12 (PIN 1 = external 24 V DC ± 20%, PIN 2 = switch, PIN 3 = GND, PIN 4 = fuse)
- Depending on configuration for safety fuses type CC or type 10 x 38 mm (max. 32 A)
- Max. 3 W for gG/gL, max. 1.2 W for aM depending on the ambient temperature

### FP Box ON/OFF16A FUSE R



#### Technical data

General data	
Dimensions	181 / 192 / 165 mm
Ambient temperature	-25 °C...+45 °C
Temperature range, assembly, min. / max.	10...40 °C
Storage temperature	-25 °C...70 °C
Material colour	Black
Protection degree	IP65
Insulating material	Polycarbonate
UL 94 flammability rating	5VA
Rated voltage	400 V
Rated impulse withstand voltage	4 kV
IDC connection for power distribution	
Rated current	41 A
Rated current branch	16 A
Clamping range, rated connection, min./max.	2.5 / 6 mm <sup>2</sup>
Blade size	0.6 x 3.5 mm
PUSH IN connection distribution	
Clamping range, rated connection, min./max.	0.5...6 mm <sup>2</sup>
Connection cross-section, flexible, min. / max.	0.5...10 mm <sup>2</sup>
Blade size	0.6 x 3.5 mm
Stripping length, PUSH IN connection	14 mm
Technical data switch	
Rated current AC-23A	16 A
Clamping range, rated connection, min./max.	0.75 / 10 mm <sup>2</sup>
Terminals - torque	0.8 Nm
Technical data of fuse holder	
Cartridge fuse	10 x 38 mm
<b>Note</b>	

#### Ordering data

Type	Qty.	Order No.
FP Box ON/OFF16A FUSE R	1	8000028513

Included in delivery: three 10 x 38 safety fuses 16 A gG; six enclosure seals: 3x 432324000, 2x 432323000, 1x 432321000

#### Accessories

Type	Qty.	Order No.
Blanking seal	10	4323240000
Round-cable seal, slit 1x 7.5 - 9mm	10	4329610000
Round-cable seal, slit 1x 9 - 11mm	10	4323210000
Round-cable seal, slit 1x 11 - 13mm	10	4323230000
Round-cable seal, slit 1x 13 - 15mm	10	4323220000
Round-cable seal, slit 1x 15 - 17mm	10	4324010000
<b>Note</b>		

Type	Qty.	Order No.
DG D0 PT6	10	4323240000
RKDG D9 PT6	10	4329610000
RKDG D11 PT6	10	4323210000
RKDG D13 PT6	10	4323230000
RKDG D15 PT6	10	4323220000
RKDG D17 PT6	10	4324010000

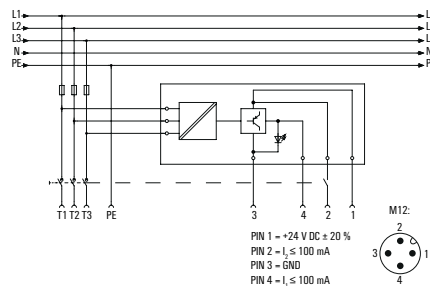



Infrastructure



Device  
Manufacturers



Transportation



Energy



Process



Machinery

Technical data

Energy management – Connectivity Boxes

Ordering data

Type	Degree of protection	Dimensions (h x w x d)	Material	Order No.
EM-Connectivity-Box 96	IP 54	310 x 230 x 111 mm	Aluminium	8000028950
EM-Connectivity-Box TS	IP 65	310 x 230 x 111 mm	Aluminium	8000028951
EM-Connectivity-Box 144	IP 42	430 x 250 x 120 mm	Plastic	8000028952
LST EM-BLOCK*				8000028895
<b>Note</b>	* Test-disconnect terminal blocks with fuse mounted on terminal rail			

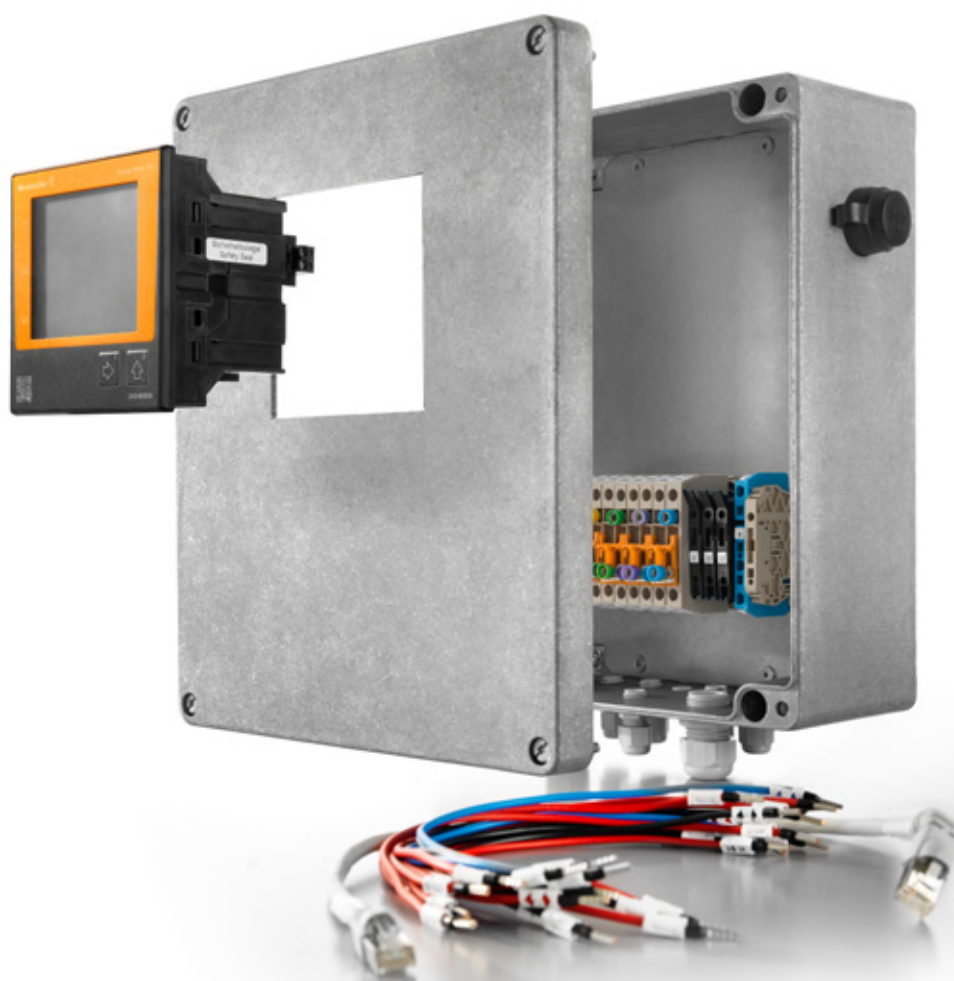

Technical data

Machinery

Process

Energy

Transportation

Device Manufacturers

Infrastructure





Infrastructure



Device  
Manufacturers



Transportation



Energy



Process



Machinery

Technical data

Energy analysis instruments

Energy Analyser D550-24



Technical data

Supply voltage	20 ... 50 V AC ±10%, 20 ... 70 V DC ±10%
<b>General data</b>	
Measuring accuracy for voltage	0.2 %
Measuring accuracy for current	0.2 %
Measurement accuracy for active energy (kWh, .../5 A)	Class 0.5S
<b>Voltage quality measurement</b>	
Harmonics, per order / current	1-40.
Harmonics, per order / voltage	1-40.
Distortion factor THD-U in %	Yes
Distortion factor THD-I in %	Yes
<b>Measurement data recording</b>	
Memory (Flash)	128 MB
<b>Display and inputs/outputs</b>	
Display	LCD with backlit display, 2 keys
Digital inputs	2
Digital outputs	2 as switch or pulse output
Temperature measurement input (PT100, PT1000, KTY83, KTY84)	1
<b>Communication</b>	
Interface	RS485: Autobaud, 9.6 - 115.2 kbps (pluggable screw terminals), Ethernet 10/100 Base-TX (RJ-45 socket), RS232: 9.6 - 115.2 kbps
<b>Protocol</b>	
Protocol	TCP/IP, DHCP Client (BootP), Modbus/TCP (Port 502), ICMP (Ping), NTP, Modbus RTU over Ethernet (Port 8000), TFTP
<b>Measuring-voltage input</b>	
Measurement range, voltage L-N, AC (without converter)	10...600 Vrms
Measurement range, voltage L-L, AC (without converter)	18...1000 Vrms
<b>Measuring-current input</b>	
Rated current	1 / 5 A
<b>Note</b>	

Supply voltage	20 ... 50 V AC ±10%, 20 ... 70 V DC ±10%
<b>General data</b>	
Measuring accuracy for voltage	0.2 %
Measuring accuracy for current	0.2 %
Measurement accuracy for active energy (kWh, .../5 A)	Class 0.5S
<b>Voltage quality measurement</b>	
Harmonics, per order / current	1-40.
Harmonics, per order / voltage	1-40.
Distortion factor THD-U in %	Yes
Distortion factor THD-I in %	Yes
<b>Measurement data recording</b>	
Memory (Flash)	128 MB
<b>Display and inputs/outputs</b>	
Display	LCD with backlit display, 2 keys
Digital inputs	2
Digital outputs	2 as switch or pulse output
Temperature measurement input (PT100, PT1000, KTY83, KTY84)	1
<b>Communication</b>	
Interface	RS485: Autobaud, 9.6 - 115.2 kbps (pluggable screw terminals), Ethernet 10/100 Base-TX (RJ-45 socket), RS232: 9.6 - 115.2 kbps
<b>Protocol</b>	
Protocol	TCP/IP, DHCP Client (BootP), Modbus/TCP (Port 502), ICMP (Ping), NTP, Modbus RTU over Ethernet (Port 8000), TFTP
<b>Measuring-voltage input</b>	
Measurement range, voltage L-N, AC (without converter)	10...600 Vrms
Measurement range, voltage L-L, AC (without converter)	18...1000 Vrms
<b>Measuring-current input</b>	
Rated current	1 / 5 A
<b>Note</b>	

Ordering data

<b>Note</b>
-------------

Type	Qty.	Order No.
ENERGY ANALYSER D550-24	1	2489780000

Technical data

Machinery

Process

Energy

Transportation

Device Manufacturers

Infrastructure



Infrastructure



Device  
Manufacturers



Transportation



Energy



Process



Machinery

Technical data

**Resistance measurement transducer with limit relay**

- Configurable from buttons and display
- Monitoring of resistance changes(e.g: motor winding / heating resistors)
- Analogue and digital output
- Removable terminals

**ACT20P-PRO-RTCI-AO-DO**

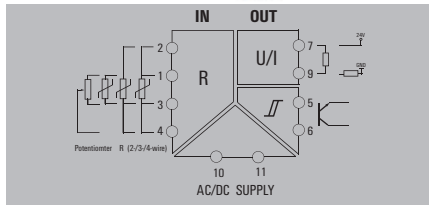

**Technical data**

<b>Input</b>	
Number of inputs	1
Input resistance	0... 15 kΩ
Potentiometer	10... 150 kΩ
<b>Output (digital)</b>	
Number of outputs	1
Alarm function	configurable, Top and bottom limit values, window range, Short circuit at input, Alarm delay: 0...10 s, Hysteresis: 10 V
Type	NPN-Transistor, Switching frequency 5 kHz
Rated switching voltage	24 VDC ±30%
Rated switching current	100 mA
<b>Output (analogue)</b>	
Type (analogue output)	Voltage and current output (configurable)
Output voltage	0...5 V, 0...5 V, 0...10 V, -5...+5 V, -10...+10 V
Output current	-20...+20 mA, ± 10mA, 0...20 mA
<b>General data</b>	
Configuration	with push-buttons and display
Accuracy	< ±0.1 % of span
Step response time	2- / 4- wire: 320 ms., 3- wire / Poti: 640 ms
Temperature coefficient	≤ 0.02 % / °C, ≤ 200 ppm/K
Supply voltage	24...230 V DC ±15%, 24...230 V AC ±15% @48...62 Hz
Power consumption	≤ 2.6 W
<b>Insulation coordination</b>	
EMC standards	EN 61326-1
Standards	EN 61010-1
Insulation voltage	4 kV <sub>eff</sub> / 1 min.
Rated voltage	600 V
Impulse withstand voltage	5 kV (1.2/50 μs)
Pollution degree	2
Overvoltage category	II

<b>Dimensions</b>		<b>Pluggable screw connection</b>
Clamping range (nominal / min. / max.)	mm <sup>2</sup>	2.5 / 0.5 / 2.5
Depth / Width / Height	mm	113.7 / 12.5 / 117.2
<b>Note</b>		

**Ordering data**

<b>Channel</b>		<b>Type</b>	<b>Qty.</b>	<b>Order No.</b>
	PUSH IN connection	ACT20P-PRO-RTCI-AO-DO-P	1	2448110000
	Screw connection	ACT20P-PRO-RTCI-AO-DO-S	1	2448100000

<b>Note</b>	
-------------	--

**Accessories**

<b>Note</b>	
-------------	--

## DC isolating amplifier

- Isolation of DC signals
- Passive 3-wire transmitter and active current input
- 3-way isolation
- Removable terminals

## ACT20P-CI-V0

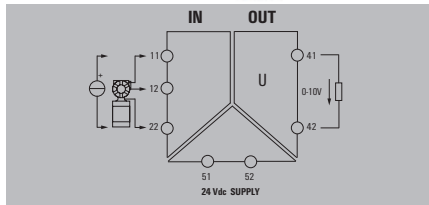

### Technical data

#### Input

Number of inputs  
Input signal  
Input current  
Sensor supply

#### Output

Number of outputs  
Output voltage  
load impedance voltage

#### General data

Step response time  
Current consumption  
Configuration  
Accuracy  
Temperature coefficient  
Supply voltage

#### Insulation coordination

Insulation voltage  
Impulse withstand voltage  
EMC standards  
Standards  
Test voltage  
Pollution degree  
Overvoltage category

Number of inputs	1
Input signal	2-/3-wire transmitter, Current source
Input current	0...20 mA, 4...20mA
Sensor supply	> 17 V DC at 20 mA
Number of outputs	1
Output voltage	0...10 V, 2...10 V
load impedance voltage	≥ 500 kΩ
Step response time	≤ 0,5 ms
Current consumption	≤60 mA (24V power supply, 20mA output)
Configuration	none
Accuracy	±0,1 % FSR max., 0,05 % FSR typ.
Temperature coefficient	80 ppm/K
Supply voltage	20...30 V DC
Insulation voltage	2 kV (Input /Output), 1 min, 50 Hz
Impulse withstand voltage	4 kV (1.2/50 μs)
EMC standards	EN 61326-1
Standards	EN 61010-1, UL 61010-1
Test voltage	300 V
Pollution degree	2
Overvoltage category	III

#### Dimensions

Clamping range (nominal / min. / max.) mm<sup>2</sup>  
Depth / Width / Height mm

0.6 / 0.5 / 2.5  
113.7 / 12.5 / 117.2

#### Note

### Ordering data

Type	Qty.	Order No.
ACT20P-CI-V0	1	1540010000

#### Note

### Accessories

#### Note



**Voltage converter, output loop powered**

- Removable terminals
- Power supply via the output circuit (output loop powered)
- 2-way isolation

**ACT20P-VI-CO-OLP**

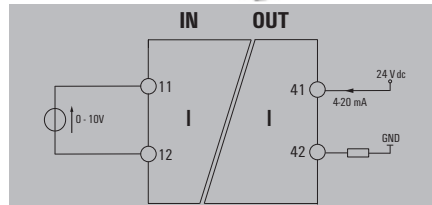

**Technical data**

<b>Input</b>	
Number of inputs	1
Input voltage	0...10 V 0...5 V DC
Input resistance, voltage	≥ 300 kΩ
<b>Output</b>	
Number of outputs	1
Output current	4...20 mA, loop-powered
load impedance current	≤ 600 Ω
<b>General data</b>	
Configuration	none
Galvanic isolation	2-way isolator
Accuracy	< 0.2 % of end value
Temperature coefficient	≤ 100 ppm/K
Supply voltage	via output current loop, min. 12 V DC/ max. 30 V DC
<b>Insulation coordination</b>	
EMC standards	EN 61010-1:2011, UL 61010-1, IEC61000-6-2, IEC 61000-6-4
Rated voltage	300 V
Insulation voltage	2 kV (Input /Output), 1 min, 50 Hz
Impulse withstand voltage	4 kV (1.2/50 μs)
Overvoltage category	III

<b>Dimensions</b>				
Clamping range (nominal / min. / max.)	mm <sup>2</sup>	2.5 / 0.5 / 2.5		
Depth / Width / Height	mm	114 / 12.5 / 117.2		
<b>Note</b>				
<b>Ordering data</b>				
Input voltage	0...10 V	Type	Qty.	Order No.
	0...5 V	ACT20P-VI-CO-OLP	1	7760054121
		ACT20P-VI1-CO-OLP	1	7760054120
<b>Note</b>				
<b>Accessories</b>				
<b>Note</b>				

<b>Pluggable screw connection</b>		
2.5 / 0.5 / 2.5		
114 / 12.5 / 117.2		
<b>Note</b>		

<b>Ordering data</b>				
Input voltage	0...10 V	Type	Qty.	Order No.
	0...5 V	ACT20P-VI-CO-OLP	1	7760054121
		ACT20P-VI1-CO-OLP	1	7760054120
<b>Note</b>				

<b>Accessories</b>				
<b>Note</b>				

## Current transformer signal splitter, output loop powered

- Isolation and splitting of DC signals
- Passive input
- Power supply via the output circuit (output loop powered)
- 2-way isolation

### ACT20P-CI-2CO-OLP

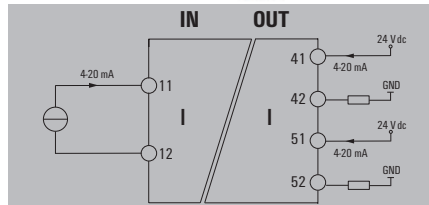

#### Technical data

##### Input

Number of inputs  
Input current  
Sensor

##### Output

Number of outputs  
Output current  
load impedance current

##### General data

Configuration  
Galvanic isolation  
Accuracy  
Temperature coefficient  
Supply voltage

##### Insulation coordination

EMC standards  
Insulation voltage  
Rated voltage  
Impulse withstand voltage  
Pollution degree  
Overvoltage category

1

4...20mA

Current source

2

4...20 mA, loop-powered

$R_L = (U_B - 12 \text{ V}) / 20 \text{ mA}$  z.B.  $600 \Omega$  at 24 V

none

2-way isolator

< 0.1 % of end value

≤ 100 ppm/K

via output current loop, min. 12 V DC/ max. 30 V DC

EN 61010-1:2011, UL 61010-1, IEC61000-6-2, IEC 61000-6-4

2 kV (Input /Output), 1 min, 50 Hz

300 V

4 kV (1.2/50 μs)

2

III

#### Dimensions

Clamping range (nominal / min. / max.) mm<sup>2</sup>  
Depth / Width / Height mm

#### Note

#### Pluggable screw connection

2.5 / 0.5 / 2.5  
114 / 12.5 / 117.2

#### Ordering data

Type	Qty.	Order No.
ACT20P-CI-2CO-OLP	1	7760054122

#### Note

#### Accessories

##### Note



Technical data

Machinery

Process

Energy

Transportation

Device Manufacturers

Infrastructure

**Current transformer, output loop powered**

- Isolation of DC signals
- Power supply via the output circuit (output loop powered)
- 2-way isolation
- Removable terminals

**ACT20P-CI-CO-OLP**

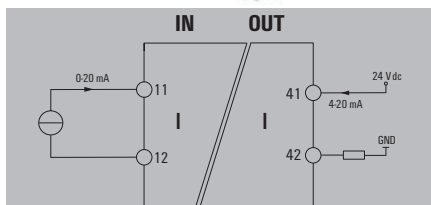

**Technical data**

Input	
Number of inputs	1
Input current	0...20 mA 4...20mA
Sensor	Current source
Output	
Number of outputs	1
Output current	4...20 mA, loop-powered
load impedance current	≤ 600 Ω
General data	
Galvanic isolation	2-way isolator
Accuracy	< 0.1 % of end value
Temperature coefficient	≤ 100 ppm/K
Supply voltage	via output current loop, min. 12 V DC/ max. 30 V DC
Insulation coordination	
EMC standards	EN 61010-1:2011, UL 61010-1, IEC61000-6-2, IEC 61000-6-4
Insulation voltage	2 kV inputs / outputs
Rated voltage	300 V
Impulse withstand voltage	4 kV (1.2/50 μs)
Pollution degree	2
Overtoltage category	III

Dimensions			
Clamping range (nominal / min. / max.)	mm <sup>2</sup>		
Depth / Width / Height	mm		
Note			
Pluggable screw connection			
2.5 / 0.5 / 2.5			
114 / 12.5 / 117.2			
Note			
Ordering data			
Input current	Type	Qty.	Order No.
0...20 mA	ACT20P-CI1-CO-OLP	1	7760054118
4...20 mA	ACT20P-CI2-CO-OLP	1	7760054119
Note			
Accessories			
Note			

Dimensions	
Clamping range (nominal / min. / max.)	mm <sup>2</sup>
Depth / Width / Height	mm
Note	

Pluggable screw connection		
2.5 / 0.5 / 2.5		
114 / 12.5 / 117.2		
Note		

Ordering data			
Input current	Type	Qty.	Order No.
0...20 mA	ACT20P-CI1-CO-OLP	1	7760054118
4...20 mA	ACT20P-CI2-CO-OLP	1	7760054119
Note			

Type	Qty.	Order No.
ACT20P-CI1-CO-OLP	1	7760054118
ACT20P-CI2-CO-OLP	1	7760054119

Accessories		
Note		



**Current transformer, input loop powered**

- Isolation of DC- signals
- Power supply via the input circuit (input loop powered)
- 1 or 2 channels in one module
- 2-way isolation
- Removable terminals

**ACT20P-CI-CO-ILP**

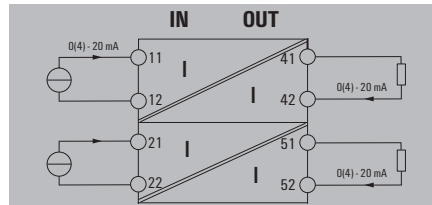

**Technical data**

Input	
Number of inputs	2
Input current	0...20 mA current loop
Sensor	Current source
Voltage drop, current input	3.8 V
Output	
Number of outputs	2
Output current	0...20 mA
load impedance current	≤ 600 Ω
General data	
Galvanic isolation	2-way isolator
Accuracy	< 0.1 % of end value
Temperature coefficient	≤ 100 ppm/K
Supply voltage	Loop powered, via 4...20 mA input
Insulation coordination	
EMC standards	EN 61010-1:2011, UL 61010-1, IEC61000-6-2, IEC 61000-6-4
Insulation voltage	2 kV inputs / outputs
Rated voltage	300 V
Impulse withstand voltage	4 kV (1.2/50 μs)
Pollution degree	2
Overvoltage category	III

Pluggable screw connection		
Clamping range (nominal / min. / max.)	mm <sup>2</sup>	2.5 / 0.5 / 2.5
Depth / Width / Height	mm	114 / 12.5 / 117.2
Note		

Dimensions		
Clamping range (nominal / min. / max.)	mm <sup>2</sup>	2.5 / 0.5 / 2.5
Depth / Width / Height	mm	114 / 12.5 / 117.2
Note		

Pluggable screw connection		
Clamping range (nominal / min. / max.)	mm <sup>2</sup>	2.5 / 0.5 / 2.5
Depth / Width / Height	mm	114 / 12.5 / 117.2
Note		

**Ordering data**

Channel	
	2 channel
	1 channel
Note	

Type	Qty.	Order No.
ACT20P-2CI-2CO-ILP	1	7760054124
ACT20P-CI-CO-ILP	1	7760054123

Note	

**Accessories**

Note	

Technical data

Machinery

Process

Energy

Transportation

Device Manufacturers

Infrastructure

**Voltage monitoring, 1-phase**

- Monitoring of single-phase systems up to 400 V AC/DC
- 3 input ranges can be selected
- 2 relays with CO contacts
- Holding function can be activated
- Rotary switch for setting limit values

**ACT20P-VMR-1PH-H**

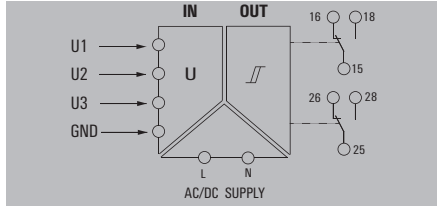

**Technical data**

Input	
Number of inputs	1
Input voltage	Channel 1: (U1-E): 110V AC/DC, Channel 2: (U2-E): 240V AC/DC, Channel 3 1: (U3-E): 400V AC/DC
Input measurement range	50...120% $U_{\text{rated voltage}}$
Input frequency	40...60 Hz, DC
Input resistance, voltage	1 M $\Omega$ ±5%
Output (digital)	
Number of digital outputs	2
Type	2 x 1 - or 1 x 2 changeover contact relay, Relay polarity can be inverted
Alarm function	Surge voltage, Undervoltage, Voltage window, Holding function can be activated, Alarm delay: 0...10 s
Rated switching current	5 A
Max. switching voltage, AC	250 V
Max. switching voltage, DC	30 V
General data	
Configuration	DIP switch and potentiometer
Accuracy	3% * $U_{\text{rated voltage}}$
Measurement calibration	max: 70...120% * $U_{\text{rated voltage}}$ , min: 50...100% * $U_{\text{rated voltage}}$
Power consumption	≤ 100 mA @ 24 VDC, ≤ 120mA @ 24V AC
Step response time	< 220 ms (10...90 %)
Temperature coefficient	350 ppm/K
Repeat accuracy	2% * $U_{\text{rated voltage}}$
Supply voltage	24...240 VUC ±10%
Insulation coordination	
EMC standards	IEC 61326-1
Galvanic isolation	3-way isolator, between input / output / supply
Rated voltage	300 VAC (output 1 - output 2), 300 VAC (supply-output), 500 VAC (supply-input, input-output)
Insulation voltage	2.5 kV (input / output), 2 kV input / output/ power supply
Impulse withstand voltage	Supply/output: 4 kV; input/output, supply/input: 6 kV, 1.2/50 $\mu$ s
Pollution degree	2
Overvoltage category	III
Standards	EN 50178
Dimensions	
Clamping range (nominal / min. / max.)	1.5 / 0.5 / 2.5
Depth / Width / Height	114.3 / 22.5 / 117
Note	

Type	Qty.	Order No.
ACT20P-VMR-1PH-H	1	7760054164

**Ordering data**

Note	
------	--

**Accessories**

Note	
------	--

### Voltage monitoring, 3-phase

- Voltage monitoring for 3-phase systems up to 500 V AC
- Phase monitoring
- 2 relays with CO contacts
- Holding function can be activated
- Rotary switch for setting limit values

### ACT20P-VMR-3PH-ILP-H

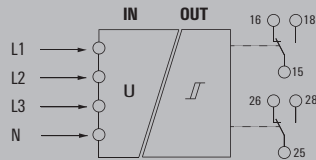

#### Technical data

Input	
Number of inputs	1
Input frequency	40..60 Hz
Input measurement range	200...480 VAC
Input voltage	180...500 VAC
Input resistance, voltage	≥1,8MΩ

Output (digital)	
Number of digital outputs	2
Type	2 x 1 - or 1 x 2 changeover contact relay
Alarm function	Top and bottom limit values, window range, Holding function can be activated, Phase error, Phase sequence, Asymmetry, Alarm delay: 0...10 s

Rated switching current	5 A
Max. switching voltage, AC	250 V
Max. switching voltage, DC	30 V

General data	
Configuration	DIP switch and potentiometer
Accuracy	3% *U <sub>rated voltage</sub>
Measurement calibration	max: 70...120% *U <sub>rated voltage</sub> , min: 50...100% *U <sub>rated voltage</sub>
Unbalanced	Hysteresis: 5%, Phase imbalance in range of adjustment: 5...25%, OFF
Repeat accuracy	2% *U <sub>rated voltage</sub>
Step response time	≤ 100 ms
Temperature coefficient	350 ppm/K
Supply voltage	supplied from voltage measurement inputs

Insulation coordination	
EMC standards	EN 61326-1
Galvanic isolation	2-way isolator, between input/output
Rated voltage	600 VAC (input - output), 300 VAC (output 1 - output 2)
Insulation voltage	2.5 kV (input / output)
Impulse withstand voltage	6 kV (input - output), 4 kV (output 1 - output 2), 1.2/50 μs
Pollution degree	2
Overvoltage category	III
Standards	EN 50178

Dimensions	
Clamping range (nominal / min. / max.)	mm <sup>2</sup>
Depth / Width / Height	mm

Note	

#### Ordering data

Pluggable screw connection		
	1.5 / 0.5 / 2.5	
	114.3 / 22.5 / 117	

Type	Qty.	Order No.
ACT20P-VMR-3PH-ILP-H	1	7760054165

Note	

#### Accessories

Note	

Technical data

Machinery

Process

Energy

Transportation

Device  
Manufacturers

Infrastructure

**Voltage measurement, 1-phase**

- Voltage monitoring of single-phase network up to 500 V AC
- 10 input ranges can be selected
- AC/DC power supply

**ACT20P-VM-A0-S**

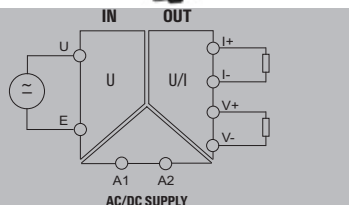

**Technical data**

**Input**

Number of inputs  
Input frequency  
Input voltage

**Output**

1  
40...60 Hz, DC  
 $U_{N1}$ : 0...300 V AC,  $U_{N2}$ : 0...125 V AC,  $U_{N3}$ : 0...60 VDC,  $U_{N4}$ : 0...150 VDC,  $U_{N5}$ : 0...300 V DC,  $U_{N6}$ : 0...30 V DC,  $U_{N7}$ : 0...300 VDC,  $U_{N8}$ : 0...440 VDC,  $U_{N9}$ : 0...60 VAC,  $U_{N10}$ : 0...144 VAC,  $U_{N11}$ : 0...300 VAC

Input resistance

1 MΩ±5%

**Output**

Number of outputs  
Output voltage  
Output current  
load impedance voltage  
load impedance current

1  
0...10 V  
0...20 mA  
≥ 10 kΩ  
≤ 500 Ω

**General data**

Configuration  
Accuracy  
Power consumption  
Step response time  
Temperature coefficient  
Supply voltage

With FDT/DTM software  
0.5 % FSR  
≤ 100 mA @ 24 VDC, ≤ 120mA @ 24V AC  
< 300 ms  
≤ 200 ppm/K  
24...240 VUC (±10%)

**Insulation coordination**

EMC standards  
Galvanic isolation  
Rated voltage  
Insulation voltage input or output/supply  
Impulse withstand voltage

IEC 61000-6 /2, IEC 61000-6-4, IEC 61326-1  
3-way isolator, between input / output / supply  
300 VAC (supply-output), 500 VAC (supply-input; input-output)  
2.2 kVAC, 1 min, 50 Hz  
4 kV (1.2 / 50 μs) input - output/ supply, 6 kV (input - output), 1.2/50 μs  
2  
III  
EN 50178

Pollution degree  
Overvoltage category  
Standards

**Dimensions**

Clamping range (nominal / min. / max.) mm<sup>2</sup>  
Depth / Width / Height mm

**Pluggable screw connection**

1.5 / 0.5 / 2.5  
114.3 / 22.5 / 117

**Note**

**Ordering data**

Type	Qty.	Order No.
ACT20P-VM-A0-S	1	7760054306

**Note**

**Accessories**

Note CBX 200

Technical data

Machinery

Process

Energy

Transportation

Device Manufacturers

Infrastructure

### Temperature monitoring

- Temperature monitoring of PT100 sensors or PTC
- Temperature range can be selected
- 2 relays with CO contacts
- Limit value can be set with software configuration

### ACT20P-TMR-RTI-S

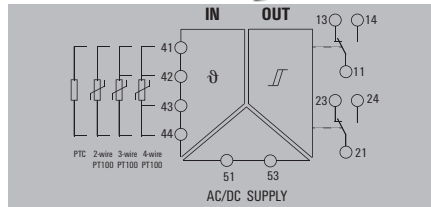

#### Technical data

<b>Input</b>		
Number of inputs	1	
Sensor	PT100 / 2-/3-/4-wire, PTC: 0...4 kΩ	
Temperature input range	Configurable, PT100: -200°C...850°C	
<b>Output (digital)</b>		
Number of outputs	2	
Type	2 x 1 - or 1 x 2 changeover contact relay	
Alarm function	Alarm range: -200...850 °C, Top and bottom limit values, window range, Hysteresis: 2 °C (adjustable), Alarm delay: 0...10 s	
Rated switching current	5 A	
Max. switching voltage, AC	250 V	
Max. switching voltage, DC	30 V	
<b>General data</b>		
Configuration	With FDT/DTM software	
Accuracy	0.2% FSR, ≤ 2 °C (PT100), ≤ 8 Ω (PTC)	
Power consumption	≤ 100 mA @ 24 VDC, ≤ 120mA @ 24V AC	
Step response time	≤ 500 ms	
Temperature coefficient	≤ 100 ppm/K	
Supply voltage	20...264 VUC	
<b>Insulation coordination</b>		
EMC standards	IEC 61326-1	
Galvanic isolation	3-way isolator, between input/output/supply	
Insulation voltage	2 kV (Input/Output), 1 min, 50 Hz	
Impulse withstand voltage	4 kV (1.2/50 μs)	
Pollution degree	2	
Overvoltage category	III	
Rated voltage	300 V	
Standards	IEC 61010-1	
<b>Dimensions</b>		
Clamping range (nominal / min. / max.)	mm <sup>2</sup> 1.5 / 0.5 / 2.5	
Depth / Width / Height	mm 114.3 / 22.5 / 117	
<b>Note</b>		
<b>Ordering data</b>		
<b>Type</b>	<b>Qty.</b>	<b>Order No.</b>
ACT20P-TMR-RTI-S	1	7760054305
<b>Note</b>		
<b>Accessories</b>		
<b>Note</b>	CBX 200	

Technical data

Machinery



Process



Energy



Transportation



Device Manufacturers



Infrastructure



Industry timing relay

- Multi-voltage input: 24 - 48 V DC, 24 - 240 V AC
- Space-saving construction
- 7 time functions with separate control input

ITS 24-240 V UC 1 CO M7C

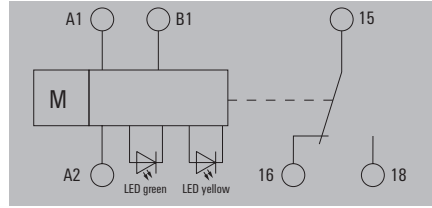
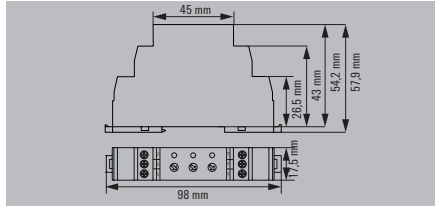

Technical data

Input	
Rated control voltage	24..48 V DC - 15 % / + 10 % / 24..240 V AC - 15 % / + 10 %
Power rating	8 VA @ 230 V AC, 0.4 W at 24 V DC
Status indicator	LED green (U/t): flashes when time runs, lights permanently with supply voltage applied, LED yellow (R): relay closed
Repeat accuracy	< 0.5 % or ±5 ms
Basic accuracy	< 1.5 % (of scale-end value)
Setting tolerance	5 %
Min. pulse duration	50 ms
Time ranges	0.05 s - 1 s, 0.5 s - 10 s, 3 s - 60 s, 0.5 min - 10 min, 3 min - 1 h, 0.5 h - 10 h
Max. reset time after voltage interruption	100 ms
Output	
Rated switching voltage	250 V AC
Max. switching voltage, AC	250 V
Max. switching voltage, DC	30 V
Continuous current	5 A
AC switching capacity (resistive), max.	1250 VA
DC switching capacity (resistive), max.	90 W
Max. switching frequency at rated load	0.1 Hz
Contact material	AgNi
Mechanical service life	1 x 10 <sup>6</sup> switching cycles
General data	
Ambient temperature (operational)	-25 °C...50 °C
Storage temperature	-40 °C...70 °C
Humidity	25 - 75%, no condensation
Version	with separate control input
Resistance to vibration EN 61812-1	10 Hz...60 Hz: 0.15 mm, 60 Hz...150 Hz: 2 g
Approvals	CE
Insulation coordination	
Rated voltage	300 V
Creepage and clearance distance input - output	≥ 1.5 mm
Dielectric strength input - output	1.6 kV
Impulse withstand voltage	2.5 kV
Protection degree	IP20
Dimensions	
Clamping range (nominal / min. / max.)	mm <sup>2</sup> 2.5 / 0.25 / 2.5
Depth x width x height	mm 57.9 / 17.5 / 98
Note	

Ordering data

ITS 24-240VUC 1CO M7C	Screw connection
-----------------------	------------------

Note	
------	--

Accessories

Note	
------	--

Type	Qty.	Order No.
ITS 24-240VUC 1CO M7C	1	2496190000

Time functions

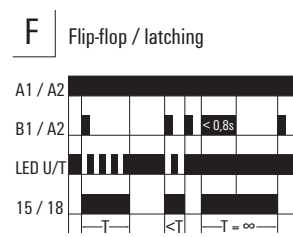
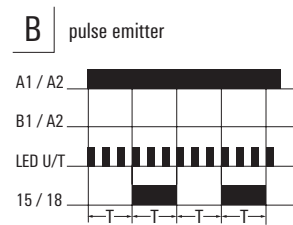
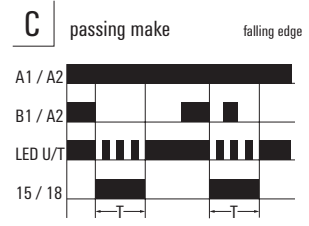
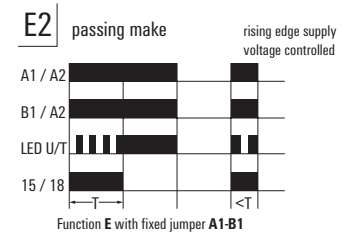
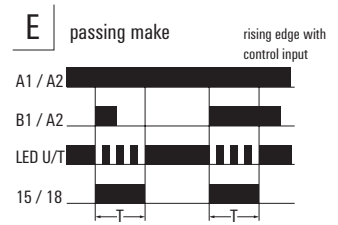
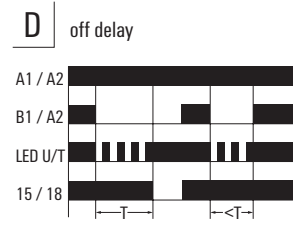
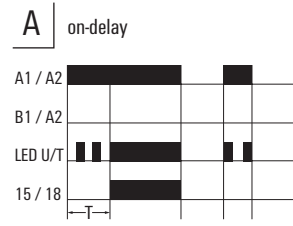



Infrastructure



Device  
Manufacturers



Transportation



Energy



Process



Machinery

Technical data

**PUSH IN connection system**

- Proven PUSH IN connection system with WireReady
- The integrated, captive coding with „AutoSet“ function protects against false insertion
- Tool-free fast connector mounting
- Safe interlocking and unlocking through release lever
- Connection system for devices from the series: ACT20P, ACT20C, ACT20X

**CH20M BHF 5.00**

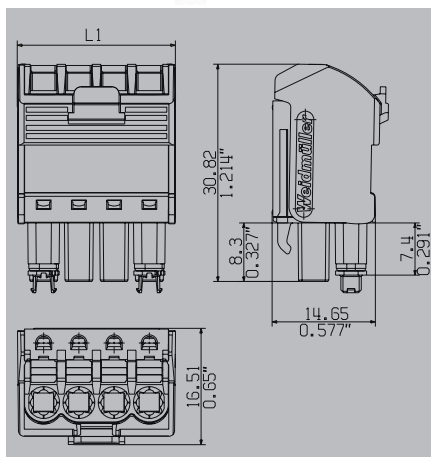

**Technical data**

Wire connection method	PUSH IN
Pitch, in mm	5.00 mm
Number of rows	1
Can be coded	Yes
Stripping length	8 mm
Insulating material	PA 66 GF 30
Colour	Black
Insulating material group	II
Contact surface	tinned
Wire connection cross section AWG, min.	AWG 26
Wire connection cross section AWG, max.	AWG 14
w. wire end ferrule, DIN 46228 pt 1, min	0.25 mm <sup>2</sup>
w. wire end ferrule, DIN 46228 pt 1, max.	2.5 mm <sup>2</sup>
Rated voltage (Use group B)	300 V
Rated current (use group B)	10 A

**Note**

**Ordering data**

Release lever black	Type	Qty.	Order No.
2 pole	BHF 5.00/02/180LH BK/BK	150	1497740000
3 pole	BHF 5.00/03/180LH BK/BK	108	1497670000
4 pole	BHF 5.00/04/180LH BK/BK	78	1497500000
Release lever orange	BHF 5.00/02/180LH BK/OR	150	1988380000
3 pole	BHF 5.00/03/180LH BK/OR	108	1989210000
4 pole	BHF 5.00/04/180LH BK/OR	78	1989190000
Release lever blue	BHF 5.00/02/180LH BK/BL	150	1989220000
3 pole	BHF 5.00/03/180LH BK/BL	108	1989200000
4 pole	BHF 5.00/04/180LH BK/BL	78	1989090000

**Note**

**Accessories**

**Note**

Technical data

Machinery

Process

Energy

Transportation

Device Manufacturers

Infrastructure





Infrastructure



Device  
Manufacturers



Transportation



Energy



Process



Machinery

Technical data

**Type II N-PE arrester**

- Tested according to IEC 61643-11 Type II
- Pluggable N-PE arrester
- Coded voltage level
- High energy absorption with short time to sparkover
- Insert can be rotated through 180°
- Installation in distribution board

**VPU II 1 N-PE 260 40/65**

**N-PE arrester 260 V**

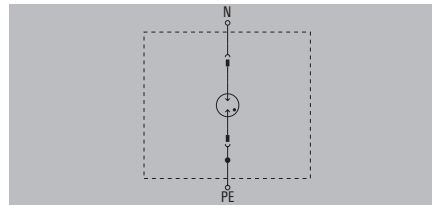

**Technical data**

Rated voltage (AC)	230 V
Max. continuous voltage, U <sub>c</sub> (AC)	260 V
Max. continuous voltage, U <sub>c</sub> (N-PE)	260 V
Discharge current I <sub>n</sub> (8/20µs) wire-PE	40 kA
Discharge current I <sub>n</sub> (8/20µs) N-PE	40 kA
Discharge current I <sub>max</sub> (8/20µs) wire-PE	65 kA
Discharge current I <sub>max</sub> (8/20µs) N-PE	65 kA
Combined pulse U <sub>dc</sub>	10 kV
Requirements class, acc. to EN 61643-11	T2, T3
Short-circuit current rating I <sub>scCR</sub>	100 kA
Leakage current at U <sub>n</sub>	0 µA
Fuse	
Temporary surge voltage (over-voltage) - TOV	1200 V
Protection level U <sub>p</sub> at I <sub>n</sub> (L/N-PE)	≤ 1.6 kV
Protection level U <sub>p</sub> at I <sub>n</sub> (N-PE)	≤ 100 ns
Response time	≤ 100 ns
Optical function display	No
Design	Installation housing: 1TE, Insta IP 20
Colour	Black, arrester blue
Ambient temperature (operational)	-40 °C...70 °C
Storage temperature	-40 °C...80 °C
<b>Connection according to IEC 947-7-1</b>	
Solid	1.5...16 mm <sup>2</sup>
Stranded	1.5...50 mm <sup>2</sup>
Stripping length	15 mm
Tightening torque	2...3 Nm
<b>Approvals</b>	
Approvals	CE
Standards	IEC61643-11, EN61643-11

**Dimensions / Signalling contact info**

Clamping range (nominal / min. / max.)	mm <sup>2</sup>	16 / 1.5
Height x width x depth	mm	94 / 17.8 / 69
Signalling contact		No

<b>Note</b>	no remote sig. contact
-------------	------------------------

**Ordering data**

	without remote signalling contact	
<b>Type</b>	<b>Qty.</b>	<b>Order No.</b>
VPU II 1 N-PE 260 40/65	1	2520470000

<b>Note</b>	
-------------	--

**Accessories**

<b>Note</b>	Pluggable spare arrester VPU II 0 N-PE 260 40/64 - 2520890000
-------------	---

Technical data

Machinery

Process

Energy

Transportation

Device Manufacturers

Infrastructure

**Type II/III surge protection  $U_c$ : 280 V**  
**Suitable for 230/400 V mains systems**

- Pluggable arrester
- Coded voltage level
- High energy absorption with short time to sparkover
- Insert can be rotated through 180°
- No follow-on current
- Installation in distribution board
- Thermal protection function
- Co-ordination with VPU Type I

**VPU II 1+1/R 280 40/65**

1-phase

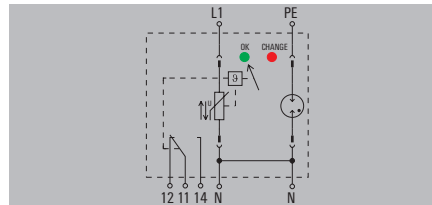

**VPU II 3+1/R 280 40/65**

TN-S, TT

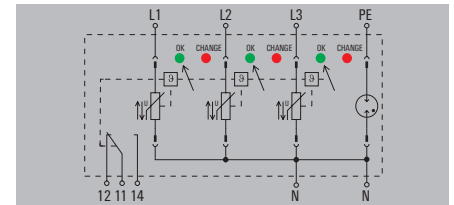

**Technical data**

Rated voltage (AC)  
 Max. continuous voltage,  $U_c$  (AC)  
 Max. continuous voltage,  $U_c$  (N-PE)  
 Discharge current  $I_n$  (8/20 $\mu$ s) wire-PE  
 Discharge current  $I_n$  (8/20 $\mu$ s) N-PE  
 Discharge current  $I_{nmax}$  (8/20 $\mu$ s) wire-PE  
 Discharge current  $I_{nmax}$  (8/20 $\mu$ s) N-PE  
 Combined pulse  $U_{oc}$   
 Requirements class, acc. to EN 61643-11  
 Short-circuit current rating  $I_{scorr}$   
 Leakage current at  $U_n$   
 Fuse  
 Temporary surge voltage (over-voltage) - TOV  
 Protection level  $U_p$  at  $I_n$  (L/N-PE)  
 Protection level  $U_p$  at  $I_n$  (N-PE)  
 Response time  
 Optical function display  
 Design  
 Colour  
 Ambient temperature (operational)  
 Storage temperature

**Connection according to IEC 947-7-1**

Solid  
 Stranded  
 Stripping length  
 Tightening torque

**Approvals**

Approvals  
 Standards

**Dimensions / Signalling contact info**

Clamping range (nominal / min. / max.) mm<sup>2</sup>  
 Height x width x depth mm  
 Signalling contact

**Note**

**Ordering data**

without remote signalling contact  
 with remote signalling contact (R)

**Note**

**Accessories**

**Note**

230 V  
 280 V  
 260 V  
 20 kA  
 40 kA  
 40 kA  
 65 kA  
 10 kV  
 T2, T3  
 25 kA  
 100  $\mu$ A  
 125 A gL (if back-up fuse > 125 A)  
 438 V  
 $\leq 1.55$  kV  
 $\leq 1.6$  kV  
 $\leq 25$  ns,  $\leq 100$  ns  
 green = OK; red = arrester is defective - replace  
 Installation housing; 2TE, Insta IP 20  
 Black, Arrester orange / blue  
 -40 °C...70 °C  
 -40 °C...80 °C

1.5...16 mm<sup>2</sup>  
 1.5...50 mm<sup>2</sup>  
 15 mm  
 2...3 Nm

CE  
 IEC61643-11, EN61643-11

**no remote sig. contact      with remote signalling (R)**

16 / 1.5      16 / 1.5  
 94 / 35.6 / 69      106 / 35.6 / 69  
 No      250 V 1A 1CO

Type	Qty.	Order No.
VPU II 1+1 280 40/65	1	2520900000
VPU II 1+1 R 280 40/65	1	2520910000

Pluggable spare arrester L-N VPU II 0 280 V/40 kA - 1352570000,  
 N-PE VPU II 0 N-PE 260 40/65 - 2520890000

230 V  
 280 V  
 260 V  
 20 kA  
 40 kA  
 40 kA  
 65 kA  
 10 kV  
 T2, T3  
 25 kA  
 100  $\mu$ A  
 125 A gL (if back-up fuse > 125 A)  
 438 V  
 $\leq 1.55$  kV  
 $\leq 1.6$  kV  
 $\leq 25$  ns,  $\leq 100$  ns  
 green = OK; red = arrester is defective - replace  
 Installation housing; 4TE, Insta IP 20  
 Black, Arrester orange / blue  
 -40 °C...70 °C  
 -40 °C...80 °C

1.5...16 mm<sup>2</sup>  
 1.5...50 mm<sup>2</sup>  
 15 mm  
 2...3 Nm

CE  
 IEC61643-11, EN61643-11

**no remote sig. contact      with remote signalling (R)**

16 / 1.5      16 / 1.5  
 94 / 71.2 / 69      106 / 71.2 / 69  
 No      250 V 1A 1CO

Type	Qty.	Order No.
VPU II 3+1 280 40/65	1	2520920000
VPU II 3+1 R 280 40/65	1	2520930000

Pluggable spare arrester L-N VPU II 0 280 V/40 kA - 1352570000,  
 N-PE VPU II 0 N-PE 260 40/65 - 2520890000

### Graphically programmable logic units

- For simple instrumentation and control tasks
- Digital and analogue inputs
- Digital outputs + PWM output
- Suitable for high temperature and vibration requirements

### Logit unit WCU 501



### Logit unit WCU 650



#### Technical data

General data	
Type of connection / Wire connection method	Plug-in spring-type terminals (0.25 - 1.5 mm <sup>2</sup> ) / PUSH IN
Operating voltage	+VDD: 7...32 V DC
Input fuse	max. 8 A (external)
Optical function display	LED
Interface	Seriell RS232
Protection degree	IP20
Encapsulation compound	Polyurethane (PU)
Analogue inputs	
Number	3
Pin assignment	IN 3, IN 4, IN 5
Resolution	10 Bit
Input voltage (U <sub>in</sub> )	0...30 V DC
Precision	± 3 % (0.5 V DC)
Digital inputs	
Number	2
Pin assignment	IN 1, IN 2
Input frequency (f <sub>in</sub> )	≤ 1 kHz
Input voltage (U <sub>in</sub> )	0...30 V DC
Digital outputs	
Number	4
Pin assignment	OUT 1, OUT 2, OUT 3, OUT 4
Total output current (I <sub>OUT</sub> ) / Output current per channel (I <sub>OUT</sub> )	≤ 4 A / < 1.5 A
Switching frequency (f <sub>OUT</sub> )	0...100 Hz
PWM output	
Number of	1
Pin assignment	OUT 5
Output current per channel (I <sub>OUT</sub> )	≤ 1 A
Note	Can also be used as a digital output (ground-switching)
Switching frequency (f <sub>OUT</sub> )	1...10 kHz
Type	Ground switching
Temperatures	
Ambient temperature (operational) / Storage temperature	-40 °C...70 °C / -40 °C...70 °C
EMC / shock / vibration	
EMC interference resistance	EN 61000-6-2:2005
Shock resistance	min. 100 m/s <sup>2</sup> (10 g)
Vibration resistance	min. 50 m/s <sup>2</sup> (5 g) @ 9...200 Hz
CAN interface	
Bus system	
Baud rate	
Identifier	

General data		
Type of connection / Wire connection method	Plug-in spring-type terminals (0.25 - 1.5 mm <sup>2</sup> ) / PUSH IN	
Operating voltage	+VDD: 7...32 V DC	
Input fuse	max. 8 A (external)	
Optical function display	LED	
Interface	Seriell RS232	
Protection degree	IP20	
Encapsulation compound	Polyurethane (PU)	
Analogue inputs		
Number	6	
Pin assignment	IN 1, IN 2, IN 3, IN 4, IN 5, IN 6	
Resolution	12-bit	
Input voltage (U <sub>in</sub> )	0...30 V DC	
Precision	± 2% (0.25 V DC)	
Digital inputs		
Number	4	
Pin assignment	IN 7, IN 8, IN 9, IN 10	
Input frequency (f <sub>in</sub> )	≤ 1 kHz	
Input voltage (U <sub>in</sub> )	0...30 V DC	
Digital outputs		
Number	8	
Pin assignment	OUT 1, OUT 2, OUT 3, OUT 4, OUT 5, OUT 6, OUT 7, OUT 8	
Total output current (I <sub>OUT</sub> ) / Output current per channel (I <sub>OUT</sub> )	≤ 6 A / ≤ 1.5 A	
Switching frequency (f <sub>OUT</sub> )	0...100 Hz	
PWM output		
Number of	1	
Pin assignment	OUT 9	
Output current per channel (I <sub>OUT</sub> )	≤ 1 A	
Note	Can also be used as a digital output (ground-switching)	
Switching frequency (f <sub>OUT</sub> )	1...10 kHz	
Type	Ground switching	
Temperatures		
Ambient temperature (operational) / Storage temperature	-40 °C...70 °C / -40 °C...70 °C	
EMC / shock / vibration		
EMC interference resistance	EN 61000-6-2:2005	
Shock resistance	min. 100 m/s <sup>2</sup> (10 g)	
Vibration resistance	min. 50 m/s <sup>2</sup> (5 g) @ 10...150 Hz	
CAN interface		
Bus system	ISO 11898-2, CAN 2.0B, CAN 2.0A	
Baud rate	100 kbit, 125 kbit, 250 kbit, 500 kbit	
Identifier	11bit / 29 bit	

Dimensions		
Depth x width x height	31 / 44 / 40	
Note		
Ordering data		
Type	Qty.	Order No.
graphically programmable logic module	1	1517130000
graphically programmable logic module, CAN interface		
Logic module incl. USB programming adapter	1	1548720000
Note		
You can download the software from the product catalogue on the Weidmüller website.		

Dimensions		
Depth x width x height	30 / 45 / 93	
Note		
Ordering data		
Type	Qty.	Order No.
LOGIC UNIT WCU 650	1	2010680000
STARTERKIT WCU 650	1	2007290000
Note		
You can download the software from the product catalogue on the Weidmüller website.		



Infrastructure



Device  
Manufacturers



Transportation



Energy



Process



Machinery

Technical data

Customer specific 1,500 V DC combiner boxes

Combiner boxes 1,500 V DC



Technical data

Inputs
Outputs
Current per string (A)
Rated voltage (V)
String inputs
Continuous operating temperature (°C)
Protection degree
Material
Switch disconnecter
Surge protection device
Surge protection on RS485
Power supply
Monitoring
Communication port
Communication protocol
Standards

8-32
1-2
≤ 25 A
≤ 1,500 V DC
Cable glands or WM4 C connector
-20 °C to +50 °C
IP55 or IP65 or IP66
GFRP
yes (optional)
Type I or Type I+II or Type II
yes (optional)
230 V AC / 24 V DC or 1,500 V DC / 24 V DC
yes (optional)
RS485
MODBUS/RTU
IEC 61439-2 ed 2.0 / EN 61439-2:2011

Technical data

Machinery

Process

Energy

Transportation

Device Manufacturers

Infrastructure

**WM4 C photovoltaik connector with crimp connection – Typ 4**
**Technical data**

	WM4 C field connector	BOX WM4 C housing connector
Continuous operating temperature	-40 °C to +85 °C	-40 °C to +85 °C
Protection class (plugged/open)	IP 65 & IP 67 / IP 2x	IP 65 & IP 67 / IP 2x
Rated current	35 A	35 A
Rated voltage	1.500V DC (IEC)	1.500V DC (IEC)
Cable diameter	4 mm <sup>2</sup> / 6 mm <sup>2</sup>	4 mm <sup>2</sup> / 6 mm <sup>2</sup>
Cable exterior diameter	5.5 ...7.0 mm	5.5 ...7.0 mm
Cable as per standard	2PG1169/08.07 & EN 50618:2014	2PG1169/08.07 & EN 50618:2014
Thread	M16	M12
Pollution degree	II	II
Approvals	TÜV (DIN EN 50521)	TÜV (DIN EN 50521)

**Ordering data**
**WM4 C field connector**

	Type	Qty.	Order No.
	BUGH WM4 C BT Female housing	100 (in bag)	1530690000

	Type	Qty.	Order No.
	SFGH WM4 C BT Male housing	100 (in bag)	1530700000

**BOX WM4 C housing connector**

	Type	Qty.	Order No.
	BUGH BOX WM4 C BT Female housing	100 (in bag)	1530630000

	Type	Qty.	Order No.
	SFGH BOX WM4 C BT Male housing	100 (in bag)	1530640000



**Crimp contacts**

	Type	Qty.	Order No.
	BUKO WM4 C BT Female contact	100 (in bag)	1530670000
	BUKO WM4 C RL Female contact	1,500 (on roll)	1530770000

	Type	Qty.	Order No.
	SFKO WM4 C BT Male contact	100 (in bag)	1530680000
	SFKO WM4 C RL Male contact	1,500 (on roll)	1530780000

**Accessories and related products**

	Type	Qty.	Order No.
	VSSO WM4 C Universal dust cap for male and female housings	100	1254870000
	PVC-TV1-BK-4-1000 4 mm <sup>2</sup>	1 km	1203780000
	PVC-TV1-BK-6-1000 6 mm <sup>2</sup>	1 km	1524740000
	multi-stripax® PV Wire stripping pliers for PV wires from 2.5 mm <sup>2</sup> to 6 mm <sup>2</sup>	1	1190490000
	KT 8 Cutting tool	1	9002650000

	Type	Qty.	Order No.
	CTF PV WM4 C Crimping tool	1	1222870000
	SCREWTY SW15 optional mounting tool for WM4 C	1	1290830000
	SCREWTY SW18 optional mounting tool for BOX WM4 C	1	1254670000
	DMS MANUELL 0,5-1,7 Nm	1	9918370000
	DMS MANUELL 2,0-8,0 Nm	1	9918380000

**Cable harnessing**

Individual types and cable length on request

Transclenic xi+

Transclenic 16i+ 1K5 L



Technical data

Machinery

Process

Energy

Transportation

Device Manufacturers

Infrastructure



Technical data

Maximum number of strings	16
Max. current per string	15 A DC (-25...+70 °C), 25 A DC (-25...+60°C)
Rated voltage	1500 V DC
String-current measurement error	± 300 mA from 3 A DC to 15 A DC
String-voltage measurement error	± 18 V from 150 V DC to 1,500 V
Communication	MODBUS RS485 RTU
Number of digital inputs	2
Elevation	≤ 2000 m
Ambient temperature	-25 °C...70 °C
Supply voltage	19,2 - 28,8 V DC

Dimensions

Length x width x height	mm	368.9 / 109.5 / 92.2
-------------------------	----	----------------------

Note

Ordering data

Type	Qty.	Order No.
TRANSLINIC 16i+ 1K5 L	1 ST	2433950000

Note

Accessories

Note	
------	--





Infrastructure



Device  
Manufacturers



Transportation



Energy



Process



Machinery

Technical data

**FAD – front adapters for migrations from Rockwell PLC5**

The FAD PLC5 front adapters with pre-assembled cables provide safe migration from the old PLC 5 to other PLC systems or to the u-remote system from Weidmüller.

- Clip-in foot for TS35

**FAD 1771-WA/WC/WB/WD**



**Technical data**

Rated data	
Operating voltage, max.	< 300 V AC
Max. current per channel	2 A
Total operating current	6 A
General data	
Ambient temperature (operational)	-25...50 °C
Storage temperature	-40...60 °C
Approvals	CE
Insulation coordination (EN 50178)	
Rated insulation voltage	< 300 V AC
Surge voltage category	II
Pollution severity level	2
Insulation test voltage	1.2 kVAC

< 300 V AC
2 A
6 A
-25...50 °C
-40...60 °C
CE
< 300 V AC
II
2
1.2 kVAC

Dimensions	
Length / Width	269 mm / 32 mm

269 mm / 32 mm
----------------

Note	

--

**Ordering data**

FAD for wiring-arm WA-WC	Type	Qty.	Order No.
FAD for wiring-arm WB-WD	FAD 1771-WA/WC BL10 M	1	2448650000
	FAD 1771-WB/WD BL12 M	1	2448680000

Type	Qty.	Order No.
FAD 1771-WA/WC BL10 M	1	2448650000
FAD 1771-WB/WD BL12 M	1	2448680000

Note	

--

**Accessories**

Note	

--

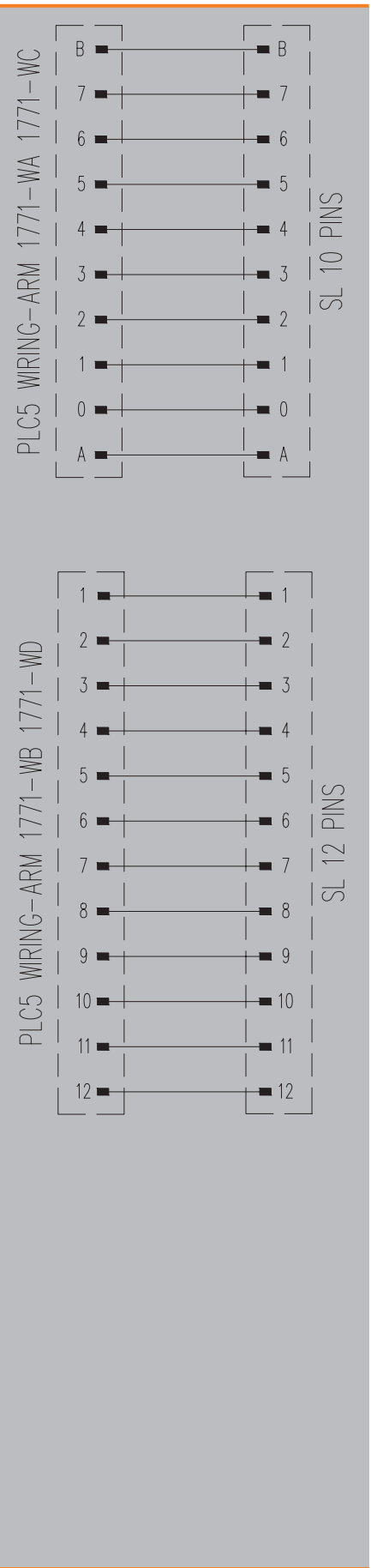

Technical data

Machinery

Process

Energy

Transportation

Device Manufacturers

Infrastructure

### FAD – front adapters for migrations from Rockwell PLC5

The FAD PLC5 front adapters with pre-assembled cables provide safe migration from the old PLC 5 to other PLC systems or to the u-remote system from Weidmüller.

- Clip-in foot for TS35

### FAD 1771-WF/WG/WH



#### Technical data

Rated data	
Operating voltage, max.	< 250 V AC
Max. current per channel	2 A
Total operating current	8 A
General data	
Ambient temperature (operational)	-25...50 °C
Storage temperature	-40...60 °C
Approvals	CE
Insulation coordination (EN 50178)	
Rated insulation voltage	< 250 V AC
Surge voltage category	II
Pollution severity level	2
Insulation test voltage	1.2 kVAC

< 250 V AC
2 A
8 A
-25...50 °C
-40...60 °C
CE
< 250 V AC
II
2
1.2 kVAC

Dimensions	
Length / Width	269 mm / 32 mm

269 mm / 32 mm
----------------

Note	

--	--

#### Ordering data

FAD for wiring-arm WH-WG	Type	Qty.	Order No.
FAD for wiring-arm WF	FAD 1771-WH/WG BL21 M	1	2448660000
	FAD 1771-WF BL18 M	1	2448690000

Type	Qty.	Order No.
FAD 1771-WH/WG BL21 M	1	2448660000
FAD 1771-WF BL18 M	1	2448690000

Note	

--	--

#### Accessories

Note	

--	--

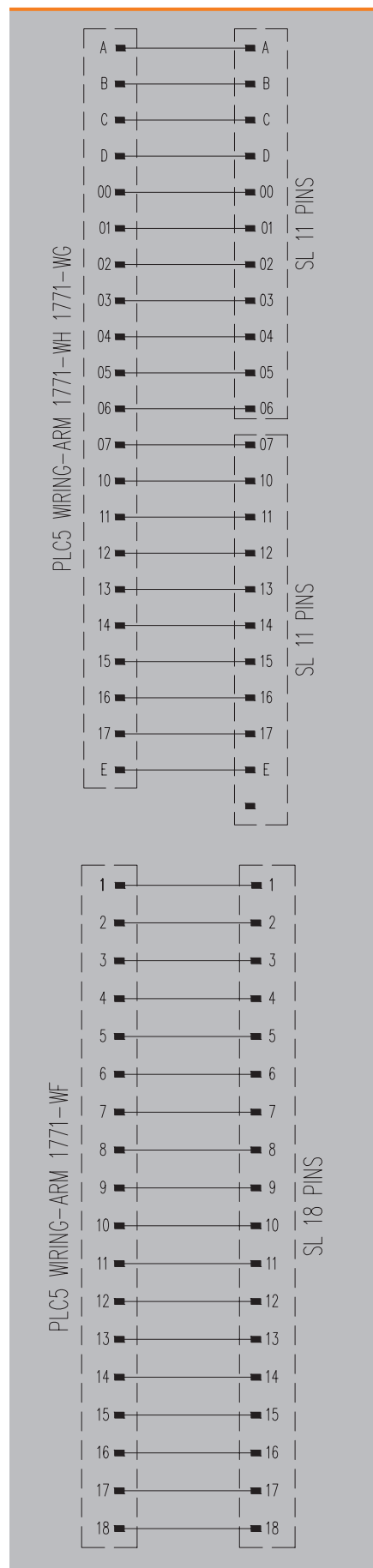

Technical data

Machinery

Process

Energy

Transportation

Device Manufacturers

Infrastructure

### FAD – front adapters for migrations from Rockwell PLC5

The FAD PLC5 front adapters with pre-assembled cables provide safe migration from the old PLC 5 to other PLC systems or to the u-remote system from Weidmüller.

- Clip-in foot for TS35

### FAD 1771-WN



#### Technical data

Rated data	
Operating voltage, max.	< 250 V AC
Max. current per channel	2 A
Total operating current	8 A
General data	
Ambient temperature (operational)	-25...50 °C
Storage temperature	-40...60 °C
Approvals	CE
Insulation coordination (EN 50178)	
Rated insulation voltage	< 250 V AC
Surge voltage category	II
Pollution severity level	2
Insulation test voltage	1.2 kVAC

Dimensions	
Length / Width	269 mm / 32 mm

Dimensions	
Length / Width	269 mm / 32 mm

Note	

#### Ordering data

FAD for wiring-arm WN
-----------------------

Type	Qty.	Order No.
FAD 1771-WN 2BL20 M	1	2448670000

Note	

#### Accessories

Note	

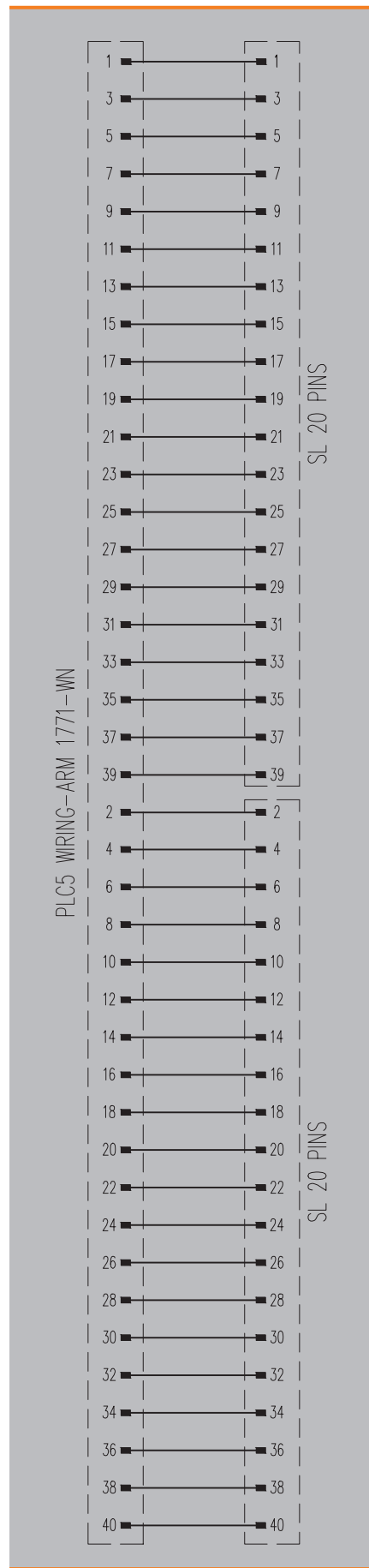

Technical data

Machinery

Process

Energy

Transportation

Device Manufacturers

Infrastructure



Infrastructure



Device  
Manufacturers



Transportation



Energy



Process



Machinery

Technical data

### Front panel adaptors for migrations from Honeywell IPC620

Feed through connections

- IPC-620 conversion to pluggable connector(s)
- 12-, 22-point cards

### IPC620 carrier



#### Technical data

Rated data	
Operating voltage	150 V
Max. current per channel	5 A
General data	
Ambient temperature (operational)	0...50 °C
Storage temperature	0...50 °C
Approvals	

Dimensions	
Length / Width / Height	266 mm / 29 mm / 61 mm

Note	

#### Ordering data

Type	Qty.	Order No.
12-point IPC-620 card adapter	1	<b>6720000787</b>
22-point IPC-620 card adapter	1	<b>6720000788</b>

Note	

#### Accessories

Note	

### 12-points IPC620 card adapter

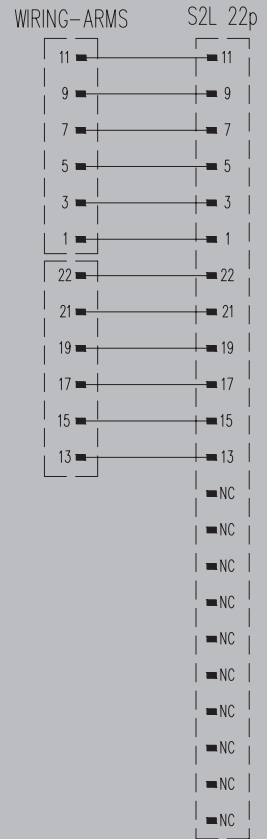

### 22-points IPC620 card adapter

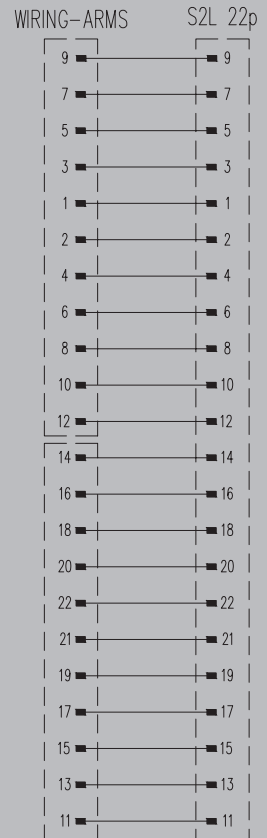

### Front panel adaptors for migrations from Honeywell IPC620

Feed through connections

- IPC-620 conversion to pluggable connector(s)
- 38-point cards

### IPC620 carrier



#### Technical data

Rated data	
Operating voltage	125 V
Max. current per channel	3 A
General data	
Ambient temperature (operational)	0...50 °C
Storage temperature	0...50 °C
Approvals	

125 V
3 A
0...50 °C
0...50 °C

#### Dimensions

Length / Width / Height

266 mm / 29 mm / 126 mm
-------------------------

#### Note

#### Ordering data

38-points (Reference Honeywell TB 621-9977 or -9976)
--

Type	Qty.	Order No.
38-point IPC-620 card adapter	1	6720001225

#### Note

#### Accessories

Note

#### WIRING-ARMS 2xSL 20p

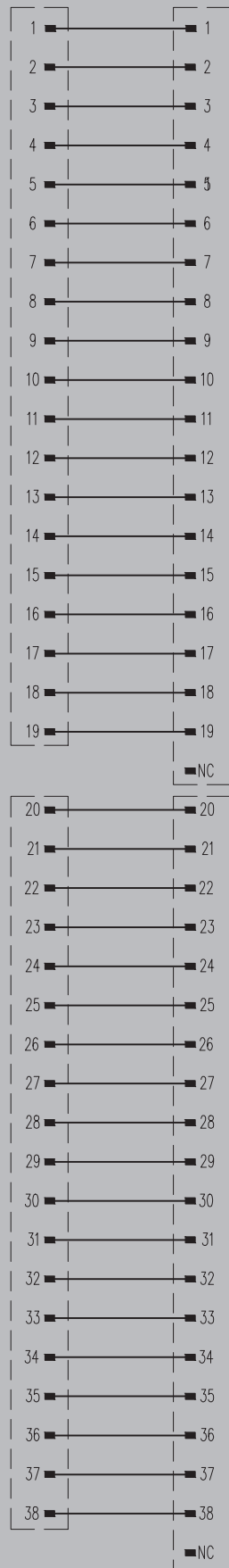

Technical data

Machinery



Process



Energy



Transportation



Device Manufacturers



Infrastructure



Technical data

Machinery

Process

Energy

Transportation

Device Manufacturers

Infrastructure

### Front panel adaptors for migrations from Honeywell IPC620

Feed through connections

- IPC-620 conversion to pluggable connector(s)
- 24-point cards

### IPC620 carrier



#### Technical data

Rated data	
Operating voltage	50 V
Max. current per channel	3 A
General data	
Ambient temperature (operational)	0...50 °C
Storage temperature	0...50 °C
Approvals	

Operating voltage	50 V
Max. current per channel	3 A
Ambient temperature (operational)	0...50 °C
Storage temperature	0...50 °C
Approvals	

#### Dimensions

Length / Width / Height	266 mm / 29 mm / 50 mm
-------------------------	------------------------

#### Note

#### Ordering data

Type	Qty.	Order No.
24-points (Reference Honeywell TB 621-9954)	1	6720001226

#### Note

#### Accessories

#### Note

WIRING-ARM

S2L 24p

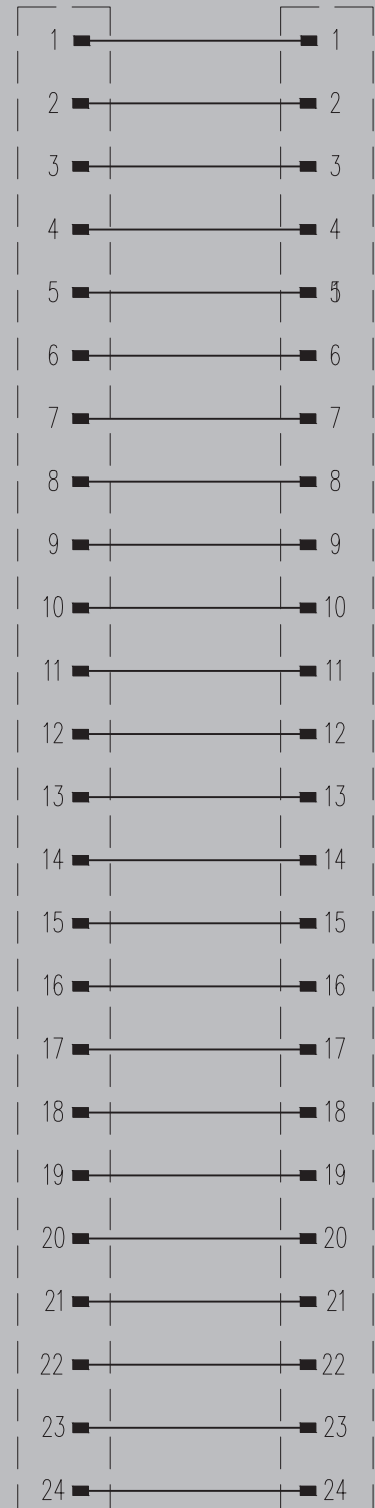





Infrastructure



Device  
Manufacturers



Transportation



Energy



Process



Machinery

Technical data

**Backplane with SIL 3 relays for Yokogawa Pro-safe SDV541**

- 2 AKB connectors (50 poles) for redundancy
- Green LED shows relays switching status
- Monotorization of the Power supply status with green LED and alarm contact (24 V DC / 2...100 mA): close contact and led shinning means no supply fault.
- 2 versions with De-energized to Safe SIL relays with and without monitoring
- Screw connection

**BKP-16DO-SDV541**



**Technical data**

<b>Connected to</b>	Connection to the card
<b>Connection data and functionality</b>	Connection on control side
	Relay type
	Power supply fuse
<b>Input (safety circuit)</b>	
	Rated control voltage
	Power consumption
	Guaranteed current consumption of 24 VDC -10%
	Status indicator
<b>Output (safety circuit)</b>	
	Base material of the contact / Contact design
	max. permitted switching voltage
	max. permitted switching current
	max. switching current, internal fuse
	max. switching current, external fuse
	Switching capacity min./max.
	Internal fuse
	Short-circuit-proof
	Switch-on time / Switch-off time
<b>General data</b>	
	Ambient temperature (operational)
	Storage temperature
<b>Insulation coordination (EN 50178)</b>	
	Rated input insulation voltage
	Rated output insulation voltage
	Overvoltage category input/output
	Overvoltage category input/input
	Overvoltage category output/output
	Pollution severity level
	Pulse voltage test (1,2/50µs)
	Insulation test voltage
	Clearance input/output
<b>Dimensions</b>	
	Clamping range, min./max. (field)
	Clamping range, min./max. (supply)
	Mounting rail
	Length x width
<b>Note</b>	

	SDV541
	2 x AKB (50P)
	SIL3
	2 A
	24 V DC ± 20%
	42 mA
	35 mA
	LED yellow
	AgNi 0.15 gold flashed / NO contact
	250 V AC / 30 V DC
	8 A
	5 A (refer to derating curve)
	5 A (refer to derating curve)
	12 V / 10 mA / 2000 VA
	5 A time-lag
	No
	typ. 7 ms / typ. 14 ms
	-25...50 °C
	-40...85 °C
	50 V AC / 70 V DC
	< 300 V AC
	III
	III
	III
	2
	6 kV
	1.2 kVAC
	≥ 5.5 mm
<b>Screw connection</b>	
	0.13 mm <sup>2</sup> / 2.5 mm <sup>2</sup>
	0.13 mm <sup>2</sup> / 6 mm <sup>2</sup>
	TS 35
	376 mm / 168 mm
	For more technical data about SIL relays 1303890000 and 1303760000 check catalog.weidmueller.com

**Ordering data**

	De-energized to Safe without monitoring
	De-energized to Safe with monitoring
<b>Note</b>	

Type	Height	Order No.
BKP-16DO-SDV541-V0-S	125 mm	2461730000
BKP-16DO-SDV541-V1-S	125 mm	2436230000

**Accessories**

	Supply fuse
	SIL relay without monitoring
	SIL relay with monitoring
	Relay (for alarm)
<b>Note</b>	

Type	Qty.	Order No.
G 20/2.00A/F	10	0430900000
SCS 24VDC P1SIL3DS	1	1303890000
SCS 24VDC P1SIL3DS M	1	1303760000
RSS112024	20	4061590000

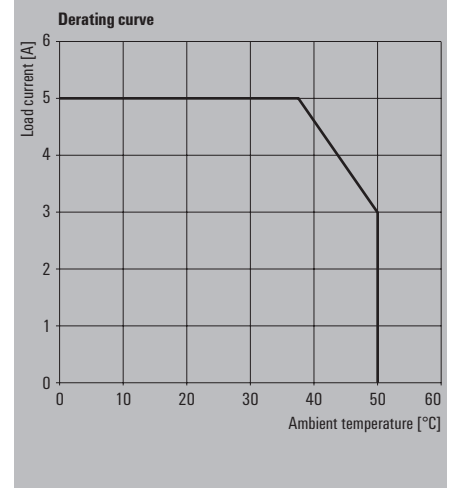
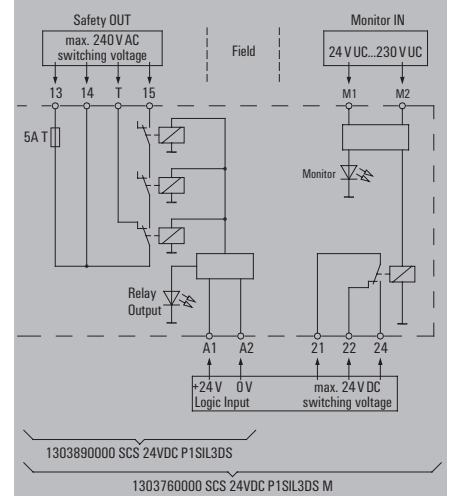
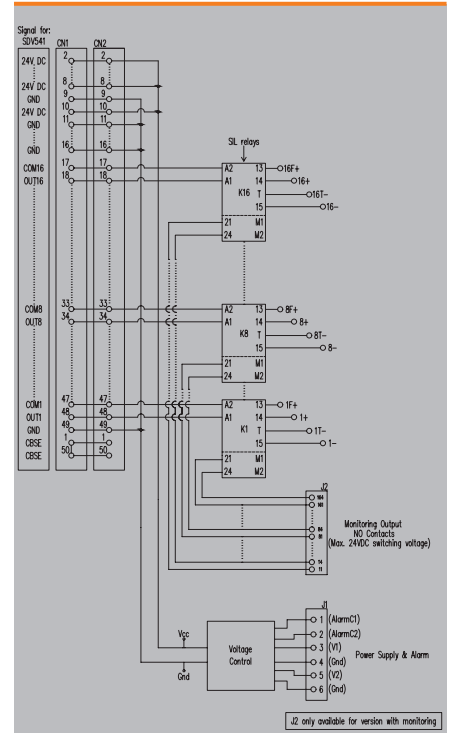



Infrastructure



Device  
Manufacturers



Transportation



Energy



Process



Machinery

Technical data

Size 3

ModuPlug® metal frame

Frame



Deployment	Type	Order No.
	HDC MF 6B AB	1428920000
	HDC MF 6B BA	1428940000

**Note** 2 module slots; double-sided PE screw connection: 0.5 - 10 mm<sup>2</sup> (AWG 20 ... 8); prepared conductor in accordance with IEC 60999-1

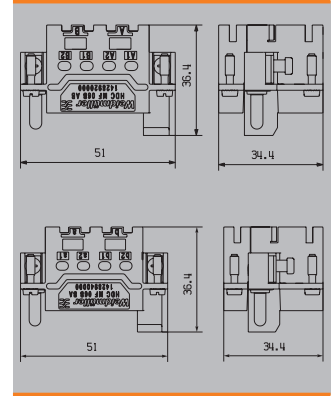

Transport lock



Transport lock for ModuPlug® metal frame		
HDC MF FIXING		1480290000

Size 4

ModuPlug® metal frame

Frame



Deployment	Type	Order No.
	HDC MF 10B AC	1428960000
	HDC MF 10B CA	1428980000

**Note** 3 module slots; double-sided PE screw connection: 0.5 - 10 mm<sup>2</sup> (AWG 20 ... 8); prepared conductor in accordance with IEC 60999-1

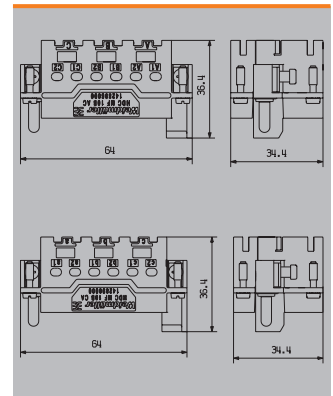

Transport lock



Transport lock for ModuPlug® metal frame		
HDC MF FIXING		1480290000

Technical data

Machinery

Process

Energy

Transportation

Device  
Manufacturers

Infrastructure

Size 6

ModuPlug® metal frame

Frame



Deployment	Type	Order No.
	HDC MF 16B AD	1429010000
	HDC MF 16B DA	1429030000

**Note** 4 module slots; double-sided PE screw connection: 0.5 - 10 mm<sup>2</sup> (AWG 20 ... 8); prepared conductor in accordance with IEC 60999-1

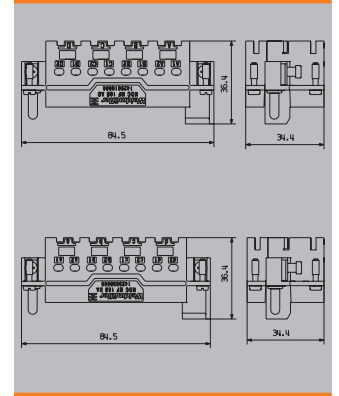

Transport lock



Transport lock for ModuPlug® metal frame		
HDC MF FIXING		1480290000

Size 8

ModuPlug® metal frame

Frame



Deployment	Type	Order No.
	HDC MF 24B AF	1429050000
	HDC MF 24B FA	1429070000

**Note** 6 module slots; double-sided PE screw connection: 0.5 - 10 mm<sup>2</sup> (AWG 20 ... 8); prepared conductor in accordance with IEC 60999-1

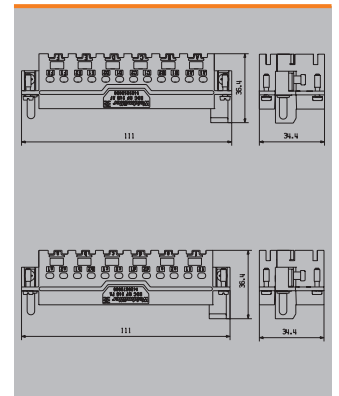

Transport lock



Transport lock for ModuPlug® metal frame		
HDC MF FIXING		1480290000

Technical data

Machinery

Process

Energy

Transportation

Device Manufacturers

Infrastructure

## ModuPlug® HDC MHP 100

### Technical data

Contact inserts	
No. of poles	2
Rated current (DIN EN 61984)	100 A
Rated voltage (DIN EN 61984)	1000 V
Rated impulse voltage (DIN EN 61984)	8 kV
Pollution severity	3
Rated voltage according to UL/CSA	600 V
Insulation resistance	10 <sup>12</sup> Ω
Surge voltage category	III
Limit temperature	-40 °C ... 125 °C
UL 94 flammability rating	V-0
Plugging cycles	≥ 500
Material	Polycarbonate, glass fibre reinforced
Required plug-in slots	1.5

#### Note

HDC-MHP100-modules in the IP65-housing,  
Conductor H07V-K10:

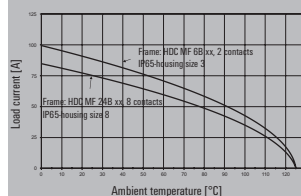

HDC-MHP100-modules in the IP65-housing,  
Conductor H07V-K35:

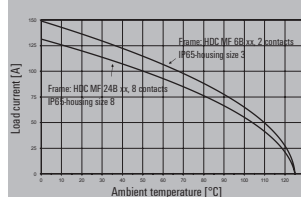

### Crimp connection



Deployment	Type	Order No.
Male	HDC MHP 100 MC	1429060000
Female	HDC MHP 100 FC	1429080000

#### Note

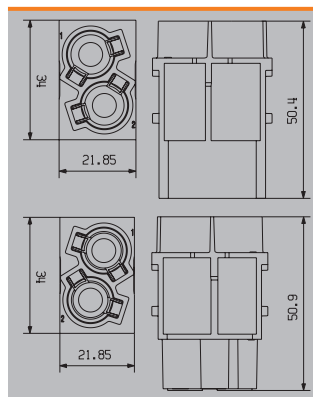

### Accessories

#### Crimp contacts

Surface finish silver



Male			Female		
Qty.	Type	Order No.	Type	Order No.	Order No.
10	HDC MHP100 M 10	1435750000	HDC MHP100 F 10	1435790000	1435790000
10	HDC MHP100 M 16	1435760000	HDC MHP100 F 16	1435810000	1435810000
10	HDC MHP100 M 25	1435770000	HDC MHP100 F 25	1435820000	1435820000
10	HDC MHP100 M 35	1435780000	HDC MHP100 F 35	1435830000	1435830000

#### Tools



<b>Crimping tool</b>	
MTR 110	9018020000
<b>Contact Removal Tool</b>	
HDC MHP REMOVAL TOOL	1480380000
<b>Note</b>	Overview of the crimping inserts in chapter J

Technical data

Machinery

Process

Energy

Transportation

Device Manufacturers

Infrastructure

**ModuPlug®**  
**HDC MHX 4P**

**Technical data**

Contact inserts	
No. of poles	4
Rated current (DIN EN 61984)	40 A
Rated voltage (DIN EN 61984)	830 V
Rated impulse voltage (DIN EN 61984)	8 kV
Pollution severity	3
Rated voltage according to UL/CSA	600 V
Insulation resistance	10 <sup>12</sup> Ω
Surge voltage category	III
Limit temperature	-40 °C ... 125 °C
UL 94 flammability rating	V-0
Plugging cycles	≥ 500
Material	Polycarbonate, glass fibre reinforced
Required plug-in slots	1

**Note**

**Crimp connection**



Deployment	Type	Order No.
Male	HDC MHX 4P MC	1428950000
Female	HDC MHX 4P FC	1428970000

**Note**

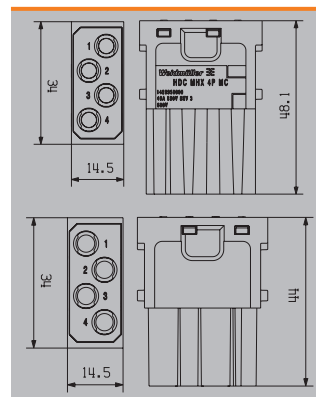

**Accessories**

**Crimp contacts**

Surface finish silver



Male			Female		
Qty.	Type	Order No.	Type	Order No.	Order No.
25	HDC C HX SM1.5AG	1002910000	HDC C HX BM1.5AG	1002950000	1002950000
25	HDC C HX SM2.5AG	1002920000	HDC C HX BM2.5AG	1002960000	1002960000
25	HDC C HX SM4.0AG	1002930000	HDC C HX BM4.0AG	1002970000	1002970000
25	HDC C HX SM6.0AG	1002940000	HDC C HX BM6.0AG	1002980000	1002980000

**Tools**



Crimping tool	
CTIN CM 1.6/2.5	9205430000
Contact Removal Tool	
Removal Tool HX	1002990000
Note	



**ModuPlug®**  
**HDC MXH 3**

**Technical data**

Contact inserts	
No. of poles	3
Rated current (DIN EN 61984)	40 A
Rated voltage (DIN EN 61984)	690 V
Rated impulse voltage (DIN EN 61984)	8 kV
Pollution severity	3
Rated voltage according to UL/CSA	600 V
Insulation resistance	10 <sup>12</sup> Ω
Surge voltage category	III
Limit temperature	-40 °C ... 125 °C
UL 94 flammability rating	V-0
Plugging cycles	≥ 500
Material	Polycarbonate, glass fibre reinforced
Required plug-in slots	1

**Note**

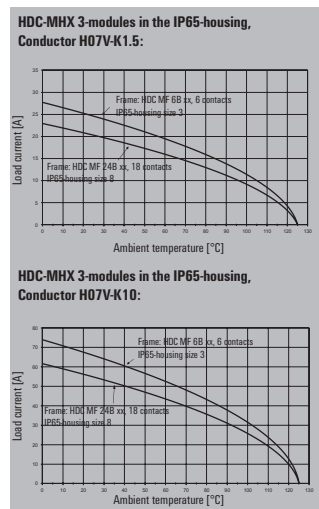

**Crimp connection**



Deployment	Type	Order No.
Male	HDC MXH 3 MC	1429340000
Female	HDC MXH 3 FC	1429350000

**Note**

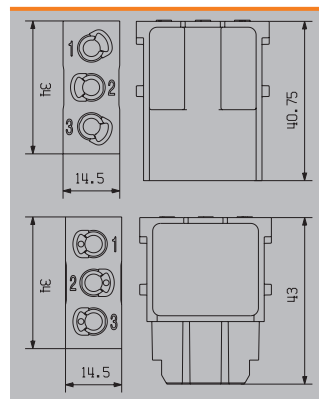

**Accessories**

**Crimp contacts**

Surface finish silver



Male			Female		
Qty.	Type	Order No.	Type	Order No.	Order No.
25	HDC C HX SM1.5AG	1002910000	HDC C HX BM1.5AG	1002950000	1002950000
25	HDC C HX SM2.5AG	1002920000	HDC C HX BM2.5AG	1002960000	1002960000
25	HDC C HX SM4.0AG	1002930000	HDC C HX BM4.0AG	1002970000	1002970000
25	HDC C HX SM6.0AG	1002940000	HDC C HX BM6.0AG	1002980000	1002980000
25	HDC C MXH SM10.0AG	2494550000	HDC C MXH BM10.0AG	2494560000	2494560000

**Tools**



Crimping tool	
CTIN CM 1.6/2.5	9205430000
Contact Removal Tool	
Removal Tool HX	1002990000
Note	



**ModuPlug®**  
**HDC MHE 6P**

**Technical data**

Contact inserts	
No. of poles	6
Rated current (DIN EN 61984)	16 A
Rated voltage (DIN EN 61984)	830 V
Rated impulse voltage (DIN EN 61984)	8 kV
Pollution severity	3
Rated voltage according to UL/CSA	600 V
Insulation resistance	10 <sup>12</sup> Ω
Surge voltage category	III
Limit temperature	-40 °C ... 125 °C
UL 94 flammability rating	V-0
Plugging cycles	≥ 500
Material	Polycarbonate, glass fibre reinforced
Required plug-in slots	1

**Note**

HDC-MHE 6P-modules in the IP65-housing,  
Conductor H05V-K0.5:

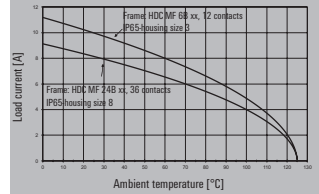

HDC-MHE 6P-modules in the IP65-housing,  
Conductor H07V-K4.0:

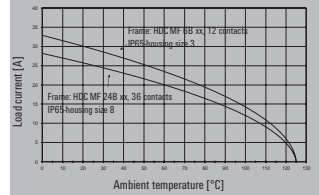

**Crimp connection**



Deployment	Type	Order No.
Male	HDC MHE 6P MC	1505650000
Female	HDC MHE 6P FC	1505660000

**Note**

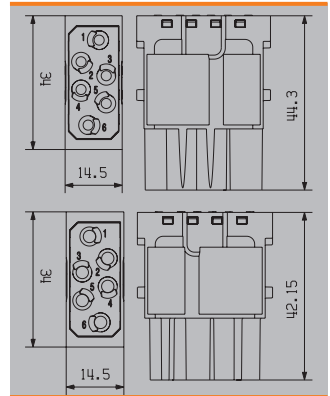

**Accessories**

**Crimp contacts**

Surface finish gold



Surface finish silver



Male			Female		
Qty.	Type	Order No.	Type	Order No.	
100	HDC-C-HE-SM0.5AU	1651420000	HDC-C-HE-BM0.5AU	1651470000	
100	HDC-C-HE-SM0.75-1.00AU	1651430000	HDC-C-HE-BM0.75-1.00AU	1651480000	
100	HDC-C-HE-SM1.5AU	1651440000	HDC-C-HE-BM1.5AU	1651490000	
100	HDC-C-HE-SM2.5AU	1651450000	HDC-C-HE-BM2.5AU	1651500000	
100	HDC-C-HE-SM4.0AU	1651460000	HDC-C-HE-BM4.0AU	1651510000	
100	HDC-C-HE-SM4.65AU	1116540000	HDC-C-HE-BM4.65AU	1116530000	
100	HDC-C-HE-SM0.5AG	1200500000	HDC-C-HE-BM0.5AG	1201100000	
100	HDC-C-HE-SM0.75-1.00AG	1200600000	HDC-C-HE-BM0.75-1.00AG	1201200000	
100	HDC-C-HE-SM1.5AG	1200700000	HDC-C-HE-BM1.5AG	1201300000	
100	HDC-C-HE-SM2.5AG	1200800000	HDC-C-HE-BM2.5AG	1201400000	
100	HDC-C-HE-SM4.0AG	1200900000	HDC-C-HE-BM4.0AG	1201500000	

Conductor cross-section	Insulation stripping length
0.50 mm <sup>2</sup>	AWG 20 7.5 mm
0.75 - 1.00 mm <sup>2</sup>	AWG 18 7.5 mm
1.50 mm <sup>2</sup>	AWG 16 7.5 mm
2.50 mm <sup>2</sup>	AWG 14 7.5 mm
4.00 mm <sup>2</sup>	AWG 12 7.5 mm

**Tools**



Crimping tool	
CTX CM 1.6/2.5	9018490000
CTIN CM 1.6/2.5	9205430000
Contact Removal Tool	
Removal Tool HE	1866750000

**Note**

## ModuPlug® HDC MHE 20

### Technical data

Contact inserts	
No. of poles	20
Rated current (DIN EN 61984)	16 A
Rated voltage (DIN EN 61984)	500 V
Rated impulse voltage (DIN EN 61984)	6 kV
Pollution severity	3
Rated voltage according to UL/CSA	600 V
Insulation resistance	10 <sup>12</sup> Ω
Surge voltage category	III
Limit temperature	-40 °C ... 125 °C
UL 94 flammability rating	V-0
Plugging cycles	≥ 500
Material	Polycarbonate, glass fibre reinforced
Required plug-in slots	2

#### Note

HDC-MHE 20-modules in the IP65-housing,  
Conductor H05V-K0.5:

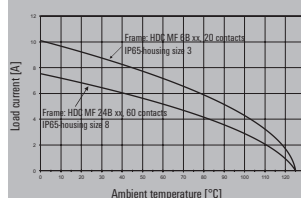

HDC-MHE 20-modules in the IP65-housing,  
Conductor H07V-K4.0:

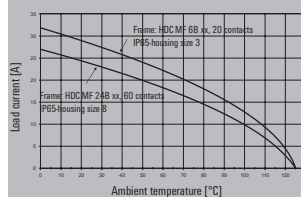

### Crimp connection



Deployment	Type	Order No.
Male	HDC MHE 20 MC	1428910000
Female	HDC MHE 20 FC	1428930000

#### Note

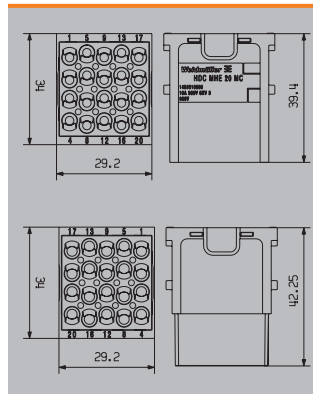

### Accessories

#### Crimp contacts

Surface finish gold



Surface finish silver



Male			Female		
Qty.	Type	Order No.	Type	Order No.	Order No.
100	HDC-C-HE-SM0.5AU	1651420000	HDC-C-HE-BM0.5AU	1651470000	1651470000
100	HDC-C-HE-SM0.75-1.00AU	1651430000	HDC-C-HE-BM0.75-1.00AU	1651480000	1651480000
100	HDC-C-HE-SM1.5AU	1651440000	HDC-C-HE-BM1.5AU	1651490000	1651490000
100	HDC-C-HE-SM2.5AU	1651450000	HDC-C-HE-BM2.5AU	1651500000	1651500000
100	HDC-C-HE-SM4.0AU	1651460000	HDC-C-HE-BM4.0AU	1651510000	1651510000
100	HDC-C-HE-SM4.65AU	1116540000	HDC-C-HE-BM4.65AU	1116530000	1116530000
100	HDC-C-HE-SM0.5AG	1200500000	HDC-C-HE-BM0.5AG	1201100000	1201100000
100	HDC-C-HE-SM0.75-1.00AG	1200600000	HDC-C-HE-BM0.75-1.00AG	1201200000	1201200000
100	HDC-C-HE-SM1.5AG	1200700000	HDC-C-HE-BM1.5AG	1201300000	1201300000
100	HDC-C-HE-SM2.5AG	1200800000	HDC-C-HE-BM2.5AG	1201400000	1201400000
100	HDC-C-HE-SM4.0AG	1200900000	HDC-C-HE-BM4.0AG	1201500000	1201500000

Conductor cross-section	Insulation stripping length
0.50 mm <sup>2</sup>	AWG 20 7.5 mm
0.75 - 1.00 mm <sup>2</sup>	AWG 18 7.5 mm
1.50 mm <sup>2</sup>	AWG 16 7.5 mm
2.50 mm <sup>2</sup>	AWG 14 7.5 mm
4.00 mm <sup>2</sup>	AWG 12 7.5 mm

#### Tools



Crimping tool	
CTX CM 1.6/2.5	9018490000
CTIN CM 1.6/2.5	9205430000
Contact Removal Tool	
Removal Tool HE	1866750000

#### Note

# ModuPlug® HDC MHE 8

## Technical data

Contact inserts	
No. of poles	8
Rated current (DIN EN 61984)	16 A
Rated voltage (DIN EN 61984)	400 V
Rated impulse voltage (DIN EN 61984)	6 kV
Pollution severity	3
Rated voltage according to UL/CSA	600 V
Insulation resistance	10 <sup>12</sup> Ω
Surge voltage category	III
Limit temperature	-40 °C ... 125 °C
UL 94 flammability rating	V-0
Plugging cycles	≥ 500
Material	Polycarbonate, glass fibre reinforced
Required plug-in slots	1

**Note**

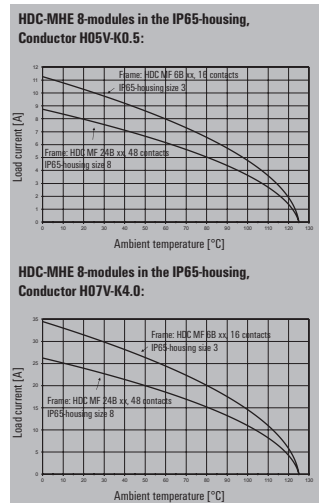

## Crimp connection



Deployment	Type	Order No.
Male	HDC MHE 8 MC	1428880000
Female	HDC MHE 8 FC	1428890000

**Note**

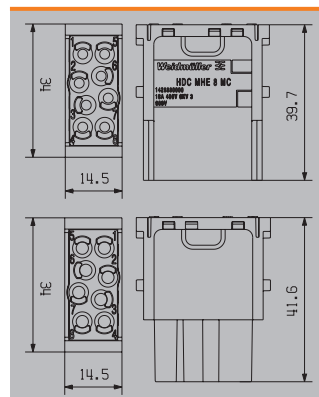

## Accessories

### Crimp contacts

Surface finish gold



Surface finish silver



Male			Female		
Qty.	Type	Order No.	Type	Order No.	Order No.
100	HDC-C-HE-SM0.5AU	1651420000	HDC-C-HE-BM0.5AU	1651470000	1651470000
100	HDC-C-HE-SM0.75-1.00AU	1651430000	HDC-C-HE-BM0.75-1.00AU	1651480000	1651480000
100	HDC-C-HE-SM1.5AU	1651440000	HDC-C-HE-BM1.5AU	1651490000	1651490000
100	HDC-C-HE-SM2.5AU	1651450000	HDC-C-HE-BM2.5AU	1651500000	1651500000
100	HDC-C-HE-SM4.0AU	1651460000	HDC-C-HE-BM4.0AU	1651510000	1651510000
100	HDC-C-HE-SM4.65AU	1116540000	HDC-C-HE-BM4.65AU	1116530000	1116530000
100	HDC-C-HE-SM0.5AG	1200500000	HDC-C-HE-BM0.5AG	1201100000	1201100000
100	HDC-C-HE-SM0.75-1.00AG	1200600000	HDC-C-HE-BM0.75-1.00AG	1201200000	1201200000
100	HDC-C-HE-SM1.5AG	1200700000	HDC-C-HE-BM1.5AG	1201300000	1201300000
100	HDC-C-HE-SM2.5AG	1200800000	HDC-C-HE-BM2.5AG	1201400000	1201400000
100	HDC-C-HE-SM4.0AG	1200900000	HDC-C-HE-BM4.0AG	1201500000	1201500000

Conductor cross-section	Insulation stripping length
0.50 mm <sup>2</sup>	AWG 20 7.5 mm
0.75 - 1.00 mm <sup>2</sup>	AWG 18 7.5 mm
1.50 mm <sup>2</sup>	AWG 16 7.5 mm
2.50 mm <sup>2</sup>	AWG 14 7.5 mm
4.00 mm <sup>2</sup>	AWG 12 7.5 mm

### Tools



Crimping tool	
CTX CM 1.6/2.5	9018490000
CTIN CM 1.6/2.5	9205430000
Contact Removal Tool	
Removal Tool HE	1866750000
Note	



**ModuPlug®**  
**HDC MHE 6**

**Technical data**

Contact inserts	
No. of poles	6
Rated current (DIN EN 61984)	16 A
Rated voltage (DIN EN 61984)	500 V
Rated impulse voltage (DIN EN 61984)	6 kV
Pollution severity	3
Rated voltage according to UL/CSA	600 V
Insulation resistance	10 <sup>12</sup> Ω
Surge voltage category	III
Limit temperature	-40 °C ... 125 °C
UL 94 flammability rating	V-0
Plugging cycles	≥ 500
Material	Polycarbonate, glass fibre reinforced
Required plug-in slots	1

**Note**

**HDC-MHE 6-modules in the IP65-housing, Conductor H05V-K0.5:**

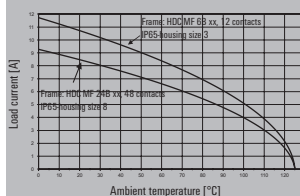

**HDC-MHE 6-modules in the IP65-housing, Conductor H07V-K4.0:**

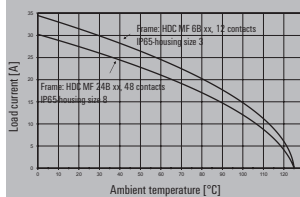

**Crimp connection**



Deployment	Type	Order No.
Male	HDC MHE 6 MC	1429360000
Female	HDC MHE 6 FC	1429370000

**Note**

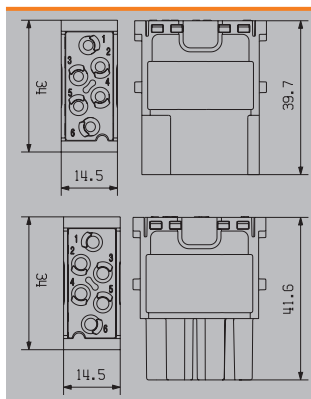

**Accessories**

**Crimp contacts**

Surface finish gold



Surface finish silver



Male			Female		
Qty.	Type	Order No.	Type	Order No.	
100	HDC-C-HE-SM0.5AU	1651420000	HDC-C-HE-BM0.5AU	1651470000	
100	HDC-C-HE-SM0.75-1.00AU	1651430000	HDC-C-HE-BM0.75-1.00AU	1651480000	
100	HDC-C-HE-SM1.5AU	1651440000	HDC-C-HE-BM1.5AU	1651490000	
100	HDC-C-HE-SM2.5AU	1651450000	HDC-C-HE-BM2.5AU	1651500000	
100	HDC-C-HE-SM4.0AU	1651460000	HDC-C-HE-BM4.0AU	1651510000	
100	HDC-C-HE-SM4.65AU	1116540000	HDC-C-HE-BM4.65AU	1116530000	
100	HDC-C-HE-SM0.5AG	1200500000	HDC-C-HE-BM0.5AG	1201100000	
100	HDC-C-HE-SM0.75-1.00AG	1200600000	HDC-C-HE-BM0.75-1.00AG	1201200000	
100	HDC-C-HE-SM1.5AG	1200700000	HDC-C-HE-BM1.5AG	1201300000	
100	HDC-C-HE-SM2.5AG	1200800000	HDC-C-HE-BM2.5AG	1201400000	
100	HDC-C-HE-SM4.0AG	1200900000	HDC-C-HE-BM4.0AG	1201500000	

Conductor cross-section	Insulation stripping length
0.50 mm <sup>2</sup>	AWG 20 7.5 mm
0.75 - 1.00 mm <sup>2</sup>	AWG 18 7.5 mm
1.50 mm <sup>2</sup>	AWG 16 7.5 mm
2.50 mm <sup>2</sup>	AWG 14 7.5 mm
4.00 mm <sup>2</sup>	AWG 12 7.5 mm

**Tools**



Crimping tool	
CTX CM 1.6/2.5	9018490000
CTIN CM 1.6/2.5	9205430000
Contact Removal Tool	
Removal Tool HE	1866750000

**Note**

Technical data

Machinery

Process

Energy

Transportation

Device Manufacturers

Infrastructure

**ModuPlug®**  
**HDC MHD 36**

**Technical data**

Contact inserts	
No. of poles	36
Rated current (DIN EN 61984)	10 A
Rated voltage (DIN EN 61984)	250 V
Rated impulse voltage (DIN EN 61984)	4 kV
Pollution severity	3
Rated voltage according to UL/CSA	600 V
Insulation resistance	10 <sup>12</sup> Ω
Surge voltage category	III
Limit temperature	-40 °C ... 125 °C
UL 94 flammability rating	V-0
Plugging cycles	≥ 500
Material	Polycarbonate, glass fibre reinforced
Required plug-in slots	2

**Note**

**HDC-MHD 36-modules in the IP65-housing,  
Conductor H05V-K0.5:**

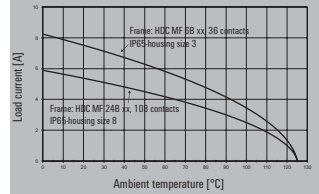

**HDC-MHD 36-modules in the IP65-housing,  
Conductor H07V-K2.5:**

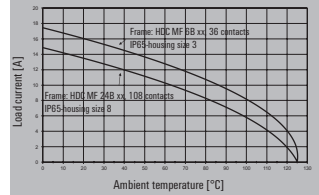

**Modules**

**Crimp connection**



Deployment	Type	Order No.
Male	HDC MHD 36 MC	1428860000
Female	HDC MHD 36 FC	1428870000

**Note**

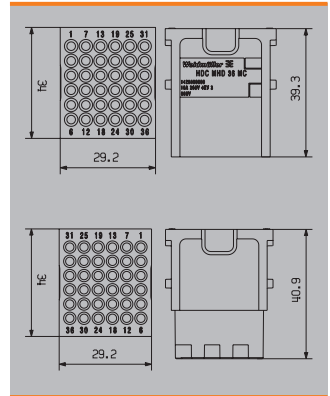

**Accessories**

**Crimp contacts**

Surface finish gold



Surface finish silver



Male			Female		
Qty.	Type	Order No.	Type	Order No.	Order No.
100	HDC-C-HD-SM0.14-0.37AU	1651620000	HDC-C-HD-BM0.14-0.37AU	1651670000	
100	HDC-C-HD-SM0.5AU	1651630000	HDC-C-HD-BM0.5AU	1651680000	
100	HDC-C-HD-SM0.75-1.00AU	1651640000	HDC-C-HD-BM0.75-1.00AU	1651690000	
100	HDC-C-HD-SM1.5AU	1651650000	HDC-C-HD-BM1.5AU	1651700000	
100	HDC-C-HD-SM2.5AU	1651660000	HDC-C-HD-BM2.5AU	1651710000	
100	HDC-C-HD-SM0.14-0.37AG	1651520000	HDC-C-HD-BM0.14-0.37AG	1651570000	
100	HDC-C-HD-SM0.5AG	1651530000	HDC-C-HD-BM0.5AG	1651580000	
100	HDC-C-HD-SM0.75-1.00AG	1601750000	HDC-C-HD-BM0.75-1.00AG	1601760000	
100	HDC-C-HD-SM1.5AG	1651550000	HDC-C-HD-BM1.5AG	1651600000	
100	HDC-C-HD-SM2.5AG	1651560000	HDC-C-HD-BM2.5AG	1651610000	

Conductor cross-section	Insulation stripping length
0.14 - 0.37 mm <sup>2</sup>	AWG 26-22 8 mm
0.50 mm <sup>2</sup>	AWG 20 8 mm
0.75 - 1.00 mm <sup>2</sup>	AWG 18 8 mm
1.50 mm <sup>2</sup>	AWG 16 8 mm
2.50 mm <sup>2</sup>	AWG 14 6 mm

**Tools**



Crimping tool	
CTX CM 1.6/2.5	9018490000
CTIN CM 1.6/2.5	9205430000
Contact Removal Tool	
REMOVAL TOOL HD	1866730000
Note	

## ModuPlug® HDC MHD 12

### Technical data

Contact inserts	
No. of poles	12
Rated current (DIN EN 61984)	10 A
Rated voltage (DIN EN 61984)	250 V
Rated impulse voltage (DIN EN 61984)	4 kV
Pollution severity	3
Rated voltage according to UL/CSA	600 V
Insulation resistance	10 <sup>12</sup> Ω
Surge voltage category	III
Limit temperature	-40 °C ... 125 °C
UL 94 flammability rating	V-0
Plugging cycles	≥ 500
Material	Polycarbonate, glass fibre reinforced
Required plug-in slots	1

#### Note

HDC-MHD 12-modules in the IP65-housing,  
Conductor H05V-K0.5:

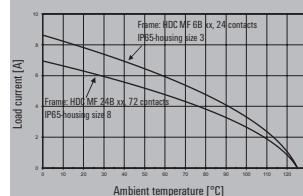

HDC-MHD 12-modules in the IP65-housing,  
Conductor H07V-K2.5:

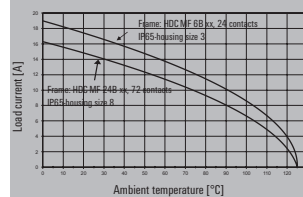

### Crimp connection



Deployment	Type	Order No.
Male	HDC MHD 12 MC	1428840000
Female	HDC MHD 12 FC	1428850000

#### Note

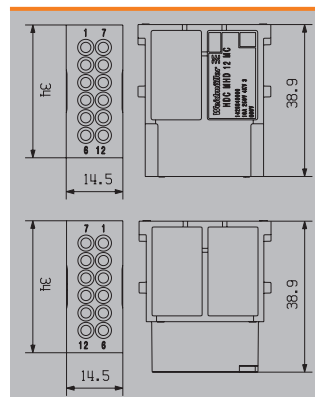

### Accessories

#### Crimp contacts

Surface finish gold



Surface finish silver



Male			Female		
Qty.	Type	Order No.	Type	Order No.	Order No.
100	HDC-C-HD-SM0.14-0.37AU	1651620000	HDC-C-HD-BM0.14-0.37AU	1651670000	1651670000
100	HDC-C-HD-SM0.5AU	1651630000	HDC-C-HD-BM0.5AU	1651680000	1651680000
100	HDC-C-HD-SM0.75-1.00AU	1651640000	HDC-C-HD-BM0.75-1.00AU	1651690000	1651690000
100	HDC-C-HD-SM1.5AU	1651650000	HDC-C-HD-BM1.5AU	1651700000	1651700000
100	HDC-C-HD-SM2.5AU	1651660000	HDC-C-HD-BM2.5AU	1651710000	1651710000
100	HDC-C-HD-SM0.14-0.37AG	1651520000	HDC-C-HD-BM0.14-0.37AG	1651570000	1651570000
100	HDC-C-HD-SM0.5AG	1651530000	HDC-C-HD-BM0.5AG	1651580000	1651580000
100	HDC-C-HD-SM0.75-1.00AG	1601750000	HDC-C-HD-BM0.75-1.00AG	1601760000	1601760000
100	HDC-C-HD-SM1.5AG	1651550000	HDC-C-HD-BM1.5AG	1651600000	1651600000
100	HDC-C-HD-SM2.5AG	1651560000	HDC-C-HD-BM2.5AG	1651610000	1651610000

Conductor cross-section	Insulation stripping length
0.14 - 0.37 mm <sup>2</sup>	AWG 26-22 8 mm
0.50 mm <sup>2</sup>	AWG 20 8 mm
0.75 - 1.00 mm <sup>2</sup>	AWG 18 8 mm
1.50 mm <sup>2</sup>	AWG 16 8 mm
2.50 mm <sup>2</sup>	AWG 14 6 mm

#### Tools



Crimping tool	
CTX CM 1.6/2.5	9018490000
CTIN CM 1.6/2.5	9205430000
Contact Removal Tool	
REMOVAL TOOL HD	1866730000

#### Note

Technical data

Machinery

Process

Energy

Transportation

Device Manufacturers

Infrastructure

**ModuPlug®**  
**HDC MBUS 2**

**Technical data**

Contact inserts	
No. of poles	
Rated current (DIN EN 61984)	
Rated voltage (DIN EN 61984)	
Rated impulse voltage (DIN EN 61984)	
Pollution severity	3
Rated voltage according to UL/CSA	
Insulation resistance	10 <sup>12</sup> Ω
Surge voltage category	III
Limit temperature	-40 °C ... 125 °C
UL 94 flammability rating	V-0
Plugging cycles	≥ 500
Material	Polycarbonate, glass fibre reinforced
Required plug-in slots	1

**Note**

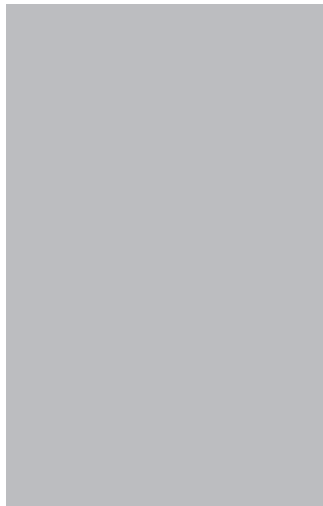

Deployment	Type	Order No.
Male	HDC MBUS 2 MC	1428990000
Female	HDC MBUS 2 FC	1429020000

**Note**

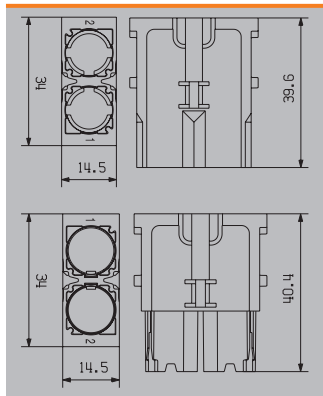

**Fixing clip**



Fixing clip	Order No.
HDC MBUS 2 MCLIP	1989290000
HDC MBUS 2 PCLIP	1989300000

**Note** MCLIP = metal version; PCLIP = plastic version

**ModuPlug®  
HDC MDU**

**Technical data**

Contact inserts	
No. of poles	
Rated current (DIN EN 61984)	
Rated voltage (DIN EN 61984)	
Rated impulse voltage (DIN EN 61984)	
Pollution severity	3
Rated voltage according to UL/CSA	
Insulation resistance	10 <sup>12</sup> Ω
Surge voltage category	
Limit temperature	-40 °C ... 125 °C
UL 94 flammability rating	V-0
Plugging cycles	≥ 500
Material	Polycarbonate, glass fibre reinforced
Required plug-in slots	0.5

**Note**



Deployment	Type	Order No.
	HDC MDU	<b>1429040000</b>

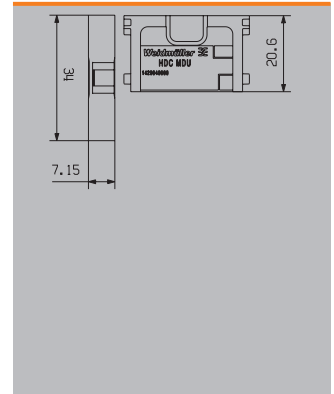

**Note**

Technical data

Machinery

Process

Energy

Transportation

Device  
Manufacturers

Infrastructure





Infrastructure



Device  
Manufacturers



Transportation



Energy



Process



Machinery

Technical data

Cat. 5e

Technical data

No. of poles	4
Transmission rate	100 Mbit/s
Category	Cat. 5e
Coding	D
Rated current	4 A
Rated voltage	250 V
Pollution severity	2
Insulation resistance	≥ 10 <sup>9</sup> Ω
Limit temperature	-30 °C ... 90 °C
Plugging cycles	≥ 100
Contact surface	Au (Gold)

**Note**  
Round plug-in connector in accordance with IEC 61076-2-101



Module side version	Cable length	Opposite side version	Type	Order No.
Female	1 m	open	HDC XX5E01 FOXXXXX-0100	2003920100
Male	1 m	open	HDC XX5E01 MOXXXXX-0100	2003890100
Male	0.5 m	Female, straight	HDC XX5E01 MFSXXX-0050	2453550050
Male	1 m	Female, straight	HDC XX5E01 MFSXXX-0100	2453550100
Male	1.5 m	Female, straight	HDC XX5E01 MFSXXX-0150	2453550150
Male	3 m	Female, straight	HDC XX5E01 MFSXXX-0300	2453550300
Male	5 m	Female, straight	HDC XX5E01 MFSXXX-0500	2453550500
Female	1 m	Male, straight, M12D	HDC XX5E01 FMSM12D-0100	2451120100
Male	1 m	Male, straight, M12D	HDC XX5E01 MMSM12D-0100	2451110100
Male	1 m	Male, straight, RJ45	HDC XX5E01 MMSRJ45-0100	2450490100
Female	1 m	Male, straight, RJ45	HDC XX5E01 FMSRJ45-0100	2451080100

**Note** Other versions and cable lengths on request

Technical data

Machinery

Process

Energy

Transportation

Device  
Manufacturers

Infrastructure

Cat. 6<sub>A</sub>

## Technical data

No. of poles	8
Transmission rate	10 GBit/s
Category	Cat. 6A
Coding	X
Rated current	0.5 A
Rated voltage	50 V
Pollution severity	2
Insulation resistance	≥ 10 <sup>9</sup> Ω
Limit temperature	-30 °C ... 90 °C
Plugging cycles	≥ 100
Contact surface	Au (Gold)

**Note**

Round plug-in connector in accordance with IEC 61076-2-109



Module side version	Cable length	Opposite side version	Type	Order No.
Female	1 m	open	HDC XX6A01 FOXXXXX-0100	2003850100
Male	1 m	open	HDC XX6A01 MOXXXXX-0100	2003820100
Male	0.5 m	Female, straight	HDC XX6A01 MFSXXXX-0050	2453540050
Male	1 m	Female, straight	HDC XX6A01 MFSXXXX-0100	2453540100
Male	1.5 m	Female, straight	HDC XX6A01 MFSXXXX-0150	2453540150
Male	3 m	Female, straight	HDC XX6A01 MFSXXXX-0300	2453540300
Male	5 m	Female, straight	HDC XX6A01 MFSXXXX-0500	2453540500
Male	1 m	Male, straight, M12X	HDC XX6A01 MMSM12X-0100	2451130100
Female	1 m	Male, straight, M12X	HDC XX6A01 FMSM12X-0100	2451140100
Male	1 m	Male, straight, RJ45	HDC XX6A01 MMSRJ45-0100	2451090100
Female	1 m	Male, straight, RJ45	HDC XX6A01 FMSRJ45-0100	2451100100

**Note**

Other versions and cable lengths on request

**One end without connector**  
**M12**  
**L-coded**



Technical data

Machinery

Process

Energy

Transportation

Device Manufacturers

Infrastructure

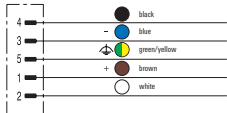
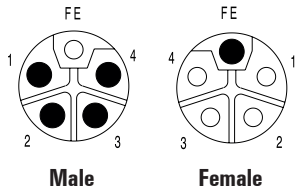

**Ordering data**

Male, straight	
PUR halogen-free	1.5 m
PUR halogen-free	3.0 m
PUR halogen-free	5.0 m
PUR halogen-free	10.0 m
Male, angled	
PUR halogen-free	1.5 m
PUR halogen-free	3.0 m
PUR halogen-free	5.0 m
PUR halogen-free	10.0 m
Female, straight	
PUR halogen-free	1.5 m
PUR halogen-free	3.0 m
PUR halogen-free	5.0 m
PUR halogen-free	10.0 m
Female, angled	
PUR halogen-free	1.5 m
PUR halogen-free	3.0 m
PUR halogen-free	5.0 m
PUR halogen-free	10.0 m
Note	

SAIL-M12G-L-1.5P	2455220150
SAIL-M12G-L-3.0P	2455220300
SAIL-M12G-L-5.0P	2455220500
SAIL-M12G-L-10P	2455221000
SAIL-M12W-L-1.5P	2455240150
SAIL-M12W-L-3.0P	2455240300
SAIL-M12W-L-5.0P	2455240500
SAIL-M12W-L-10P	2455241000
SAIL-M12BG-L-1.5P	2455330150
SAIL-M12BG-L-3.0P	2455330300
SAIL-M12BG-L-5.0P	2455330500
SAIL-M12BG-L-10P	2455331000
SAIL-M12BW-L-1.5P	2455200150
SAIL-M12BW-L-3.0P	2455200300
SAIL-M12BW-L-5.0P	2455200500
SAIL-M12BW-L-10P	2455201000

**Dimensioned drawing**

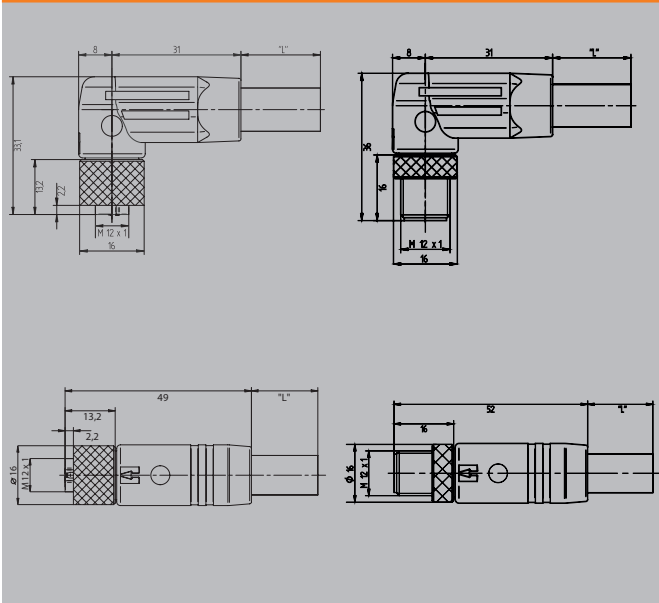

**Technical data**

Rated current	16 A
Protection degree	IP65, IP67, when screwed in
Core cross-section	1.5 mm <sup>2</sup>
Contact surface	Gold-plated
Temperature range of housing	-30...+90 °C
Rated voltage	50 V
Approvals	cULus

## Connecting cables

M12

L-coded

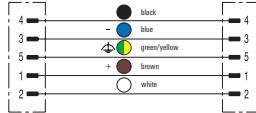
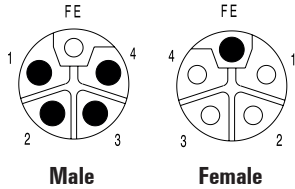

## Ordering data

Male, straight - Female, straight	
PUR halogen-free	1.5 m
PUR halogen-free	3.0 m
PUR halogen-free	5.0 m
PUR halogen-free	10.0 m
Male, straight - Female, angled	
PUR halogen-free	1.5 m
PUR halogen-free	3.0 m
PUR halogen-free	5.0 m
PUR halogen-free	10.0 m
Male, angled - Female, angled	
PUR halogen-free	1.5 m
PUR halogen-free	3.0 m
PUR halogen-free	5.0 m
PUR halogen-free	10.0 m
Male, angled - female, straight	
PUR halogen-free	1.5 m
PUR halogen-free	3.0 m
PUR halogen-free	5.0 m
PUR halogen-free	10.0 m
<b>Note</b>	

SAIL-M12GM12G-L-1.5P	<b>2455260150</b>
SAIL-M12GM12G-L-3.0P	<b>2455260300</b>
SAIL-M12GM12G-L-5.0P	<b>2455260500</b>
SAIL-M12GM12G-L-10P	<b>2455261000</b>
SAIL-M12GM12W-L-1.5P	<b>2455280150</b>
SAIL-M12GM12W-L-3.0P	<b>2455280300</b>
SAIL-M12GM12W-L-5.0P	<b>2455280500</b>
SAIL-M12GM12W-L-10P	<b>2455281000</b>
SAIL-M12WM12W-L-1.5P	<b>2455300150</b>
SAIL-M12WM12W-L-3.0P	<b>2455300300</b>
SAIL-M12WM12W-L-5.0P	<b>2455300500</b>
SAIL-M12WM12W-L-10P	<b>2455301000</b>
SAIL-M12WM12G-L-1.5P	<b>2455320150</b>
SAIL-M12WM12G-L-3.0P	<b>2455320300</b>
SAIL-M12WM12G-L-5.0P	<b>2455320500</b>
SAIL-M12WM12G-L-10P	<b>2455321000</b>

## Technical data

Rated current	16 A
Protection degree	IP65, IP67, when screwed in
Core cross-section	1.5 mm <sup>2</sup>
Contact surface	Gold-plated
Temperature range of housing	-30...+90 °C
Rated voltage	50 V
Approvals	cULus

## Dimensioned drawing

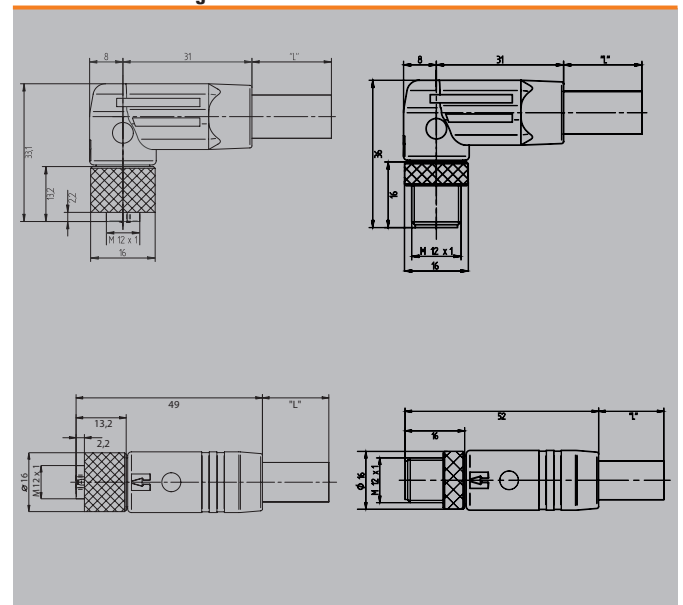

One end without connector  
M12  
K-coded

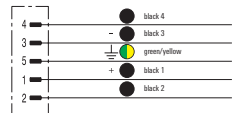
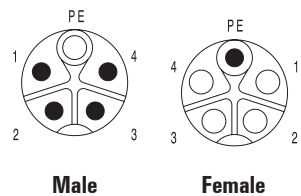

Ordering data

Configuration	Length	Part Number	Order Code
<b>Male, straight</b>			
PUR halogen-free	1.5 m	SAIL-M12G-K-1.5P	2455210150
PUR halogen-free	3.0 m	SAIL-M12G-K-3.0P	2455210300
PUR halogen-free	5.0 m	SAIL-M12G-K-5.0P	2455210500
PUR halogen-free	10.0 m	SAIL-M12G-K-10P	2455211000
<b>Male, angled</b>			
PUR halogen-free	1.5 m	SAIL-M12W-K-1.5P	2455230150
PUR halogen-free	3.0 m	SAIL-M12W-K-3.0P	2455230300
PUR halogen-free	5.0 m	SAIL-M12W-K-5.0P	2455230500
PUR halogen-free	10.0 m	SAIL-M12W-K-10P	2455231000
<b>Female, straight</b>			
PUR halogen-free	1.5 m	SAIL-M12BG-K-1.5P	2455150150
PUR halogen-free	3.0 m	SAIL-M12BG-K-3.0P	2455150300
PUR halogen-free	5.0 m	SAIL-M12BG-K-5.0P	2455150500
PUR halogen-free	10.0 m	SAIL-M12BG-K-10P	2455151000
<b>Female, angled</b>			
PUR halogen-free	1.5 m	SAIL-M12BW-K-1.5P	2455190150
PUR halogen-free	3.0 m	SAIL-M12BW-K-3.0P	2455190300
PUR halogen-free	5.0 m	SAIL-M12BW-K-5.0P	2455190500
PUR halogen-free	10.0 m	SAIL-M12BW-K-10P	2455191000
<b>Note</b>			

Technical data

Rated current	16 A
Protection degree	IP65, IP67, when screwed in
Core cross-section	1.5 mm <sup>2</sup>
Contact surface	Gold-plated
Temperature range of housing	-30...+90 °C
Rated voltage	600 V
Approvals	cULus

Dimensioned drawing

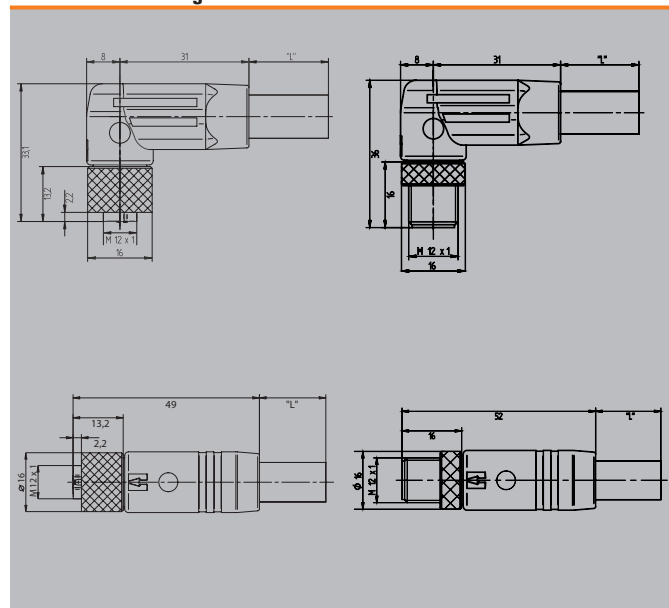

**Connecting cables**  
**M12**  
**K-coded**

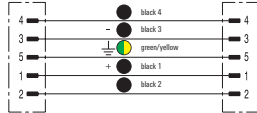
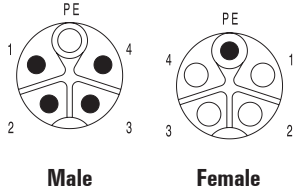

**Ordering data**

Male, straight - Female, straight	
PUR halogen-free	1.5 m
PUR halogen-free	3.0 m
PUR halogen-free	5.0 m
PUR halogen-free	10.0 m
Male, straight - Female, angled	
PUR halogen-free	1.5 m
PUR halogen-free	3.0 m
PUR halogen-free	5.0 m
PUR halogen-free	10.0 m
Male, angled - Female, angled	
PUR halogen-free	1.5 m
PUR halogen-free	3.0 m
PUR halogen-free	5.0 m
PUR halogen-free	10.0 m
Male, angled - female, straight	
PUR halogen-free	1.5 m
PUR halogen-free	3.0 m
PUR halogen-free	5.0 m
PUR halogen-free	10.0 m
Note	

SAIL-M12GM12G-K-1.5P	<b>2455250150</b>
SAIL-M12GM12G-K-3.0P	<b>2455250300</b>
SAIL-M12GM12G-K-5.0P	<b>2455250500</b>
SAIL-M12GM12G-K-10P	<b>2455251000</b>
SAIL-M12GM12W-K-1.5P	<b>2455270150</b>
SAIL-M12GM12W-K-3.0P	<b>2455270300</b>
SAIL-M12GM12W-K-5.0P	<b>2455270500</b>
SAIL-M12GM12W-K-10P	<b>2455271000</b>
SAIL-M12WM12W-K-1.5P	<b>2455290150</b>
SAIL-M12WM12W-K-3.0P	<b>2455290300</b>
SAIL-M12WM12W-K-5.0P	<b>2455290500</b>
SAIL-M12WM12W-K-10P	<b>2455291000</b>
SAIL-M12WM12G-K-1.5P	<b>2455310150</b>
SAIL-M12WM12G-K-3.0P	<b>2455310300</b>
SAIL-M12WM12G-K-5.0P	<b>2455310500</b>
SAIL-M12WM12G-K-10P	<b>2455311000</b>

**Technical data**

Rated current	16 A
Protection degree	IP65, IP67, when screwed in
Core cross-section	1.5 mm <sup>2</sup>
Contact surface	Gold-plated
Temperature range of housing	-30...+90 °C
Rated voltage	600 V
Approvals	cULus

**Dimensioned drawing**

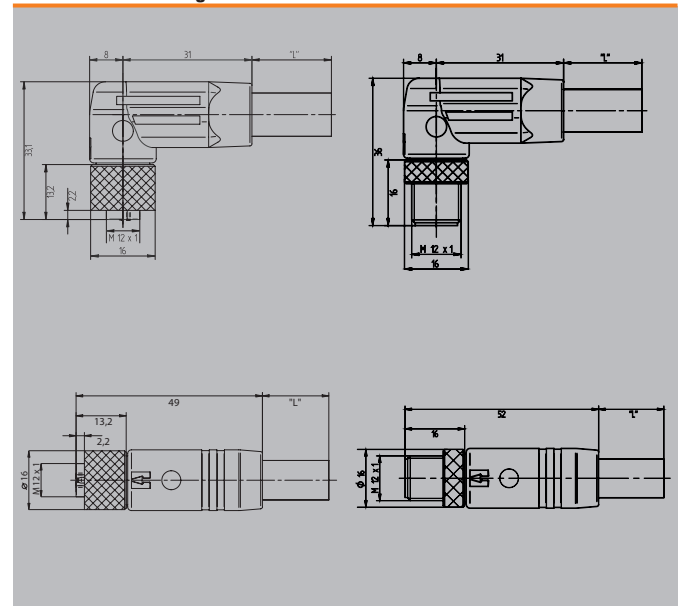

Technical data  
Machinery  
Process  
Energy  
Transportation  
Device Manufacturers  
Infrastructure

One end without connector  
M12  
S-coded

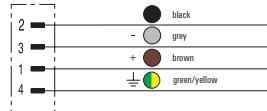
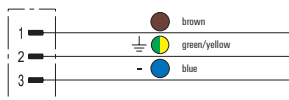
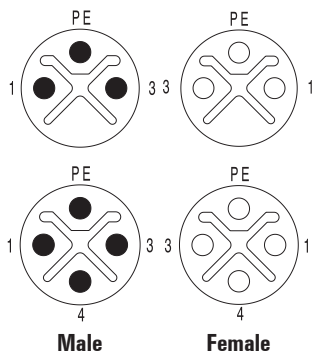

Ordering data

Male, straight	
PUR halogen-free	1.5 m
PUR halogen-free	3.0 m
PUR halogen-free	5.0 m
PUR halogen-free	10.0 m
Male, angled	
PUR halogen-free	1.5 m
PUR halogen-free	3.0 m
PUR halogen-free	5.0 m
PUR halogen-free	10.0 m
Female, straight	
PUR halogen-free	1.5 m
PUR halogen-free	3.0 m
PUR halogen-free	5.0 m
PUR halogen-free	10.0 m
Female, angled	
PUR halogen-free	1.5 m
PUR halogen-free	3.0 m
PUR halogen-free	5.0 m
PUR halogen-free	10.0 m
Note	

3-pole	
SAIL-M12G-S3-1.5P	2050020150
SAIL-M12G-S3-3.0P	2050020300
SAIL-M12G-S3-5.0P	2050020500
SAIL-M12G-S3-10P	2050021000
SAIL-M12W-S3-1.5P	2050050150
SAIL-M12W-S3-3.0P	2050050300
SAIL-M12W-S3-5.0P	2050050500
SAIL-M12W-S3-10P	2050051000
SAIL-M12BG-S3-1.5P	2049950150
SAIL-M12BG-S3-3.0P	2049950300
SAIL-M12BG-S3-5.0P	2049950500
SAIL-M12BG-S3-10P	2049951000
SAIL-M12BW-S3-1.5P	2050010150
SAIL-M12BW-S3-3.0P	2050010300
SAIL-M12BW-S3-5.0P	2050010500
SAIL-M12BW-S3-10P	2050011000

4-pole	
SAIL-M12G-S-1.5P	2050230150
SAIL-M12G-S-3.0P	2050230300
SAIL-M12G-S-5.0P	2050230500
SAIL-M12G-S-10P	2050231000
SAIL-M12W-S-1.5P	2050260150
SAIL-M12W-S-3.0P	2050260300
SAIL-M12W-S-5.0P	2050260500
SAIL-M12W-S-10P	2050261000
SAIL-M12BG-S-1.5P	2050160150
SAIL-M12BG-S-3.0P	2050160300
SAIL-M12BG-S-5.0P	2050160500
SAIL-M12BG-S-10P	2050161000
SAIL-M12BW-S-1.5P	2050210150
SAIL-M12BW-S-3.0P	2050210300
SAIL-M12BW-S-5.0P	2050210500
SAIL-M12BW-S-10P	2050211000

Technical data

Rated current	12 A
Protection degree	IP67, when screwed in
Core cross-section	1.5 mm <sup>2</sup>
Contact surface	Gold-plated
Temperature range of housing	-30...+90 °C
Rated voltage	600 V
Approvals	

Dimensioned drawing

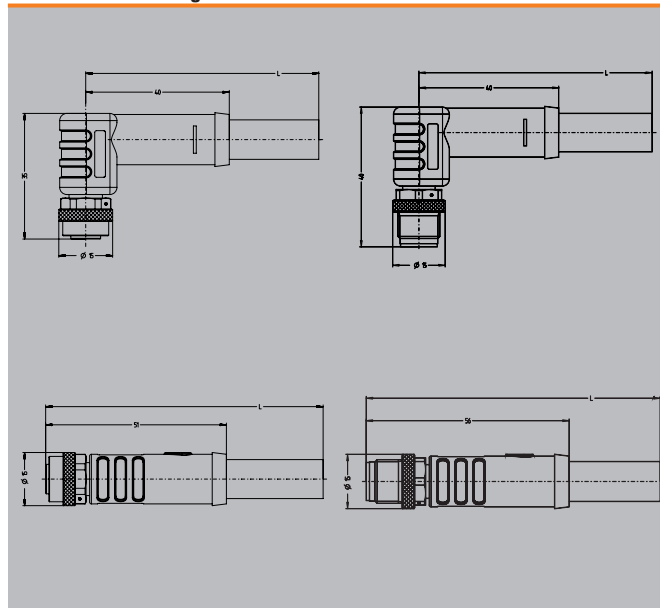

Technical data

Machinery

Process

Energy

Transportation

Device Manufacturers

Infrastructure





Connecting cables

M12

S-coded

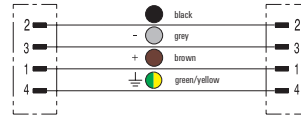
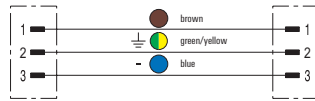
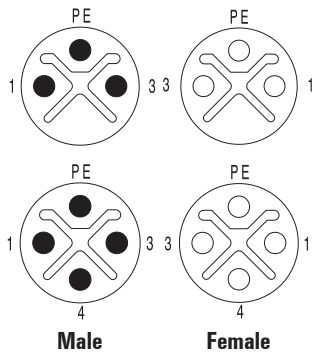

Ordering data

Male, straight - Female, straight	
PUR halogen-free	1.5 m
PUR halogen-free	3.0 m
PUR halogen-free	5.0 m
PUR halogen-free	10.0 m
Male, straight - Female, angled	
PUR halogen-free	1.5 m
PUR halogen-free	3.0 m
PUR halogen-free	5.0 m
PUR halogen-free	10.0 m
Male, angled - Female, angled	
PUR halogen-free	1.5 m
PUR halogen-free	3.0 m
PUR halogen-free	5.0 m
PUR halogen-free	10.0 m
Male, angled - female, straight	
PUR halogen-free	1.5 m
PUR halogen-free	3.0 m
PUR halogen-free	5.0 m
PUR halogen-free	10.0 m
Note	

3-pole	
SAIL-M12GM12G-S3-1.5P	2050060150
SAIL-M12GM12G-S3-3.0P	2050060300
SAIL-M12GM12G-S3-5.0P	2050060500
SAIL-M12GM12G-S3-10P	2050061000
3-pole	
SAIL-M12GM12W-S3-1.5P	2050100150
SAIL-M12GM12W-S3-3.0P	2050100300
SAIL-M12GM12W-S3-5.0P	2050100500
SAIL-M12GM12W-S3-10P	2050101000
3-pole	
SAIL-M12WM12W-S3-1.5P	2050150150
SAIL-M12WM12W-S3-3.0P	2050150300
SAIL-M12WM12W-S3-5.0P	2050150500
SAIL-M12WM12W-S3-10P	2050151000
3-pole	
SAIL-M12WM12G-S3-1.5P	2050080150
SAIL-M12WM12G-S3-3.0P	2050080300
SAIL-M12WM12G-S3-5.0P	2050080500
SAIL-M12WM12G-S3-10P	2050081000

4-pole	
SAIL-M12GM12G-S-1.5P	2050270150
SAIL-M12GM12G-S-3.0P	2050270300
SAIL-M12GM12G-S-5.0P	2050270500
SAIL-M12GM12G-S-10P	2050271000
4-pole	
SAIL-M12GM12W-S-1.5P	2050460150
SAIL-M12GM12W-S-3.0P	2050460300
SAIL-M12GM12W-S-5.0P	2050460500
SAIL-M12GM12W-S-10P	2050461000
4-pole	
SAIL-M12WM12W-S-1.5P	2050470150
SAIL-M12WM12W-S-3.0P	2050470300
SAIL-M12WM12W-S-5.0P	2050470500
SAIL-M12WM12W-S-10P	2050471000
4-pole	
SAIL-M12WM12G-S-1.5P	2050350150
SAIL-M12WM12G-S-3.0P	2050350300
SAIL-M12WM12G-S-5.0P	2050350500
SAIL-M12WM12G-S-10P	2050351000

Technical data

Rated current	12 A
Protection degree	IP67, when screwed in
Core cross-section	1.5 mm <sup>2</sup>
Contact surface	Gold-plated
Temperature range of housing	-30...+90 °C
Rated voltage	600 V
Approvals	

Dimensioned drawing

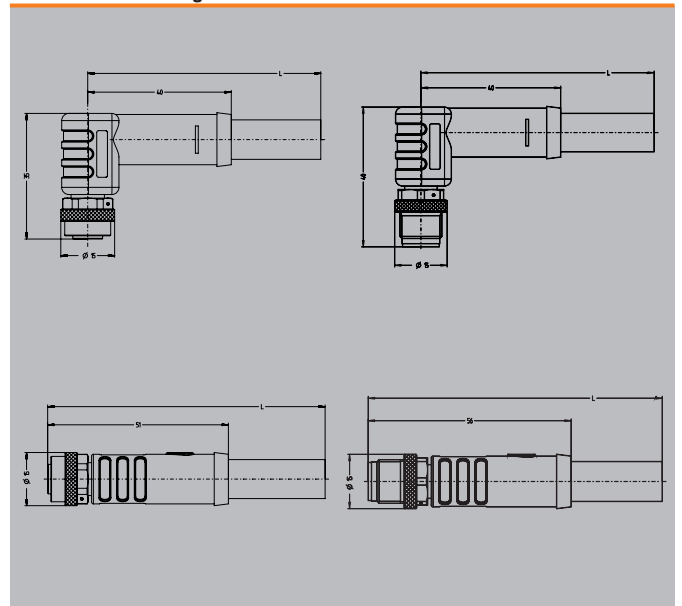

One end without connector  
M12  
T-coded

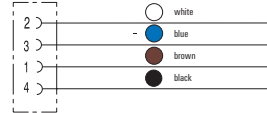
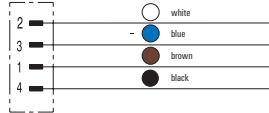
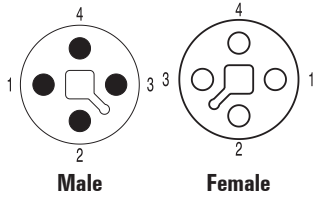

Ordering data

Male, straight	
PUR halogen-free	1.5 m
PUR halogen-free	3.0 m
PUR halogen-free	5.0 m
PUR halogen-free	10.0 m
Male, angled	
PUR halogen-free	1.5 m
PUR halogen-free	3.0 m
PUR halogen-free	5.0 m
PUR halogen-free	10.0 m
Female, straight	
PUR halogen-free	1.5 m
PUR halogen-free	3.0 m
PUR halogen-free	5.0 m
PUR halogen-free	10.0 m
Female, angled	
PUR halogen-free	1.5 m
PUR halogen-free	3.0 m
PUR halogen-free	5.0 m
PUR halogen-free	10.0 m
Note	

1.5 mm <sup>2</sup>	
SAIL-M12G-T-1.5P	2050640150
SAIL-M12G-T-3.0P	2050640300
SAIL-M12G-T-5.0P	2050640500
SAIL-M12G-T-10P	2050641000
1.5 mm <sup>2</sup>	
SAIL-M12W-T-1.5P	2050650150
SAIL-M12W-T-3.0P	2050650300
SAIL-M12W-T-5.0P	2050650500
SAIL-M12W-T-10P	2050651000
1.5 mm <sup>2</sup>	
SAIL-M12BG-T-1.5P	2050490150
SAIL-M12BG-T-3.0P	2050490300
SAIL-M12BG-T-5.0P	2050490500
SAIL-M12BG-T-10P	2050491000
1.5 mm <sup>2</sup>	
SAIL-M12BW-T-1.5P	2050560150
SAIL-M12BW-T-3.0P	2050560300
SAIL-M12BW-T-5.0P	2050560500
SAIL-M12BW-T-10P	2050561000

2.5 mm <sup>2</sup>	
SAIL-M12G-T-1.5H	2050700150
SAIL-M12G-T-3.0H	2050700300
SAIL-M12G-T-5.0H	2050700500
SAIL-M12G-T-10H	2050701000
2.5 mm <sup>2</sup>	
SAIL-M12W-T-1.5H	2050710150
SAIL-M12W-T-3.0H	2050710300
SAIL-M12W-T-5.0H	2050710500
SAIL-M12W-T-10H	2050711000
2.5 mm <sup>2</sup>	
SAIL-M12BG-T-1.5H	2050680150
SAIL-M12BG-T-3.0H	2050680300
SAIL-M12BG-T-5.0H	2050680500
SAIL-M12BG-T-10H	2050681000
2.5 mm <sup>2</sup>	
SAIL-M12BW-T-1.5H	2050690150
SAIL-M12BW-T-3.0H	2050690300
SAIL-M12BW-T-5.0H	2050690500
SAIL-M12BW-T-10H	2050691000

Technical data

Rated current	12 A
Protection degree	IP67, when screwed in
Core cross-section	1.5 mm
Contact surface	Gold-plated
Temperature range of housing	-30...+90 °C
Rated voltage	63 V
Approvals	

Dimensioned drawing

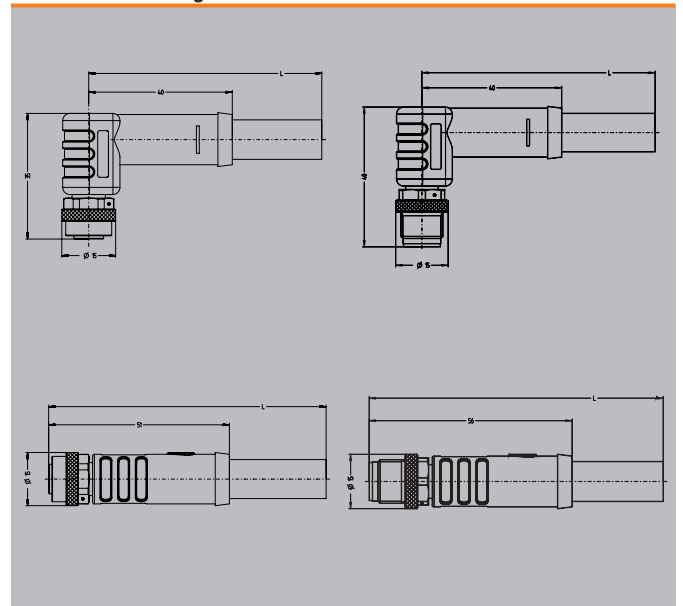

Technical data

Machinery

Process

Energy

Transportation

Device  
Manufacturers

Infrastructure



**Connecting cables**  
**M12**  
**T-coded**

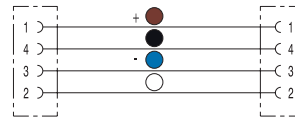
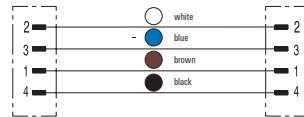
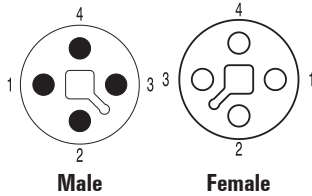

**Ordering data**

Male, straight - Female, straight	
PUR halogen-free	1.5 m
PUR halogen-free	3.0 m
PUR halogen-free	5.0 m
PUR halogen-free	10.0 m
Male, straight - Female, angled	
PUR halogen-free	1.5 m
PUR halogen-free	3.0 m
PUR halogen-free	5.0 m
PUR halogen-free	10.0 m
Male, angled - Female, angled	
PUR halogen-free	1.5 m
PUR halogen-free	3.0 m
PUR halogen-free	5.0 m
PUR halogen-free	10.0 m
Male, angled - female, straight	
PUR halogen-free	1.5 m
PUR halogen-free	3.0 m
PUR halogen-free	5.0 m
PUR halogen-free	10.0 m
Note	

1.5 mm <sup>2</sup>	
SAIL-M12GM12G-T-1.5P	2050760150
SAIL-M12GM12G-T-3.0P	2050760300
SAIL-M12GM12G-T-5.0P	2050760500
SAIL-M12GM12G-T-10P	2050761000
1.5 mm <sup>2</sup>	
SAIL-M12GM12W-T-1.5P	2050830150
SAIL-M12GM12W-T-3.0P	2050830300
SAIL-M12GM12W-T-5.0P	2050830500
SAIL-M12GM12W-T-10P	2050831000
1.5 mm <sup>2</sup>	
SAIL-M12WM12W-T-1.5P	2050860150
SAIL-M12WM12W-T-3.0P	2050860300
SAIL-M12WM12W-T-5.0P	2050860500
SAIL-M12WM12W-T-10P	2050861000
1.5 mm <sup>2</sup>	
SAIL-M12WM12G-T-1.5P	2050820150
SAIL-M12WM12G-T-3.0P	2050820300
SAIL-M12WM12G-T-5.0P	2050820500
SAIL-M12WM12G-T-10P	2050821000

2.5 mm <sup>2</sup>	
SAIL-M12GM12G-T-1.5H	2050870150
SAIL-M12GM12G-T-3.0H	2050870300
SAIL-M12GM12G-T-5.0H	2050870500
SAIL-M12GM12G-T-10H	2050871000
2.5 mm <sup>2</sup>	
SAIL-M12GM12W-T-1.5H	2050910150
SAIL-M12GM12W-T-3.0H	2050910300
SAIL-M12GM12W-T-5.0H	2050910500
SAIL-M12GM12W-T-10H	2050911000
2.5 mm <sup>2</sup>	
SAIL-M12WM12W-T-1.5H	2050920150
SAIL-M12WM12W-T-3.0H	2050920300
SAIL-M12WM12W-T-5.0H	2050920500
SAIL-M12WM12W-T-10H	2050921000
2.5 mm <sup>2</sup>	
SAIL-M12WM12G-T-1.5H	2050890150
SAIL-M12WM12G-T-3.0H	2050890300
SAIL-M12WM12G-T-5.0H	2050890500
SAIL-M12WM12G-T-10H	2050891000

**Technical data**

Rated current	12 A
Protection degree	IP67, when screwed in
Core cross-section	1.5 mm
Contact surface	Gold-plated
Temperature range of housing	-30...+90 °C
Rated voltage	63 V
Approvals	

**Dimensioned drawing**

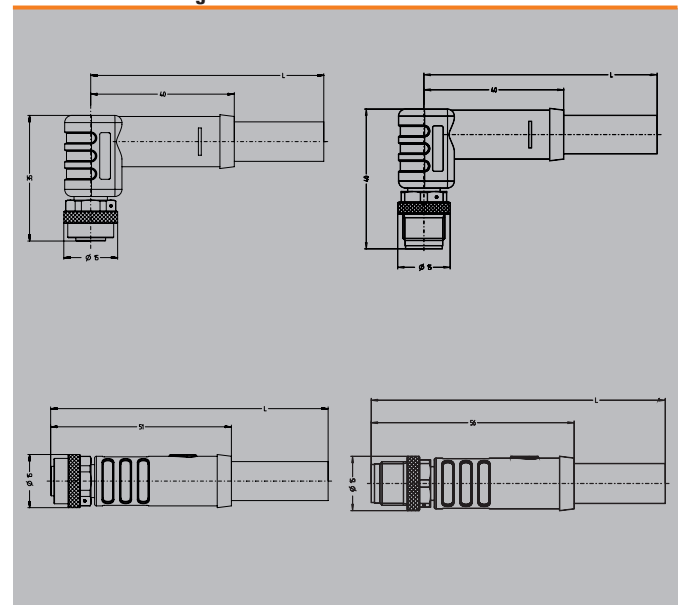

## FrontCom® Vario

### Double frame

- IP65
- One double insert plate or two single insert plates are mountable (additional partition necessary)

### Metal cover

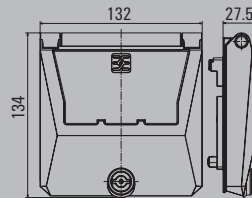

### Technical data

Protection degree / Protection class (UL)  
 Material cover  
 Material frame  
 Ambient temperature (operational)  
 Approvals

IP65, in closed state / Type 12  
 Zinc diecast, powder-coated  
 Zinc diecast  
 -40 °C...70 °C

#### Note

### Ordering data

button operation  
 Lockable with key  
 Lockable with cabinet key  
 Lockable with cabinet key (Daimler-Locking)

Type	Qty.	Order No.
IE-FC-DFM-KNOB	1	2003170000
IE-FC-DFM-KEY	1	2003180000
IE-FC-DFM-CAB	1	2003190000
IE-FC-DFM-CAB-DB	1	2003150000

#### Note

### Accessories

#### Spare key

Type	Qty.	Order No.
IE-FC-KEY	1	1465930000

#### Markers

silver  
 light grey  
 white  
 for touch-safe protection and insert plates

SM 27/18 K MC NE SI	80	1713760000
SM 27/18 K MC NE GR	80	1073340000
SM 27/18 K MC NE WS	80	1707270000
ESG 7/20 SIRIUS MC NE WS	200	1736181044

#### Touch-safe protection

Touch-safe protection

IE-FC-PWPC	1	1450820000
------------	---	------------

#### Bar (for mounting single insert plates)

Partition

IE-FC-DF-IPH	1	2003340000
--------------	---	------------

#### Note

Technical data

Machinery

Process

Energy

Transportation

Device  
Manufacturers

Infrastructure

**FrontCom® Vario****Insert plates for double frames**

- IP20

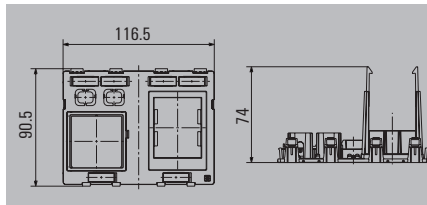
**1 x power, 2 x data, 1 x LS switch****Technical data**

Material  
Insert, data  
Insert Power large  
Preparation of LS switch (2 pitch)  
Insert 2 x Power US + GFCI  
Ambient temperature (operational)  
Approvals

**Note**

Polycarbonate PC  
2  
1  
1  
-40 °C...70 °C

**Ordering data**

shielded  
unshielded

**Note**

Type	Qty.	Order No.
IE-FC-DSP-PWB/2ST/FILS	1	2067080000
IE-FC-DIP-PWB/2ST/FILS	1	2067070000

**Accessories****Inserts, Power**

Socket AU 15 A  
Socket AU 10 A  
Socket CH  
Socket CN  
Socket GB  
Socket DE  
Socket DE orange  
Socket FR  
Socket FR orange  
Socket IT/EU  
Socket CZ  
Socket IND  
RCBO

Type	Qty.	Order No.
IE-FCI-PWB-AU	1	1450830000
IE-FCI-PWB-AU-10A	1	1546590000
IE-FCI-PWB-CH	1	1450780000
IE-FCI-PWB-CN	1	1450790000
IE-FCI-PWB-GB	1	1450770000
IE-FCI-PWB-DE	1	1450730000
IE-FCI-PWB-DE-OR	1	1554000000
IE-FCI-PWB-FR	1	1450750000
IE-FCI-PWB-FR-OR	1	2007230000
IE-FCI-PWB-IT	1	1450810000
IE-FCI-PWB-CZ	1	2426700000
IE-FCI-PWB-IND	1	2500710000
IE-FCI-PWB-RCBO	1	1534250000

**Inserts, Data**

RJ45 coupling  
RJ45 module EIA/TIA T568 B  
RJ45 module PROFINET  
RJ45 module EIA/TIA T568 A  
USB 2.0 A / A  
USB 3.0 A / A  
USB 2.0 A / B

IE-BI-RJ45-C	10	1962840000
IE-BI-RJ45-FJ-B	10	1963840000
IE-BI-RJ45-FJ-P	10	1963830000
IE-BI-RJ45-FJ-A	10	1962850000
IE-BI-USB-A	10	1019570000
IE-BI-USB-3.0-A	10	1487920000
IE-BI-USB-AB	10	1131380000

**Markers**

for touch-safe protection and insert plates

**Touch-safe protection**

Touch-safe protection

ESG 7/20 SIRIUS MC NE WS	200	1736181044
IE-FC-PWPC	1	1450820000

**Note**

**FrontCom® Vario**

**Insert plates for double frames**

- IP20

**1x GFCI, 2x data, 1x signal, 1x fuse**

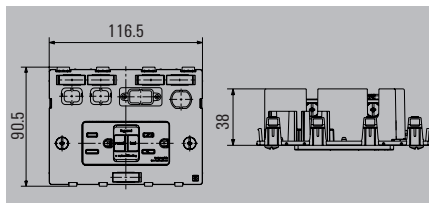

**Technical data**

Material
Insert, data
Insert Power large
Insert fuse
Signal insert D-Sub 9-pole / VGA / HDMI
Preparation of LS switch (2 TE)
Insert 2 x Power US + GFCI
Ambient temperature (operational)
Approvals

Polycarbonate PC
2
1
1
1
-35 °C...66 °C

**Technical data GFCI insert**

Operating voltage / Rated current
GFCI protected US outlet
Self-test
Status indication
Type of connection
Line connection cross-section
finely stranded with wire-end ferrule
finely stranded with wire-end ferrule
Conductor connection cross-section, solid

125 V AC / 20 A
2 pieces
automatically every 3 seconds
red LED
Screw connection
1.5 ... 2.5 mm <sup>2</sup>
1.5 ... 2.5 mm <sup>2</sup>
1.5 ... 4 mm <sup>2</sup>

**Note**

--

**Ordering data**

shielded
unshielded

**Note**

Type	Qty.	Order No.
IE-FC-DSP-CI/3A/2ST/1D9	1	2004810000
IE-FC-DIP-CI/3A/2ST/1D9	1	2003370000

incl. pre-mounted GFCI

**Accessories**

<b>Inserts, Signal</b>
D-Sub, 9-pole, female/female
D-Sub, 9-pole, female / male
D-Sub, 9-pole, female / solder connection
<b>Fuse inserts</b>
3 A
<b>Inserts, Data</b>
RJ45 coupling
RJ45 module EIA/TIA T568 A
RJ45 module EIA/TIA T568 B
RJ45 module PROFINET
USB 2.0 A / A
USB 3.0 A / A
USB 2.0 A / B
<b>Markers</b>
for touch-safe protection and insert plates

Type	Qty.	Order No.
IE-FCI-D9-FF	1	1450840000
IE-FCI-D9-FM	1	1450850000
IE-FCI-D9-FS	1	1450870000
IE-FCI-PWCB-3A	1	1543690000
IE-BI-RJ45-C	10	1962840000
IE-BI-RJ45-FJ-A	10	1962850000
IE-BI-RJ45-FJ-B	10	1963840000
IE-BI-RJ45-FJ-P	10	1963830000
IE-BI-USB-A	10	1019570000
IE-BI-USB-3.0-A	10	1487920000
IE-BI-USB-AB	10	1131380000

ESG 7/20 SIRIUS MC NE WS
200
1736181044

**Note**

--

Technical data

Machinery

Process

Energy

Transportation

Device Manufacturers

Infrastructure

**FrontCom® Vario**

**Insert plates**

- IP20

**blank double plate**

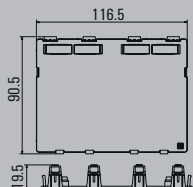

**blank single plate**

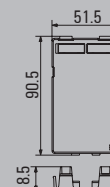

**Technical data**

Material	
Ambient temperature (operational)	
Approvals	
<b>Note</b>	

Material	Polycarbonate PC
Ambient temperature (operational)	-40 °C...70 °C
Approvals	
<b>Note</b>	

Material	Polycarbonate PC
Ambient temperature (operational)	-40 °C...70 °C
Approvals	CURUS; GERMLLOYD
<b>Note</b>	

**Ordering data**

	unshielded
<b>Note</b>	

Type	Qty.	Order No.
IE-FC-DIP-BP	1	<b>2004890000</b>

Type	Qty.	Order No.
IE-FC-IP-BP	1	<b>1450710000</b>

**Accessories**

Type	Qty.	Order No.

Type	Qty.	Order No.

Type	Qty.	Order No.

<b>Note</b>	
-------------	--

<b>Note</b>	
-------------	--

<b>Note</b>	
-------------	--

Technical data

Machinery

Process

Energy

Transportation

Device Manufacturers

Infrastructure

FrontCom® Vario

Insert plates

- IP20

1 x power, 2 x data

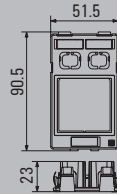

1x Power, 2x Data, 1x Signal

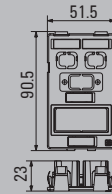

Technical data

Material
Insert, data
Signal insert D-Sub 9-pole / VGA / HDMI
Insert, signal, D-Sub, 25-pole
Insert Power large
Insert Power small
Insert Power US
Ambient temperature (operational)
Approvals
<b>Note</b>

Polycarbonate PC
2
1
1
-40 °C...70 °C
CURUS; GERMLLOYD

Polycarbonate PC
2
1
1
-40 °C...70 °C
CURUS; GERMLLOYD

Ordering data

shielded
unshielded
<b>Note</b>

Type	Qty.	Order No.
IE-FC-SP-PWB/2ST	1	1450550000
IE-FC-IP-PWB/2ST	1	1450630000

Type	Qty.	Order No.
IE-FC-SP-PWS/2ST/1D9	1	1450600000
IE-FC-IP-PWS/2ST/1D9	1	1450690000

Accessories

Inserts, Power	
Socket AU 15 A	
Socket AU 10 A	
Socket CH	
Socket CN	
Socket GB	
Socket DE	
Socket DE orange	
Socket FR	
Socket FR orange	
Socket IT/EU	
Socket CZ	
Socket IND	
RCBO	
Inserts, Data	
RJ45 coupling	
RJ45 module EIA/TIA T568 B	
RJ45 module PROFINET	
RJ45 module EIA/TIA T568 A	
USB 2.0 A / A	
USB 3.0 A / A	
USB 2.0 A / B	
Markers	
for touch-safe protection and insert plates	
Touch-safe protection	
Touch-safe protection	
Inserts, Signal	
D-Sub, 9-pole, female/female	
D-Sub, 9-pole, female / male	
D-Sub, 9-pole, female / solder connection	
<b>Note</b>	

Type	Qty.	Order No.
IE-FCI-PWB-AU	1	1450830000
IE-FCI-PWB-AU-10A	1	1546590000
IE-FCI-PWB-CH	1	1450780000
IE-FCI-PWB-CN	1	1450790000
IE-FCI-PWB-GB	1	1450770000
IE-FCI-PWB-DE	1	1450730000
IE-FCI-PWB-DE-OR	1	1554000000
IE-FCI-PWB-FR	1	1450750000
IE-FCI-PWB-FR-OR	1	2007230000
IE-FCI-PWS-IT	1	1450810000
IE-FCI-PWB-CZ	1	2426700000
IE-FCI-PWB-IND	1	2500710000
IE-FCI-PWB-RCBO	1	1534250000
IE-BI-RJ45-C	10	1962840000
IE-BI-RJ45-FJ-B	10	1963840000
IE-BI-RJ45-FJ-P	10	1963830000
IE-BI-RJ45-FJ-A	10	1962850000
IE-BI-USB-A	10	1019570000
IE-BI-USB-3.0-A	10	1487920000
IE-BI-USB-AB	10	1131380000
ESG 7/20 SIRIUS MC NE WS	200	1736181044
IE-FC-PWPC	1	1450820000
IE-FCI-D9-FF	1	1450840000
IE-FCI-D9-FM	1	1450850000
IE-FCI-D9-FS	1	1450870000

Type	Qty.	Order No.
IE-FCI-PWS-IT	1	1450810000
IE-BI-RJ45-C	10	1962840000
IE-BI-RJ45-FJ-B	10	1963840000
IE-BI-RJ45-FJ-P	10	1963830000
IE-BI-RJ45-FJ-A	10	1962850000
IE-BI-USB-A	10	1019570000
IE-BI-USB-3.0-A	10	1487920000
IE-BI-USB-AB	10	1131380000
ESG 7/20 SIRIUS MC NE WS	200	1736181044
IE-FC-PWPC	1	1450820000
IE-FCI-D9-FF	1	1450840000
IE-FCI-D9-FM	1	1450850000
IE-FCI-D9-FS	1	1450870000

Technical data

Machinery

Process

Energy

Transportation

Device Manufacturers

Infrastructure



**FrontCom® Vario**

**Insert plates**

- IP20

**1 x power, 4 x data**

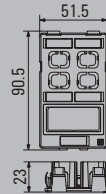

**1 x power, 2 x signal**

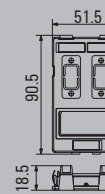

**Technical data**

Material
Insert, data
Signal insert D-Sub 9-pole / VGA / HDMI
Insert, signal, D-Sub, 25-pole
Insert Power large
Insert Power small
Insert Power US
Ambient temperature (operational)
Approvals
<b>Note</b>

Polycarbonate PC
4
1
-40 °C...70 °C
CURUS; GERMLLOYD

Polycarbonate PC
2
1
-40 °C...70 °C
CURUS; GERMLLOYD

**Ordering data**

	shielded
	unshielded
<b>Note</b>	

Type	Qty.	Order No.
IE-FC-SP-PWS/4ST	1	1450570000
IE-FC-IP-PWS/4ST	1	1450640000

Type	Qty.	Order No.
IE-FC-SP-PWS/2D9	1	1450610000
IE-FC-IP-PWS/2D9	1	1450680000

**Accessories**

<b>Inserts, Power</b>	Socket IT/EU
<b>Inserts, Data</b>	RJ45 coupling
	RJ45 module EIA/TIA T568 A
	RJ45 module EIA/TIA T568 B
	RJ45 module PROFINET
	USB 2.0 A / A
	USB 3.0 A / A
	USB 2.0 A / B
<b>Markers</b>	for touch-safe protection and insert plates
<b>Touch-safe protection</b>	Touch-safe protection
<b>Inserts, Signal</b>	D-Sub, 9-pole, female/female
	D-Sub, 9-pole, female / male
	D-Sub, 9-pole, female / solder connection

Type	Qty.	Order No.
IE-FCI-PWS-IT	1	1450810000
IE-BI-RJ45-C	10	1962840000
IE-BI-RJ45-FJ-A	10	1962850000
IE-BI-RJ45-FJ-B	10	1963840000
IE-BI-RJ45-FJ-P	10	1963830000
IE-BI-USB-A	10	1019570000
IE-BI-USB-3.0-A	10	1487920000
IE-BI-USB-AB	10	1131380000
ESG 7/20 SIRIUS MC NE WS	200	1736181044
IE-FC-PWPC	1	1450820000

Type	Qty.	Order No.
IE-FCI-PWS-IT	1	1450810000
ESG 7/20 SIRIUS MC NE WS	200	1736181044
IE-FC-PWPC	1	1450820000
IE-FCI-D9-FF	1	1450840000
IE-FCI-D9-FM	1	1450850000
IE-FCI-D9-FS	1	1450870000

<b>Note</b>
-------------

--

--

Technical data

Machinery



Process



Energy



Transportation



Device Manufacturers



Infrastructure



FrontCom® Vario

Insert plates

- IP20

1 x power, 2 x data

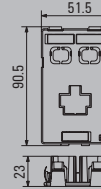

1 x power, 1 x 3A fuse, 1 x data

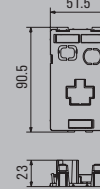

Technical data

Material
Insert, data
Signal insert D-Sub 9-pole / VGA / HDMI
Insert, signal, D-Sub, 25-pole
Insert Power large
Insert Power small
Insert Power US
Insert fuse
Ambient temperature (operational)
Approvals
<b>Note</b>

Polycarbonate PC
2
1
-40 °C...70 °C
CURUS; GERMLLOYD

Polycarbonate PC
1
1
-40 °C...70 °C

Ordering data

shielded
unshielded
<b>Note</b>

Type	Qty.	Order No.
IE-FC-SP-PWU/2ST	1	1450620000
IE-FC-IP-PWU/2ST	1	1450700000
For US socket the touch-safe protection is mandatory		

Type	Qty.	Order No.
IE-FC-IP-PWU/1ST/CB	1	1543710000
Touch-safe protection is obligatory when using the US socket		

Accessories

Inserts, Signal	
D-Sub, 9-pole, female/female	
D-Sub, 9-pole, female / male	
D-Sub, 9-pole, female / solder connection	
D-Sub, 25-pole, female/female	
D-Sub, 25-pole, female/male	
D-Sub, 25-pole, female / solder connection	
Inserts, Data	
RJ45 coupling	
RJ45 module EIA/TIA T568 A	
RJ45 module EIA/TIA T568 B	
RJ45 module PROFINET	
USB 2.0 A / A	
USB 3.0 A / A	
USB 2.0 A / B	
Markers	
for touch-safe protection and insert plates	
Touch-safe protection	
Touch-safe protection	
Inserts, Power	
Fuse inserts	
3 A	
<b>Note</b>	

Type	Qty.	Order No.
IE-BI-RJ45-C	10	1962840000
IE-BI-RJ45-FJ-A	10	1962850000
IE-BI-RJ45-FJ-B	10	1963840000
IE-BI-RJ45-FJ-P	10	1963830000
IE-BI-USB-A	10	1019570000
IE-BI-USB-3.0-A	10	1487920000
IE-BI-USB-AB	10	1131380000
ESG 7/20 SIRIUS MC NE WS	200	1736181044
IE-FC-PWPC	1	1450820000
IE-FCI-PWS-US	1	1450800000

Type	Qty.	Order No.
IE-BI-RJ45-C	10	1962840000
IE-BI-RJ45-FJ-A	10	1962850000
IE-BI-RJ45-FJ-B	10	1963840000
IE-BI-RJ45-FJ-P	10	1963830000
IE-BI-USB-A	10	1019570000
IE-BI-USB-3.0-A	10	1487920000
IE-BI-USB-AB	10	1131380000
ESG 7/20 SIRIUS MC NE WS	200	1736181044
IE-FC-PWPC	1	1450820000
IE-FCI-PWS-US	1	1450800000
IE-FCI-PWCB-3A	1	1543690000
<b>Note</b>		

Technical data  
Machinery  
Process  
Energy  
Transportation  
Device Manufacturers  
Infrastructure

## FrontCom® Vario

### Insert plates

- IP20

### 2 x data, 2 x signal

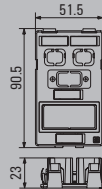

### 1 x data, 2 x signal

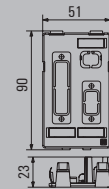

### Technical data

Material  
Insert, data  
Signal insert D-Sub 9-pole / VGA / HDMI  
Insert, signal, D-Sub, 25-pole  
Insert Power large  
Insert Power small  
Insert Power US  
Insert fuse  
Ambient temperature (operational)  
Approvals

#### Note

Polycarbonate PC  
2  
2  
  
-40 °C...70 °C  
CURUS; GERMLLOYD

Polycarbonate PC  
1  
1  
1  
  
-40 °C...70 °C  
CURUS; GERMLLOYD

### Ordering data

shielded  
unshielded

#### Note

Type	Qty.	Order No.
IE-FC-SP-2ST/2D9	1	1450590000
IE-FC-IP-2ST/2D9	1	1450670000

Type	Qty.	Order No.
IE-FC-SP-1ST/1D9/1D25	1	1450580000
IE-FC-IP-1ST/1D9/1D25	1	1450650000

### Accessories

#### Inserts, Signal

D-Sub, 9-pole, female/female  
D-Sub, 9-pole, female / male  
D-Sub, 9-pole, female / solder connection  
D-Sub, 25-pole, female/female  
D-Sub, 25-pole, female/male  
D-Sub, 25-pole, female / solder connection

#### Inserts, Data

RJ45 coupling  
RJ45 module EIA/TIA T568 A  
RJ45 module EIA/TIA T568 B  
RJ45 module PROFINET  
USB 2.0 A / A  
USB 3.0 A / A  
USB 2.0 A / B

#### Markers

for touch-safe protection and insert plates

#### Touch-safe protection

Touch-safe protection

#### Inserts, Power

#### Fuse inserts

3 A

Type	Qty.	Order No.
IE-FCI-D9-FF	1	1450840000
IE-FCI-D9-FM	1	1450850000
IE-FCI-D9-FS	1	1450870000
IE-BI-RJ45-C	10	1962840000
IE-BI-RJ45-FJ-A	10	1962850000
IE-BI-RJ45-FJ-B	10	1963840000
IE-BI-RJ45-FJ-P	10	1963830000
IE-BI-USB-A	10	1019570000
IE-BI-USB-3.0-A	10	1487920000
IE-BI-USB-AB	10	1131380000

Type	Qty.	Order No.
IE-FCI-D9-FF	1	1450840000
IE-FCI-D9-FM	1	1450850000
IE-FCI-D9-FS	1	1450870000
IE-FCI-D25-FM	1	1450890000
IE-FCI-D25-FS	1	1450900000
IE-FCI-D25-FF	1	1450880000
IE-BI-RJ45-C	10	1962840000
IE-BI-RJ45-FJ-A	10	1962850000
IE-BI-RJ45-FJ-B	10	1963840000
IE-BI-RJ45-FJ-P	10	1963830000
IE-BI-USB-A	10	1019570000
IE-BI-USB-3.0-A	10	1487920000
IE-BI-USB-AB	10	1131380000

#### Note



Technical data  
Machinery  
Process  
Energy  
Transportation  
Device Manufacturers  
Infrastructure

**Data inserts**

**RJ45**

- Cat. 6<sub>A</sub>
- IP20
- For housing variants 1, 4, 5, 14 and for FrontCom®

**Module**

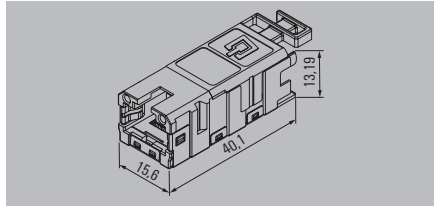

**Technical data**

Protection degree
Plugging cycles
Shielding
Housing main material
Contact surface
Connection cross-section, flexible, min. / max.
Connection cross-section, solid, min. / max.
Insulation diameter, min. / max.
Connector standard
Ambient temperature (operational)
PoE / PoE+
Approvals
<b>Note</b>

IP67 with housing
750
360° all-round enclosure
Zinc diecast
Gold over nickel, Au ≥ 0.8 μm
AWG 26 / AWG 22
AWG 24 / AWG 22
0.85 mm...1.6 mm
IEC 60603-7-51
-40 °C...70 °C
conforming to IEEE 802.3af
CULUS

**Ordering data**

tool-free	
	TIA-A. Cat. 6 <sub>A</sub>
	TIA-B. Cat. 6 <sub>A</sub>
	PROFINET Cat. 5
	Coupling
<b>Note</b>	

Type	Qty.	Order No.
IE-BI-RJ45-FJ-A	10	1962850000
IE-BI-RJ45-FJ-B	10	1963840000
IE-BI-RJ45-FJ-P	10	1963830000

**Accessories**

Tools
Optional pressing tool

Type	Qty.	Order No.
PWZ RJ45	1	1118040000

<b>Note</b>
-------------

**Coupling**

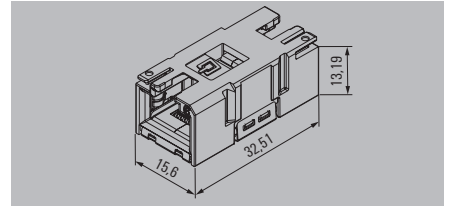

IP67 with housing
750
360° all-round enclosure
Zinc diecast
Gold over nickel, Au ≥ 0.8 μm
IEC 60603-7-51
-40 °C...70 °C
conforming to IEEE 802.3af
CULUS; GERMLLOYD

Type	Qty.	Order No.
IE-BI-RJ45-C	10	1962840000

Type	Qty.	Order No.

<b>Note</b>
-------------

**Data inserts**  
**USB**

- Cat. 6<sub>A</sub>
- IP20
- For housing variants 1, 4, 5, 14 and for FrontCom®

**Coupling USB A/A**

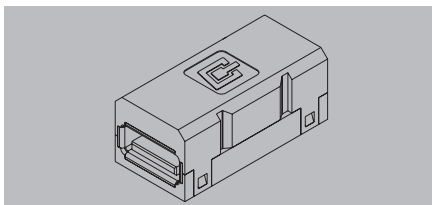

**Coupling USB A/B**

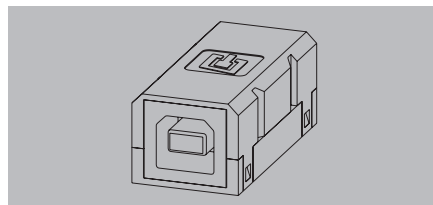

**Technical data**

Protection degree  
Shielding  
Ambient temperature (operational)  
Connection 1 / 2  
Connector standard  
Approvals

**Note**

IP67 with housing  
360° all-round enclosure  
-40 °C...70 °C  
USB A / USB A  
IEC 61076-3-107  
GERMLLOYD

IP67 with housing  
360° all-round enclosure  
-40 °C...70 °C  
USB A / USB B  
IEC 61076-3-107  
GERMLLOYD

**Ordering data**

	USB 2.0
	USB 3.0

**Note**

Type	Qty.	Order No.
IE-BI-USB-A	10	1019570000
IE-BI-USB-3.0-A	10	1487920000

Type	Qty.	Order No.
IE-BI-USB-AB	10	1131380000

**Accessories**

Type	Qty.	Order No.

Type	Qty.	Order No.

**Note**

Technical data

Machinery



Process



Energy



Transportation



Device Manufacturers



Infrastructure



Signal inserts

D-sub

- IP20

9-pole

25-pole

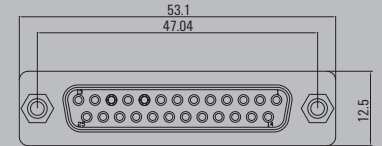
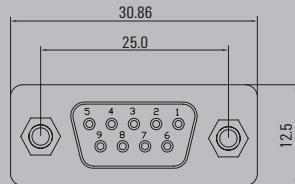
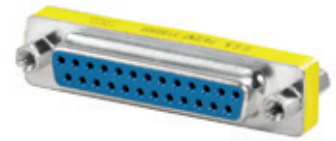

Technical data

Protection degree	IP20
Housing main material	SPCC
No. of poles	9
Housing surface	tin-plated
Material insulator	PBT glass fibre reinforced UL 94 V-0
Contact surface	Gold-plated
Contact resistance	≤ 20 mΩ
Insulation resistance	1000 MΩ at 500 V DC
Dielectric strength, contact / contact	1 kV <sub>eff</sub> / 1 min.
Ambient temperature (operational)	-55 °C...105 °C
Approvals	GERMLLOYD
Note	

Protection degree	IP20
Housing main material	SPCC
No. of poles	25
Housing surface	tin-plated
Material insulator	PBT glass fibre reinforced UL 94 V-0
Contact surface	Gold-plated
Contact resistance	≤ 20 mΩ
Insulation resistance	1000 MΩ at 500 V DC
Dielectric strength, contact / contact	1 kV <sub>eff</sub> / 1 min.
Ambient temperature (operational)	-55 °C...105 °C
Approvals	GERMLLOYD
Note	

Protection degree	IP20
Housing main material	SPCC
No. of poles	25
Housing surface	tin-plated
Material insulator	PBT glass fibre reinforced UL 94 V-0
Contact surface	Gold-plated
Contact resistance	≤ 20 mΩ
Insulation resistance	1000 MΩ at 500 V DC
Dielectric strength, contact / contact	1 kV <sub>eff</sub> / 1 min.
Ambient temperature (operational)	-55 °C...105 °C
Approvals	GERMLLOYD
Note	

Ordering data

Socket / socket
Socket / plug
Socket / solder connection
Note

Type	Qty.	Order No.
IE-FCI-D9-FF	1	1450840000
IE-FCI-D9-FM	1	1450850000
IE-FCI-D9-FS	1	1450870000

Type	Qty.	Order No.
IE-FCI-D25-FF	1	1450880000
IE-FCI-D25-FM	1	1450890000
IE-FCI-D25-FS	1	1450900000

Accessories

Type	Qty.	Order No.
------	------	-----------

Type	Qty.	Order No.
------	------	-----------

Type	Qty.	Order No.
------	------	-----------

Note
------

Note
------

Note
------

Technical data

Machinery

Process

Energy

Transportation

Device Manufacturers

Infrastructure

Signal inserts

- IP20

HDMI



HD15 / VGA

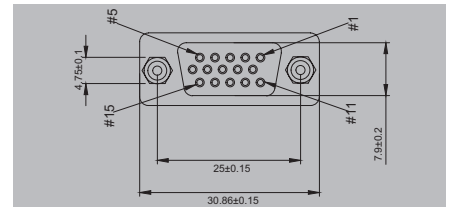

Technical data

Protection degree
Housing main material
No. of poles
Housing surface
Contact surface
Contact resistance
Insulation resistance
Dielectric strength, contact / contact
Ambient temperature (operational)
Approvals
<b>Note</b>

IP20
PVC casting
9
Gold-plated
-15 °C...50 °C

IP20
25
Gold over nickel
1000 MΩ at 500 V DC
1000 V <sub>eff</sub> / 1 min
-55 °C...105 °C
GERMLLOYD

Ordering data

<b>Note</b>

Type	Qty.	Order No.
IE-FCHDMI-FF	1	2003390000

Type	Qty.	Order No.
IE-FCHD15-FF	1	1556290000

Accessories

--

Type	Qty.	Order No.

Type	Qty.	Order No.

<b>Note</b>
-------------

--

--

Technical data

Machinery



Process



Energy



Transportation



Device Manufacturers



Infrastructure



**Power inserts**

**Power sockets**

- IP20

**Germany, white**

**Germany, orange**

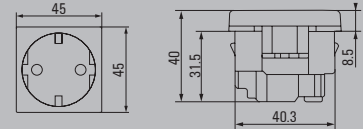
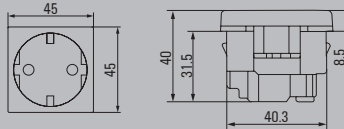

**Technical data**

Protection degree	IP20
Housing main material	Polycarbonate PC
Type of connection	PUSH IN
Line connection cross-section	1.5 ... 1.5 mm <sup>2</sup>
finely stranded with wire-end ferrule	1.5 ... 2.5 mm <sup>2</sup>
finely stranded without wire-end ferrule	1.5 ... 1.5 mm <sup>2</sup>
finely stranded with wire-end ferrule	1.5 ... 2.5 mm <sup>2</sup>
finely stranded without wire-end ferrule	1.5 ... 2.5 mm <sup>2</sup>
Conductor connection cross-section, solid	1.5 ... 2.5 mm <sup>2</sup>
Stripping length	10 mm
Rated voltage (AC)	250 V
Rated current	16 A
Ambient temperature (operational)	-5 °C...50 °C
Approvals	GERMLLOYD
<b>Note</b>	

Protection degree	IP20
Housing main material	Polycarbonate PC
Type of connection	PUSH IN
Line connection cross-section	1.5 ... 1.5 mm <sup>2</sup>
finely stranded with wire-end ferrule	1.5 ... 2.5 mm <sup>2</sup>
finely stranded without wire-end ferrule	1.5 ... 1.5 mm <sup>2</sup>
finely stranded with wire-end ferrule	1.5 ... 2.5 mm <sup>2</sup>
finely stranded without wire-end ferrule	1.5 ... 2.5 mm <sup>2</sup>
Conductor connection cross-section, solid	1.5 ... 2.5 mm <sup>2</sup>
Stripping length	10 mm
Rated voltage (AC)	250 V
Rated current	16 A
Ambient temperature (operational)	-5 °C...50 °C
Approvals	GERMLLOYD
<b>Note</b>	

Protection degree	IP20
Housing main material	Polycarbonate PC
Type of connection	PUSH IN
Line connection cross-section	1.5 ... 1.5 mm <sup>2</sup>
finely stranded with wire-end ferrule	1.5 ... 2.5 mm <sup>2</sup>
finely stranded without wire-end ferrule	1.5 ... 1.5 mm <sup>2</sup>
finely stranded with wire-end ferrule	1.5 ... 2.5 mm <sup>2</sup>
finely stranded without wire-end ferrule	1.5 ... 2.5 mm <sup>2</sup>
Conductor connection cross-section, solid	1.5 ... 2.5 mm <sup>2</sup>
Stripping length	10 mm
Rated voltage (AC)	250 V
Rated current	16 A
Ambient temperature (operational)	-5 °C...50 °C
Approvals	GERMLLOYD
<b>Note</b>	

**Ordering data**

Type	Qty.	Order No.
IE-FCI-PWB-DE	1	1450730000
<b>Note</b>		

Type	Qty.	Order No.
IE-FCI-PWB-DE	1	1450730000
<b>Note</b>		

Type	Qty.	Order No.
IE-FCI-PWB-DE-OR	1	1554000000
<b>Note</b>		

**Accessories**

Type	Qty.	Order No.
<b>Note</b>		

Type	Qty.	Order No.
<b>Note</b>		

Type	Qty.	Order No.
<b>Note</b>		

<b>Note</b>
-------------

<b>Note</b>
-------------

<b>Note</b>
-------------

Technical data

Machinery

Process

Energy

Transportation

Device Manufacturers

Infrastructure



Switzerland

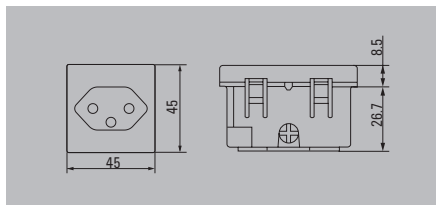

IP20
Polycarbonate PC
PUSH IN
1.5 ... 1.5 mm <sup>2</sup>
1.5 ... 2.5 mm <sup>2</sup>
1.5 ... 1.5 mm <sup>2</sup>
1.5 ... 2.5 mm <sup>2</sup>
1.5 ... 2.5 mm <sup>2</sup>
10 mm
250 V
10 A
-5 °C...50 °C
GERMLLOYD

Type	Qty.	Order No.
IE-FCI-PWB-CH	1	1450780000

Type	Qty.	Order No.

France, white

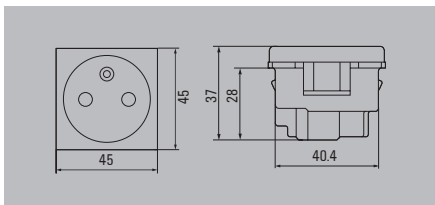

IP20
Polycarbonate PC
PUSH IN
1.5 ... 1.5 mm <sup>2</sup>
1.5 ... 2.5 mm <sup>2</sup>
1.5 ... 1.5 mm <sup>2</sup>
1.5 ... 2.5 mm <sup>2</sup>
1.5 ... 2.5 mm <sup>2</sup>
10 mm
250 V
16 A
-5 °C...50 °C
GERMLLOYD

Type	Qty.	Order No.
IE-FCI-PWB-FR	1	1450750000

Type	Qty.	Order No.

France, orange

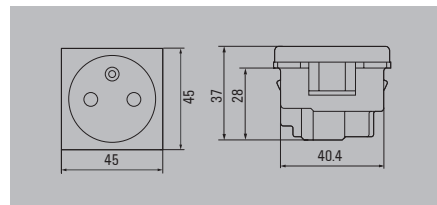

IP20
Polycarbonate PC
PUSH IN
1.5 ... 1.5 mm <sup>2</sup>
1.5 ... 2.5 mm <sup>2</sup>
1.5 ... 1.5 mm <sup>2</sup>
1.5 ... 2.5 mm <sup>2</sup>
1.5 ... 2.5 mm <sup>2</sup>
10 mm
250 V
16 A
-5 °C...50 °C

Type	Qty.	Order No.
IE-FCI-PWB-FR-OR	1	2007230000

Type	Qty.	Order No.

Technical data

Machinery

Process

Energy

Transportation

Device Manufacturers

Infrastructure

**Power inserts**  
**Power sockets**

- IP20

**UK**

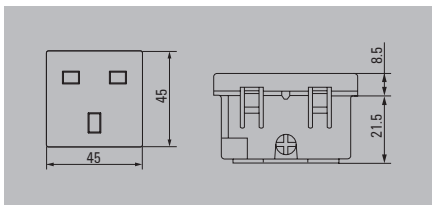

**Italy / Europe**

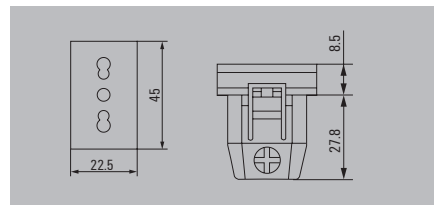

**Technical data**

Protection degree	IP20
Housing main material	Polycarbonate PC
Type of connection	Screw connection
Line connection cross-section	1.5 ... 2.5 mm <sup>2</sup>
finely stranded with wire-end ferrule	1.5 ... 4 mm <sup>2</sup>
finely stranded without wire-end ferrule	1.5 ... 2.5 mm <sup>2</sup>
finely stranded with wire-end ferrule	1.5 ... 4 mm <sup>2</sup>
finely stranded without wire-end ferrule	1.5 ... 4 mm <sup>2</sup>
Conductor connection cross-section, solid	1.5 ... 4 mm <sup>2</sup>
Stripping length	9 mm
Rated voltage (AC)	250 V
Rated current	13 A
Ambient temperature (operational)	-5 °C...50 °C
Approvals	GERMLLOYD
<b>Note</b>	

Protection degree	IP20
Housing main material	Polycarbonate PC
Type of connection	Screw connection
Line connection cross-section	1.5 ... 2.5 mm <sup>2</sup>
finely stranded with wire-end ferrule	1.5 ... 4 mm <sup>2</sup>
finely stranded without wire-end ferrule	1.5 ... 2.5 mm <sup>2</sup>
finely stranded with wire-end ferrule	1.5 ... 4 mm <sup>2</sup>
finely stranded without wire-end ferrule	1.5 ... 4 mm <sup>2</sup>
Conductor connection cross-section, solid	1.5 ... 4 mm <sup>2</sup>
Stripping length	9 mm
Rated voltage (AC)	250 V
Rated current	16 A
Ambient temperature (operational)	-5 °C...50 °C
Approvals	GERMLLOYD
<b>Note</b>	

Protection degree	IP20
Housing main material	Polycarbonate PC
Type of connection	Screw connection
Line connection cross-section	1.5 ... 2.5 mm <sup>2</sup>
finely stranded with wire-end ferrule	1.5 ... 4 mm <sup>2</sup>
finely stranded without wire-end ferrule	1.5 ... 2.5 mm <sup>2</sup>
finely stranded with wire-end ferrule	1.5 ... 4 mm <sup>2</sup>
finely stranded without wire-end ferrule	1.5 ... 4 mm <sup>2</sup>
Conductor connection cross-section, solid	1.5 ... 4 mm <sup>2</sup>
Stripping length	9 mm
Rated voltage (AC)	250 V
Rated current	16 A
Ambient temperature (operational)	-5 °C...50 °C
Approvals	GERMLLOYD
<b>Note</b>	

**Ordering data**

Type	Qty.	Order No.
IE-FCI-PWB-GB	1	1450770000
<b>Note</b>		

Type	Qty.	Order No.
IE-FCI-PWS-IT	1	1450810000
<b>Note</b>		

Type	Qty.	Order No.
IE-FCI-PWS-IT	1	1450810000
<b>Note</b>		

**Accessories**

Type	Qty.	Order No.
<b>Note</b>		

Type	Qty.	Order No.
<b>Note</b>		

Type	Qty.	Order No.
<b>Note</b>		

<b>Note</b>
-------------

<b>Note</b>
-------------

<b>Note</b>
-------------

Czech Republic

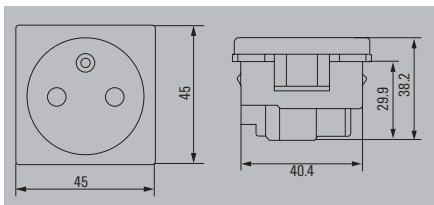

IP20
Polycarbonate PC
PUSH IN
1.5 ... 1.5 mm <sup>2</sup>
1.5 ... 2.5 mm <sup>2</sup>
1.5 ... 1.5 mm <sup>2</sup>
1.5 ... 2.5 mm <sup>2</sup>
1.5 ... 2.5 mm <sup>2</sup>
12 mm
250 V
16 A
-5 °C...50 °C

Type	Qty.	Order No.
IE-FCI-PWB-CZ	1	2426700000

Type	Qty.	Order No.

Australia, 15 A

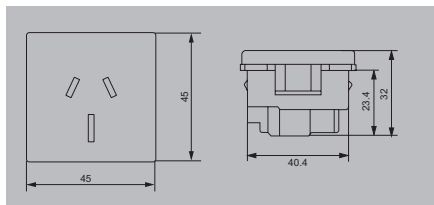

IP20
Polycarbonate PC
Screw connection
1.5 ... 2.5 mm <sup>2</sup>
1.5 ... 4 mm <sup>2</sup>
1.5 ... 2.5 mm <sup>2</sup>
1.5 ... 4 mm <sup>2</sup>
1.5 ... 4 mm <sup>2</sup>
9 mm
240 V
15 A
-5 °C...50 °C
GERMLLOYD

Type	Qty.	Order No.
IE-FCI-PWB-AU	1	1450830000

Type	Qty.	Order No.

Australia, 10 A

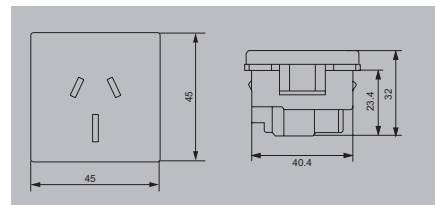

IP20
Polycarbonate PC
Screw connection
1.5 ... 2.5 mm <sup>2</sup>
1.5 ... 4 mm <sup>2</sup>
1.5 ... 2.5 mm <sup>2</sup>
1.5 ... 4 mm <sup>2</sup>
1.5 ... 4 mm <sup>2</sup>
9 mm
240 V
10 A
-5 °C...50 °C
GERMLLOYD

Type	Qty.	Order No.
IE-FCI-PWB-AU-10A	1	1546590000

Type	Qty.	Order No.

Technical data

Machinery

Process

Energy

Transportation

Device Manufacturers

Infrastructure

**Power inserts**  
**Power sockets**

- IP20

**China**

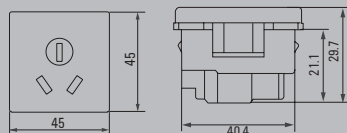

**USA**

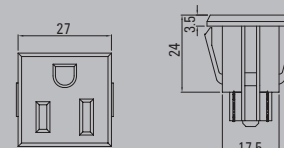

**Technical data**

Protection degree  
Housing main material  
Type of connection  
Line connection cross-section  
    finely stranded with wire-end ferrule  
    finely stranded without wire-end ferrule  
    finely stranded with wire-end ferrule  
    finely stranded without wire-end ferrule  
Conductor connection cross-section, solid  
Stripping length  
Rated voltage (AC)  
Rated current  
Ambient temperature (operational)  
Approvals

IP20  
Polycarbonate PC  
Screw connection

1.5 ... 2.5 mm<sup>2</sup>  
1.5 ... 4 mm<sup>2</sup>  
1.5 ... 2.5 mm<sup>2</sup>  
1.5 ... 4 mm<sup>2</sup>

1.5 ... 4 mm<sup>2</sup>  
9 mm  
250 V  
10 A  
-5 °C...50 °C  
GERMLLOYD

IP20  
PA 66  
Solder connection, FS 4.8 x 0.8

125 V  
15 A  
-20 °C...85 °C  
GERMLLOYD; UR

**Note**

**Ordering data**

**Note**

**Accessories**

Type	Qty.	Order No.
IE-FCI-PWB-CN	1	1450790000

Type	Qty.	Order No.
------	------	-----------

Type	Qty.	Order No.
IE-FCI-PWS-US	1	1450800000

For US socket the touch-safe protection is mandatory

Type	Qty.	Order No.
VFSKHV/1,5-2,5/485	100	1491920000

**Note**

Technical data

Machinery

Process

Energy

Transportation

Device  
Manufacturers

Infrastructure

India

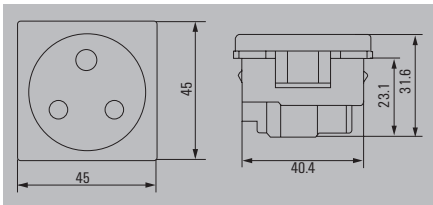

IP20
Polycarbonate PC
Screw connection
1.5 ... 2.5 mm <sup>2</sup>
1.5 ... 2.5 mm <sup>2</sup>
1.5 ... 4 mm <sup>2</sup>
9 mm
250 V
13 A
-5 °C...50 °C

Type	Qty.	Order No.
IE-FCI-PWB-IND	1	2500710000

Type	Qty.	Order No.



Technical data

Machinery

Process

Energy

Transportation

Device  
Manufacturers

Infrastructure

**Power inserts**

**RCBO**

- IP20

**RCBO**

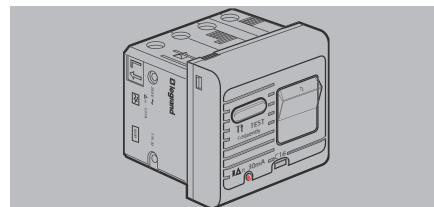

**Technical data**

Ambient temperature (operational)
Operating voltage
Rated current
I $\Delta$ m
I $\Delta$ n
Triggering characteristic
Type of connection
Line connection cross-section
finely stranded with wire-end ferrule
finely stranded with wire-end ferrule
Conductor connection cross-section, solid
<b>Note</b>

-5 °C...40 °C
230 V AC
16 A
500 A
30 mA
Typ C
Screw connection
1.5 ... 2.5 mm <sup>2</sup>
1.5 ... 2.5 mm <sup>2</sup>
1.5 ... 2.5 mm <sup>2</sup>

**Ordering data**

<b>Note</b>
-------------

Type	Qty.	Order No.
IE-FCI-PWB-RCBO	1	1534250000

**Accessories**

--

Type	Qty.	Order No.

<b>Note</b>
-------------

--

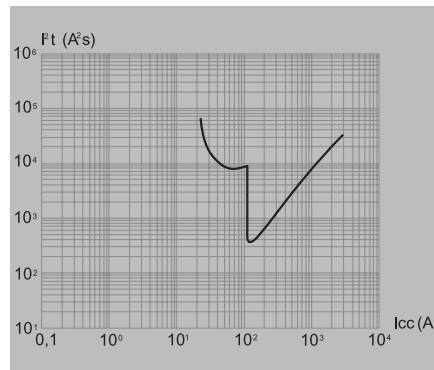

**Power inserts**  
**USB charge insert**

- IP20

**USB-Charger 5 V / 2.4 A**

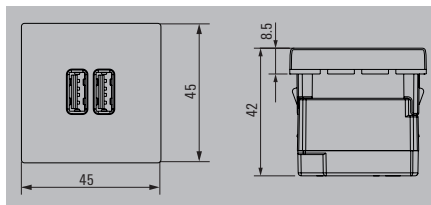

**Technical data**

Ambient temperature (operational)  
Input voltage  
Frequency range  
Input current  
Output voltage  
Output current  
Degree of efficiency  
Power consumption in standby mode  
Standards  
Class of protection  
Housing main material  
Type of connection  
Line connection cross-section  
    finely stranded with wire-end ferrule  
    finely stranded with wire-end ferrule  
Conductor connection cross-section, solid  
Stripping length

0 °C...45 °C  
220...240 V AC  
50...60 Hz  
≤ 300 mA  
5 V DC  
2.4 A  
81 %  
max. 0.1 W  
EN 60950-1, EN 62684, EN 50558  
II  
Polycarbonate PC  
Screw connection  
1.5 ... 2.5 mm<sup>2</sup>  
1.5 ... 2.5 mm<sup>2</sup>  
1.5 ... 2.5 mm<sup>2</sup>  
6 mm

Note

**Ordering data**

Type	Qty.	Order No.
IE-FCI-PWB-2USB-A-5V	1	2505070000

Note

**Accessories**

Type	Qty.	Order No.
------	------	-----------

Note

Technical data

Machinery



Process



Energy



Transportation



Device  
Manufacturers



Infrastructure



Technical data

Machinery

Process

Energy

Transportation

Device  
Manufacturers

Infrastructure

### 3A fuse

- IP20

### 3A fuse

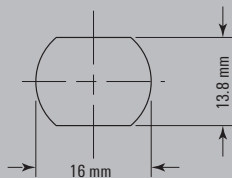

#### Technical data

Operating voltage  
Rated current  
Type of connection

32 V DC, 250 V AC  
3 A  
Flat-blade receptacles 6.5 mm

#### Note

#### Ordering data

#### Note

Type	Qty.	Order No.
IE-FC-PWCB-3A	1	1543690000

#### Accessories

Flat blade connector, 6.5 mm	
	angled
	straight

Type	Qty.	Order No.
WFSKHV/1,5-2,5	100	1491970000
VFSKHV/1,5-2,5/638	100	1491940000

#### Note



Technical data

Machinery



Process



Energy



Transportation



Device  
Manufacturers



Infrastructure



Plug PushPull Power

Plug Power 24 V

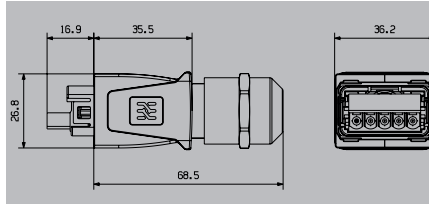

Technical data

General data

Protection degree  
 Connector standard  
 Ambient temperature (operational)  
 No. of poles  
 Wire connection cross-section, flexible, min./max.  
 Sheath diameter, min. / max.  
 Connection  
 Approvals

IP65, IP67  
 in accordance with PROFINET specification  
 -40 °C...70 °C  
 5  
 0.75 mm<sup>2</sup> / 2.5 mm<sup>2</sup>  
 6 mm / 13 mm  
 Tension clamp

Material properties

Housing base material  
 Sealing material  
 Cable sealing material  
 Contact material / Contact surface  
 UL 94 flammability rating  
 Pollution severity level  
 Plugging cycles

Zinc diecast, nickel-plated  
 NBR  
 EPDM  
 Copper alloy / Gold over nickel  
 V-2  
 2  
 ≥ 100

Electrical properties\*

Current-carrying capacity at 50 °C  
 Rated voltage

16 A  
 24 V

Note

Ordering data - Sets

Note

Type	Qty.	Order No.
IE-PS-VAPM-5P-2.5	1	2465440000

Ordering data - Empty housings

Note

Type	Qty.	Order No.

Note

## Flanges PushPull Power

## Flange Power 24 V



**PROFI**  
**NET**

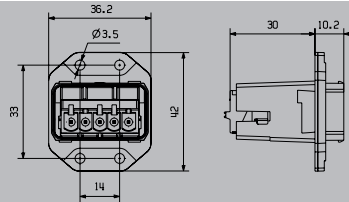

## Technical data

## General data

Protection degree  
Connector standard  
Ambient temperature (operational)  
No. of poles  
Connection diameter, flexible, min. / max.  
Connection 1  
Approvals  
Installation

IP67  
in accordance with PROFINET specification  
-40 °C...70 °C  
5  
0.75 mm<sup>2</sup> / 2.5 mm<sup>2</sup>  
Tension clamp  
4 screws

## Material properties

Housing base material  
Sealing material  
Cable sealing material  
Contact carrier material  
Contact material / Contact surface  
UL 94 flammability rating  
Pollution severity level  
Plugging cycles

Zinc diecast, nickel-plated  
NBR  
EPDM  
PA  
Copper alloy / Gold over nickel  
V-2  
2  
≥ 100

## Electrical properties\*

Current-carrying capacity at 50 °C  
Rated voltage

16 A  
24 V

## Note

## Ordering data - Sets

## Note

Type	Qty.	Order No.
IE-BSS-VAPM-24V	1	2493480000

## Ordering data - Empty housings

Device flange

## Note

Type	Qty.	Order No.
IE-BHD-VAPM	1	2493490000

## Accessories

## Dust protection cap

IP54 protective cap  
Dust cap

Type	Qty.	Order No.
IE-BP-VAPP	10	1068930000
IE-BP-VAPP-DC	10	2494060000

## Note



## Weidmüller Industry Light

### WIL Standard

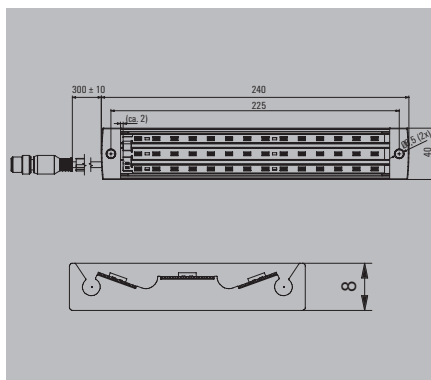

### Ordering data

	0.3 m cable length
<b>Note</b>	

### WIL Standard

Type	QTY	Order No.
WIL-STANDARD	1	2436210000

### Technical data

Light colour (CCT)	6500K
Rated voltage (acc. to VDE standard 0110 ISO Group C)	24 V DC ± 10%
Rated current	420 mA
Illumination level	140 lux ± 10 lux at 1 m and 24 V
Operating life	10.000 h
L x W x H	225 / 40 / 8 mm
Housing main material	hard anodised aluminium
Material of end caps	Nickel-plated CuZn
Number of LEDs	52
Cable length	0.3 m
Wiring	M12: Pin 4 = connecting wire, Pin 3 = earth
Cable Material	TPE
Threaded ring material	PA
Protection degree	IP67

### Dimensioned drawing

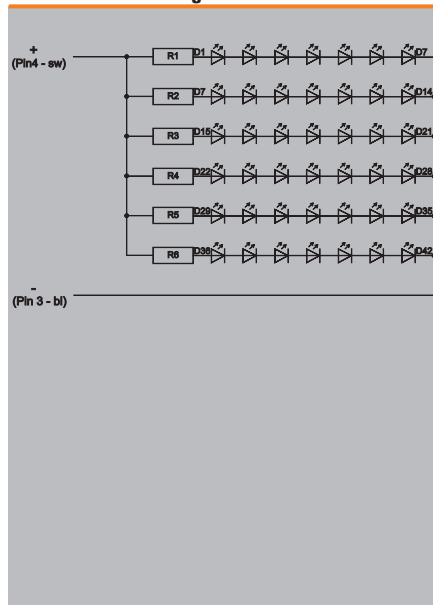



Infrastructure



Device  
Manufacturers



Transportation



Energy



Process



Machinery

Technical data

LUF 10.00/./90V

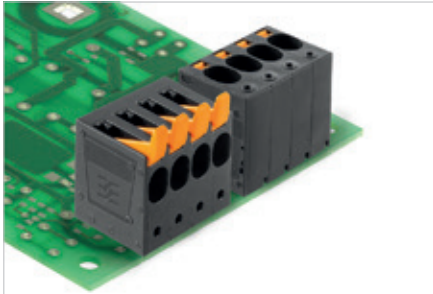

High-performance PCB terminal block with PUSH IN connection technology for conductor cross-sections up to 16 mm<sup>2</sup>.

- Fast connection without tools thanks to an operating lever to open the contact point, or direct plug-in method
- Securely closed contact point; with the „Connection Safety Concept“ means the conductor is always clamped securely
- Integrated test point for PS 2.0 test plug
- Central tip test point for test probes on the upper side of the terminal
- Increased derating reserves because WEMID insulating material is used
- Wire outlet direction of 90°

Product data

IEC: 1000 V / 76 A / 0.5 - 16 mm<sup>2</sup>  
 UL: 600 V / 58 A / AWG 20 - 4



For additional articles and information, refer to [catalog.weidmueller.com](http://catalog.weidmueller.com)

Note:

- Additional colours on request
- Rated current related to rated cross-section & min. No. of poles.
- Wire end ferrule without plastic collar to DIN 46228/1
- Wire end ferrule with plastic collar to DIN 46228/4
- P on drawing = pitch
- Rated data refer only to the component itself. Clearance and creepage distances to other components are to be designed in accordance with the relevant application standards.
- The test point can only be used as potential-pickup point.

Technical data

In compliance with IEC 60664-1 / IEC 61984			
Clamping range, max.	mm <sup>2</sup>	0.5...16	
<b>Solid core H05(07) V-U</b>	<b>mm<sup>2</sup></b>	<b>0.5...16</b>	
Stranded H07 V-R	mm <sup>2</sup>	6...16	
Flexible H05(07) V-K	mm <sup>2</sup>	0.5...16	
Flexible with ferrule	mm <sup>2</sup>	0.5...16	
Ferrule with plastic collar	mm <sup>2</sup>	0.5...16	
Stripping length	mm	18	
Screwdriver blade	mm	0.8 x 4.0	
According to norm			
Tightening torque range			
<b>Rated current, max.</b>	<b>A</b>	<b>76</b>	<b>76</b>
At ambient temperature		20°C	40°C
For conductor cross-section			
Overtoltage category		III	III II
Pollution severity		3	2 2
<b>Rated voltage</b>	<b>V</b>	<b>1000</b>	<b>1000 1000</b>
Rated impulse voltage	kV	8	8 8
<b>UL / CUL (Use Group)</b>	<b>B C D</b>	<b>B</b>	<b>C D</b>
<b>Rated voltage</b>	<b>V</b>	<b>600</b>	<b>600 600</b>
<b>Rated current</b>	<b>A</b>	<b>58</b>	<b>58 5</b>
<b>AWG conductor</b>	<b>AWG</b>	<b>20-4</b>	
<b>CSA (Use Group)</b>	<b>B C D</b>	<b>B</b>	<b>C D</b>
Rated voltage	V	600	600 600
Rated current	A	58	58 5
AWG conductor	AWG	20-4	
<b>General data</b>			
Type of insulation material		Wemid (PA)	
UL 94 flammability rating		V-0	
Contact base material		E-Cu	
Material of contact surface			
Pin dimensions = d	mm	1.2, Octagonal	
Solder eyelet Ø = D	mm	1.6	
Solder eyelet Ø tolerance	mm	+ 0,1	

Accessories

Note: Refer to the Accessories chapter for additional accessories.

Screwdriver		Order No.
	SDIS 0.8X4.0X100	9008400000
	SDS 0.8X4.0X100	9008340000
Test plug		
	PS 2.0 MC	0310000000

LUF 10.00/./90V



Dimensioned drawing

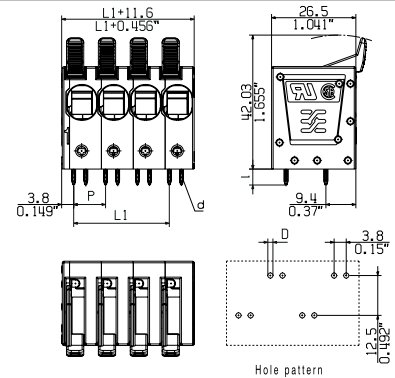

Ordering data

Solder pin length		5 mm		
Colour		Black		
Pitch		10.00 mm		
Pol.	L1	(inch)	Qty.	Order No.
2	10.00	0.394	40	2453690000
3	20.00	0.787	40	2453700000
4	30.00	1.181	30	2453710000
5	40.00	1.575	30	2453720000
6	50.00	1.969	25	2453730000
7	60.00	2.362	20	2453740000
8	70.00	2.756	10	2453750000
9	80.00	3.150	10	2453760000
10	90.00	3.543	1	2453770000
11	100.00	3.937	1	2453780000
12	110.00	4.331	1	2453790000



Infrastructure



Device  
Manufacturers



Transportation



Energy



Process



Machinery

Technical data

Technical data

Machinery

Process

Energy

Transportation

Device Manufacturers

Infrastructure

LUF5 10.00../180

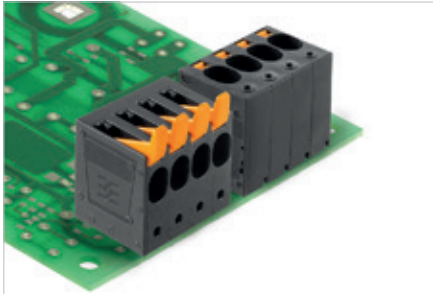

High-performance PCB terminal block with PUSH IN connection technology for conductor cross-sections up to 16 mm<sup>2</sup>.

- Fast connection thanks to pusher to open the contact point, or direct plug-in method
- Securely closed contact point; with the „Connection Safety Concept“ means the conductor is always clamped securely
- Integrated test point for PS 2.0 test plug
- Increased derating reserves because WEMID insulating material is used
- Wire outlet direction and activation in 180° version

preliminary Technical data

In compliance with IEC 60664-1 / IEC 61984			
Clamping range, max.	mm <sup>2</sup>	0.5...16	
<b>Solid core H05(07) V-U</b>	<b>mm<sup>2</sup></b>	<b>0.5...16</b>	
Stranded H07 V-R	mm <sup>2</sup>	6...16	
Flexible H05(07) V-K	mm <sup>2</sup>	0.5...16	
Flexible with ferrule	mm <sup>2</sup>	0.5...16	
Ferrule with plastic collar	mm <sup>2</sup>	0.5...16	
Stripping length	mm	18	
Screwdriver blade	mm	0.8 x 4.0	
According to norm			
Tightening torque range			
<b>Rated current, max.</b>	<b>A</b>	<b>76</b>	<b>76</b>
At ambient temperature		20°C	40°C
For conductor cross-section			
Overtoltage category		III	III II
Pollution severity		3	2 2
<b>Rated voltage</b>	<b>V</b>	<b>630</b>	<b>690 1000</b>
Rated impulse voltage	kV	6	6 6
<b>UL / CUL (Use Group)</b>		<b>B</b>	<b>C D</b>
<b>Rated voltage</b>	<b>V</b>	<b>300</b>	<b>150 600</b>
<b>Rated current</b>	<b>A</b>	<b>61</b>	<b>61 5</b>
<b>AWG conductor</b>	<b>AWG</b>		<b>20-4</b>
<b>CSA (Use Group)</b>		<b>B</b>	<b>C D</b>
Rated voltage	V	600	600 600
Rated current	A	58	58 5
AWG conductor	AWG		20-4
<b>General data</b>			
Type of insulation material		Wemid (PA)	
UL 94 flammability rating		V-0	
Contact base material		E-Cu	
Material of contact surface			
Pin dimensions = d	mm	1.2, Octagonal	
Solder eyelet Ø = D	mm	1.6	
Solder eyelet Ø tolerance	mm	+ 0,1	

Product data

IEC: 1000 V / 76 A / 0.5 - 16 mm<sup>2</sup>  
 UL: 300 V / 61 A / AWG 20 - 4



For additional articles and information, refer to [catalog.weidmuller.com](http://catalog.weidmuller.com)

Note:

- Additional colours on request
- Rated current related to rated cross-section & min. No. of poles.
- Wire end ferrule without plastic collar to DIN 46228/1
- Wire end ferrule with plastic collar to DIN 46228/4
- P on drawing = pitch
- Rated data refer only to the component itself. Clearance and creepage distances to other components are to be designed in accordance with the relevant application standards.
- The test point can only be used as potential-pickup point.

LUF5 10.00../180



Dimensioned drawing

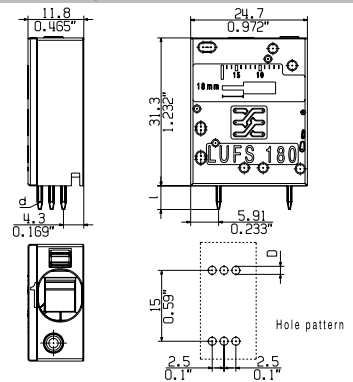

Accessories

Note: Refer to the Accessories chapter for additional accessories.

Screwdriver		Order No.
	SDIS 0.8X4.0X100	9008400000
	SDS 0.8X4.0X100	9008340000
Test plug		
	PS 2.0 MC	0310000000

Ordering data

Solder pin length		5 mm		
Colour		Black		
Pitch		10.00 mm		
Pol.	L1	(inch)	Qty.	Order No.
1	0.00	0.000	50	2491810000



LUFS 10.00/./180V



High-performance PCB terminal block with PUSH IN connection technology for conductor cross-sections up to 16 mm<sup>2</sup>.

- Fast connection thanks to pusher to open the contact point, or direct plug-in method
- Securely closed contact point; with the „Connection Safety Concept“ means the conductor is always clamped securely
- Integrated test point for PS 2.0 test plug
- Increased derating reserves because WEMID insulating material is used
- Wire outlet direction and activation in 180° version

preliminary Technical data

<b>In compliance with IEC 60664-1 / IEC 61984</b>			
Clamping range, max.	mm <sup>2</sup>	0.5...16	
<b>Solid core H05(07) V-U</b>	<b>mm<sup>2</sup></b>	<b>0.5...16</b>	
Stranded H07 V-R	mm <sup>2</sup>	6...16	
Flexible H05(07) V-K	mm <sup>2</sup>	0.5...16	
Flexible with ferrule	mm <sup>2</sup>	0.5...16	
Ferrule with plastic collar	mm <sup>2</sup>	0.5...16	
Stripping length	mm	18	
Screwdriver blade	mm	0.8 x 4.0	
According to norm			
Tightening torque range			
<b>Rated current, max.</b>	<b>A</b>	<b>76</b>	<b>76</b>
At ambient temperature		20°C	40°C
For conductor cross-section			
Overtoltage category		III	III II
Pollution severity		3	2 2
<b>Rated voltage</b>	<b>V</b>	<b>1000</b>	<b>1000 1000</b>
Rated impulse voltage	kV	8	8 8
<b>UL / CUL (Use Group)</b>		<b>B</b>	<b>C D</b>
<b>Rated voltage</b>	<b>V</b>	<b>600</b>	<b>600 600</b>
<b>Rated current</b>	<b>A</b>	<b>58</b>	<b>58 5</b>
<b>AWG conductor</b>	<b>AWG</b>	<b>20-4</b>	
<b>CSA (Use Group)</b>		<b>B</b>	<b>C D</b>
Rated voltage	V	600	600 600
Rated current	A	58	58 5
AWG conductor	AWG	20-4	
<b>General data</b>			
Type of insulation material		Wemid (PA)	
UL 94 flammability rating		V-0	
Contact base material		E-Cu	
Material of contact surface			
Pin dimensions = d	mm	1.2, Octagonal	
Solder eyelet Ø = D	mm	1.6	
Solder eyelet Ø tolerance	mm	+ 0,1	

Product data

IEC: 1000 V / 76 A / 0.5 - 16 mm<sup>2</sup>  
 UL: 600 V / 58 A / AWG 20 - 4



For additional articles and information, refer to [catalog.weidmuller.com](http://catalog.weidmuller.com)

Note:

- Additional colours on request
- Rated current related to rated cross-section & min. No. of poles.
- Wire end ferrule without plastic collar to DIN 46228/1
- Wire end ferrule with plastic collar to DIN 46228/4
- P on drawing = pitch
- Rated data refer only to the component itself. Clearance and creepage distances to other components are to be designed in accordance with the relevant application standards.
- The test point can only be used as potential-pickup point.

LUFS 10.00/./180V



Dimensioned drawing

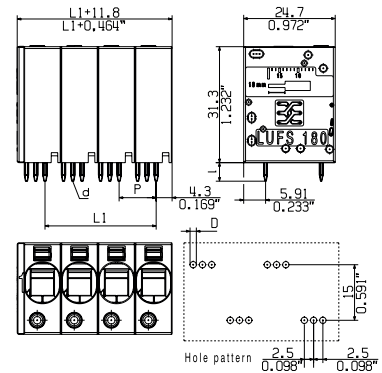

Accessories

Note: Refer to the Accessories chapter for additional accessories.

Screwdriver		Order No.
	SDIS 0.8X4.0X100	9008400000
	SDS 0.8X4.0X100	9008340000
Test plug		
	PS 2.0 MC	0310000000

Ordering data

Solder pin length		5 mm		
Colour		Black		
Pitch		10.00 mm		
Pol.	L1	(inch)	Qty.	Order No.
2	10.00	0.394	40	2492110000
3	20.00	0.787	40	2492120000
4	30.00	1.181	30	2492130000
5	40.00	1.575	25	2492140000
6	50.00	1.969	20	2492150000
7	60.00	2.362	10	2492160000
8	70.00	2.756	10	2492170000
9	80.00	3.150	10	2492180000
10	90.00	3.543	10	2492190000
11	100.00	3.937	10	2492200000
12	110.00	4.331	10	2492210000

Technical data

Machinery

Process

Energy

Transportation

Device Manufacturers

Infrastructure

LUF 15.00/..90

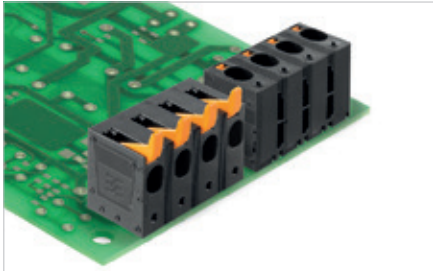

High-performance PCB terminal block with PUSH IN connection technology for conductor cross-sections up to 16 mm<sup>2</sup> in 15.00 mm pitch

- Fast connection thanks to pusher to open the contact point, or direct plug-in method
- Securely closed contact point; with the „Connection Safety Concept“ means the conductor is always clamped securely
- Integrated test point for PS 2.0 test plug
- Central tip test point for test probes on the upper side of the terminal
- Increased derating reserves because WEMID insulating material is used
- Wire outlet direction and activation in 90° version

preliminary Technical data

<b>In compliance with IEC 60664-1 / IEC 61984</b>			
Clamping range, max.	mm <sup>2</sup>	0.5...16	
<b>Solid core H05(07) V-U</b>	<b>mm<sup>2</sup></b>	<b>0.5...16</b>	
Stranded H07 V-R	mm <sup>2</sup>	6...16	
Flexible H05(07) V-K	mm <sup>2</sup>	0.5...16	
Flexible with ferrule	mm <sup>2</sup>	0.5...16	
Ferrule with plastic collar	mm <sup>2</sup>	0.5...16	
Stripping length	mm	18	
Screwdriver blade	mm	0.8 x 4.0	
According to norm			
Tightening torque range			
<b>Rated current, max.</b>	<b>A</b>	<b>76</b>	<b>76</b>
At ambient temperature		20°C	40°C
For conductor cross-section			
Overtoltage category		III	III II
Pollution severity		3	2 2
<b>Rated voltage</b>	<b>V</b>	<b>1000</b>	<b>1000 1000</b>
Rated impulse voltage	kV	8	8 8
<b>UL / CUL (Use Group)</b>	<b>B C D</b>	<b>B</b>	<b>C D</b>
<b>Rated voltage</b>	<b>V</b>	<b>600</b>	<b>600 600</b>
<b>Rated current</b>	<b>A</b>	<b>66</b>	<b>66 10</b>
<b>AWG conductor</b>	<b>AWG</b>	<b>20-4</b>	
<b>CSA (Use Group)</b>	<b>B C D</b>	<b>B</b>	<b>C D</b>
Rated voltage	V	600	600 600
Rated current	A	66	66 10
AWG conductor	AWG	20-4	
<b>General data</b>			
Type of insulation material		Wemid (PA)	
UL 94 flammability rating		V-0	
Contact base material		E-Cu	
Material of contact surface			
Pin dimensions = d	mm	1.2, Octagonal	
Solder eyelet Ø = D	mm	1.6	
Solder eyelet Ø tolerance	mm	+ 0,1	

Product data

IEC: 1000 V / 76 A / 0.5 - 16 mm<sup>2</sup>  
 UL: 600 V / 66 A / AWG 20 - 4



For additional articles and information, refer to [catalog.weidmuller.com](http://catalog.weidmuller.com)

Note:

- Additional colours on request
- Rated current related to rated cross-section & min. No. of poles.
- Wire end ferrule without plastic collar to DIN 46228/1
- Wire end ferrule with plastic collar to DIN 46228/4
- P on drawing = pitch
- Rated data refer only to the component itself. Clearance and creepage distances to other components are to be designed in accordance with the relevant application standards.
- The test point can only be used as potential-pickup point.

LUF 15.00/..90



Dimensioned drawing

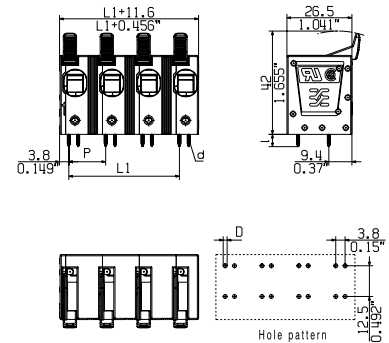

Accessories

Note: Refer to the Accessories chapter for additional accessories.

Screwdriver		Order No.
	SDIS 0.8X4.0X100	9008400000
	SDS 0.8X4.0X100	9008340000
Test plug		
	PS 2.0 MC	0310000000

Ordering data

Solder pin length		5 mm		
Colour		Black		
Pitch 15.00 mm				
Pol.	L1	(inch)	Qty.	Order No.
2	15.00	0.590	40	2491800000
3	30.00	1.181	40	2491900000
4	45.00	1.772	30	2491910000
5	60.00	2.362	25	2491920000
6	75.00	2.953	20	2491930000
7	90.00	3.543	10	2491940000
8	105.00	4.134	10	2491950000

LUF 15.00/./90V

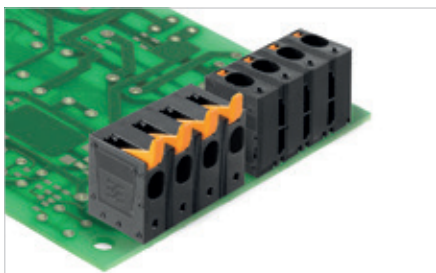

High-performance PCB terminal block with PUSH IN connection technology for conductor cross-sections up to 16 mm<sup>2</sup> in 15.00 mm pitch

- Fast connection without tools thanks to an operating lever to open the contact point, or direct plug-in method
- Securely closed contact point; with the „Connection Safety Concept“ means the conductor is always clamped securely
- Integrated test point for PS 2.0 test plug
- Central tip test point for test probes on the upper side of the terminal
- Increased derating reserves because WEMID insulating material is used
- Wire outlet direction of 90°

preliminary Technical data

In compliance with IEC 60664-1 / IEC 61984			
Clamping range, max.	mm <sup>2</sup>	0.5...16	
<b>Solid core H05(07) V-U</b>	<b>mm<sup>2</sup></b>	<b>0.5...16</b>	
Stranded H07 V-R	mm <sup>2</sup>	6...16	
Flexible H05(07) V-K	mm <sup>2</sup>	0.5...16	
Flexible with ferrule	mm <sup>2</sup>	0.5...16	
Ferrule with plastic collar	mm <sup>2</sup>	0.5...16	
Stripping length	mm	18	
Screwdriver blade	mm	0.8 x 4.0	
According to norm			
Tightening torque range			
<b>Rated current, max.</b>	<b>A</b>	<b>76</b>	<b>76</b>
At ambient temperature		20°C	40°C
For conductor cross-section		III	III
Overtoltage category		III	II
Pollution severity		3	2
<b>Rated voltage</b>	<b>V</b>	<b>1000</b>	<b>1000</b>
Rated impulse voltage	kV	8	8
<b>UL / CUL (Use Group)</b>		<b>B</b>	<b>C</b>
<b>Rated voltage</b>	<b>V</b>	<b>600</b>	<b>600</b>
<b>Rated current</b>	<b>A</b>	<b>66</b>	<b>66</b>
<b>AWG conductor</b>	<b>AWG</b>	<b>20-4</b>	
<b>CSA (Use Group)</b>		<b>B</b>	<b>C</b>
Rated voltage	V	600	600
Rated current	A	66	66
AWG conductor	AWG	20-4	
General data			
Type of insulation material		Wemid (PA)	
UL 94 flammability rating		V-0	
Contact base material		E-Cu	
Material of contact surface			
Pin dimensions = d	mm	1.2, Octagonal	
Solder eyelet Ø = D	mm	1.6	
Solder eyelet Ø tolerance	mm	+ 0,1	

Product data

IEC: 1000 V / 76 A / 0.5 - 16 mm<sup>2</sup>  
 UL: 600 V / 66 A / AWG 20 - 4



For additional articles and information, refer to [catalog.weidmueller.com](http://catalog.weidmueller.com)

Note:

- Additional colours on request
- Rated current related to rated cross-section & min. No. of poles.
- Wire end ferrule without plastic collar to DIN 46228/1
- Wire end ferrule with plastic collar to DIN 46228/4
- P on drawing = pitch
- Rated data refer only to the component itself. Clearance and creepage distances to other components are to be designed in accordance with the relevant application standards.
- The test point can only be used as potential-pickup point.

LUF 15.00/./90V



Dimensioned drawing

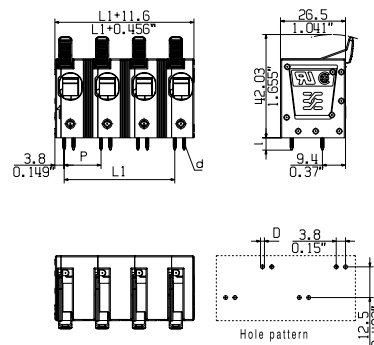

Accessories

Note: Refer to the Accessories chapter for additional accessories.

Screwdriver		Order No.
	SDIS 0.8X4.0X100	9008400000
	SDS 0.8X4.0X100	9008340000
Test plug		
	PS 2.0 MC	0310000000

Ordering data

Solder pin length		5 mm		
Colour		Black		
Pitch 15.00 mm				
Pol.	L1	(inch)	Qty.	Order No.
2	15.00	0.590	40	2492000000
3	30.00	1.181	40	2492010000
4	45.00	1.772	30	2492020000
5	60.00	2.362	25	2492030000
6	75.00	2.953	20	2492040000
7	90.00	3.543	10	2492050000
8	105.00	4.134	10	2492060000



Technical data

Machinery

Process

Energy

Transportation

Device Manufacturers

Infrastructure

**LUFS 15.00/./180V**

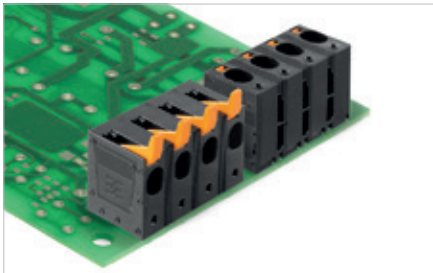

High-performance PCB terminal block with PUSH IN connection technology for conductor cross-sections up to 16 mm<sup>2</sup> in 15.00 mm pitch

- Fast connection thanks to pusher to open the contact point, or direct plug-in method
- Securely closed contact point; with the „Connection Safety Concept“ means the conductor is always clamped securely
- Integrated test point for PS 2.0 test plug
- Increased derating reserves because WEMID insulating material is used
- Wire outlet direction and activation in 180° version

**preliminary Technical data**

<b>In compliance with IEC 60664-1 / IEC 61984</b>			
Clamping range, max.	mm <sup>2</sup>	0.5...16	
<b>Solid core H05(07) V-U</b>	<b>mm<sup>2</sup></b>	<b>0.5...16</b>	
Stranded H07 V-R	mm <sup>2</sup>	6...16	
Flexible H05(07) V-K	mm <sup>2</sup>	0.5...16	
Flexible with ferrule	mm <sup>2</sup>	0.5...16	
Ferrule with plastic collar	mm <sup>2</sup>	0.5...16	
Stripping length	mm	18	
Screwdriver blade	mm	0.8 x 4.0	
According to norm			
Tightening torque range			
<b>Rated current, max.</b>	<b>A</b>	<b>76</b>	<b>76</b>
At ambient temperature		20°C	40°C
For conductor cross-section			
Overtoltage category		III	III II
Pollution severity		3	2 2
<b>Rated voltage</b>	<b>V</b>	<b>1000</b>	<b>1000 1000</b>
Rated impulse voltage	kV	8	8 8
<b>UL / CUL (Use Group)</b>	<b>B C D</b>		
<b>Rated voltage</b>	<b>V</b>	<b>600</b>	<b>600 600</b>
<b>Rated current</b>	<b>A</b>	<b>66</b>	<b>66 10</b>
<b>AWG conductor</b>	<b>AWG</b>		<b>20-4</b>
<b>CSA (Use Group)</b>	<b>B C D</b>		
Rated voltage	V	600	600 600
Rated current	A	66	66 10
AWG conductor	AWG		20-4
<b>General data</b>			
Type of insulation material		Wemid (PA)	
UL 94 flammability rating		V-0	
Contact base material		E-Cu	
Material of contact surface			
Pin dimensions = d	mm	1.2, Octagonal	
Solder eyelet Ø = D	mm	1.6	
Solder eyelet Ø tolerance	mm	+ 0,1	

**Product data**

IEC: 1000 V / 76 A / 0.5 - 16 mm<sup>2</sup>  
 UL: 600 V / 66 A / AWG 20 - 4



For additional articles and information, refer to [catalog.weidmuller.com](http://catalog.weidmuller.com)

**Note:**

- Additional colours on request
- Rated current related to rated cross-section & min. No. of poles.
- Wire end ferrule without plastic collar to DIN 46228/1
- Wire end ferrule with plastic collar to DIN 46228/4
- P on drawing = pitch
- Rated data refer only to the component itself. Clearance and creepage distances to other components are to be designed in accordance with the relevant application standards.
- The test point can only be used as potential-pickup point.

**LUFS 15.00/./180V**



**Dimensioned drawing**

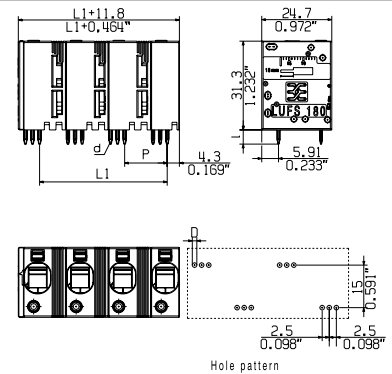

**Accessories**

**Note:** Refer to the Accessories chapter for additional accessories.

<b>Screwdriver</b>		<b>Order No.</b>
	SDIS 0.8X4.0X100	<b>9008400000</b>
	SDS 0.8X4.0X100	<b>9008340000</b>
<b>Test plug</b>		
	PS 2.0 MC	<b>0310000000</b>

**Ordering data**

<b>Solder pin length</b>		<b>5 mm</b>		
<b>Colour</b>		<b>Black</b>		
<b>Pitch</b>		<b>15.00 mm</b>		
Pol.	L1	(inch)	Qty.	Order No.
2	15.00	0.590	40	<b>2491820000</b>
3	30.00	1.181	40	<b>2492220000</b>
4	45.00	1.772	30	<b>2492230000</b>
5	60.00	2.362	25	<b>2492240000</b>
6	75.00	2.953	20	<b>2492250000</b>
7	90.00	3.543	10	<b>2492260000</b>
8	105.00	4.134	10	<b>2492270000</b>



Infrastructure



Device  
Manufacturers



Transportation



Energy



Process



Machinery

Technical data

Technical data

Machinery

Process

Energy

Transportation

Device Manufacturers

Infrastructure

LLF 7.50/./90

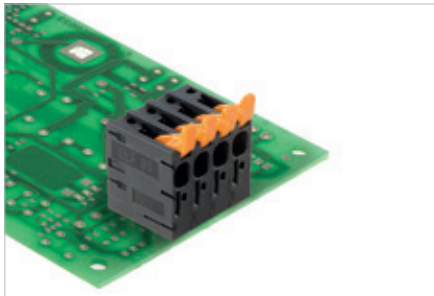

High-performance PCB terminal block with PUSH IN connection technology for wire cross-sections up to 6 mm<sup>2</sup>.

- Fast connection without tools thanks to an operating lever to open the contact point, or direct plug-in method
- Securely closed contact point; with the „Connection Safety Concept“ means the conductor is always clamped securely
- Integrated test point for PS 2.0 test plug
- Central tip test point for test probes on the upper side of the terminal
- Increased derating reserves because WEMID insulating material is used
- Wire outlet direction of 90°

preliminary Technical data

In compliance with IEC 60664-1 / IEC 61984			
Clamping range, max.	mm <sup>2</sup>	0.25...6	
<b>Solid core H05(07) V-U</b>	mm <sup>2</sup>	<b>0.5...6</b>	
Stranded H07 V-R			
Flexible H05(07) V-K	mm <sup>2</sup>	0.5...6	
Flexible with ferrule	mm <sup>2</sup>	0.25...6	
Ferrule with plastic collar	mm <sup>2</sup>	0.25...6	
Stripping length	mm	12	
Screwdriver blade	mm		
According to norm			
Tightening torque range			
<b>Rated current, max.</b>	<b>A</b>		
At ambient temperature		20°C	40°C
For conductor cross-section			
Overtoltage category		III	III II
Pollution severity		3	2 2
<b>Rated voltage</b>	<b>V</b>	<b>600</b>	<b>600 1000</b>
Rated impulse voltage	kV	6	6 6
<b>UL / CUL (Use Group)</b>		<b>B</b>	<b>C D</b>
<b>Rated voltage</b>	<b>V</b>	<b>600</b>	<b>600</b>
<b>Rated current</b>	<b>A</b>	<b>35</b>	<b>35</b>
<b>AWG conductor</b>	<b>AWG</b>	<b>24-10</b>	
<b>CSA (Use Group)</b>		<b>B</b>	<b>C D</b>
Rated voltage	V	600	600
Rated current	A	35	35
AWG conductor	AWG	24-10	
General data			
Type of insulation material		Wemid (PA)	
UL 94 flammability rating		V-0	
Contact base material		E-Cu	
Material of contact surface			
Pin dimensions = d	mm	1.2	
Solder eyelet Ø = D	mm	2	
Solder eyelet Ø tolerance	mm	+ 0,1	

Product data

IEC: 1000 V / 0.5 - 6 mm<sup>2</sup>  
 UL: 600 V / 35 A / AWG 24 - 10



For additional articles and information, refer to [catalog.weidmuller.com](http://catalog.weidmuller.com)

Note:

- Additional colours on request
- Rated current related to rated cross-section & min. No. of poles.
- Wire end ferrule without plastic collar to DIN 46228/1
- Wire end ferrule with plastic collar to DIN 46228/4
- P on drawing = pitch
- Rated data refer only to the component itself. Clearance and creepage distances to other components are to be designed in accordance with the relevant application standards.
- The test point can only be used as potential-pickup point.

LLF 7.50/./90



Dimensioned drawing

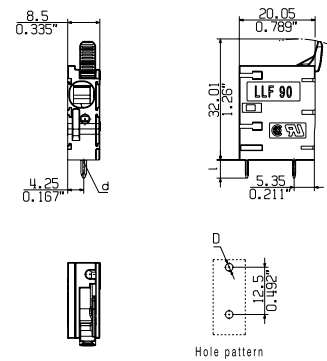

Accessories

Note: Refer to the Accessories chapter for additional accessories.

Screwdriver		Order No.
	SDIS 0.5X3.0X100	<b>9008380000</b>
	SDS 0.5X3.0X80	<b>9008320000</b>
Test plug		
	PS 2.0 MC	<b>0310000000</b>

Ordering data

Solder pin length		5 mm	
Colour		Black	
Pitch		7.50 mm <sup>2</sup>	
Pol.	L1	(inch)	Qty. Order No.
1	0.00	0.000	400 <b>2471520000</b>

LLF 7.50/./90V

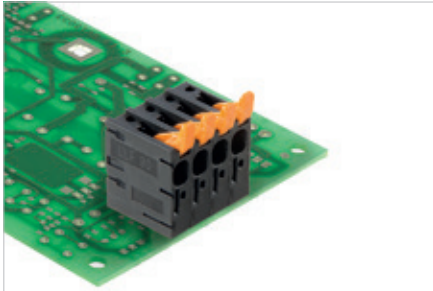

High-performance PCB terminal with PUSH IN connection technology for conductor cross-sections up to 6 mm<sup>2</sup>.

- Fast connection without tools thanks to an operating lever to open the contact point, or direct plug-in method
- Securely closed contact point; with the „Connection Safety Concept“ means the conductor is always clamped securely
- Integrated test point for PS 2.0 test plug
- Central tip test point for test probes on the upper side of the terminal
- Increased derating reserves because WEMID insulating material is used
- Conductor outlet direction in 90° version

preliminary Technical data

<b>In compliance with IEC 60664-1 / IEC 61984</b>			
Clamping range, max.	mm <sup>2</sup>	0.25...6	
<b>Solid core H05(07) V-U</b>	<b>mm<sup>2</sup></b>	<b>0.5...6</b>	
Stranded H07 V-R			
Flexible H05(07) V-K	mm <sup>2</sup>	0.5...6	
Flexible with ferrule	mm <sup>2</sup>	0.25...6	
Ferrule with plastic collar	mm <sup>2</sup>	0.25...6	
Stripping length	mm	12	
Screwdriver blade	mm		
According to norm			
Tightening torque range			
<b>Rated current, max.</b>	<b>A</b>		
At ambient temperature		20°C	40°C
For conductor cross-section			
Overtoltage category		III	III II
Pollution severity		3	2 2
<b>Rated voltage</b>	<b>V</b>	<b>1000</b>	<b>1000 1000</b>
Rated impulse voltage	kV	8	8 8
<b>UL / CUL (Use Group)</b>		<b>B</b>	<b>C D</b>
<b>Rated voltage</b>	<b>V</b>	<b>600</b>	<b>600</b>
<b>Rated current</b>	<b>A</b>	<b>35</b>	<b>35</b>
<b>AWG conductor</b>	<b>AWG</b>	<b>24-10</b>	
<b>CSA (Use Group)</b>		<b>B</b>	<b>C D</b>
Rated voltage	V	600	600
Rated current	A	35	35
AWG conductor	AWG	24-10	
<b>General data</b>			
Type of insulation material		Wemid (PA)	
UL 94 flammability rating		V-0	
Contact base material		E-Cu	
Material of contact surface			
Pin dimensions = d	mm	1.2	
Solder eyelet Ø = D	mm	2	
Solder eyelet Ø tolerance	mm	+ 0,1	

Product data

IEC: 1000 V / 0.5 - 6 mm<sup>2</sup>  
 UL: 600 V / 35 A / AWG 24 - 10



For additional articles and information, refer to [catalog.weidmueller.com](http://catalog.weidmueller.com)

Note:

- Additional colours on request
- Rated current related to rated cross-section & min. No. of poles.
- Wire end ferrule without plastic collar to DIN 46228/1
- Wire end ferrule with plastic collar to DIN 46228/4
- P on drawing = pitch
- Rated data refer only to the component itself. Clearance and creepage distances to other components are to be designed in accordance with the relevant application standards.
- The test point can only be used as potential-pickup point.

LLF 7.50/./90V



Dimensioned drawing

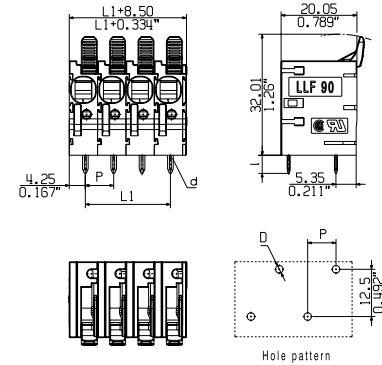

Accessories

Note: Refer to the Accessories chapter for additional accessories.

Screwdriver		Order No.
	SDIS 0.5X3.0X100	<b>9008380000</b>
	SDS 0.5X3.0X80	<b>9008320000</b>
Test plug		
	PS 2.0 MC	<b>0310000000</b>

Ordering data

Solder pin length		5 mm		
Colour		Black		
Pitch 7.50 mm <sup>2</sup>				
Pol.	L1	(inch)	Qty.	Order No.
2	7.50	0.295	200	<b>2471530000</b>
3	15.00	0.590	200	<b>2472090000</b>
4	22.50	0.885	150	<b>2472100000</b>
5	30.00	1.180	100	<b>2472110000</b>
6	37.50	1.475	50	<b>2472120000</b>
7	45.00	1.770	50	<b>2472130000</b>
8	52.50	2.065	50	<b>2472140000</b>
9	60.00	2.360	50	<b>2472150000</b>
10	67.50	2.655	30	<b>2472160000</b>
11	75.00	2.950	30	<b>2472170000</b>
12	82.50	3.245	30	<b>2472180000</b>



### Stripping and crimping machines

- Purely electrically driven for processing harmonised PVC conductors
- Crimping range from 0.5 - 2.5 mm<sup>2</sup> (AWG 20 - 14)
- Weidmüller wire-end ferrules interlinked on reel
- Adjustable stripping blade
- Integrated daily, total and service counter
- No tool replacement with change of cross-section range
- Simple changing of machine parameters for the entire crimping range

### Crimpfix E



### Technical data

Specification	
Stripping range	
Crimping length	
Length of wire-end ferrule	
Pulse time	
Cross-section range	
Electrical connection	
Tool data	
Length / Width / Height	mm
Weight	kg
Note	

CRIMPFIX E	
Stripping range	0.5 - 2.5 mm <sup>2</sup>
Crimping length	8 mm
Length of wire-end ferrule	14 mm
Pulse time	approx. 1.8 sec
Cross-section range	0.5...2.5 mm <sup>2</sup>
Electrical connection	100 - 240 V AC / 50 - 60 Hz
Length / Width / Height	349 / 288 / 230 mm
Weight	16 kg
Note	

### Ordering data

Version
Note

Type	Qty.	Order No.
CRIMPFIX E	1	2439140000
Note		





Infrastructure



Device  
Manufacturers



Transportation



Energy



Process



Machinery

Technical data

### EPG 60 battery-powered hydraulic crimping tool

- Electrohydraulic battery-powered crimping tool
- Processing of cable lugs and connectors up to 300 mm<sup>2</sup>
- Quick-closure head rotatable up to 270°
- Automatic pressure limiting and monitoring with pressure sensor
- Motor switch-off and automatic return after completed crimping process
- Electronic control and monitoring of the crimping process
- Integrated service management and software updates via USB
- Multi-function electronics with sleep mode, maintenance display and battery monitoring
- Li-Ion battery with charge state display

### EPG 60



#### Technical data

Description of contact	
Pressing force	kN
Tool data	
Length x width x height / Weight	mm/GRM
Note	

EPG 60	
60	
385 / 125 / 80 / 3280	
Weight incl. battery	

Areas of application	Ø mm <sup>2</sup>
WM crimping inserts for EURO series	6 - 300
Hexagonal crimping inserts (DIN 46235) + connectors (DIN 46267)	6 - 300 (K5-K30)
Indent crimping inserts DIN 46234	6 - 120

#### Ordering data

Version	
Note	

Type	Qty.	Order No.
EPG 60	1	2453810000
Note		

#### Accessories

Replacement battery Li-Ion 18 V, 1.5 Ah	
Charger	
Note	

Type	Qty.	Order No.
AKKU EPG	1	1500840000
LADEGERAET EPG	1	1509370000
Note		

**WM-shape crimp inserts**

- For crimping cable lugs and connectors of the Euro series

Cu mm <sup>2</sup>	Crimping width	Type	Order No.
6	7 mm	ES EPG 60 WM 6	2469380000
10	7 mm	ES EPG 60 WM 10	2469540000
16	7 mm	ES EPG 60 WM 16	2469550000
25	12 mm	ES EPG 60 WM 25	2469560000
35	5 mm	ES EPG 60 WM 35	2469570000
50	5 mm	ES EPG 60 WM 50	2469580000
70	5 mm	ES EPG 60 WM 70	2469590000
95	5 mm	ES EPG 60 WM 95	2469600000
120	5 mm	ES EPG 60 WM 120	2469610000
150	5 mm	ES EPG 60 WM 150	2469620000
185	5 mm	ES EPG 60 WM 185	2469630000
240	5 mm	ES EPG 60 WM 240	2469640000
300	5 mm	ES EPG 60 WM 300	2469650000
<b>Note</b>			

**Hexagonal crimp inserts**

- For crimping compression cable lugs DIN 46235
- CU crimp connectors DIN 46267 Part 1
- Al and Al/Cu compression cable lugs and connectors

Ident. no.	Cu mm <sup>2</sup>	Al mm <sup>2</sup>	Crimping width	Type	Order No.
5	6		7 mm	ES EPG 60 HEX 6	2505150000
6	10		7 mm	ES EPG 60 HEX 10	2505160000
8	16		5 mm	ES EPG 60 HEX 16	2505170000
10	25	10	5 mm	ES EPG 60 HEX 25	2505180000
12	35	16+25	5 mm	ES EPG 60 HEX 35	2505190000
14	50	35	5 mm	ES EPG 60 HEX 50	2505200000
16	70	50	5 mm	ES EPG 60 HEX 70	2505210000
18	95	70	5 mm	ES EPG 60 HEX 95	2505220000
20	120		5 mm	ES EPG 60 HEX 120	2505230000
22	150	95+120	5 mm	ES EPG 60 HEX 150	2505240000
25	185	150	5 mm	ES EPG 60 HEX 185	2505250000
28	240	185	5 mm	ES EPG 60 HEX 240	2505260000
32	300	240	5 mm	ES EPG 60 HEX 300	2505270000
<b>Note</b>					

**Indent crimp inserts**

- For crimping cable lugs DIN 46234
- Pin cable lugs DIN 46230
- Connector DIN 46341 Part 1

Cu mm <sup>2</sup>	Crimping width	Type	Order No.
6	5 mm	ES EPG 60 DIN 6	2505280000
10	7 mm	ES EPG 60 DIN 10	2505290000
16	10 mm	ES EPG 60 DIN 16	2505300000
25	10 mm	ES EPG 60 DIN 25	2505310000
35	10 mm	ES EPG 60 DIN 35	2505320000
50	12 mm	ES EPG 60 DIN 50	2505330000
70	12 mm	ES EPG 60 DIN 70	2505340000
95	16 mm	ES EPG 60 DIN 95	2505350000
120	16 mm	ES EPG 60 DIN 120	2505360000
<b>Note</b>			



## EPG Cut 40 battery-powered hydraulic crimping tool

- Electrohydraulic battery-powered cutting tool
- Cutting of CU/AL conductors up to Ø 40 mm
- Quick closure head rotatable up to 360°
- Automatic pressure limiting and monitoring with pressure sensor
- Motor switch-off and automatic return after completed cutting process
- Electronic control and monitoring of the cutting process
- Integrated service management and software updates via USB
- Multi-function electronics with sleep mode, maintenance display and battery monitoring
- Li-Ion battery with charge state display

### EPG CUT 40



#### Technical data

<b>Description of contact</b>	
Punching force	
<b>Tool data</b>	
Length x width x height / Weight	mm/GRM
<b>Note</b>	

<b>EPG CUT 40</b>		
30 kN		
440 / 124 / 81 / 2800		
Weight incl. battery		

#### Ordering data

<b>Version</b>	
<b>Note</b>	

Type	Qty.	Order No.
EPG CUT 40	1	2453830000

#### Accessories

Replacement battery Li-Ion 18 V, 1.5 Ah	
Charger	
<b>Note</b>	

Type	Qty.	Order No.
AKKU EPG	1	1500840000
LADEGERAET EPG	1	1509370000

Cutting ranges	Ø mm <sup>2</sup>
CU to max.	Ø 40 mm
AL to max.	Ø 40 mm
<b>Multi-wire cutting range</b>	
CU to max.	1x 240 mm or 4 x 50 mm
AL to max.	1x 500 mm or 4x 70 mm



Infrastructure



Device  
Manufacturers



Transportation



Energy



Process



Machinery

Technical data

2-pole voltage testers

VT CTB

2-pole voltage tester for cars



- Test probe
- Pin with sliding mechanism
- Cable length 130 cm
- Polarity detection

VT

2-pole voltage tester



- LED display for voltage and polarity
- Works without batteries
- Impact-resistant housing
- One-handed operation for sockets

Technical data

Nominal voltage
Display
Frequency range, min.
Measuring range category
Protection degree
Approvals
Weight
Note

<b>VT CTB</b>
3 V DC...48 V DC
LED
0...65 Hz
IP40
EN 61010-1, EN 61326
50 g
Note

<b>VT</b>
12 V AC/DC...690 V AC/DC
LED
0...65 Hz
CAT III 600 V, CAT IV 300 V
IP64
EN/ IEC 61010, EN 61243-3 2010
115 g
Note

Ordering data

Version
Note

Type	Qty.	Order No.
VT CTB	1	9918970000
Note		

Type	Qty.	Order No.
VT	1	9918950000
Note		

Accessories

Note
------

Type	Qty.	Order No.
SKAI TASCHÉ	1	9201520000
BATTERIE 1,5V MICRO	2	9201310000
Note		

Type	Qty.	Order No.
SKAI TASCHÉ	1	9201520000
BATTERIE 1,5V MICRO	2	9201310000
Note		

Technical data

Machinery

Process

Energy

Transportation

Device  
Manufacturers

Infrastructure

Non-contact voltage testers

VT CL

Non-contact voltage tester



- Overvoltage category CAT IV 1000V
- Visible and acoustic voltage display
- Water-resistant and robust housing

VT LCL

Non-contact voltage tester



- Overvoltage category CAT IV 1000V
- Visible and acoustic voltage display
- Integrated flashlight
- Two selectable voltage levels / sensitivity ranges
- Including battery monitoring

Technical data

Nominal voltage
Display
Protection degree
Measuring range category
Battery type
Approvals
Weight
<b>Note</b>

<b>VT CL</b>
50 V AC...1000 V AC
Visual & acoustic
IP65
CAT IV 1000 V
1.5 V type AAA battery
DIN EN 61010-1, DIN EN 61326
60 g

<b>VT LCL</b>
12 V AC...1000 V AC
Visual & acoustic
IP65
CAT IV 1000 V
1.5 V type AAA battery
DIN EN 61010-1, DIN EN 61326
60 g

Ordering data

<b>Version</b>
<b>Note</b>

Type	Qty.	Order No.
VT CL	1	2436660000

Type	Qty.	Order No.
VT LCL	1	2436670000

Accessories

<b>Note</b>
-------------

Type	Qty.	Order No.
BATTERIE 1,5V MICRO	2	9201310000

Type	Qty.	Order No.
BATTERIE 1,5V MICRO	2	9201310000

Technical data

Machinery

Process

Energy

Transportation

Device Manufacturers

Infrastructure

Continuity testers and non-contact magnetic field testers

VT M

Non-contact magnetic field tester



- Integrated flashlight
- Magnetic field displayed with a red LED
- Water-resistant and robust housing
- Including battery monitoring

VT CTL

Continuity tester



- Flashlight function with continuous light
- Visual and acoustic feed-through
- Resistant to interference voltage

Technical data

Display
Protection degree
Battery type
Approvals
Weight
Note

<b>VT M</b>
Visual & acoustic
IP65
1.5 V type AAA battery
DIN EN 61010-1, DIN EN 61326
60 g
Note

<b>VT CTL</b>
Visual & acoustic
IP44
1.5 V type AAA battery
DIN EN 61010-1
140 g
Note

Ordering data

Version
Note

Type	Qty.	Order No.
VT M	1	2436680000
Note		

Type	Qty.	Order No.
VT CTL	1	2436690000
Note		

Accessories

Note
------

Type	Qty.	Order No.
BATTERIE 1,5V MICRO	2	9201310000
Note		

Type	Qty.	Order No.
BATTERIE 1,5V MICRO	2	9201310000
Note		

Technical data

Machinery

Process

Energy

Transportation

Device  
Manufacturers

Infrastructure





Infrastructure



Device  
Manufacturers



Transportation



Energy



Process



Machinery

Technical data

HS... 25,4 mm

Technical data

Material	Rate of shrinkage	Temperature range	recom. Shrinks.	Order No.	Type
Polyolefine	3:1	-55...135 °C	90 °C	<b>2448880000</b>	RIBBON MM-HS 60/300 SW

Ordering data

Order No.	Type	Colour	Length	Conductor O.D.	Qty.
2437470000	HS 0.8-2.4/25 MM W	○ White	25.4 mm	0.8 - 2.4 mm	2000
2437480000	HS 0.8-2.4/25 MM Y	● Yellow	25.4 mm	0.8 - 2.4 mm	2000
2437510000	HS 1.0-3.2/25 MM W	○ White	25.4 mm	1 - 3.2 mm	2000
2437520000	HS 1.0-3.2/25 MM Y	● Yellow	25.4 mm	1 - 3.2 mm	2000
2437550000	HS 1.6-4.8/25 MM W	○ White	25.4 mm	1.6 - 4.8 mm	2000
2437560000	HS 1.6-4.8/25 MM Y	● Yellow	25.4 mm	1.6 - 4.8 mm	2000
2437630000	HS 2.1-6.4/25 MM W	○ White	25.4 mm	2.1 - 6.4 mm	2000
2437640000	HS 2.1-6.4/25 MM Y	● Yellow	25.4 mm	2.1 - 6.4 mm	2000
2437670000	HS 3.2-9.5/25 MM W	○ White	25.4 mm	3.2 - 9.5 mm	1000
2437680000	HS 3.2-9.5/25 MM Y	● Yellow	25.4 mm	3.2 - 9.5 mm	1000
2437710000	HS 4.2-12.7/25 MM W	○ White	25.4 mm	4.2 - 12.7 mm	1000
2437720000	HS 4.2-12.7/25 MM Y	● Yellow	25.4 mm	4.2 - 12.7 mm	1000
2437750000	HS 6.4-19.1/25 MM W	○ White	25.4 mm	6.4 - 19.1 mm	800
2437760000	HS 6.4-19.1/25 MM Y	● Yellow	25.4 mm	6.4 - 19.1 mm	800
2437790000	HS 8.5-25.4/25 MM W	○ White	25.4 mm	8.5 - 25.4 mm	400
2437800000	HS 8.5-25.4/25 MM Y	● Yellow	25.4 mm	8.5 - 25.4 mm	400
2437590000	HS 12.7-38.1/25 MM W	○ White	25.4 mm	12.7 - 38.1 mm	200
2437600000	HS 12.7-38.1/25 MM Y	● Yellow	25.4 mm	12.7 - 38.1 mm	200



HS... 50,8 mm

Technical data

Material	Rate of shrinkage	Temperature range	recom. Shrinks.	Order No.	Type
Polyolefine	3:1	-55...135 °C	90 °C	<b>2448880000</b>	RIBBON MM-HS 60/300 SW

Ordering data

Order No.	Type	Colour	Length	Conductor O.D.	Qty.
2437490000	HS 0.8-2.4/50 MM W	○ White	50.8 mm	0.8 - 2.4 mm	1000
2437500000	HS 0.8-2.4/50 MM Y	● Yellow	50.8 mm	0.8 - 2.4 mm	1000
2437530000	HS 1.0-3.2/50 MM W	○ White	50.8 mm	1 - 3.2 mm	1000
2437540000	HS 1.0-3.2/50 MM Y	● Yellow	50.8 mm	1 - 3.2 mm	1000
2437570000	HS 1.6-4.8/50 MM W	○ White	50.8 mm	1.6 - 4.8 mm	1000
2437580000	HS 1.6-4.8/50 MM Y	● Yellow	50.8 mm	1.6 - 4.8 mm	1000
2437650000	HS 2.1-6.4/50 MM W	○ White	50.8 mm	2.1 - 6.4 mm	1000
2437660000	HS 2.1-6.4/50 MM Y	● Yellow	50.8 mm	2.1 - 6.4 mm	1000
2437690000	HS 3.2-9.5/50 MM W	○ White	50.8 mm	3.2 - 9.5 mm	500
2437700000	HS 3.2-9.5/50 MM Y	● Yellow	50.8 mm	3.2 - 9.5 mm	500
2437730000	HS 4.2-12.7/50 MM W	○ White	50.8 mm	4.2 - 12.7 mm	500
2437740000	HS 4.2-12.7/50 MM Y	● Yellow	50.8 mm	4.2 - 12.7 mm	500
2437770000	HS 6.4-19.1/50 MM W	○ White	50.8 mm	6.4 - 19.1 mm	400
2437780000	HS 6.4-19.1/50 MM Y	● Yellow	50.8 mm	6.4 - 19.1 mm	400
2437810000	HS 8.5-25.4/50 MM W	○ White	50.8 mm	8.5 - 25.4 mm	200
2437820000	HS 8.5-25.4/50 MM Y	● Yellow	50.8 mm	8.5 - 25.4 mm	200
2437610000	HS 12.7-38.1/50 MM W	○ White	50.8 mm	12.7 - 38.1 mm	100
2437620000	HS 12.7-38.1/50 MM Y	● Yellow	50.8 mm	12.7 - 38.1 mm	100



Technical data

Machinery

Process

Energy

Transportation

Device Manufacturers

Infrastructure

## HS-HF 25.4 mm

### Technical data

Material	Rate of shrinkage	Temperature range	recom. Shrinks.	Order No.	Type
Polyolefine	2:1	-55...105 °C	90 °C	<b>2448880000</b>	RIBBON MM-HS 60/300 SW

### Ordering data

Order No.	Type	Colour	Length	Conductor O.D.	Qty.
2437830000	HS-HF 1.2-2.4/25 MM W	○ White	25.4 mm	1.2 - 2.4 mm	2000
2437840000	HS-HF 1.2-2.4/25 MM Y	● Yellow	25.4 mm	1.2 - 2.4 mm	2000
2437870000	HS-HF 1.6-3.2/25 MM W	○ White	25.4 mm	1.6 - 3.2 mm	2000
2437880000	HS-HF 1.6-3.2/25 MM Y	● Yellow	25.4 mm	1.6 - 3.2 mm	2000
2437990000	HS-HF 2.4-4.8/25 MM W	○ White	25.4 mm	2.4 - 4.8 mm	2000
2438000000	HS-HF 2.4-4.8/25 MM Y	● Yellow	25.4 mm	2.4 - 4.8 mm	2000
2438040000	HS-HF 3.2-6.4/25 MM W	○ White	25.4 mm	3.2 - 6.4 mm	2000
2438050000	HS-HF 3.2-6.4/25 MM Y	● Yellow	25.4 mm	3.2 - 6.4 mm	2000
2438090000	HS-HF 4.8-9.5/25 MM W	○ White	25.4 mm	4.8 - 9.5 mm	1000
2438100000	HS-HF 4.8-9.5/25 MM Y	● Yellow	25.4 mm	4.8 - 9.5 mm	1000
2438140000	HS-HF 6.4-12.7/25 MM W	○ White	25.4 mm	6.4 - 12.7 mm	1000
2438150000	HS-HF 6.4-12.7/25 MM Y	● Yellow	25.4 mm	6.4 - 12.7 mm	1000
2438190000	HS-HF 9.5-19.1/25 MM W	○ White	25.4 mm	9.5 - 19.1 mm	800
2438200000	HS-HF 9.5-19.1/25 MM Y	● Yellow	25.4 mm	9.5 - 19.1 mm	800
2437910000	HS-HF 12.7-25.4/25 MM W	○ White	25.4 mm	12.7 - 25.4 mm	400
2437920000	HS-HF 12.7-25.4/25 MM Y	● Yellow	25.4 mm	12.7 - 25.4 mm	400
2437950000	HS-HF 19.5-38.1/25 MM W	○ White	25.4 mm	19.5 - 38.1 mm	200
2437960000	HS-HF 19.5-38.1/25 MM Y	● Yellow	25.4 mm	19.5 - 38.1 mm	200

## HS-HF 50.8 mm

### Technical data

Material	Rate of shrinkage	Temperature range	recom. Shrinks.	Order No.	Type
Polyolefine	2:1	-55...105 °C	90 °C	<b>2448880000</b>	RIBBON MM-HS 60/300 SW

### Ordering data

Order No.	Type	Colour	Length	Conductor O.D.	Qty.
2437850000	HS-HF 1.2-2.4/50 MM W	○ White	50.8 mm	1.2 - 2.4 mm	1000
2437860000	HS-HF 1.2-2.4/50 MM Y	● Yellow	50.8 mm	1.2 - 2.4 mm	1000
2437890000	HS-HF 1.6-3.2/50 MM W	○ White	50.8 mm	1.6 - 3.2 mm	1000
2437900000	HS-HF 1.6-3.2/50 MM Y	● Yellow	50.8 mm	1.6 - 3.2 mm	1000
2438010000	HS-HF 2.4-4.8/50 MM W	○ White	50.8 mm	2.4 - 4.8 mm	1000
2438020000	HS-HF 2.4-4.8/50 MM Y	● Yellow	50.8 mm	2.4 - 4.8 mm	1000
2438060000	HS-HF 3.2-6.4/50 MM W	○ White	50.8 mm	3.2 - 6.4 mm	1000
2438070000	HS-HF 3.2-6.4/50 MM Y	● Yellow	50.8 mm	3.2 - 6.4 mm	1000
2438110000	HS-HF 4.8-9.5/50 MM W	○ White	50.8 mm	4.8 - 9.5 mm	500
2438120000	HS-HF 4.8-9.5/50 MM Y	● Yellow	50.8 mm	4.8 - 9.5 mm	500
2438160000	HS-HF 6.4-12.7/50 MM W	○ White	50.8 mm	6.4 - 12.7 mm	500
2438170000	HS-HF 6.4-12.7/50 MM Y	● Yellow	50.8 mm	6.4 - 12.7 mm	500
2438210000	HS-HF 9.5-19.1/50 MM W	○ White	50.8 mm	9.5 - 19.1 mm	400
2438220000	HS-HF 9.5-19.1/50 MM Y	● Yellow	50.8 mm	9.5 - 19.1 mm	400
2437930000	HS-HF 12.7-25.4/50 MM W	○ White	50.8 mm	12.7 - 25.4 mm	200
2437940000	HS-HF 12.7-25.4/50 MM Y	● Yellow	50.8 mm	12.7 - 25.4 mm	200
2437970000	HS-HF 19.5-38.1/50 MM W	○ White	50.8 mm	19.5 - 38.1 mm	100
2437980000	HS-HF 19.5-38.1/50 MM Y	● Yellow	50.8 mm	19.5 - 38.1 mm	100



Technical data

Machinery



Process



Energy



Transportation



Device Manufacturers



Infrastructure



HSS... Endless 13 meters

Technical data

Material	Rate of shrinkage	Temperature range	recom. Shrinks.	Order No.	Type
Polyolefine	3:1	-55...135 °C	90 °C	1426210000	RIBBON HSS HF EL 40/300

Ordering data

Order No.	Type	Colour	Length	Conductor O.D.	Qty.
1489620000	HSS 0.8-2.4 EL W13M	○ White	13000 mm	0.8 - 2.4 mm	1
1489530000	HSS 0.8-2.4 EL Y13M	● Yellow	13000 mm	0.8 - 2.4 mm	1
1489630000	HSS 1.0-3.2 EL W13M	○ White	13000 mm	1 - 3.2 mm	1
1489540000	HSS 1.0-3.2 EL Y13M	● Yellow	13000 mm	1 - 3.2 mm	1
1489640000	HSS 1.6-4.8 EL W13M	○ White	13000 mm	1.6 - 4.8 mm	1
1489550000	HSS 1.6-4.8 EL Y13M	● Yellow	13000 mm	1.6 - 4.8 mm	1
1489650000	HSS 2.1-6.4 EL W13M	○ White	13000 mm	2.1 - 6.4 mm	1
1489560000	HSS 2.1-6.4 EL Y13M	● Yellow	13000 mm	2.1 - 6.4 mm	1
1489660000	HSS 3.2-9.5 EL W13M	○ White	13000 mm	3.2 - 9.5 mm	1
1489570000	HSS 3.2-9.5 EL Y13M	● Yellow	13000 mm	3.2 - 9.5 mm	1
1489670000	HSS 4.2-12.7 EL W13M	○ White	13000 mm	4.2 - 12.7 mm	1
1489580000	HSS 4.2-12.7 EL Y13M	● Yellow	13000 mm	4.2 - 12.7 mm	1
1489680000	HSS 6.4-19.1 EL W13M	○ White	13000 mm	6.4 - 19.1 mm	1
1489590000	HSS 6.4-19.1 EL Y13M	● Yellow	13000 mm	6.4 - 19.1 mm	1



HSS... Endless 30 meters

Technical data

Material	Rate of shrinkage	Temperature range	recom. Shrinks.	Order No.	Type
Polyolefine	3:1	-55...135 °C	90 °C	1426210000	RIBBON HSS HF EL 40/300

Ordering data

Order No.	Type	Colour	Length	Conductor O.D.	Qty.
1505840000	HSS 0.8-2.4 EL W30M	○ White	30000 mm	0.8 - 2.4 mm	1
1505760000	HSS 0.8-2.4 EL Y30M	● Yellow	30000 mm	0.8 - 2.4 mm	1
1505850000	HSS 1.0-3.2 EL W30M	○ White	30000 mm	1 - 3.2 mm	1
1505770000	HSS 1.0-3.2 EL Y30M	● Yellow	30000 mm	1 - 3.2 mm	1
1505860000	HSS 1.6-4.8 EL W30M	○ White	30000 mm	1.6 - 4.8 mm	1
1505780000	HSS 1.6-4.8 EL Y30M	● Yellow	30000 mm	1.6 - 4.8 mm	1
1505870000	HSS 2.1-6.4 EL W30M	○ White	30000 mm	2.1 - 6.4 mm	1
1505790000	HSS 2.1-6.4 EL Y30M	● Yellow	30000 mm	2.1 - 6.4 mm	1
1505880000	HSS 3.2-9.5 EL W30M	○ White	30000 mm	3.2 - 9.5 mm	1
1505800000	HSS 3.2-9.5 EL Y30M	● Yellow	30000 mm	3.2 - 9.5 mm	1
1505890000	HSS 4.2-12.7 EL W30M	○ White	30000 mm	4.2 - 12.7 mm	1
1505810000	HSS 4.2-12.7 EL Y30M	● Yellow	30000 mm	4.2 - 12.7 mm	1
1505900000	HSS 6.4-19.1 EL W30M	○ White	30000 mm	6.4 - 19.1 mm	1
1505820000	HSS 6.4-19.1 EL Y30M	● Yellow	30000 mm	6.4 - 19.1 mm	1
1505910000	HSS 8.5-25.4 EL W30M	○ White	30000 mm	8.5 - 25.4 mm	1
1505830000	HSS 8.5-25.4 EL Y30M	● Yellow	30000 mm	8.5 - 25.4 mm	1



Technical data

Machinery

Process

Energy

Transportation

Device Manufacturers

Infrastructure

**HSS-HF... Halogen-free Endless 13 meters**
**Technical data**

Material	Rate of shrinkage	Temperature range	recom. Shrinks.	Order No.	Type
Polyolefine	2:1	-55...105 °C	90 °C	<b>1426210000</b>	RIBBON HSS HF EL 40/300

**Ordering data**

Order No.	Type	Colour	Length	Conductor O.D.	Qty.
1423330000	HSS-HF 1.2-2.4 EL W13M	White	13000 mm	1.2 - 2.4 mm	1
1423220000	HSS-HF 1.2-2.4 EL Y13M	Yellow	13000 mm	1.2 - 2.4 mm	1
1423340000	HSS-HF 1.6-3.2 EL W13M	White	13000 mm	1.6 - 3.2 mm	1
1423230000	HSS-HF 1.6-3.2 EL Y13M	Yellow	13000 mm	1.6 - 3.2 mm	1
1423350000	HSS-HF 2.4-4.8 EL W13M	White	13000 mm	2.4 - 4.8 mm	1
1423240000	HSS-HF 2.4-4.8 EL Y13M	Yellow	13000 mm	2.4 - 4.8 mm	1
1423360000	HSS-HF 3.2-6.4 EL W13M	White	13000 mm	3.2 - 6.4 mm	1
1423250000	HSS-HF 3.2-6.4 EL Y13M	Yellow	13000 mm	3.2 - 6.4 mm	1
1423370000	HSS-HF 4.8-9.5 EL W13M	White	13000 mm	4.8 - 9.5 mm	1
1423260000	HSS-HF 4.8-9.5 EL Y13M	Yellow	13000 mm	4.8 - 9.5 mm	1
1423380000	HSS-HF 6.4-12.7 EL W13M	White	13000 mm	6.4 - 12.7 mm	1
1423270000	HSS-HF 6.4-12.7 EL Y13M	Yellow	13000 mm	6.4 - 12.7 mm	1

**HSS-HF... Halogen-free Endless 10 meters**
**Technical data**

Material	Rate of shrinkage	Temperature range	recom. Shrinks.	Order No.	Type
Polyolefine	2:1	-55...105 °C	90 °C	<b>1426210000</b>	RIBBON HSS HF EL 40/300

**Ordering data**

Order No.	Type	Colour	Length	Conductor O.D.	Qty.
1423390000	HSS-HF 9.5-19.1 EL W10M	White	10000 mm	9.5 - 19.1 mm	1
1423280000	HSS-HF 9.5-19.1 EL Y10M	Yellow	10000 mm	9.5 - 19.1 mm	1
1423410000	HSS-HF 12.7-25.4 EL W10M	White	10000 mm	12.7 - 25.4 mm	1
1423290000	HSS-HF 12.7-25.4 EL Y10M	Yellow	10000 mm	12.7 - 25.4 mm	1



Technical data

Machinery



Process



Energy



Transportation

 Device  
Manufacturers

Infrastructure



HSS-HF... Halogen-free Endless 30 meters



Technical data

Material	Rate of shrinkage	Temperature range	recom. Shrinks.	Order No.	Type
Polyolefine	2:1	-55...105 °C	90 °C	<b>1426210000</b>	RIBBON HSS HF EL 40/300

Ordering data

Order No.	Type	Colour	Length	Conductor O.D.	Qty.
1562840000	HSS-HF 1.2-2.4 EL B30M	Blue	30000 mm	1.2 - 2.4 mm	1
1562940000	HSS-HF 1.2-2.4 EL G30M	Green	30000 mm	1.2 - 2.4 mm	1
1562740000	HSS-HF 1.2-2.4 EL R30M	Red	30000 mm	1.2 - 2.4 mm	1
1513240000	HSS-HF 1.2-2.4 EL W30M	White	30000 mm	1.2 - 2.4 mm	1
1513140000	HSS-HF 1.2-2.4 EL Y30M	Yellow	30000 mm	1.2 - 2.4 mm	1
1562850000	HSS-HF 1.6-3.2 EL B30M	Blue	30000 mm	1.6 - 3.2 mm	1
1562950000	HSS-HF 1.6-3.2 EL G30M	Green	30000 mm	1.6 - 3.2 mm	1
1562750000	HSS-HF 1.6-3.2 EL R30M	Red	30000 mm	1.6 - 3.2 mm	1
1513250000	HSS-HF 1.6-3.2 EL W30M	White	30000 mm	1.6 - 3.2 mm	1
1513150000	HSS-HF 1.6-3.2 EL Y30M	Yellow	30000 mm	1.6 - 3.2 mm	1
1562870000	HSS-HF 2.4-4.8 EL B30M	Blue	30000 mm	2.4 - 4.8 mm	1
1562970000	HSS-HF 2.4-4.8 EL G30M	Green	30000 mm	2.4 - 4.8 mm	1
1562770000	HSS-HF 2.4-4.8 EL R30M	Red	30000 mm	2.4 - 4.8 mm	1
1513270000	HSS-HF 2.4-4.8 EL W30M	White	30000 mm	2.4 - 4.8 mm	1
1513170000	HSS-HF 2.4-4.8 EL Y30M	Yellow	30000 mm	2.4 - 4.8 mm	1
1562880000	HSS-HF 3.2-6.4 EL B30M	Blue	30000 mm	3.2 - 6.4 mm	1
1562980000	HSS-HF 3.2-6.4 EL G30M	Green	30000 mm	3.2 - 6.4 mm	1
1562780000	HSS-HF 3.2-6.4 EL R30M	Red	30000 mm	3.2 - 6.4 mm	1
1513280000	HSS-HF 3.2-6.4 EL W30M	White	30000 mm	3.2 - 6.4 mm	1
1513180000	HSS-HF 3.2-6.4 EL Y30M	Yellow	30000 mm	3.2 - 6.4 mm	1
1562890000	HSS-HF 4.8-9.5 EL B 30M	Blue	30000 mm	4.8 - 9.5 mm	1
1562990000	HSS-HF 4.8-9.5 EL G 30M	Green	30000 mm	4.8 - 9.5 mm	1
1562790000	HSS-HF 4.8-9.5 EL R 30M	Red	30000 mm	4.8 - 9.5 mm	1
1513290000	HSS-HF 4.8-9.5 EL W30M	White	30000 mm	4.8 - 9.5 mm	1
1513190000	HSS-HF 4.8-9.5 EL Y30M	Yellow	30000 mm	4.8 - 9.5 mm	1
1562900000	HSS-HF 6.4-12.7 EL B30M	Blue	30000 mm	6.4 - 12.7 mm	1
1563020000	HSS-HF 6.4-12.7 EL G30M	Green	30000 mm	6.4 - 12.7 mm	1
1562800000	HSS-HF 6.4-12.7 EL R30M	Red	30000 mm	6.4 - 12.7 mm	1
1513300000	HSS-HF 6.4-12.7 EL W30M	White	30000 mm	6.4 - 12.7 mm	1
1513200000	HSS-HF 6.4-12.7 EL Y30M	Yellow	30000 mm	6.4 - 12.7 mm	1
1562920000	HSS-HF 9.5-19.1 EL B30M	Blue	30000 mm	9.5 - 19.1 mm	1
1563030000	HSS-HF 9.5-19.1 EL G30M	Green	30000 mm	9.5 - 19.1 mm	1
1562820000	HSS-HF 9.5-19.1 EL R30M	Red	30000 mm	9.5 - 19.1 mm	1
1513320000	HSS-HF 9.5-19.1 EL W30M	White	30000 mm	9.5 - 19.1 mm	1
1513220000	HSS-HF 9.5-19.1 EL Y30M	Yellow	30000 mm	9.5 - 19.1 mm	1
1562930000	HSS-HF 12.7-25.4 EL B30M	Blue	30000 mm	12.7 - 25.4 mm	1
1563040000	HSS-HF 12.7-25.4 EL G30M	Green	30000 mm	12.7 - 25.4 mm	1
1562830000	HSS-HF 12.7-25.4 EL R30M	Red	30000 mm	12.7 - 25.4 mm	1
1513330000	HSS-HF 12.7-25.4 EL W30M	White	30000 mm	12.7 - 25.4 mm	1
1513230000	HSS-HF 12.7-25.4 EL Y30M	Yellow	30000 mm	12.7 - 25.4 mm	1

Technical data

Machinery

Process

Energy

Transportation

Device  
Manufacturers

Infrastructure

Thermal transfer printer

THM Plus M

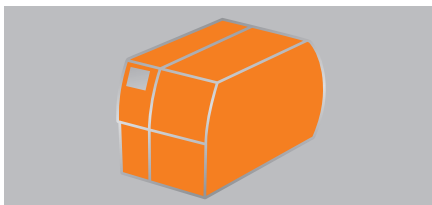

Technical data

EAN	4050118462951
Length	446 mm
Width	242 mm
Height	274 mm
Net weight	9 Kg
Printing method	Thermotransfer
Printer driver / Operating system	Windows 7, Windows 8, Windows 8.1, Windows 10
Printing speed	125 mm/s
Print quality	300
Marker type	Label reel, Shrink sleeves
Interface	LAN, USB
Supply voltage	100...240 V AC
Software	M-Print® PRO
<b>Note</b>	

Ordering data

Type	Qty.	Order No.
THM PLUS M	1	2448870000
<b>Note</b>		

Accessories

Printer ribbons		Type	Qty.	Order No.
	Label, wide, black	RIBBON MM 110/360 SW	1	2005070000
	Label, narrow, black	RIBBON MM 80/360 SW	1	2005080000
	Label, narrow, white	RIBBON MM 80/300 WS	1	2005040000
	Shrink sleeve, endless	RIBBON HSS HF EL 40/300	1	1426210000
	Shrink sleeve, assembled	RIBBON MM-HS 60/300 SW	1	2448880000
<b>Note</b>				

Technical data

Machinery



Process



Energy



Transportation



Device  
Manufacturers



Infrastructure



## Benefit from optimum support when using our new products

### Service connects – worldwide

If our new products are used in your automation technology applications, you need the best possible individual support, from planning through installation to operation.

For every stage of your application, we can offer the right tools and information for our products and solutions. Up-to-date, uncomplicated, comprehensive and around the clock via our service portal at [www.weidmueller.com/service](http://www.weidmueller.com/service).

Fast access to our support and services is available via Weidmüller webcodes. Simply select the service you want on the right hand side, then enter the webcode made up of five digits with a preceding hashtag into the search field in the top right corner of [www.weidmueller.com](http://www.weidmueller.com) and it will bring up the details you need.





# Online support and downloads

## Exactly the right help and information on our solutions and products

From selection through to operation of our solutions and products in your application, you can access our web portal at any time, with a wide range of information material, software, product configurators and much more.

### Engineering Support

As a developer, you need simple processes and system-wide tools. We support you in your development environment with comprehensive data, software tools and interfaces, product selection guides and development samples.



#### Engineering data

Webcode #01219



#### Engineering software

Webcode #11377



#### Produkt software

Webcode #01212



#### Product configurators, product selection guides and samples

Webcode #01214



#### Whitepaper for device connectivity

Webcode #11359

### Technical data and downloads

Download all the documents and software relating to our products by simply entering the item number. You can also view our Online Catalogue and research the technical properties of our products.



#### Find downloads

Webcode #11379



#### Products in the Online Catalogue

Webcode #01217

## Commercial support

Integrate our product data into your commercial system using standardised interfaces or familiarise yourself with the wide range of products in our technical catalogues.



### Electronic catalogue in BMECat format and other formats

Webcode #11378



### Technical catalogue in PDF Format

Webcode #01218



### Access our Webshop

Webcode #11382

## More offers in online support and downloads

Not found what you are looking for? We have even more to offer you in online support and downloads.



### Approvals, certificates and declaration of conformity

Webcode #11374

Here you will find information on the CE declaration of conformity, on RoHS and REACH and other company related certificates and approvals.

## All Weidmüller online services

Simply scan the QR code  
or visit our service portal at  
[www.weidmueller.com/service](http://www.weidmueller.com/service)



Let's connect.

There, you can  
find all our online  
support services  
and direct contact  
details for your local  
contact.

You can also visit our Products section, the Online Catalogue or find suitable solutions in our Industries section. If you have questions or can't find what you are looking for, please contact our personal support.

# Index

---

<b>Index</b>	Index Type	X.2
	Index Order No.	X.10
	Addresses worldwide	X.20

---





Type	Order No.	Page
DEK 5/5 PLUS MC NE WS	1854490000	T.44
DEK 5/5 PLUS MC NE WS	1854490000	T.53
DEK 5/5 PLUS MC NE WS	1854490000	T.55
DEK 5/6 MM WS	2007120000	T.8
DEK 5/6 MM WS	2007120000	T.9
DEK 5/6 MM WS	2007120000	T.9
DEK 5/6 MM WS	2007120000	T.19
DEK 5/6 MM WS	2007120000	T.19
DEK 5/6 MM WS	2007120000	T.20
DEK 5/6 MM WS	2007120000	T.22
DEK 5/6 MM WS	2007120000	T.26
DEK 5/6 MM WS	2007120000	T.57
DEK 5/6 MM WS	2007120000	T.58
DEK 5/6 MM WS	2007120000	T.58
DEK 5/6 PLUS MC NE WS	1011320000	T.61
DEK 5/6 PLUS MC NE WS	1011320000	T.8
DEK 5/6 PLUS MC NE WS	1011320000	T.9
DEK 5/6 PLUS MC NE WS	1011320000	T.9
DEK 5/6 PLUS MC NE WS	1011320000	T.19
DEK 5/6 PLUS MC NE WS	1011320000	T.19
DEK 5/6 PLUS MC NE WS	1011320000	T.20
DEK 5/6 PLUS MC NE WS	1011320000	T.22
DEK 5/6 PLUS MC NE WS	1011320000	T.26
DEK 5/6 PLUS MC NE WS	1011320000	T.57
DEK 5/6 PLUS MC NE WS	1011320000	T.58
DEK 5/6 PLUS MC NE WS	1011320000	T.58
DEK 5/6 PLUS MC NE WS	1011320000	T.61
DEK 5/8 PLUS MC NE WS	1046350000	T.10
DEK 5/8 PLUS MC NE WS	1046350000	T.10
DEK 5/8 PLUS MC NE WS	1046350000	T.20
DEK 5/8 PLUS MC NE WS	1046350000	T.21
DEK 5/8 PLUS MC NE WS	1046350000	T.48
DEK 5/8 PLUS MC NE WS	1046350000	T.48
DEK 5/8 PLUS MC NE WS	1046350000	T.50
DEK 5/8 PLUS MC NE WS	1046350000	T.50
DEK 5/8-11.5 MC NE WS	1341630000	T.84
DEK 5/8-11.5 MC NE WS	1341630000	T.85
DEK 5/8-11.5 MC NE WS	1341630000	T.87
DEK 5/8-11.5 MC NE WS	1341630000	T.88
DEK 5/8-11.5 MC SDR	1341610000	T.84
DEK 5/8-11.5 MC SDR	1341610000	T.85
DEK 5/8-11.5 MC SDR	1341610000	T.87
DEK 5/8-11.5 MC SDR	1341610000	T.88
DEKA 5/8 MM WS	2448860000	T.10
DEKA 5/8 MM WS	2448860000	T.11
DEKA 5/8 MM WS	2448860000	T.20
DEKA 5/8 MM WS	2448860000	T.21
DEKA 5/8 MM WS	2448860000	T.48
DEKA 5/8 MM WS	2448860000	T.48
DEKA 5/8 MM WS	2448860000	T.50
DEKA 5/8 MM WS	2448860000	T.50
DG DO P76	4323240000	T.90
DMS MANUELL 0,5-1,7	9918370000	T.115
DMS MANUELL 2,0-9,0	9918380000	T.115

## E

Type	Order No.	Page
ENERGY ANALYSER D550-24	2489780000	T.94
EPG 60	2453810000	T.190
EPG CUT 40	2453830000	T.192
ES EPG 60 DIN 10	2505290000	T.191
ES EPG 60 DIN 120	2505360000	T.191
ES EPG 60 DIN 16	2505300000	T.191
ES EPG 60 DIN 25	2505310000	T.191
ES EPG 60 DIN 35	2505320000	T.191
ES EPG 60 DIN 50	2505330000	T.191
ES EPG 60 DIN 6	2505280000	T.191
ES EPG 60 DIN 7	2505340000	T.191
ES EPG 60 DIN 95	2505350000	T.191
ES EPG 60 HEX 10	2505160000	T.191
ES EPG 60 HEX 120	2505230000	T.191
ES EPG 60 HEX 150	2505240000	T.191
ES EPG 60 HEX 16	2505170000	T.191
ES EPG 60 HEX 185	2505250000	T.191
ES EPG 60 HEX 240	2505260000	T.191
ES EPG 60 HEX 25	2505180000	T.191
ES EPG 60 HEX 300	2505270000	T.191
ES EPG 60 HEX 35	2505190000	T.191
ES EPG 60 HEX 50	2505200000	T.191
ES EPG 60 HEX 6	2505150000	T.191
ES EPG 60 HEX 70	2505210000	T.191
ES EPG 60 HEX 95	2505220000	T.191
ES EPG 60 WM 10	2469540000	T.191
ES EPG 60 WM 120	2469610000	T.191
ES EPG 60 WM 150	2469620000	T.191
ES EPG 60 WM 16	2469550000	T.191
ES EPG 60 WM 185	2469630000	T.191
ES EPG 60 WM 240	2469640000	T.191
ES EPG 60 WM 25	2469560000	T.191
ES EPG 60 WM 300	2469570000	T.191
ES EPG 60 WM 35	2469570000	T.191
ES EPG 60 WM 50	2469580000	T.191
ES EPG 60 WM 6	2469590000	T.191
ES EPG 60 WM 70	2469600000	T.191
ESG 7/20 SIRIUS MC NE WS	1736181044	T.152
ESG 7/20 SIRIUS MC NE WS	1736181044	T.153
ESG 7/20 SIRIUS MC NE WS	1736181044	T.154
ESG 7/20 SIRIUS MC NE WS	1736181044	T.156

Type	Order No.	Page
ESG 7/20 SIRIUS MC NE WS	1736181044	T.156
ESG 7/20 SIRIUS MC NE WS	1736181044	T.157
ESG 7/20 SIRIUS MC NE WS	1736181044	T.157
ESG 7/20 SIRIUS MC NE WS	1736181044	T.158
ESG 7/20 SIRIUS MC NE WS	1736181044	T.158
ESG 7/20 SIRIUS MC NE WS	1736181044	T.159
ESG 7/20 SIRIUS MC NE WS	1736181044	T.159
ESO UR20 DIN A4 WS	1429430000	T.84
ESO UR20 DIN A4 WS	1429430000	T.85
ESO UR20 DIN A4 WS	1429430000	T.87
ESO UR20 DIN A4 WS	1429430000	T.88

## F

Type	Order No.	Page
FAD 1771-WA/WC SL10 M	2448650000	T.118
FAD 1771-WB/WD SL12 M	2448680000	T.118
FAD 1771-WF SL18 M	2448690000	T.119
FAD 1771-WH/WG SL21 M	2448660000	T.119
FAD 1771-WN 2SL20 M	2448670000	T.120
FP Box ON/OFF16A FUSE R	8000028513	T.90

## G

Type	Order No.	Page
G 20/0.25A/F	0430500000	T.58
G 20/0.25A/F	0430500000	T.61
G 20/0.50A/F	0430600000	T.58
G 20/0.50A/F	0430600000	T.61
G 20/1.00A/F	0430700000	T.58
G 20/1.00A/F	0430700000	T.61
G 20/2.00A/F	0430900000	T.58
G 20/2.00A/F	0430900000	T.61
G 20/2.00A/F	0430900000	T.126

## H

Type	Order No.	Page
HDC C HX BM1.5AG	1002950000	T.131
HDC C HX BM1.5AG	1002950000	T.132
HDC C HX BM2.5AG	1002960000	T.131
HDC C HX BM2.5AG	1002960000	T.132
HDC C HX BM4.0AG	1002970000	T.131
HDC C HX BM4.0AG	1002970000	T.132
HDC C HX BM6.0AG	1002980000	T.131
HDC C HX BM6.0AG	1002980000	T.132
HDC C HX SM1.5AG	1002910000	T.131
HDC C HX SM1.5AG	1002910000	T.132
HDC C HX SM2.5AG	1002920000	T.131
HDC C HX SM2.5AG	1002920000	T.132
HDC C HX SM4.0AG	1002930000	T.131
HDC C HX SM4.0AG	1002930000	T.132
HDC C HX SM6.0AG	1002940000	T.131
HDC C HX SM6.0AG	1002940000	T.132
HDC C MHX BM10.0AG	2494560000	T.132
HDC C MHX SM10.0AG	2494560000	T.132
HDC MBUS 2 MC	1429202000	T.139
HDC MBUS 2 MC	1429299000	T.139
HDC MBUS 2 PCLIP	1989290000	T.139
HDC MBUS 2 PCLIP	1989300000	T.139
HDC MDU	1429040000	T.140
HDC MF 10B AC	1428960000	T.128
HDC MF 10B AC	1428980000	T.128
HDC MF 16B AD	1429010000	T.129
HDC MF 16B DA	1429030000	T.129
HDC MF 24B AF	1429050000	T.129
HDC MF 24B FA	1429070000	T.129
HDC MF 6B AB	1428920000	T.128
HDC MF 6B BA	1428940000	T.128
HDC MF FIXING	1480290000	T.128
HDC MF FIXING	1480290000	T.128
HDC MF FIXING	1480290000	T.129
HDC MF FIXING	1480290000	T.129
HDC MHD 12 FC	1428850000	T.138
HDC MHD 12 MC	1428840000	T.138
HDC MHD 36 FC	1428870000	T.137
HDC MHD 36 MC	1428860000	T.137
HDC MHE 20 FC	1428930000	T.134
HDC MHE 20 MC	1428910000	T.134
HDC MHE 6 FC	1429370000	T.136
HDC MHE 6 MC	1429360000	T.136
HDC MHE 6P FC	1505660000	T.133
HDC MHE 6P MC	1505650000	T.133
HDC MHE 8 FC	1428890000	T.135
HDC MHE 8 MC	1428880000	T.135
HDC MHP 100 FC	1429080000	T.130
HDC MHP 100 MC	1429060000	T.130
HDC MHP REMOVAL TOOL	1480380000	T.130
HDC MHP100 F 10	1435790000	T.130
HDC MHP100 F 16	1435810000	T.130
HDC MHP100 F 25	1435820000	T.130
HDC MHP100 F 35	1435830000	T.130
HDC MHP100 M 10	1435750000	T.130
HDC MHP100 M 16	1435760000	T.130
HDC MHP100 M 25	1435770000	T.130
HDC MHP100 M 35	1435780000	T.130
HDC MHX 3 FC	1429350000	T.132
HDC MHX 3 MC	1429340000	T.132
HDC MHX 4P FC	1428970000	T.131
HDC MHX 4P MC	1428950000	T.131
HDC XX5E01 FMSM12D-0100	2451120100	T.142
HDC XX5E01 FMSR145-0100	2451080100	T.142

Type	Order No.	Page
HDC XX5E01 FOXXXX-0100	2003920100	T.142
HDC XX5E01 MFSXXX-0050	2453550050	T.142
HDC XX5E01 MFSXXX-0100	2453550100	T.142
HDC XX5E01 MFSXXX-0150	2453550150	T.142
HDC XX5E01 MFSXXX-0300	2453550300	T.142
HDC XX5E01 MFSXXX-0500	2453550500	T.142
HDC XX5E01 MMSM12D-0100	2451110100	T.142
HDC XX5E01 MMSR145-0100	2450490100	T.142
HDC XX5E01 MOXXXX-0100	2003890100	T.142
HDC XX6A01 FMSM12X-0100	2451140100	T.143
HDC XX6A01 FMSR145-0100	2451100100	T.143
HDC XX6A01 FOXXXX-0100	2003850100	T.143
HDC XX6A01 MFSXXX-0050	2453540050	T.143
HDC XX6A01 MFSXXX-0100	2453540100	T.143
HDC XX6A01 MFSXXX-0150	2453540150	T.143
HDC XX6A01 MFSXXX-0300	2453540300	T.143
HDC XX6A01 MFSXXX-0500	2453540500	T.143
HDC XX6A01 MMSM12X-0100	2451130100	T.143
HDC XX6A01 MMSR145-0100	2451090100	T.143
HDC XX6A01 MOXXXX-0100	2003820100	T.143
HDC C-HD-BM0.14-0.37AG	1651570000	T.137
HDC C-HD-BM0.14-0.37AG	1651570000	T.138
HDC C-HD-BM0.14-0.37AG	1651670000	T.137
HDC C-HD-BM0.14-0.37AG	1651670000	T.138
HDC C-HD-BM0.5AG	1651580000	T.137
HDC C-HD-BM0.5AG	1651580000	T.138
HDC C-HD-BM0.5AG	1651680000	T.137
HDC C-HD-BM0.5AG	1651680000	T.138
HDC C-HD-BM0.75-1.00AG	1601760000	T.137
HDC C-HD-BM0.75-1.00AG	1601760000	T.138
HDC C-HD-BM0.75-1.00AG	1651690000	T.137
HDC C-HD-BM0.75-1.00AG	1651690000	T.138
HDC C-HD-BM1.5AG	1651600000	T.137
HDC C-HD-BM1.5AG	1651600000	T.138
HDC C-HD-BM1.5AG	1651700000	T.137
HDC C-HD-BM1.5AG	1651700000	T.138
HDC C-HD-BM2.5AG	1651610000	T.137
HDC C-HD-BM2.5AG	1651610000	T.138
HDC C-HD-BM2.5AG	1651710000	T.137
HDC C-HD-BM2.5AG	1651710000	T.138
HDC C-HD-SM0.14-0.37AG	1651520000	T.137
HDC C-HD-SM0.14-0.37AG	1651520000	T.138
HDC C-HD-SM0.14-0.37AG	1651620000	T.137
HDC C-HD-SM0.14-0.37AG	1651620000	T.138
HDC C-HD-SM0.5AG	1651530000	T.137
HDC C-HD-SM0.5AG	1651530000	T.138
HDC C-HD-SM0.5AG	1651630000	T.137
HDC C-HD-SM0.5AG	1651630000	T.138
HDC C-HD-SM0.75-1.00AG	1601750000	T.137
HDC C-HD-SM0.75-1.00AG	1601750000	T.138
HDC C-HD-SM0.75-1.00AG	1651640000	T.137
HDC C-HD-SM0.75-1.00AG	1651640000	T.138
HDC C-HD-SM1.5AG	1651550000	T.137
HDC C-HD-SM1.5AG	1651550000	T.138
HDC C-HD-SM1.5AG	1651650000	T.137
HDC C-HD-SM1.5AG	1651650000	T.138
HDC C-HD-SM2.5AG	1651560000	T.137
HDC C-HD-SM2.5AG	1651560000	T.138
HDC C-HD-SM2.5AG	1651660000	T.137
HDC C-HD-SM2.5AG	1651660000	T.138
HDC C-HD-SM2.5AG	1651660000	T.138
HDC C-HD-SM2.5AG	1651660000	T.139
HDC C-HD-SM2.5AG	1651660000	T.139
HDC C-HD-SM2.5AG	1651660000	T.139
HDC C-HD-SM2.5AG	1651660000	T.140
HDC C-HD-SM2.5AG	1651660000	T.140
HDC C-HD-SM2.5AG	1651660000	T.142
HDC C-HD-SM2.5AG	1651660000	T.142
HDC C-HD-SM2.5AG	1651660000	T.143
HDC C-HD-SM2.5AG	1651660000	T.143
HDC C-HD-SM2.5AG	1651660000	T.144
HDC C-HD-SM2.5AG	1651660000	T.144
HDC C-HD-SM2.5AG	1651660000	T.145
HDC C-HD-SM2.5AG	1651660000	T.145
HDC C-HD-SM2.5AG	1651660000	T.146
HDC C-HD-SM2.5AG	1651660000	T.146
HDC C-HD-SM2.5AG	1651660000	T.147
HDC C-HD-SM2.5AG	1651660000	T.147
HDC C-HD-SM2.5AG	1651660000	T.148
HDC C-HD-SM2.5AG		



Type	Order No.	Page
PS 2.0 MC	0310000000	T.9
PS 2.0 MC	0310000000	T.9
PS 2.0 MC	0310000000	T.10
PS 2.0 MC	0310000000	T.10
PS 2.0 MC	0310000000	T.11
PS 2.0 MC	0310000000	T.12
PS 2.0 MC	0310000000	T.13
PS 2.0 MC	0310000000	T.13
PS 2.0 MC	0310000000	T.14
PS 2.0 MC	0310000000	T.14
PS 2.0 MC	0310000000	T.15
PS 2.0 MC	0310000000	T.16
PS 2.0 MC	0310000000	T.17
PS 2.0 MC	0310000000	T.17
PS 2.0 MC	0310000000	T.18
PS 2.0 MC	0310000000	T.19
PS 2.0 MC	0310000000	T.20
PS 2.0 MC	0310000000	T.20
PS 2.0 MC	0310000000	T.21
PS 2.0 MC	0310000000	T.21
PS 2.0 MC	0310000000	T.21
PS 2.0 MC	0310000000	T.22
PS 2.0 MC	0310000000	T.22
PS 2.0 MC	0310000000	T.23
PS 2.0 MC	0310000000	T.23
PS 2.0 MC	0310000000	T.24
PS 2.0 MC	0310000000	T.24
PS 2.0 MC	0310000000	T.25
PS 2.0 MC	0310000000	T.25
PS 2.0 MC	0310000000	T.26
PS 2.0 MC	0310000000	T.26
PS 2.0 MC	0310000000	T.27
PS 2.0 MC	0310000000	T.27
PS 2.0 MC	0310000000	T.29
PS 2.0 MC	0310000000	T.30
PS 2.0 MC	0310000000	T.31
PS 2.0 MC	0310000000	T.44
PS 2.0 MC	0310000000	T.46
PS 2.0 MC	0310000000	T.46
PS 2.0 MC	0310000000	T.47
PS 2.0 MC	0310000000	T.47
PS 2.0 MC	0310000000	T.48
PS 2.0 MC	0310000000	T.48
PS 2.0 MC	0310000000	T.50
PS 2.0 MC	0310000000	T.50
PS 2.0 MC	0310000000	T.52
PS 2.0 MC	0310000000	T.52
PS 2.0 MC	0310000000	T.54
PS 2.0 MC	0310000000	T.54
PS 2.0 MC	0310000000	T.56
PS 2.0 MC	0310000000	T.56
PS 2.0 MC	0310000000	T.57
PS 2.0 MC	0310000000	T.58
PS 2.0 MC	0310000000	T.60
PS 2.0 MC	0310000000	T.60
PS 2.0 MC	0310000000	T.178
PS 2.0 MC	0310000000	T.180
PS 2.0 MC	0310000000	T.181
PS 2.0 MC	0310000000	T.182
PS 2.0 MC	0310000000	T.183
PS 2.0 MC	0310000000	T.184
PS 2.0 MC	0310000000	T.186
PS 2.0 MC	0310000000	T.187
PVC-TV1-BK-4-1000	1203780000	T.115
PVC-TV1-BK-6-1000	1524740000	T.115
PWZ RJ45	1118040000	T.160

## R

REMOVAL TOOL HD	1866730000	T.137
REMOVAL TOOL HD	1866730000	T.138
Removal Tool HE	1866750000	T.133
Removal Tool HE	1866750000	T.134
Removal Tool HE	1866750000	T.136
Removal Tool HE	1866750000	T.135
Removal Tool HX	1002990000	T.131
Removal Tool HX	1002990000	T.132
RIBBON HSS HF EL 40/300	1426210000	T.200
RIBBON HSS HF EL 40/300	1426210000	T.200
RIBBON HSS HF EL 40/300	1426210000	T.201
RIBBON HSS HF EL 40/300	1426210000	T.201
RIBBON HSS HF EL 40/300	1426210000	T.202
RIBBON HSS HF EL 40/300	1426210000	T.202
RIBBON HSS HF EL 40/300	1426210000	T.203
RIBBON MM 110/360 SW	2005070000	T.203
RIBBON MM 80/300 WS	2005040000	T.203
RIBBON MM 80/360 SW	2005080000	T.203
RIBBON MM-HS 60/300 SW	2448880000	T.198
RIBBON MM-HS 60/300 SW	2448880000	T.198
RIBBON MM-HS 60/300 SW	2448880000	T.199

Type	Order No.	Page
RIBBON MM-HS 60/300 SW	2448880000	T.199
RIBBON MM-HS 60/300 SW	2448880000	T.203
RKDG D11 PT6	4323210000	T.90
RKDG D13 PT6	4323230000	T.90
RKDG D15 PT6	4323220000	T.90
RKDG D17 PT6	4324010000	T.90
RKDG D9 PT6	4329610000	T.90
RS PLC IPC-620 12-points	6720000787	T.122
RS PLC IPC-620 22-points	6720000788	T.122
RS PLC IPC-620 24-points	6720001226	T.124
RS PLC IPC-620 38-points	6720001225	T.123
RSS112024	4061590000	T.128

## S

SAIL-M12BG-K-1.5P	2455150150	T.146
SAIL-M12BG-K-10P	2455151000	T.146
SAIL-M12BG-K-3.0P	2455150300	T.146
SAIL-M12BG-K-5.0P	2455150500	T.146
SAIL-M12BG-L-1.5P	2455330150	T.144
SAIL-M12BG-L-10P	2455331000	T.144
SAIL-M12BG-L-3.0P	2455330300	T.144
SAIL-M12BG-L-5.0P	2455330500	T.144
SAIL-M12BG-S-1.5P	2050160150	T.148
SAIL-M12BG-S-10P	2050161000	T.148
SAIL-M12BG-S-3.0P	2050160300	T.148
SAIL-M12BG-S-1.5P	2049950150	T.148
SAIL-M12BG-S3-10P	2049951000	T.148
SAIL-M12BG-S3-3.0P	2049950300	T.148
SAIL-M12BG-S3-5.0P	2049950500	T.148
SAIL-M12BG-S-5.0P	2050160500	T.148
SAIL-M12BG-T-1.5H	2050680150	T.150
SAIL-M12BG-T-1.5P	2050490150	T.150
SAIL-M12BG-T-10H	2050681000	T.150
SAIL-M12BG-T-10P	2050491000	T.150
SAIL-M12BG-T-3.0H	2050680300	T.150
SAIL-M12BG-T-3.0P	2050490300	T.150
SAIL-M12BG-T-5.0H	2050680500	T.150
SAIL-M12BG-T-5.0P	2050490500	T.150
SAIL-M12BW-K-1.5P	2455190150	T.146
SAIL-M12BW-K-10P	2455191000	T.146
SAIL-M12BW-K-3.0P	2455190300	T.146
SAIL-M12BW-K-5.0P	2455190500	T.146
SAIL-M12BW-L-1.5P	2455200150	T.144
SAIL-M12BW-L-10P	2455201000	T.144
SAIL-M12BW-L-3.0P	2455200300	T.144
SAIL-M12BW-L-5.0P	2455200500	T.144
SAIL-M12BW-S-1.5P	2050210150	T.148
SAIL-M12BW-S-10P	2050211000	T.148
SAIL-M12BW-S-3.0P	2050210300	T.148
SAIL-M12BW-S3-1.5P	2050010150	T.148
SAIL-M12BW-S3-10P	2050011000	T.148
SAIL-M12BW-S3-3.0P	2050010300	T.148
SAIL-M12BW-S3-5.0P	2050010500	T.148
SAIL-M12BW-S-5.0P	2050210500	T.148
SAIL-M12BW-T-1.5H	2050680150	T.150
SAIL-M12BW-T-1.5P	2050560150	T.150
SAIL-M12BW-T-10H	2050681000	T.150
SAIL-M12BW-T-10P	2050561000	T.150
SAIL-M12BW-T-3.0H	2050680300	T.150
SAIL-M12BW-T-3.0P	2050560300	T.150
SAIL-M12BW-T-5.0H	2050680500	T.150
SAIL-M12BW-T-5.0P	2050560500	T.150
SAIL-M12G-K-1.5P	2455210150	T.146
SAIL-M12G-K-10P	2455211000	T.146
SAIL-M12G-K-3.0P	2455210300	T.146
SAIL-M12G-L-1.5P	2455250150	T.147
SAIL-M12G-L-10P	2455251000	T.147
SAIL-M12G-L-3.0P	2455250300	T.147
SAIL-M12G-L-5.0P	2455250500	T.147
SAIL-M12G-M12G-K-10P	2455250150	T.147
SAIL-M12G-M12G-K-3.0P	2455250300	T.147
SAIL-M12G-M12G-L-1.5P	2455250150	T.147
SAIL-M12G-M12G-L-10P	2455251000	T.147
SAIL-M12G-M12G-L-3.0P	2455250300	T.147
SAIL-M12G-M12G-L-5.0P	2455250500	T.147
SAIL-M12G-M12G-S-1.5P	2455250150	T.147
SAIL-M12G-M12G-S-10P	2455251000	T.147
SAIL-M12G-M12G-S-3.0P	2455250300	T.147
SAIL-M12G-M12G-S-5.0P	2455250500	T.147
SAIL-M12G-M12W-K-10P	2455270150	T.151
SAIL-M12G-M12W-K-3.0P	2455270300	T.151
SAIL-M12G-M12W-K-5.0P	2455270500	T.151
SAIL-M12G-M12W-K-1.5P	2455270150	T.147
SAIL-M12G-M12W-L-1.5P	2455250150	T.147
SAIL-M12G-M12W-L-10P	2455251000	T.147
SAIL-M12G-M12W-L-3.0P	2455250300	T.147
SAIL-M12G-M12W-L-5.0P	2455250500	T.147
SAIL-M12G-M12W-S-1.5P	2455250150	T.147
SAIL-M12G-M12W-S-10P	2455251000	T.147
SAIL-M12G-M12W-S-3.0P	2455250300	T.147
SAIL-M12G-M12W-S-5.0P	2455250500	T.147
SAIL-M12G-M12W-T-1.5H	2455250150	T.147
SAIL-M12G-M12W-T-1.5P	2455251000	T.147
SAIL-M12G-M12W-T-10H	2455251000	T.147
SAIL-M12G-M12W-T-10P	2455251000	T.147
SAIL-M12G-M12W-T-3.0H	2455250300	T.147
SAIL-M12G-M12W-T-3.0P	2455250300	T.147
SAIL-M12G-M12W-T-5.0H	2455250500	T.147
SAIL-M12G-M12W-T-5.0P	2455250500	T.147
SAIL-M12G-S-1.5P	2050230150	T.148
SAIL-M12G-S-10P	2050231000	T.148
SAIL-M12G-S-3.0P	2050230300	T.148
SAIL-M12G-S3-1.5P	2050020150	T.148
SAIL-M12G-S3-10P	2050021000	T.148
SAIL-M12G-S3-3.0P	2050020300	T.148
SAIL-M12G-S3-5.0P	2050020500	T.148
SAIL-M12G-T-1.5H	2050700150	T.150
SAIL-M12G-T-1.5P	2050640150	T.150
SAIL-M12G-T-10H	2050701000	T.150
SAIL-M12G-T-10P	2050641000	T.150
SAIL-M12G-T-3.0H	2050700300	T.150
SAIL-M12G-T-3.0P	2050640300	T.150
SAIL-M12G-T-5.0H	2050700500	T.150
SAIL-M12G-T-5.0P	2050640500	T.150
SAIL-M12W-K-1.5P	2455230150	T.146
SAIL-M12W-K-10P	2455231000	T.146
SAIL-M12W-K-3.0P	2455230300	T.146
SAIL-M12W-K-5.0P	2455230500	T.146
SAIL-M12W-L-1.5P	2455240150	T.144
SAIL-M12W-L-10P	2455241000	T.144
SAIL-M12W-L-3.0P	2455240300	T.144
SAIL-M12W-L-5.0P	2455240500	T.144
SAIL-M12WM-12G-K-1.5P	2455310150	T.147
SAIL-M12WM-12G-K-10P	2455310300	T.147
SAIL-M12WM-12G-K-3.0P	2455310500	T.147
SAIL-M12WM-12G-L-1.5P	2455320150	T.145
SAIL-M12WM-12G-L-10P	2455321000	T.145
SAIL-M12WM-12G-L-3.0P	2455320300	T.145
SAIL-M12WM-12G-L-5.0P	2455320500	T.145
SAIL-M12WM-12G-S-1.5P	2050350150	T.149
SAIL-M12WM-12G-S-10P	2050351000	T.149
SAIL-M12WM-12G-S-3.0P	2050350300	T.149
SAIL-M12WM-12G-S3-1.5P	2050080150	T.149
SAIL-M12WM-12G-S3-10P	2050081000	T.149
SAIL-M12WM-12G-S3-3.0P	2050080300	T.149
SAIL-M12WM-12G-S3-5.0P	2050080500	T.149
SAIL-M12WM-12G-S-5.0P	2050350500	T.149
SAIL-M12WM-12G-T-1.5H	2050890150	T.151
SAIL-M12WM-12G-T-1.5P	2050820150	T.151
SAIL-M12WM-12G-T-10H	2050891000	T.151
SAIL-M12WM-12G-T-10P	2050821000	T.151
SAIL-M12WM-12G-T-3.0H	2050890300	T.151
SAIL-M12WM-12G-T-3.0P	2050820300	T.151
SAIL-M12WM-12G-T-5.0H	2050890500	T.151
SAIL-M12WM-12G-T-5.0P	2050820500	T.151
SAIL-M12WM-12W-K-1.5P	2455290150	T.147
SAIL-M12WM-12W-K-3.0P	2455291000	T.147
SAIL-M12WM-12W-K-5.0P	2455290300	T.147
SAIL-M12WM-12W-K-1.5P	2455290500	T.147
SAIL-M12WM-12W-L-1.5P	2455300150	T.145
SAIL-M12WM-12W-L-10P	2455301000	T.145
SAIL-M12WM-12W-L-3.0P	2455300300	T.145
SAIL-M12WM-12W-L-5.0P	2455300500	T.145
SAIL-M12WM-12W-S-1.5P	2050470150	T.149
SAIL-M12WM-12W-S-10P	2050471000	T.149
SAIL-M12WM-12W-S-3.0P	2050470300	T.149
SAIL-M12WM-12W-S3-1.5P	2050150150	T.149
SAIL-M12WM-12W-S3-10P	2050151000	T.149
SAIL-M12WM-12W-S3-3.0P	2050150300	T.149
SAIL-M12WM-12W-S3-5.0P	2050150500	T.149
SAIL-M12WM-12W-S-5.0P	2050470500	T.149
SAIL-M12WM-12W-T-1.5H	2050920150	T.151
SAIL-M12WM-12W-T-1.5P	2050860150	T.151
SAIL-M12WM-12W-T-10H	2050921000	T.151
SAIL-M12WM-12W-T-10P	2050861000	T.151
SAIL-M12WM-12W-T-3.0H	2050920300	T.151
SAIL-M12WM-12W-T-3.0P	2050860300	T.151
SAIL-M12WM-12W-T-5.0H	2050920500	T.151
SAIL-M12WM-12W-T-5.0P	2050860500	T.151
SAIL-M12W-S-1.5P	2050260150	T.148
SAIL-M12W-S-10P	2050261000	T.148
SAIL-M12W-S-3.0P	2050260300	T.148
SAIL-M12W-S3-1.5P	2050050150	T.148
SAIL-M12W-S3-10P	2050051000	T.148
SAIL-M12W-S3-3.0P	2050050300	T.148
SAIL-M12W-S3-5.0P	2050050500	T.148

Type	Order No.	Page
SAIL-M12GM12W-L-1.5P	2455280150	T.145
SAIL-M12GM12W-L-10P	2455281000	T.145
SAIL-M12GM12W-L-3.0P	2455280300	T.145
SAIL-M12GM12W-L-5.0P	2455280500	T.145
SAIL-M12GM12W-S-1.5P	2050460150	T.149
SAIL-M12GM12W-S-10P	2050461000	T.149
SAIL-M12GM12		





Type	Order No.	Page	Type	Order No.	Page	Type	Order No.	Page	Type	Order No.	Page
ZEW 35	9540000000	T.28	ZDV 1.5N/20 BL	1985700000	T.34	ZDV 2.5N/2 BL	1527740000	T.52	ZDV 4N/2 RD	2460450000	T.73
ZEW 35	9540000000	T.28	ZDV 1.5N/20 RD	1985810000	T.34	ZDV 2.5N/2 BL	1527740000	T.53	ZDV 4N/2 RD	2460450000	T.80
ZEW 35	9540000000	T.29	ZDV 1.5N/3	1985480000	T.34	ZDV 2.5N/2 BL	1527740000	T.54	ZDV 4N/2 RD	2460450000	T.81
ZEW 35	9540000000	T.29	ZDV 1.5N/3 BL	1985560000	T.34	ZDV 2.5N/2 BL	1527740000	T.54	ZDV 4N/2 RD	2460450000	T.82
ZEW 35	9540000000	T.46	ZDV 1.5N/3 RD	1985670000	T.34	ZDV 2.5N/2 BL	1527740000	T.55	ZDV 4N/2 RD	2460450000	T.83
ZEW 35	9540000000	T.46	ZDV 1.5N/4	1985490000	T.34	ZDV 2.5N/2 RD	2108470000	T.34	ZDV 4N/3	1527940000	T.34
ZEW 35	9540000000	T.47	ZDV 1.5N/4 BL	1985570000	T.34	ZDV 2.5N/2 RD	2108470000	T.52	ZDV 4N/3	1527940000	T.83
ZEW 35	9540000000	T.47	ZDV 1.5N/4 RD	1985690000	T.34	ZDV 2.5N/2 RD	2108470000	T.53	ZDV 4N/3 BL	1528080000	T.34
ZEW 35	9540000000	T.47	ZDV 1.5N/5	1985500000	T.34	ZDV 2.5N/2 RD	2108470000	T.54	ZDV 4N/3 BL	1528080000	T.83
ZEW 35	9540000000	T.61	ZDV 1.5N/5 BL	1985590000	T.34	ZDV 2.5N/2 RD	2108470000	T.54	ZDV 4N/3 RD	2460810000	T.34
ZEW 35/2	8630740000	T.12	ZDV 1.5N/5 RD	1985710000	T.34	ZDV 2.5N/2 RD	2108470000	T.55	ZDV 4N/3 RD	2460810000	T.83
ZEW 35/2	8630740000	T.12	ZDV 1.5N/50	1985620000	T.34	ZDV 2.5N/20	1527720000	T.34	ZDV 4N/4	1527970000	T.34
ZEW 35/2	8630740000	T.13	ZDV 1.5N/50 BL	1985720000	T.34	ZDV 2.5N/20 BL	1527890000	T.34	ZDV 4N/4	1527970000	T.83
ZEW 35/2	8630740000	T.13	ZDV 1.5N/50 RD	1985820000	T.34	ZDV 2.5N/20 RD	2108920000	T.34	ZDV 4N/4 BL	1528120000	T.34
ZEW 35/2	8630740000	T.13	ZDV 1.5N/6	1985510000	T.34	ZDV 2.5N/3	1527570000	T.34	ZDV 4N/4 BL	1528120000	T.83
ZEW 35/2	8630740000	T.14	ZDV 1.5N/6 BL	1985610000	T.34	ZDV 2.5N/3 BL	1527770000	T.34	ZDV 4N/4 RD	2460800000	T.34
ZEW 35/2	8630740000	T.14	ZDV 1.5N/6 RD	1985730000	T.34	ZDV 2.5N/3 RD	2108690000	T.34	ZDV 4N/4 RD	2460800000	T.83
ZEW 35/2	8630740000	T.15	ZDV 1.5N/7	1985520000	T.34	ZDV 2.5N/4	1527590000	T.34	ZDV 4N/5	1527980000	T.34
ZEW 35/2	8630740000	T.15	ZDV 1.5N/7 BL	1985630000	T.34	ZDV 2.5N/4 BL	1527780000	T.34	ZDV 4N/5	1527980000	T.83
ZEW 35/2	8630740000	T.21	ZDV 1.5N/7 RD	1985750000	T.34	ZDV 2.5N/4 RD	2108700000	T.34	ZDV 4N/5 BL	1528140000	T.34
ZEW 35/2	8630740000	T.21	ZDV 1.5N/8	1985540000	T.34	ZDV 2.5N/5	1527620000	T.34	ZDV 4N/5 BL	1528140000	T.83
ZEW 35/2	8630740000	T.29	ZDV 1.5N/8 BL	1985640000	T.34	ZDV 2.5N/5 BL	1527790000	T.34	ZDV 4N/5 RD	2460790000	T.34
ZEW 35/2	8630740000	T.30	ZDV 1.5N/8 RD	1985770000	T.34	ZDV 2.5N/5 RD	2108710000	T.34	ZDV 4N/5 RD	2460790000	T.83
ZEW 35/2	8630740000	T.30	ZDV 1.5N/9	1985560000	T.34	ZDV 2.5N/50	1527730000	T.34	ZDV 4N/50	1528130000	T.34
ZEW 35/2	8630740000	T.31	ZDV 1.5N/9 BL	1985660000	T.34	ZDV 2.5N/50 BL	1527920000	T.34	ZDV 4N/50	1528130000	T.71
ZEW 35/2	8630740000	T.44	ZDV 1.5N/9 RD	1985790000	T.34	ZDV 2.5N/50 RD	2109000000	T.34	ZDV 4N/50	1528130000	T.72
ZEW 35/2	8630740000	T.44	ZDV 2.5N/10	1527690000	T.7	ZDV 2.5N/6	1527630000	T.34	ZDV 4N/50	1528130000	T.73
ZEW 35/2	8630740000	T.48	ZDV 2.5N/10	1527690000	T.7	ZDV 2.5N/6 BL	1527820000	T.34	ZDV 4N/50	1528130000	T.80
ZEW 35/2	8630740000	T.48	ZDV 2.5N/10	1527690000	T.8	ZDV 2.5N/6 RD	2108720000	T.34	ZDV 4N/50	1528130000	T.81
ZEW 35/2	8630740000	T.49	ZDV 2.5N/10	1527690000	T.11	ZDV 2.5N/7	1527640000	T.34	ZDV 4N/50	1528130000	T.82
ZEW 35/2	8630740000	T.50	ZDV 2.5N/10	1527690000	T.12	ZDV 2.5N/7 BL	1527830000	T.34	ZDV 4N/50	1528130000	T.83
ZEW 35/2	8630740000	T.50	ZDV 2.5N/10	1527690000	T.12	ZDV 2.5N/7 RD	2108810000	T.34	ZDV 4N/50 BL	1528240000	T.34
ZEW 35/2	8630740000	T.51	ZDV 2.5N/10	1527690000	T.13	ZDV 2.5N/8	1527670000	T.34	ZDV 4N/50 BL	1528240000	T.71
ZEW 35/2	8630740000	T.52	ZDV 2.5N/10	1527690000	T.13	ZDV 2.5N/8 BL	1527840000	T.34	ZDV 4N/50 BL	1528240000	T.72
ZEW 35/2	8630740000	T.52	ZDV 2.5N/10	1527690000	T.13	ZDV 2.5N/8 RD	2108870000	T.34	ZDV 4N/50 BL	1528240000	T.73
ZEW 35/2	8630740000	T.53	ZDV 2.5N/10	1527690000	T.14	ZDV 2.5N/9	1527680000	T.34	ZDV 4N/50 BL	1528240000	T.80
ZEW 35/2	8630740000	T.54	ZDV 2.5N/10	1527690000	T.14	ZDV 2.5N/9 BL	1527870000	T.34	ZDV 4N/50 BL	1528240000	T.81
ZEW 35/2	8630740000	T.54	ZDV 2.5N/10	1527690000	T.15	ZDV 2.5N/9 RD	2108900000	T.34	ZDV 4N/50 BL	1528240000	T.82
ZEW 35/2	8630740000	T.55	ZDV 2.5N/10	1527690000	T.22	ZDV 4N/10	1528090000	T.8	ZDV 4N/50 BL	1528240000	T.83
ZEW 35/2	8630740000	T.56	ZDV 2.5N/10	1527690000	T.23	ZDV 4N/10	1528090000	T.9	ZDV 4N/50 RD	2460730000	T.71
ZEW 35/2	8630740000	T.56	ZDV 2.5N/10	1527690000	T.23	ZDV 4N/10	1528090000	T.9	ZDV 4N/50 RD	2460730000	T.72
ZEW 35/2	8630740000	T.57	ZDV 2.5N/10	1527690000	T.24	ZDV 4N/10	1528090000	T.22	ZDV 4N/50 RD	2460730000	T.73
ZEW 35/2	8630740000	T.58	ZDV 2.5N/10	1527690000	T.25	ZDV 4N/10	1528090000	T.26	ZDV 4N/50 RD	2460730000	T.80
ZEW 35/2	8630740000	T.58	ZDV 2.5N/10	1527690000	T.25	ZDV 4N/10	1528090000	T.34	ZDV 4N/50 RD	2460730000	T.81
ZEW 35/2	8630740000	T.60	ZDV 2.5N/10	1527690000	T.25	ZDV 4N/10	1528090000	T.83	ZDV 4N/50 RD	2460730000	T.82
ZEW 35/2	8630740000	T.60	ZDV 2.5N/10	1527690000	T.26	ZDV 4N/10 BL	1528230000	T.34	ZDV 4N/50 RD	2460730000	T.83
ZDV 1.5N/10	1985580000	T.6	ZDV 2.5N/10	1527690000	T.27	ZDV 4N/10 BL	1528230000	T.56	ZDV 4N/50 RD	2460730000	T.84
ZDV 1.5N/10	1985580000	T.6	ZDV 2.5N/10	1527690000	T.28	ZDV 4N/10 BL	1528230000	T.56	ZDV 4N/6	1527990000	T.83
ZDV 1.5N/10	1985580000	T.7	ZDV 2.5N/10	1527690000	T.29	ZDV 4N/10 BL	1528230000	T.57	ZDV 4N/6 BL	1528170000	T.34
ZDV 1.5N/10	1985580000	T.11	ZDV 2.5N/10	1527690000	T.29	ZDV 4N/10 BL	1528230000	T.58	ZDV 4N/6 BL	1528170000	T.83
ZDV 1.5N/10	1985580000	T.34	ZDV 2.5N/10	1527690000	T.30	ZDV 4N/10 BL	1528230000	T.60	ZDV 4N/6 RD	2460780000	T.34
ZDV 1.5N/10 BL	1985680000	T.34	ZDV 2.5N/10	1527690000	T.30	ZDV 4N/10 BL	1528230000	T.60	ZDV 4N/6 RD	2460780000	T.83
ZDV 1.5N/10 BL	1985680000	T.46	ZDV 2.5N/10	1527690000	T.31	ZDV 4N/10 BL	1528230000	T.61	ZDV 4N/7	1528020000	T.34
ZDV 1.5N/10 BL	1985680000	T.46	ZDV 2.5N/10	1527690000	T.34	ZDV 4N/10 BL	1528230000	T.83	ZDV 4N/7	1528020000	T.83
ZDV 1.5N/10 BL	1985680000	T.47	ZDV 2.5N/10	1527690000	T.44	ZDV 4N/10 RD	2460740000	T.34	ZDV 4N/7 BL	1528180000	T.34
ZDV 1.5N/10 BL	1985680000	T.47	ZDV 2.5N/10 BL	1527880000	T.34	ZDV 4N/10 RD	2460740000	T.56	ZDV 4N/7 BL	1528180000	T.83
ZDV 1.5N/10 BL	1985680000	T.47	ZDV 2.5N/10 BL	1527880000	T.52	ZDV 4N/10 RD	2460740000	T.57	ZDV 4N/7 RD	2460770000	T.34
ZDV 1.5N/10 BL	1985680000	T.48	ZDV 2.5N/10 BL	1527880000	T.52	ZDV 4N/10 RD	2460740000	T.58	ZDV 4N/7 RD	2460770000	T.83
ZDV 1.5N/10 BL	1985680000	T.48	ZDV 2.5N/10 BL	1527880000	T.53	ZDV 4N/10 RD	2460740000	T.60	ZDV 4N/8	1528030000	T.34
ZDV 1.5N/10 BL	1985680000	T.49	ZDV 2.5N/10 BL	1527880000	T.54	ZDV 4N/10 RD	2460740000	T.60	ZDV 4N/8	1528030000	T.83
ZDV 1.5N/10 BL	1985680000	T.50	ZDV 2.5N/10 BL	1527880000	T.54	ZDV 4N/10 RD	2460740000	T.61	ZDV 4N/8 BL	1528190000	T.34
ZDV 1.5N/10 BL	1985680000	T.50	ZDV 2.5N/10 BL	1527880000	T.55	ZDV 4N/10 RD	2460740000	T.83	ZDV 4N/8 BL	1528190000	T.83
ZDV 1.5N/10 BL	1985680000	T.51	ZDV 2.5N/10 RD	2108910000	T.34	ZDV 4N/2	1527930000	T.8	ZDV 4N/8 RD	2460760000	T.34
ZDV 1.5N/10 RD	1985800000	T.34	ZDV 2.5N/10 RD	2108910000	T.52	ZDV 4N/2	1527930000	T.9	ZDV 4N/8 RD	2460760000	T.83
ZDV 1.5N/10 RD	1985800000	T.46	ZDV 2.5N/10 RD	2108910000	T.53	ZDV 4N/2	1527930000	T.9	ZDV 4N/9	1528070000	T.34
ZDV 1.5N/10 RD	1985800000	T.47	ZDV 2.5N/10 RD	2108910000	T.54	ZDV 4N/2	1527930000	T.22	ZDV 4N/9	1528070000	T.83
ZDV 1.5N/10 RD	1985800000	T.47	ZDV 2.5N/10 RD	2108910000	T.54	ZDV 4N/2	1527930000	T.26	ZDV 4N/9 BL	1528220000	T.34
ZDV 1.5N/10 RD	1985800000	T.48	ZDV 2.5N/10 RD	2108910000	T.55	ZDV 4N/2	1527930000	T.34	ZDV 4N/9 BL	1528220000	T.83
ZDV 1.5N/10 RD	1985800000	T.49	ZDV 2.5N/2	1527540000	T.7	ZDV 4N/2	1527930000	T.71	ZDV 4N/9 RD	2460750000	T.34
ZDV 1.5N/10 RD	1985800000	T.50	ZDV 2.5N/2	1527540000	T.7	ZDV 4N/2	1527930000	T.72	ZDV 4N/9 RD	2460750000	T.83
ZDV 1.5N/10 RD	1985800000	T.50	ZDV 2.5N/2	1527540000	T.8	ZDV 4N/2	1527930000	T.73	ZDV 6N/2	1985740000	T.10
ZDV 1.5N/10 RD	1985800000	T.51	ZDV 2.5N/2	1527540000	T.11	ZDV 4N/2	1527930000	T.80	ZDV 6N/2	1985740000	T.10
ZDV 1.5N/2	1985410000	T.6	ZDV 2.5N/2	1527540000	T.12	ZDV 4N/2	1527930000	T.81	ZDV 6N/2 BL	1985740000	T.35
ZDV 1.5N/2	1985410000	T.6	ZDV 2.5N/2	1527540000	T.12	ZDV 4N/2	1527930000	T.82	ZDV 6N/2 BL	1985830000	T.35
ZDV 1.5N/2	1985410000	T.7	ZDV 2.5N/2	1527540000	T.13	ZDV 4N/2	1527930000	T.83	ZDV 6N/3	1985760000	T.35
ZDV 1.5N/2	1985410000	T.11	ZDV 2.5N/2	1527540000	T.13	ZDV 4N/2 BL	1528040000	T.34	ZDV 6N/3 BL	1985840000	T.35
ZDV 1.5N/2	1985410000	T.34	ZDV 2.5N/2	1527540000	T.13	ZDV 4N/2 BL	1528040000	T.56	ZDV 6N/4	1985780000	T.35
ZDV 1.5N/2 BL	1985530000	T.34	ZDV 2.5N/2	1527540000	T.14	ZDV 4N/2 BL	1528040000	T.56	ZDV 6N/4 BL	1985850000	T.35
ZDV 1.5N/2 BL	1985530000	T.46	ZDV 2.5N/2	1527540000	T.14	ZDV 4N/2 BL	1528040000	T.57	ZVQ 2.5/1.5	1720700000	T.15
ZDV 1.5N/2 BL	1985530000	T.46	ZDV 2.5N/2	1527540000	T.15	ZDV 4N/2 BL	1528040000	T.58	ZVQ 2.5/1.5	1720700000	T.15
ZDV 1.5N/2 BL	1985530000	T.47	ZDV 2.5N/2	1527540000	T.22	ZDV 4N/2 BL	1528040000	T.60	ZVQ 2.5/1.5	1720700000	T.44
ZDV 1.5N/2 BL	1985530000	T.47	ZDV 2.5N/2	1527540000	T.23	ZDV 4N/2 BL	1528040000	T.60	ZVQ 2.5/1.5	1720700000	T.44
ZDV 1.5N/2 BL	1985530000	T.47	ZDV 2.5N/2	1527540000	T.23	ZDV 4N/2 BL	1528040000	T.61			
ZDV 1.5N/2 BL	1985530000	T.48	ZDV 2.5N/2	15							



Order No.	Type	Page
-----------	------	------

## 031000000

0310000000	PS 2.0 MC	T.6
0310000000	PS 2.0 MC	T.6
0310000000	PS 2.0 MC	T.7
0310000000	PS 2.0 MC	T.7
0310000000	PS 2.0 MC	T.7
0310000000	PS 2.0 MC	T.8
0310000000	PS 2.0 MC	T.8
0310000000	PS 2.0 MC	T.9
0310000000	PS 2.0 MC	T.9
0310000000	PS 2.0 MC	T.10
0310000000	PS 2.0 MC	T.10
0310000000	PS 2.0 MC	T.11
0310000000	PS 2.0 MC	T.12
0310000000	PS 2.0 MC	T.12
0310000000	PS 2.0 MC	T.13
0310000000	PS 2.0 MC	T.13
0310000000	PS 2.0 MC	T.14
0310000000	PS 2.0 MC	T.14
0310000000	PS 2.0 MC	T.15
0310000000	PS 2.0 MC	T.15
0310000000	PS 2.0 MC	T.16
0310000000	PS 2.0 MC	T.16
0310000000	PS 2.0 MC	T.17
0310000000	PS 2.0 MC	T.17
0310000000	PS 2.0 MC	T.17
0310000000	PS 2.0 MC	T.17
0310000000	PS 2.0 MC	T.18
0310000000	PS 2.0 MC	T.18
0310000000	PS 2.0 MC	T.19
0310000000	PS 2.0 MC	T.19
0310000000	PS 2.0 MC	T.20
0310000000	PS 2.0 MC	T.20
0310000000	PS 2.0 MC	T.21
0310000000	PS 2.0 MC	T.21
0310000000	PS 2.0 MC	T.21
0310000000	PS 2.0 MC	T.21
0310000000	PS 2.0 MC	T.22
0310000000	PS 2.0 MC	T.22
0310000000	PS 2.0 MC	T.22
0310000000	PS 2.0 MC	T.23
0310000000	PS 2.0 MC	T.23
0310000000	PS 2.0 MC	T.23
0310000000	PS 2.0 MC	T.24
0310000000	PS 2.0 MC	T.24
0310000000	PS 2.0 MC	T.25
0310000000	PS 2.0 MC	T.25
0310000000	PS 2.0 MC	T.26
0310000000	PS 2.0 MC	T.26
0310000000	PS 2.0 MC	T.27
0310000000	PS 2.0 MC	T.27
0310000000	PS 2.0 MC	T.29
0310000000	PS 2.0 MC	T.30
0310000000	PS 2.0 MC	T.30
0310000000	PS 2.0 MC	T.31
0310000000	PS 2.0 MC	T.44
0310000000	PS 2.0 MC	T.44
0310000000	PS 2.0 MC	T.46
0310000000	PS 2.0 MC	T.46
0310000000	PS 2.0 MC	T.47
0310000000	PS 2.0 MC	T.47
0310000000	PS 2.0 MC	T.47
0310000000	PS 2.0 MC	T.48
0310000000	PS 2.0 MC	T.48
0310000000	PS 2.0 MC	T.50
0310000000	PS 2.0 MC	T.50
0310000000	PS 2.0 MC	T.52
0310000000	PS 2.0 MC	T.52
0310000000	PS 2.0 MC	T.54
0310000000	PS 2.0 MC	T.54
0310000000	PS 2.0 MC	T.56
0310000000	PS 2.0 MC	T.56
0310000000	PS 2.0 MC	T.57
0310000000	PS 2.0 MC	T.58
0310000000	PS 2.0 MC	T.60
0310000000	PS 2.0 MC	T.60
0310000000	PS 2.0 MC	T.178
0310000000	PS 2.0 MC	T.180
0310000000	PS 2.0 MC	T.181
0310000000	PS 2.0 MC	T.182
0310000000	PS 2.0 MC	T.183
0310000000	PS 2.0 MC	T.184
0310000000	PS 2.0 MC	T.186
0310000000	PS 2.0 MC	T.187

## 043000000

0430500000	G 20/0.25A/F	T.58
0430500000	G 20/0.25A/F	T.61
0430600000	G 20/0.50A/F	T.58
0430600000	G 20/0.50A/F	T.61
0430700000	G 20/1.00A/F	T.58
0430700000	G 20/1.00A/F	T.61
0430900000	G 20/2.00A/F	T.58
0430900000	G 20/2.00A/F	T.61
0430900000	G 20/2.00A/F	T.126

## 100000000

1002910000	HDC C HX SM1.5AG	T.131
1002910000	HDC C HX SM1.5AG	T.132

Order No.	Type	Page
-----------	------	------

1002920000	HDC C HX SM2.5AG	T.131
1002920000	HDC C HX SM2.5AG	T.132
1002930000	HDC C HX SM4.0AG	T.131
1002930000	HDC C HX SM4.0AG	T.132
1002940000	HDC C HX SM6.0AG	T.131
1002940000	HDC C HX SM6.0AG	T.132
1002950000	HDC C HX BM1.5AG	T.131
1002950000	HDC C HX BM1.5AG	T.132
1002960000	HDC C HX BM2.5AG	T.131
1002960000	HDC C HX BM2.5AG	T.132
1002970000	HDC C HX BM4.0AG	T.131
1002970000	HDC C HX BM4.0AG	T.132
1002980000	HDC C HX BM6.0AG	T.131
1002980000	HDC C HX BM6.0AG	T.132
1002990000	Removal Tool HX	T.131
1002990000	Removal Tool HX	T.132

## 101000000

1011320000	DEK 5/6 PLUS MC NE WS	T.8
1011320000	DEK 5/6 PLUS MC NE WS	T.9
1011320000	DEK 5/6 PLUS MC NE WS	T.9
1011320000	DEK 5/6 PLUS MC NE WS	T.19
1011320000	DEK 5/6 PLUS MC NE WS	T.19
1011320000	DEK 5/6 PLUS MC NE WS	T.20
1011320000	DEK 5/6 PLUS MC NE WS	T.22
1011320000	DEK 5/6 PLUS MC NE WS	T.26
1011320000	DEK 5/6 PLUS MC NE WS	T.57
1011320000	DEK 5/6 PLUS MC NE WS	T.58
1011320000	DEK 5/6 PLUS MC NE WS	T.58
1011320000	DEK 5/6 PLUS MC NE WS	T.61
1019570000	IE-BHUSB-A	T.153
1019570000	IE-BHUSB-A	T.154
1019570000	IE-BHUSB-A	T.156
1019570000	IE-BHUSB-A	T.156
1019570000	IE-BHUSB-A	T.157
1019570000	IE-BHUSB-A	T.158
1019570000	IE-BHUSB-A	T.158
1019570000	IE-BHUSB-A	T.159
1019570000	IE-BHUSB-A	T.159
1019570000	IE-BHUSB-A	T.161

## 104000000

1046350000	DEK 5/8 PLUS MC NE WS	T.10
1046350000	DEK 5/8 PLUS MC NE WS	T.10
1046350000	DEK 5/8 PLUS MC NE WS	T.20
1046350000	DEK 5/8 PLUS MC NE WS	T.21
1046350000	DEK 5/8 PLUS MC NE WS	T.48
1046350000	DEK 5/8 PLUS MC NE WS	T.48
1046350000	DEK 5/8 PLUS MC NE WS	T.50
1046350000	DEK 5/8 PLUS MC NE WS	T.50

## 106000000

1061210000	WEW 35/2 SW	T.83
1068930000	IE-BP-VAPP	T.175

## 107000000

1073340000	SM 27/18 K MC NE GR	T.152
------------	---------------------	-------

## 111000000

1116530000	HDC-C-HE-BM4.65AU	T.133
1116530000	HDC-C-HE-BM4.65AU	T.134
1116530000	HDC-C-HE-BM4.65AU	T.135
1116530000	HDC-C-HE-BM4.65AU	T.136
1116540000	HDC-C-HE-SM4.65AU	T.133
1116540000	HDC-C-HE-SM4.65AU	T.134
1116540000	HDC-C-HE-SM4.65AU	T.135
1116540000	HDC-C-HE-SM4.65AU	T.136
1118040000	PWZ RJ45	T.160

## 113000000

1131380000	IE-BHUSB-AB	T.153
1131380000	IE-BHUSB-AB	T.154
1131380000	IE-BHUSB-AB	T.156
1131380000	IE-BHUSB-AB	T.156
1131380000	IE-BHUSB-AB	T.157
1131380000	IE-BHUSB-AB	T.158
1131380000	IE-BHUSB-AB	T.158
1131380000	IE-BHUSB-AB	T.159
1131380000	IE-BHUSB-AB	T.159
1131380000	IE-BHUSB-AB	T.161

## 115000000

1157820000	KT 14	T.83
------------	-------	------

## 119000000

1190490000	multi-stripax PV	T.115
------------	------------------	-------

## 120000000

1200500000	HDC-C-HE-SM0.5AG	T.133
1200500000	HDC-C-HE-SM0.5AG	T.134

Order No.	Type	Page
-----------	------	------

1200500000	HDC-C-HE-SM0.5AG	T.135
1200500000	HDC-C-HE-SM0.5AG	T.136
1200600000	HDC-C-HE-SM0.75-1.00AG	T.133
1200600000	HDC-C-HE-SM0.75-1.00AG	T.134
1200600000	HDC-C-HE-SM0.75-1.00AG	T.135
1200600000	HDC-C-HE-SM0.75-1.00AG	T.136
1200700000	HDC-C-HE-SM1.5AG	T.133
1200700000	HDC-C-HE-SM1.5AG	T.134
1200700000	HDC-C-HE-SM1.5AG	T.135
1200700000	HDC-C-HE-SM1.5AG	T.136
1200800000	HDC-C-HE-SM2.5AG	T.133
1200800000	HDC-C-HE-SM2.5AG	T.134
1200800000	HDC-C-HE-SM2.5AG	T.135
1200800000	HDC-C-HE-SM2.5AG	T.136
1200900000	HDC-C-HE-SM4.0AG	T.133
1200900000	HDC-C-HE-SM4.0AG	T.134
1200900000	HDC-C-HE-SM4.0AG	T.135
1200900000	HDC-C-HE-SM4.0AG	T.136
1201100000	HDC-C-HE-BM0.5AG	T.133
1201100000	HDC-C-HE-BM0.5AG	T.134
1201100000	HDC-C-HE-BM0.5AG	T.135
1201100000	HDC-C-HE-BM0.5AG	T.136
1201200000	HDC-C-HE-BM2.5AG	T.133
1201200000	HDC-C-HE-BM2.5AG	T.134
1201200000	HDC-C-HE-BM2.5AG	T.135
1201200000	HDC-C-HE-BM2.5AG	T.136
1201300000	HDC-C-HE-BM1.5AG	T.133
1201300000	HDC-C-HE-BM1.5AG	T.134
1201300000	HDC-C-HE-BM1.5AG	T.135
1201300000	HDC-C-HE-BM1.5AG	T.136
1201400000	HDC-C-HE-BM2.5AG	T.133
1201400000	HDC-C-HE-BM2.5AG	T.134
1201400000	HDC-C-HE-BM2.5AG	T.135
1201400000	HDC-C-HE-BM2.5AG	T.136
1201500000	HDC-C-HE-BM4.0AG	T.133
1201500000	HDC-C-HE-BM4.0AG	T.134
1201500000	HDC-C-HE-BM4.0AG	T.135
1201500000	HDC-C-HE-BM4.0AG	T.136
1203780000	PVC-TV1-BX-4-1000	T.115
1208970000	WS 7.8/9.2 PLUS MC NE GR	T.11
1208970000	WS 7.8/9.2 PLUS MC NE GR	T.52
1208970000	WS 7.8/9.2 PLUS MC NE GR	T.52
1208970000	WS 7.8/9.2 PLUS MC NE GR	T.54
1208970000	WS 7.8/9.2 PLUS MC NE GR	T.54
1208970000	WS 7.8/9.2 PLUS MC NE GR	T.56
1208970000	WS 7.8/9.2 PLUS MC NE GR	T.56
1208970000	WS 7.8/9.2 PLUS MC NE GR	T.60
1208970000	WS 7.8/9.2 PLUS MC NE GR	T.60

## 122000000

1222870000	CTF PV WM4	T.115
------------	------------	-------

## 125000000

1254670000	SCREWTY SW18	T.115
1254870000	VSSO WM4 C	T.115

## 129000000

1290830000	SCREWTY SW15	T.115
------------	--------------	-------

## 130000000

1303760000	SCS 24VDC P1SIL3DS M	T.126
1303890000	SCS 24VDC P1SIL3DS	T.126

## 131000000

1315170000	UR20-4DI-P	T.86
1315180000	UR20-8DI-P-2W	T.86
1315200000	UR20-16DI-P	T.86
1315210000	UR20-16DI-P-PLC-INT	T.86
1315220000	UR20-4DO-P	T.86
1315230000	UR20-4DO-P-2A	T.86
1315240000	UR20-8DO-P	T.86
1315250000	UR20-16DO-P	T.86
1315270000	UR20-16DO-P-PLC-INT	T.86
1315350000	UR20-4DI-N	T.86
1315370000	UR20-8DI-N-3W	T.86
1315390000	UR20-16DI-N	T.86
1315400000	UR20-16DI-N-PLC-INT	T.86
1315410000	UR20-4DO-N	T.86
1315420000	UR20-4DO-N-2A	T.86
1315430000	UR20-8DO-N	T.86
1315440000	UR20-16DO-N	T.86
1315450000	UR20-16DO-N-PLC-INT	T.86
1315540000	UR20-4RO-SSR-255	T.86
1315550000	UR20-4RO-CO-255	T.86
1315570000	UR20-1CNT-100-1DO	T.86
1315580000	UR20-1CNT-500	T.86
1315590000	UR20-2CNT-100	T.86
1315600000	UR20-2PWM-PN-0.5A	T.86
1315610000	UR20-2PWM-PN-2A	T.86
1315620000	UR20-4AI-U1-16	T.86
1315670000	UR20-8AI-PLC-INT	T.86
1315690000	UR20-4AI-U1-16-DIAG	T.86
1315700000	UR20-4AI-RTD-DIAG	T.86



Table with 3 columns: Order No., Type, Page. Contains a list of product codes and their corresponding page numbers.

Table with 3 columns: Order No., Type, Page. Contains a list of product codes and their corresponding page numbers.

153000000

Table with 3 columns: Order No., Type, Page. Contains a list of product codes and their corresponding page numbers.

154000000

Table with 3 columns: Order No., Type, Page. Contains a list of product codes and their corresponding page numbers.

155000000

Table with 3 columns: Order No., Type, Page. Contains a list of product codes and their corresponding page numbers.

Table with 3 columns: Order No., Type, Page. Contains a list of product codes and their corresponding page numbers.

Table with 3 columns: Order No., Type, Page. Contains a list of product codes and their corresponding page numbers.

170000000

Table with 3 columns: Order No., Type, Page. Contains a list of product codes and their corresponding page numbers.

171000000

Table with 3 columns: Order No., Type, Page. Contains a list of product codes and their corresponding page numbers.

172000000

Table with 3 columns: Order No., Type, Page. Contains a list of product codes and their corresponding page numbers.

173000000

Table with 3 columns: Order No., Type, Page. Contains a list of product codes and their corresponding page numbers.

179000000

Table with 3 columns: Order No., Type, Page. Contains a list of product codes and their corresponding page numbers.

180000000

Table with 3 columns: Order No., Type, Page. Contains a list of product codes and their corresponding page numbers.

185000000

Table with 3 columns: Order No., Type, Page. Contains a list of product codes and their corresponding page numbers.

Table with 3 columns: Order No., Type, Page. Rows include 1854490000 DEK 5/5 PLUS MC NE WS T.29, 1854490000 DEK 5/5 PLUS MC NE WS T.30, etc.

1860000000

Table with 3 columns: Order No., Type, Page. Rows include 1866730000 REMOVAL TOOL HD T.137, 1866730000 REMOVAL TOOL HD T.138, etc.

1900000000

Table with 3 columns: Order No., Type, Page. Rows include 1905950000 WS 10/8 PLUS MC NE WS T.10, 1905950000 WS 10/8 PLUS MC NE WS T.10, etc.

1960000000

Table with 3 columns: Order No., Type, Page. Rows include 1962840000 IE-BI-RJ45-C T.153, 1962840000 IE-BI-RJ45-C T.154, etc.

1980000000

Table with 3 columns: Order No., Type, Page. Rows include 1985410000 ZQV 1.5N/2 T.6, 1985410000 ZQV 1.5N/2 T.6, etc.

Table with 3 columns: Order No., Type, Page. Rows include 1985560000 ZQV 1.5N/9 T.34, 1985570000 ZQV 1.5N/4 BL T.34, etc.

Table with 3 columns: Order No., Type, Page. Rows include 1985560000 ZQV 1.5N/9 T.34, 1985570000 ZQV 1.5N/4 BL T.34, etc.

Table with 3 columns: Order No., Type, Page. Rows include 1989840000 ADT 2.5 3C BL T.25, 1989860000 ADT 2.5 4C T.25, etc.

Table with 3 columns: Order No., Type, Page. Rows include 1989840000 ADT 2.5 3C BL T.25, 1989860000 ADT 2.5 4C T.25, etc.

Table with 3 columns: Order No., Type, Page. Rows include 1991890000 ATPG 1.5-10 L T.52, 1991890000 ATPG 1.5-10 L T.52, etc.

Table with 3 columns: Order No., Type, Page. Rows include 1991890000 ATPG 1.5-10 L T.52, 1991890000 ATPG 1.5-10 L T.52, etc.

1990000000

Table with 3 columns: Order No., Type, Page. Rows include 1990070000 UR20-2AI-SG-24-DIAG T.86, 1990070000 UR20-2AI-SG-24-DIAG T.88, etc.







Order No.	Type	Page
2050640150	SAIL-M12G-T-1.5P	T.150
2050640300	SAIL-M12G-T-3.0P	T.150
2050640500	SAIL-M12G-T-5.0P	T.150
2050641000	SAIL-M12G-T-10P	T.150
2050650150	SAIL-M12W-T-1.5P	T.150
2050650300	SAIL-M12W-T-3.0P	T.150
2050650500	SAIL-M12W-T-5.0P	T.150
2050651000	SAIL-M12W-T-10P	T.150
2050680150	SAIL-M12BG-T-1.5H	T.150
2050680300	SAIL-M12BG-T-3.0H	T.150
2050680500	SAIL-M12BG-T-5.0H	T.150
2050681000	SAIL-M12BG-T-10H	T.150
2050690150	SAIL-M12BW-T-1.5H	T.150
2050690300	SAIL-M12BW-T-3.0H	T.150
2050690500	SAIL-M12BW-T-5.0H	T.150
2050691000	SAIL-M12BW-T-10H	T.150
2050700150	SAIL-M12G-T-1.5H	T.150
2050700300	SAIL-M12G-T-3.0H	T.150
2050700500	SAIL-M12G-T-5.0H	T.150
2050701000	SAIL-M12G-T-10H	T.150
2050710150	SAIL-M12W-T-1.5H	T.150
2050710300	SAIL-M12W-T-3.0H	T.150
2050710500	SAIL-M12W-T-5.0H	T.150
2050711000	SAIL-M12W-T-10H	T.150
2050760150	SAIL-M12GM12G-T-1.5P	T.151
2050760300	SAIL-M12GM12G-T-3.0P	T.151
2050760500	SAIL-M12GM12G-T-5.0P	T.151
2050761000	SAIL-M12GM12G-T-10P	T.151
2050820150	SAIL-M12WM12G-T-1.5P	T.151
2050820300	SAIL-M12WM12G-T-3.0P	T.151
2050820500	SAIL-M12WM12G-T-5.0P	T.151
2050821000	SAIL-M12WM12G-T-10P	T.151
2050830150	SAIL-M12GM12W-T-1.5P	T.151
2050830300	SAIL-M12GM12W-T-3.0P	T.151
2050830500	SAIL-M12GM12W-T-5.0P	T.151
2050831000	SAIL-M12GM12W-T-10P	T.151
2050860150	SAIL-M12WM12W-T-1.5P	T.151
2050860300	SAIL-M12WM12W-T-3.0P	T.151
2050860500	SAIL-M12WM12W-T-5.0P	T.151
2050861000	SAIL-M12WM12W-T-10P	T.151
2050870150	SAIL-M12GM12G-T-1.5H	T.151
2050870300	SAIL-M12GM12G-T-3.0H	T.151
2050870500	SAIL-M12GM12G-T-5.0H	T.151
2050871000	SAIL-M12GM12G-T-10H	T.151
2050890150	SAIL-M12WM12G-T-1.5H	T.151
2050890300	SAIL-M12WM12G-T-3.0H	T.151
2050890500	SAIL-M12WM12G-T-5.0H	T.151
2050891000	SAIL-M12WM12G-T-10H	T.151
2050910150	SAIL-M12GM12W-T-1.5H	T.151
2050910300	SAIL-M12GM12W-T-3.0H	T.151
2050910500	SAIL-M12GM12W-T-5.0H	T.151
2050911000	SAIL-M12GM12W-T-10H	T.151
2050920150	SAIL-M12WM12W-T-1.5H	T.151
2050920300	SAIL-M12WM12W-T-3.0H	T.151
2050920500	SAIL-M12WM12W-T-5.0H	T.151
2050921000	SAIL-M12WM12W-T-10H	T.151
2051180000	A2C 4	T.8
2051210000	A2C 4 BL	T.8
2051240000	A3C 4	T.9
2051280000	A3C 4 BL	T.9
2051360000	A2C 4 PE	T.19
2051410000	A3C 4 PE	T.19
2051500000	A4C 4	T.9
2051520000	A4C 4 BL	T.9
2051560000	A4C 4 PE	T.20
2051680000	AEP 2C 4	T.8
2051680000	AEP 2C 4	T.19
2051690000	AEP 2C 4 BL	T.8
2051720000	AEP 3C 4	T.9
2051720000	AEP 3C 4	T.19
2051880000	AEP 3C 4 BL	T.9
2051900000	AEP 4C 4	T.9
2051900000	AEP 4C 4	T.20
2051900000	AEP 4C 4	T.26
2051910000	AEP 4C 4 BL	T.9
2051910000	AEP 4C 4 BL	T.26

## 2060000000

2065120000	ALO 6 BL	T.11
2067070000	IE-FC-DIP-PWB/2ST/FILS	T.153
2067080000	IE-FC-DSP-PWB/2ST/FILS	T.153
2068620000	UR20-PK-1990070000-SP	T.88

## 2080000000

2080360000	AMG ELM-6	T.67
2080410000	AMG ELM-12	T.68
2080420000	AMG ELM-1F	T.64
2080480000	AMG ELM-2F	T.64
2080490000	AMG ELM-4F	T.64
2080500000	AMG ELM-6F	T.64
2080600000	AMG ELM-8F	T.65
2080650000	AMG ELM-10F	T.65
2080750000	AMG ELM-Q2222	T.70
2080800000	AMG ELM-Q4444	T.70
2080920000	AMG ELM-06666	T.70
2081650000	AMG ELM-Q2244	T.70
2081820000	AMG ELM-Q2266	T.70

2081870000	AMG FIM-0	T.62
2081880000	AMG FIM-C	T.63
2081890000	AMG AM	T.71
2081900000	AMG CM	T.72
2082000000	AMG ELM-6 EX	T.78
2082010000	AMG ELM-12 EX	T.79
2082040000	AMG ELM-1F EX	T.76
2082050000	AMG ELM-2F EX	T.76
2082060000	AMG ELM-4F EX	T.76
2082310000	AMG ELM-6F EX	T.76
2082320000	AMG ELM-8F EX	T.77
2082430000	AMG ELM-10F EX	T.77
2082440000	AMG ELM-6D CO	T.69
2082470000	AMG ELM-10D CO	T.69
2082530000	AMG FIM-0 EX	T.74
2082540000	AMG FIM-C EX	T.75
2082770000	AMG AM CO	T.80
2083360000	AMG CM EX	T.81

## 2100000000

2108470000	ZQV 2.5N/2 RD	T.34
2108470000	ZQV 2.5N/2 RD	T.52
2108470000	ZQV 2.5N/2 RD	T.53
2108470000	ZQV 2.5N/2 RD	T.54
2108470000	ZQV 2.5N/2 RD	T.54
2108470000	ZQV 2.5N/2 RD	T.55
2108690000	ZQV 2.5N/3 RD	T.34
2108700000	ZQV 2.5N/4 RD	T.34
2108710000	ZQV 2.5N/5 RD	T.34
2108720000	ZQV 2.5N/6 RD	T.34
2108810000	ZQV 2.5N/7 RD	T.34
2108870000	ZQV 2.5N/8 RD	T.34
2108900000	ZQV 2.5N/9 RD	T.34
2108910000	ZQV 2.5N/10 RD	T.34
2108910000	ZQV 2.5N/10 RD	T.52
2108910000	ZQV 2.5N/10 RD	T.53
2108910000	ZQV 2.5N/10 RD	T.54
2108910000	ZQV 2.5N/10 RD	T.55
2108920000	ZQV 2.5N/20 RD	T.34
2109000000	ZQV 2.5N/50 RD	T.34

## 2120000000

2122910000	AMG OD	T.64
2122910000	AMG OD	T.65
2122910000	AMG OD	T.67
2122910000	AMG OD	T.68
2122910000	AMG OD	T.69
2122910000	AMG OD	T.73
2122910000	AMG OD	T.76
2122910000	AMG OD	T.77
2122910000	AMG OD	T.78
2122910000	AMG OD	T.79
2122920000	AMG PD	T.64
2122920000	AMG PD	T.65
2122920000	AMG PD	T.67
2122920000	AMG PD	T.68
2122920000	AMG PD	T.69
2122920000	AMG PD	T.73
2122920000	AMG PD	T.76
2122920000	AMG PD	T.77
2122920000	AMG PD	T.78
2122920000	AMG PD	T.79
2122930000	AMG MD	T.64
2122930000	AMG MD	T.65
2122930000	AMG MD	T.67
2122930000	AMG MD	T.68
2122930000	AMG MD	T.69
2122930000	AMG MD	T.73
2122930000	AMG MD	T.76
2122930000	AMG MD	T.77
2122930000	AMG MD	T.78
2122930000	AMG MD	T.79
2122940000	AMG XMD	T.70
2122940000	AMG XMD	T.73
2123000000	AMG PP	T.83
2123050000	AMG DIS	T.64
2123050000	AMG DIS	T.65
2123050000	AMG DIS	T.67
2123050000	AMG DIS	T.68
2123050000	AMG DIS	T.69
2123050000	AMG DIS	T.73
2123050000	AMG DIS	T.76
2123050000	AMG DIS	T.77
2123050000	AMG DIS	T.78
2123050000	AMG DIS	T.79

## 2420000000

2425170000	UR20-PK-1334940000-SP	T.87
2426250000	UR67-PN-HP-BIOL-12-30M	T.89
2426260000	UR67-PN-HP-BIOL-12-60M	T.89
2426700000	IE-FCI-PWB-CZ	T.153
2426700000	IE-FCI-PWB-CZ	T.156
2426700000	IE-FCI-PWB-CZ	T.167
2428510000	A3T 2.5	T.13
2428520000	A3T 2.5 BL	T.13

2428530000	A3T 2.5 FT-FT-PE	T.14
2428540000	A3T 2.5 VL	T.13
2428550000	A3T 2.5 PE	T.21
2428560000	AEP 3T 2.5	T.13
2428560000	AEP 3T 2.5	T.13
2428560000	AEP 3T 2.5	T.14
2428560000	AEP 3T 2.5	T.14
2428560000	AEP 3T 2.5	T.21
2428840000	A3T 2.5 N-FT-PE	T.14
2428850000	A3T 2.5 VL BL	T.13
2428860000	AEP 3T 2.5 BL	T.13
2428860000	AEP 3T 2.5 BL	T.13
2428860000	AEP 3T 2.5 BL	T.14
2428860000	AEP 3T 2.5 BL	T.14
2428910000	AAP21 10 LO RD	T.56
2428920000	AAP21 10 FE	T.56
2428930000	AAP21 4 LD RD	T.57
2428940000	AAP21 10 LD BL	T.56
2428950000	AAP21 4 FS	T.58
2428960000	AAP21 4 LI BL	T.57
2428980000	AAP21 4 DT	T.58
2428990000	AAP22 10 LD-LO	T.60
2429000000	AAP22 10 FELO	T.60
2429010000	AAP22 4 LIFS	T.61
2429020000	AEP AP21	T.56
2429020000	AEP AP21	T.56
2429020000	AEP AP21	T.57
2429020000	AEP AP21	T.58
2429020000	AEP AP21	T.60
2429040000	AEP AP22	T.60
2429040000	AEP AP22	T.61
2429850000	ADT 4 2C	T.26
2429860000	AFS 4 2C BK	T.22
2429870000	AFS 4 2C 10-36V BK	T.22
2429880000	ADT 4 2C BL	T.26

## 2430000000

2433820000	AEP MC 2.5	T.15
2433820000	AEP MC 2.5	T.44
2433950000	TRANSLUCIN 16I+ 1K5 L	T.116
2434340000	AMC 2.5	T.15
2434340000	AMC 2.5	T.44
2434350000	AFS 4 2C 30-70V BK	T.22
2434370000	AMC 2.5 800V	T.15
2434370000	AMC 2.5 800V	T.44
2434380000	AFS 4 2C 60-150V BK	T.22
2434390000	AFS 4 2C 100-250V BK	T.22
2436210000	WIL-STANDARD	T.176
2436230000	BKP-16D0-SDV541-V1-S	T.126
2436660000	VT CL	T.195
2436670000	VT LCL	T.195
2436680000	VT M	T.196
2436690000	VT CTL	T.196
2437470000	HS 0.8-2.4/25 MM W	T.198
2437480000	HS 0.8-2.4/25 MM Y	T.198
2437490000	HS 0.8-2.4/50 MM W	T.198
2437500000	HS 0.8-2.4/50 MM Y	T.198
2437510000	HS 1.0-3.2/25 MM W	T.198
2437520000	HS 1.0-3.2/25 MM Y	T.198
2437530000	HS 1.0-3.2/50 MM W	T.198
2437540000	HS 1.0-3.2/50 MM Y	T.198
2437550000	HS 1.6-4.8/25 MM W	T.198
2437560000	HS 1.6-4.8/25 MM Y	T.198
2437570000	HS 1.6-4.8/50 MM W	T.198
2437580000	HS 1.6-4.8/50 MM Y	T.198
2437590000	HS 12.7-38.1/25 MM W	T.198
2437600000	HS 12.7-38.1/25 MM Y	T.198
2437610000	HS 12.7-38.1/50 MM W	T.198
2437620000	HS 12.7-38.1/50 MM Y	T.198
2437630000	HS 2.1-6.4/25 MM W	T.198
2437640000	HS 2.1-6.4/25 MM Y	T.198
2437650000	HS 2.1-6.4/50 MM W	T.198
2437660000	HS 2.1-6.4/50 MM Y	T.198
2437670000	HS 3.2-9.5/25 MM W	T.198
2437680000	HS 3.2-9.5/25 MM Y	T.198
2437690000	HS 3.2-9.5/50 MM W	T.198
2437700000	HS 3.2-9.5/50 MM Y	T.198
2437710000	HS 4.2-12.7/25 MM W	T.198
2437720000	HS 4.2-12.7/25 MM Y	T.198
2437730000	HS 4.2-12.7/50 MM W	T.198
2437740000	HS 4.2-12.7/50 MM Y	T.198
2437750000	HS 6.4-19.1/25 MM W	T.198
2437760000	HS 6.4-19.1/25 MM Y	T.198
2437770000	HS 6.4-19.1/50 MM W	T.198
2437780000	HS 6.4-19.1/50 MM Y	T.198
2437790000	HS 8.5-25.4/25 MM W	T.198
2437800000	HS 8.5-25.4/25 MM Y	T.198
2437810000	HS 8.5-25.4/50 MM W	T.198
2437820000	HS 8.5-25.4/50 MM Y	T.198
2437830000	HSHF 1.2-2.4/25 MM W	T.199
2437840000	HSHF 1.2-2.4/25 MM Y	T.199
2437850000	HSHF 1.2-2.4/50 MM W	T.199
2437860000	HSHF 1.2-2.4/50 MM Y	T.199
2437870000	HSHF 1.6-3.2/25 MM W	T.199
2437880000	HSHF 1.6-3.2/25 MM Y	T.199
2437890000	HSHF 1.6-3.2/50 MM W	T.199
2437900000	HSHF 1.6-3.2/50 MM Y	T.199

2437910000	HSHF 12.7-25.4/25 MM W	T.199
2437920000	HSHF 12.7-25.4/25 MM Y	T.199
2437930000	HSHF 12.7-25.4/50 MM W	T.199
2437940000	HSHF 12.7-25.4/5	

Order No.	Type	Page
2455150500	SAIL-M12BG-K-5.0P	T.146
2455151000	SAIL-M12BG-K-10P	T.146
2455190150	SAIL-M12BW-K-1.5P	T.146
2455190300	SAIL-M12BW-K-3.0P	T.146
2455190500	SAIL-M12BW-K-5.0P	T.146
2455191000	SAIL-M12BW-K-10P	T.146
2455200150	SAIL-M12BWL-1.5P	T.144
2455200300	SAIL-M12BWL-3.0P	T.144
2455200500	SAIL-M12BWL-5.0P	T.144
2455201000	SAIL-M12BWL-10P	T.144
2455210150	SAIL-M12G-K-1.5P	T.146
2455210300	SAIL-M12G-K-3.0P	T.146
2455210500	SAIL-M12G-K-5.0P	T.146
2455211000	SAIL-M12G-K-10P	T.146
2455220150	SAIL-M12G-L-1.5P	T.144
2455220300	SAIL-M12G-L-3.0P	T.144
2455220500	SAIL-M12G-L-5.0P	T.144
2455221000	SAIL-M12G-L-10P	T.144
2455230150	SAIL-M12W-K-1.5P	T.146
2455230300	SAIL-M12W-K-3.0P	T.146
2455230500	SAIL-M12W-K-5.0P	T.146
2455231000	SAIL-M12W-K-10P	T.146
2455240150	SAIL-M12W-L-1.5P	T.144
2455240300	SAIL-M12W-L-3.0P	T.144
2455240500	SAIL-M12W-L-5.0P	T.144
2455241000	SAIL-M12W-L-10P	T.144
2455250150	SAIL-M12GM12G-K-1.5P	T.147
2455250300	SAIL-M12GM12G-K-3.0P	T.147
2455250500	SAIL-M12GM12G-K-5.0P	T.147
2455251000	SAIL-M12GM12G-K-10P	T.147
2455260150	SAIL-M12GM12G-L-1.5P	T.145
2455260300	SAIL-M12GM12G-L-3.0P	T.145
2455260500	SAIL-M12GM12G-L-5.0P	T.145
2455261000	SAIL-M12GM12G-L-10P	T.145
2455270150	SAIL-M12GM12W-K-1.5P	T.147
2455270300	SAIL-M12GM12W-K-3.0P	T.147
2455270500	SAIL-M12GM12W-K-5.0P	T.147
2455271000	SAIL-M12GM12W-K-10P	T.147
2455280150	SAIL-M12GM12W-L-1.5P	T.145
2455280300	SAIL-M12GM12W-L-3.0P	T.145
2455280500	SAIL-M12GM12W-L-5.0P	T.145
2455281000	SAIL-M12GM12W-L-10P	T.145
2455290150	SAIL-M12WM12W-K-1.5P	T.147
2455290300	SAIL-M12WM12W-K-3.0P	T.147
2455290500	SAIL-M12WM12W-K-5.0P	T.147
2455291000	SAIL-M12WM12W-K-10P	T.147
2455300150	SAIL-M12WM12W-L-1.5P	T.145
2455300300	SAIL-M12WM12W-L-3.0P	T.145
2455300500	SAIL-M12WM12W-L-5.0P	T.145
2455301000	SAIL-M12WM12W-L-10P	T.145
2455310150	SAIL-M12WM12G-K-1.5P	T.147
2455310300	SAIL-M12WM12G-K-3.0P	T.147
2455310500	SAIL-M12WM12G-K-5.0P	T.147
2455311000	SAIL-M12WM12G-K-10P	T.147
2455320150	SAIL-M12WM12G-L-1.5P	T.145
2455320300	SAIL-M12WM12G-L-3.0P	T.145
2455320500	SAIL-M12WM12G-L-5.0P	T.145
2455321000	SAIL-M12WM12G-L-10P	T.145
2455330150	SAIL-M12BG-L-1.5P	T.144
2455330300	SAIL-M12BG-L-3.0P	T.144
2455330500	SAIL-M12BG-L-5.0P	T.144
2455331000	SAIL-M12BG-L-10P	T.144
2457570000	APGL 2.5	T.32
2457580000	APGSR 2.5	T.32
2457590000	APGSR 2.5/4	T.32
2457600000	APGSR 2.5/8	T.32
2458990000	AAP21 4 FS 10.36V	T.58
2459010000	AAP22 4 Lifs 10.36V	T.61

## 2460000000

2460120000	AAP22 4 Lifs 100-250V	T.61
2460130000	AAP22 4 Lifs 60-150V	T.61
2460140000	AAP22 4 Lifs 30-70V	T.61
2460180000	AAP21 4 FS 100-250V	T.58
2460190000	AAP21 4 FS 60-150V	T.58
2460200000	AAP21 4 FS 30-70V	T.58
2460450000	Z0V 4N/2 RD	T.34
2460450000	Z0V 4N/2 RD	T.56
2460450000	Z0V 4N/2 RD	T.57
2460450000	Z0V 4N/2 RD	T.58
2460450000	Z0V 4N/2 RD	T.60
2460450000	Z0V 4N/2 RD	T.61
2460450000	Z0V 4N/2 RD	T.71
2460450000	Z0V 4N/2 RD	T.72
2460450000	Z0V 4N/2 RD	T.73
2460450000	Z0V 4N/2 RD	T.80
2460450000	Z0V 4N/2 RD	T.81
2460450000	Z0V 4N/2 RD	T.82
2460450000	Z0V 4N/2 RD	T.83
2460730000	Z0V 4N/50 RD	T.71
2460730000	Z0V 4N/50 RD	T.72
2460730000	Z0V 4N/50 RD	T.73
2460730000	Z0V 4N/50 RD	T.80
2460730000	Z0V 4N/50 RD	T.81
2460730000	Z0V 4N/50 RD	T.82
2460730000	Z0V 4N/50 RD	T.83
2460740000	Z0V 4N/10 RD	T.34

Order No.	Type	Page
2460740000	Z0V 4N/10 RD	T.56
2460740000	Z0V 4N/10 RD	T.57
2460740000	Z0V 4N/10 RD	T.58
2460740000	Z0V 4N/10 RD	T.60
2460740000	Z0V 4N/10 RD	T.60
2460740000	Z0V 4N/10 RD	T.61
2460740000	Z0V 4N/10 RD	T.83
2460750000	Z0V 4N/9 RD	T.34
2460750000	Z0V 4N/9 RD	T.83
2460760000	Z0V 4N/8 RD	T.34
2460760000	Z0V 4N/8 RD	T.83
2460770000	Z0V 4N/7 RD	T.34
2460770000	Z0V 4N/7 RD	T.83
2460780000	Z0V 4N/6 RD	T.34
2460780000	Z0V 4N/6 RD	T.83
2460790000	Z0V 4N/5 RD	T.34
2460790000	Z0V 4N/5 RD	T.83
2460800000	Z0V 4N/4 RD	T.34
2460800000	Z0V 4N/4 RD	T.83
2460810000	Z0V 4N/3 RD	T.34
2460810000	Z0V 4N/3 RD	T.83
2461730000	BKP-16DD-SDV541-V0-S	T.126
2465440000	IE-PS-VAPM-SP-2.5	T.174
2466530000	AFS 2.5 CF 2C BK	T.22
2466600000	AFS 2.5 CF 2C 24V BK	T.22
2466610000	AFS 2.5 CF 2C 12V BK	T.22
2469380000	ES EPG 60 WM 6	T.191
2469540000	ES EPG 60 WM 10	T.191
2469550000	ES EPG 60 WM 16	T.191
2469560000	ES EPG 60 WM 25	T.191
2469570000	ES EPG 60 WM 35	T.191
2469580000	ES EPG 60 WM 50	T.191
2469590000	ES EPG 60 WM 70	T.191
2469600000	ES EPG 60 WM 95	T.191
2469610000	ES EPG 60 WM 120	T.191
2469620000	ES EPG 60 WM 150	T.191
2469630000	ES EPG 60 WM 185	T.191
2469640000	ES EPG 60 WM 240	T.191
2469650000	ES EPG 60 WM 300	T.191

## 2470000000

2471520000	LLF 7.50/01/90 5.0SN BK BX	T.186
2471530000	LLF 7.50/02/90V 5.0SN BK BX	T.187
2471909000	LLF 7.50/03/90V 5.0SN BK BX	T.187
2472100000	LLF 7.50/04/90V 5.0SN BK BX	T.187
2472110000	LLF 7.50/05/90V 5.0SN BK BX	T.187
2472120000	LLF 7.50/06/90V 5.0SN BK BX	T.187
2472130000	LLF 7.50/07/90V 5.0SN BK BX	T.187
2472140000	LLF 7.50/08/90V 5.0SN BK BX	T.187
2472150000	LLF 7.50/09/90V 5.0SN BK BX	T.187
2472160000	LLF 7.50/10/90V 5.0SN BK BX	T.187
2472170000	LLF 7.50/11/90V 5.0SN BK BX	T.187
2472180000	LLF 7.50/12/90V 5.0SN BK BX	T.187
2476450000	UR20-FBC-MOD-TCP-V2	T.85
2476450000	UR20-FBC-MOD-TCP-V2	T.86

## 2480000000

2485280000	UR20-PK-2476450000-SP	T.85
2486640000	AEP 3C 4 BK	T.22
2486660000	AEP 4C 2.5 BK	T.22
2489780000	ENERGY ANALYSER D550-24	T.94

## 2490000000

2491270000	AMG ELM-1F CL2	T.66
2491280000	AMG ELM-2F CL2	T.66
2491290000	AMG ELM-4F CL2	T.66
2491800000	LUF 15.00/02/90 5.0SN BK BX	T.182
2491810000	LUFs 15.00/01/180 5.0SN BK BX	T.180
2491820000	LUFs 15.00/02/180V 5.0SN BK BX	T.184
2491900000	LUF 15.00/03/90 5.0SN BK BX	T.182
2491910000	LUF 15.00/04/90 5.0SN BK BX	T.182
2491920000	LUF 15.00/05/90 5.0SN BK BX	T.182
2491930000	LUF 15.00/06/90 5.0SN BK BX	T.182
2491940000	LUF 15.00/07/90 5.0SN BK BX	T.182
2491950000	LUF 15.00/08/90 5.0SN BK BX	T.182
2492000000	LUF 15.00/02/90V 5.0SN BK BX	T.183
2492010000	LUF 15.00/03/90V 5.0SN BK BX	T.183
2492020000	LUF 15.00/04/90V 5.0SN BK BX	T.183
2492030000	LUF 15.00/05/90V 5.0SN BK BX	T.183
2492040000	LUF 15.00/06/90V 5.0SN BK BX	T.183
2492050000	LUF 15.00/07/90V 5.0SN BK BX	T.183
2492060000	LUF 15.00/08/90V 5.0SN BK BX	T.183
2492110000	LUFs 15.00/02/180V 5.0SN BK BX	T.181
2492120000	LUFs 15.00/03/180V 5.0SN BK BX	T.181
2492130000	LUFs 15.00/04/180V 5.0SN BK BX	T.181
2492140000	LUFs 15.00/05/180V 5.0SN BK BX	T.181
2492150000	LUFs 15.00/06/180V 5.0SN BK BX	T.181
2492160000	LUFs 15.00/07/180V 5.0SN BK BX	T.181
2492170000	LUFs 15.00/08/180V 5.0SN BK BX	T.181
2492180000	LUFs 15.00/09/180V 5.0SN BK BX	T.181
2492190000	LUFs 15.00/10/180V 5.0SN BK BX	T.181
2492200000	LUFs 15.00/11/180V 5.0SN BK BX	T.181
2492210000	LUFs 15.00/12/180V 5.0SN BK BX	T.181
2492220000	LUFs 15.00/03/180V 5.0SN BK BX	T.184
2492230000	LUFs 15.00/04/180V 5.0SN BK BX	T.184
2492240000	LUFs 15.00/05/180V 5.0SN BK BX	T.184

Order No.	Type	Page
2492250000	LUFs 15.00/06/180V 5.0SN BK BX	T.184
2492260000	LUFs 15.00/07/180V 5.0SN BK BX	T.184
2492270000	LUFs 15.00/08/180V 5.0SN BK BX	T.184
2493480000	IE-BSS-VAPM-24V	T.175
2493490000	IE-BHD-VAPM	T.175
2494060000	IE-BPD-VAPM-DC	T.175
2494550000	HDC C MHX SM10.OAG	T.132
2494560000	HDC C MHX BM10.OAG	T.132
2495040000	AMG MD EX	T.82
2495070000	AMG PD EX	T.82
2495080000	AMG XMD EX	T.82
2495090000	AMG OD EX	T.82
2495100000	AMG DIS EX	T.82
2495380000	AMG EP	T.83
2496190000	ITS 24-240VUC 1CO M7C	T.106

## 2500000000

2500710000	IE-FCI-PWB-IND	T.153
2500710000	IE-FCI-PWB-IND	T.156
2500710000	IE-FCI-PWB-IND	T.169
2500760000	AMG EP KIT	T.83
2502530000	WPD 130 1X50/1X50 GY	T.38
2502540000	WPD 130 1X50/1X50 BL	T.38
2502550000	WPD 130 1X50/1X50 GN	T.38
2502560000	WPD 130 1X50/1X50 BN	T.38
2502570000	WPD 130 1X50/1X50 BK	T.38
2502580000	WPD 230 2X50/2X50 GY	T.38
2502590000	WPD 230 2X50/2X50 BL	T.38
2502600000	WPD 230 2X50/2X50 GN	T.38
2502610000	WPD 230 2X50/2X50 BN	T.38
2502620000	WPD 330 3X50/3X50 3XGY	T.39
2502640000	WPD 330 1XGY/1XBL/1XGN	T.39
2502650000	WPD 330 3X50/3X50 1XBN/1XKB/1XGY	T.39
2502660000	WPD 131 1X95/1X95 BL	T.40
2502670000	WPD 131 1X95/1X95 GN	T.40
2502680000	WPD 131 1X95/1X95 BN	T.40
2502690000	WPD 131 1X95/1X95 BK	T.40
2502700000	WPD 231 2X95/2X95 GY	T.40
2502710000	WPD 231 2X95/2X95 BL	T.40
2502720000	WPD 231 2X95/2X95 GN	T.40
2502730000	WPD 231 2X95/2X95 BN	T.40
2502740000	WPD 231 2X95/2X95 BK	T.40
2502750000	WPD 132 1X185/1X185 GY	T.41
2502760000	WPD 132 1X185/1X185 BL	T.41
2502770000	WPD 132 1X185/1X185 GN	T.41
2502780000	WPD 132 1X185/1X185 BN	T.41
2502790000	WPD 132 1X185/1X185 BK	T.41
2502800000	WPD 232 2X185/2X185 GY	T.41
2502810000	WPD 232 2X185/2X185 BL	T.41
2502820000	WPD 232 2X185/2X185 GN	T.41
2502830000	WPD 232 2X185/2X185 BN	T.41
2502840000	WPD 232 2X185/2X185 BK	T.41
2502850000	WPD 133 1X300/1X300 GY	T.42
2502860000	WPD 133 1X300/1X300 BL	T.42
2502870000	WPD 133 1X300/1X300 GN	T.42
2502880000	WPD 133 1X300/1X300 BN	T.42
2502890000	WPD 133 1X300/1X300 BK	T.42
2502900000	WPD 233 2X300/2X300 GY	T.42
2502910000	WPD 233 2X300/2X300 BL	T.42
2502920000	WPD 233 2X300/2X300 GN	T.42
2502930000	WPD 233 2X300/2X300 BN	T.42
2502940000	WPD 233 2X300/2X300 BK	T.42
250295		

Order No.	Type	Page
-----------	------	------

## 901000000

9018020000	MTR 110	T.130
9018490000	CTX CM 1.6/2.5	T.133
9018490000	CTX CM 1.6/2.5	T.134
9018490000	CTX CM 1.6/2.5	T.135
9018490000	CTX CM 1.6/2.5	T.136
9018490000	CTX CM 1.6/2.5	T.137
9018490000	CTX CM 1.6/2.5	T.138

## 903000000

9037160000	SDS 0.4X2.0X60	T.6
9037160000	SDS 0.4X2.0X60	T.6
9037160000	SDS 0.4X2.0X60	T.7
9037160000	SDS 0.4X2.0X60	T.16
9037160000	SDS 0.4X2.0X60	T.16
9037160000	SDS 0.4X2.0X60	T.17
9037160000	SDS 0.4X2.0X60	T.46
9037160000	SDS 0.4X2.0X60	T.46
9037160000	SDS 0.4X2.0X60	T.47
9037160000	SDS 0.4X2.0X60	T.47
9037160000	SDS 0.4X2.0X60	T.47

## 904000000

9042110000	SDIL 0.6x3.5x100	T.7
9042110000	SDIL 0.6x3.5x100	T.7
9042110000	SDIL 0.6x3.5x100	T.8
9042110000	SDIL 0.6x3.5x100	T.8
9042110000	SDIL 0.6x3.5x100	T.9
9042110000	SDIL 0.6x3.5x100	T.9
9042110000	SDIL 0.6x3.5x100	T.12
9042110000	SDIL 0.6x3.5x100	T.12
9042110000	SDIL 0.6x3.5x100	T.13
9042110000	SDIL 0.6x3.5x100	T.13
9042110000	SDIL 0.6x3.5x100	T.13
9042110000	SDIL 0.6x3.5x100	T.14
9042110000	SDIL 0.6x3.5x100	T.14
9042110000	SDIL 0.6x3.5x100	T.15
9042110000	SDIL 0.6x3.5x100	T.15
9042110000	SDIL 0.6x3.5x100	T.17
9042110000	SDIL 0.6x3.5x100	T.17
9042110000	SDIL 0.6x3.5x100	T.18
9042110000	SDIL 0.6x3.5x100	T.19
9042110000	SDIL 0.6x3.5x100	T.19
9042110000	SDIL 0.6x3.5x100	T.20
9042110000	SDIL 0.6x3.5x100	T.21
9042110000	SDIL 0.6x3.5x100	T.21
9042110000	SDIL 0.6x3.5x100	T.22
9042110000	SDIL 0.6x3.5x100	T.22
9042110000	SDIL 0.6x3.5x100	T.23
9042110000	SDIL 0.6x3.5x100	T.23
9042110000	SDIL 0.6x3.5x100	T.24
9042110000	SDIL 0.6x3.5x100	T.24
9042110000	SDIL 0.6x3.5x100	T.25
9042110000	SDIL 0.6x3.5x100	T.25
9042110000	SDIL 0.6x3.5x100	T.26
9042110000	SDIL 0.6x3.5x100	T.26
9042110000	SDIL 0.6x3.5x100	T.26
9042110000	SDIL 0.6x3.5x100	T.27
9042110000	SDIL 0.6x3.5x100	T.27
9042110000	SDIL 0.6x3.5x100	T.28
9042110000	SDIL 0.6x3.5x100	T.28
9042110000	SDIL 0.6x3.5x100	T.29
9042110000	SDIL 0.6x3.5x100	T.29
9042110000	SDIL 0.6x3.5x100	T.30
9042110000	SDIL 0.6x3.5x100	T.30
9042110000	SDIL 0.6x3.5x100	T.31
9042110000	SDIL 0.6x3.5x100	T.44
9042110000	SDIL 0.6x3.5x100	T.44
9042110000	SDIL 0.6x3.5x100	T.53
9042110000	SDIL 0.6x3.5x100	T.55
9042110000	SDIL 0.6x3.5x100	T.57
9042110000	SDIL 0.6x3.5x100	T.58
9042110000	SDIL 0.6x3.5x100	T.58
9042110000	SDIL 0.6x3.5x100	T.61
9042130000	SDIL 1.0x5.5x125	T.10
9042130000	SDIL 1.0x5.5x125	T.10
9042130000	SDIL 1.0x5.5x125	T.11
9042130000	SDIL 1.0x5.5x125	T.20
9042130000	SDIL 1.0x5.5x125	T.21
9042130000	SDIL 1.0x5.5x125	T.48
9042130000	SDIL 1.0x5.5x125	T.48
9042130000	SDIL 1.0x5.5x125	T.50
9042130000	SDIL 1.0x5.5x125	T.50
9042130000	SDIL 1.0x5.5x125	T.52
9042130000	SDIL 1.0x5.5x125	T.52
9042130000	SDIL 1.0x5.5x125	T.54
9042130000	SDIL 1.0x5.5x125	T.54
9042130000	SDIL 1.0x5.5x125	T.56
9042130000	SDIL 1.0x5.5x125	T.56
9042130000	SDIL 1.0x5.5x125	T.60
9042130000	SDIL 1.0x5.5x125	T.60

## 920000000

9201310000	BATTERIE 1,5V MICRO	T.194
------------	---------------------	-------

Order No.	Type	Page
-----------	------	------

9201310000	BATTERIE 1,5V MICRO	T.194
9201310000	BATTERIE 1,5V MICRO	T.195
9201310000	BATTERIE 1,5V MICRO	T.195
9201310000	BATTERIE 1,5V MICRO	T.196
9201310000	BATTERIE 1,5V MICRO	T.196
9201520000	SKAI TASCHE	T.194
9201520000	SKAI TASCHE	T.194
9205430000	CTIN CM 1.6/2.5	T.131
9205430000	CTIN CM 1.6/2.5	T.132
9205430000	CTIN CM 1.6/2.5	T.133
9205430000	CTIN CM 1.6/2.5	T.134
9205430000	CTIN CM 1.6/2.5	T.135
9205430000	CTIN CM 1.6/2.5	T.136
9205430000	CTIN CM 1.6/2.5	T.137
9205430000	CTIN CM 1.6/2.5	T.138
9205690000	SDIS 0.4X2.0X60	T.49
9205690000	SDIS 0.4X2.0X60	T.51

## 954000000

9540000000	ZEW 35	T.6
9540000000	ZEW 35	T.6
9540000000	ZEW 35	T.7
9540000000	ZEW 35	T.7
9540000000	ZEW 35	T.7
9540000000	ZEW 35	T.8
9540000000	ZEW 35	T.8
9540000000	ZEW 35	T.9
9540000000	ZEW 35	T.9
9540000000	ZEW 35	T.10
9540000000	ZEW 35	T.10
9540000000	ZEW 35	T.11
9540000000	ZEW 35	T.16
9540000000	ZEW 35	T.16
9540000000	ZEW 35	T.17
9540000000	ZEW 35	T.17
9540000000	ZEW 35	T.17
9540000000	ZEW 35	T.18
9540000000	ZEW 35	T.19
9540000000	ZEW 35	T.19
9540000000	ZEW 35	T.20
9540000000	ZEW 35	T.20
9540000000	ZEW 35	T.21
9540000000	ZEW 35	T.23
9540000000	ZEW 35	T.23
9540000000	ZEW 35	T.24
9540000000	ZEW 35	T.24
9540000000	ZEW 35	T.25
9540000000	ZEW 35	T.25
9540000000	ZEW 35	T.25
9540000000	ZEW 35	T.26
9540000000	ZEW 35	T.26
9540000000	ZEW 35	T.27
9540000000	ZEW 35	T.27
9540000000	ZEW 35	T.28
9540000000	ZEW 35	T.28
9540000000	ZEW 35	T.29
9540000000	ZEW 35	T.29
9540000000	ZEW 35	T.47
9540000000	ZEW 35	T.47
9540000000	ZEW 35	T.61

## 991000000

9918370000	DMS MANUELL 0,5-1,7	T.115
9918380000	DMS MANUELL 2,0-8,0	T.115
9918950000	VT	T.194
9918970000	VT CTB	T.194





# Addresses worldwide

Let's connect.

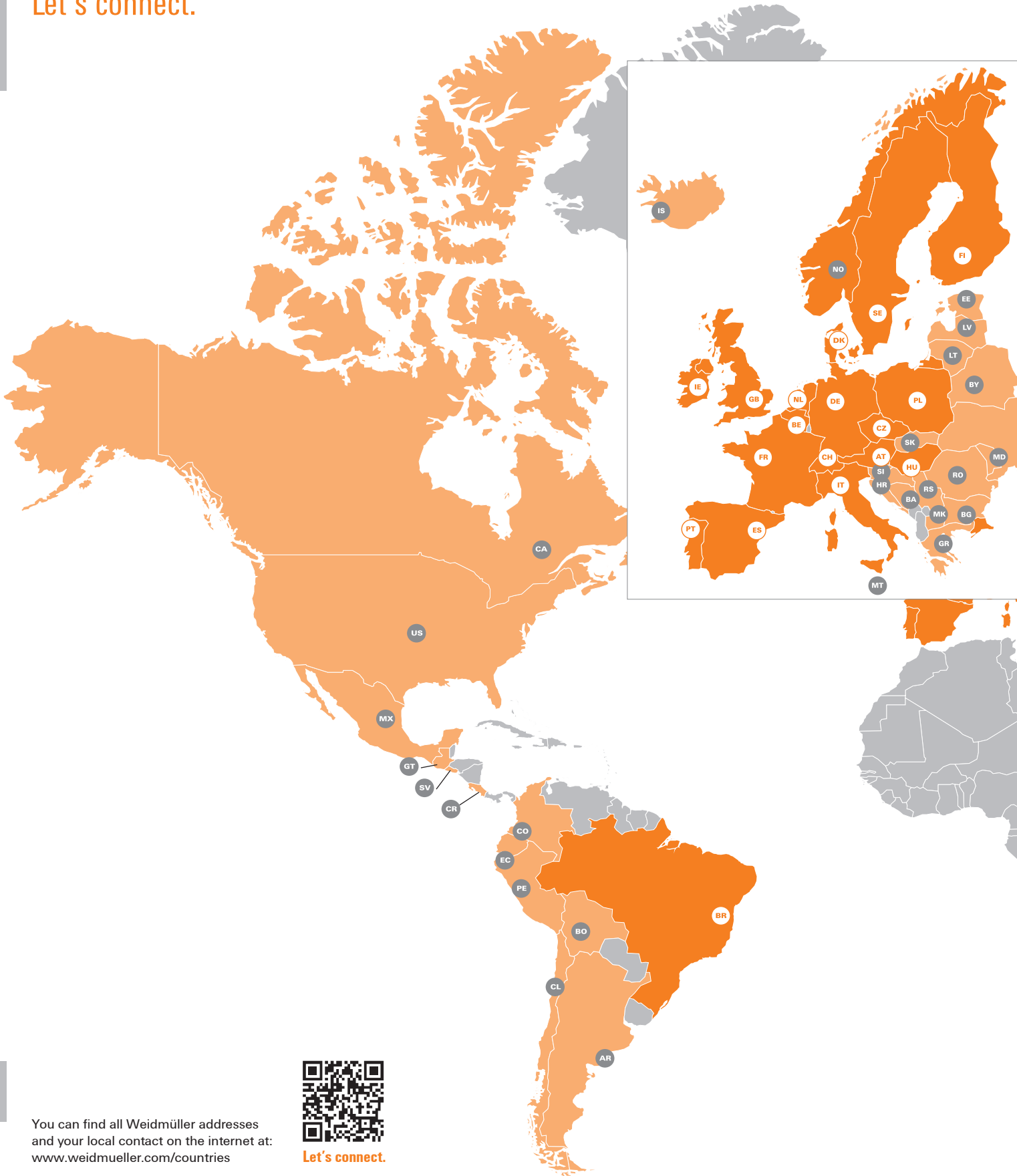

X

You can find all Weidmüller addresses and your local contact on the internet at: [www.weidmueller.com/countries](http://www.weidmueller.com/countries)



Let's connect.

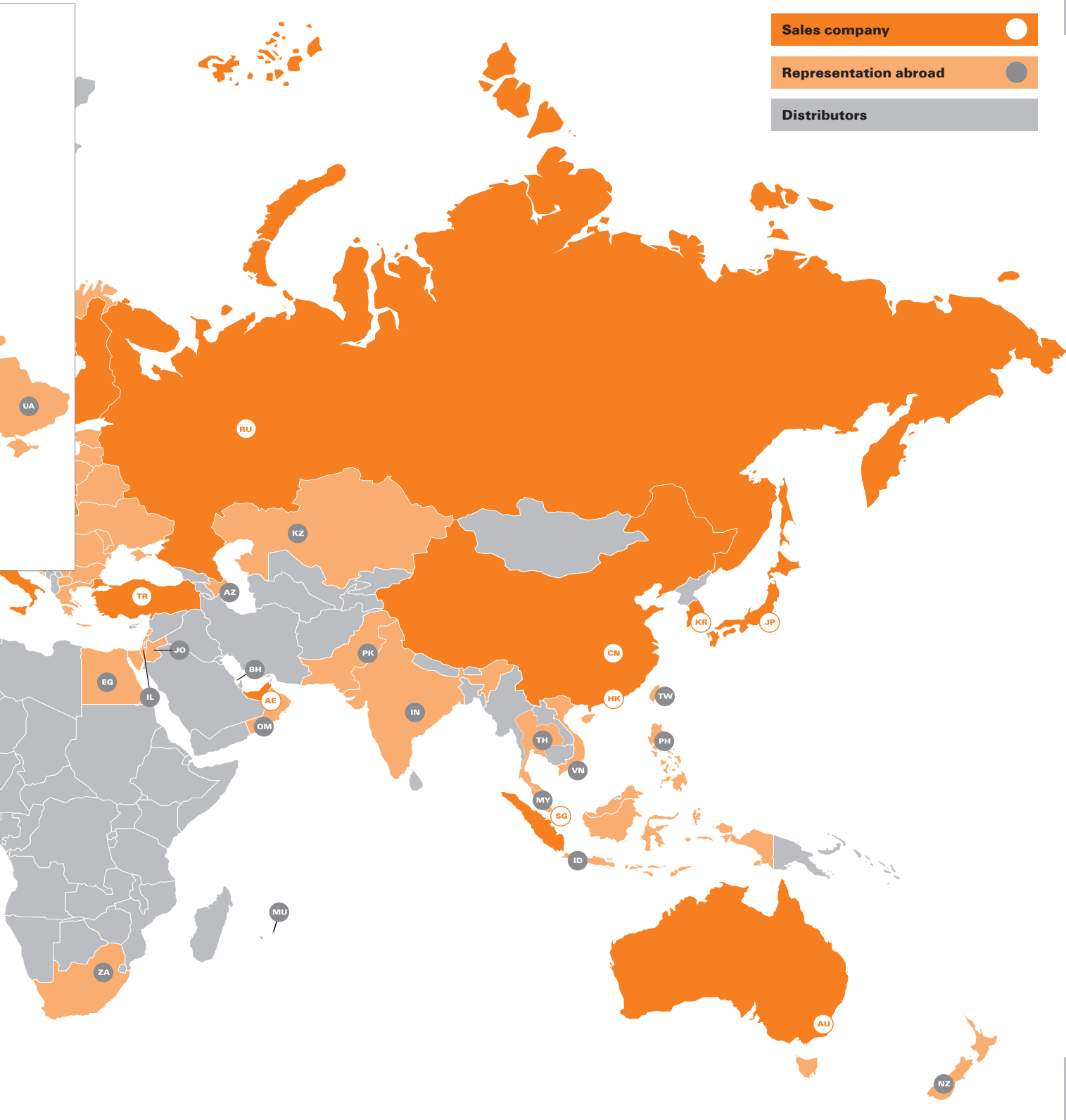

We cannot guarantee that there are no mistakes in the publications or software provided by us to the customer for the purpose of making orders. We try our best to quickly correct errors in our printed media.

**X**

All orders are based on our general terms of delivery, which can be reviewed on the websites of our group companies where you place your order. On demand we can also send the general terms of delivery to you.





## Weidmüller – Your partner in Industrial Connectivity

As experienced experts we support our customers and partners around the world with products, solutions and services in the industrial environment of power, signal and data. We are at home in their industries and markets and know the technological challenges of tomorrow. We are therefore continuously developing innovative, sustainable and useful solutions for their individual needs. Together we set standards in Industrial Connectivity.

Weidmüller Interface GmbH & Co. KG  
Klingenbergstraße 16  
32758 Detmold, Germany  
T +49 5231 14-0  
F +49 5231 14-292083  
info@weidmueller.com  
www.weidmueller.com

Your local Weidmüller partner can  
be found on our website:  
[www.weidmueller.com/countries](http://www.weidmueller.com/countries)

Made in Germany



Order number: 2504980000/04/2017/SMKD

## X-ON Electronics

Largest Supplier of Electrical and Electronic Components

*Click to view similar products for [weidmuller](#) manufacturer:*

Other Similar products are found below :

[8924550000](#) [56956](#) [0133660000](#) [6720000227](#) [6720005111](#) [68676](#) [69718](#) [EXO24CH](#) [7760056348](#) [7940000218](#) [8005181001](#) [8008180000](#)  
[8432240000](#) [8463580000](#) [8545830000](#) [8689870000](#) [8705640000](#) [9001080000](#) [9003720000](#) [9004250000](#) [9004780000](#) [9013260000](#)  
[9014100000](#) [9019040000](#) [9026010000](#) [9028630000](#) [903708](#) [9037350000](#) [9046290000](#) [9129643500](#) [913155](#) [9159530000](#) [919656](#) [919764](#)  
[9202230000](#) [9202850000](#) [9456750000](#) [9457913000](#) [980811](#) [980826](#) [9912800003](#) [9916080000](#) [9916280012](#) [9918380000](#) [9919371205](#)  
[9919371224](#) [9925710000](#) [9927480024](#) [1166660000](#) [11751](#)