

MPS 5/02 S TN B B

Weidmüller Interface GmbH & Co. KG

Klingenbergstraße 26

D-32758 Detmold

Germany

www.weidmueller.com

Product image

SNAP IN 

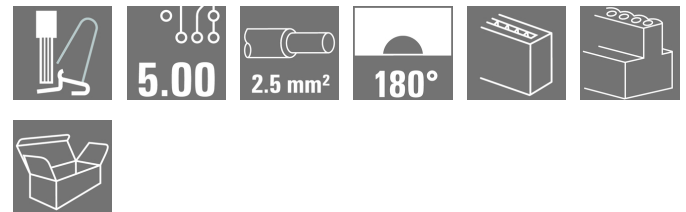

OMNIMATE® 4.0 - the next evolution step

OMNIMATE® 4.0 follows the trend of One Cable Technology (OCT). The modular concept enables the fast configuration of hybrid interfaces, which transmit data, signals and energy in a single connector. As a result, you can reduce the cabling effort in a wide variety of applications, simplify maintenance and accelerate automation processes. The unique SNAP IN connection is the backbone and speeds up the wiring process.

The fastest connection yet

- Fast, safe, and tool-free wiring due to unique SNAP IN connection
- Ready for Robot through "wire ready" delivery with open clamping point
- Optical and acoustic feedback indicates proper wiring

Create your own configuration

- Flexible configuration and ordering via the Weidmüller Configurator (WMC)
- Dispatch within three days – even for individually configured products
- Automatic offer preparation for the configured product

Simply configuration of modular hybrid connectors

- Flexible combination options for power, signal and data transmission
- Future-proof Single-Pair Ethernet technology

General ordering data

Version	PCB plug-in connector, female plug, Pitch in mm (P): 5.00 mm, Number of poles: 2, 180°, Box
Order No.	2741560000
Type	MPS 5/02 S TN B B
GTIN (EAN)	4064675054993
Qty.	168 pc(s).
Product data	IEC: 400 V / 26.8 A / 0.5 - 4 mm ² UL: 300 V / 14 A / AWG 18 - AWG 14
Packaging	Box

Creation date September 18, 2022 1:46:06 AM CEST

Catalogue status 09.09.2022 / We reserve the right to make technical changes.

MPS 5/02 S TN B B

Weidmüller Interface GmbH & Co. KG

Klingenbergstraße 26

D-32758 Detmold

Germany

www.weidmueller.com

Technical data

Dimensions and weights

Depth	34 mm	Depth (inches)	1.339 inch
Height	15.5 mm	Height (inches)	0.61 inch
Width	10.8 mm	Width (inches)	0.425 inch
Net weight	1.349 g		

System Parameters

Type of connection	Field connection		
Wire connection method	SNAP IN		
Pitch in mm (P)	5 mm		
Pitch in inches (P)	0.197 inch		
Conductor outlet direction	180°		
Number of poles	2		
L1 in mm	5 mm		
L1 in inches	0.197 inch		
Number of rows	1		
Pin series quantity	1		
Touch-safe protection acc. to DIN VDE 57 106	Safe from finger touch		
Touch-safe protection acc. to DIN VDE 0470	IP 20		
Protection degree	IP20		
Volume resistance	≤5 mΩ		
Stripping length	9 mm		
Stripping length tolerance	min.	8 mm	
	max.	10 mm	
Plugging cycles	25		
Plugging force/pole, max.	8.5 N		
Pulling force/pole, max.	8.5 N		

Material data

Insulating material	PBT GF	Colour	black
Colour chart (similar)	RAL 9011	Insulating material group	I
Comparative Tracking Index (CTI)	≥ 600	UL 94 flammability rating	V-0
Contact material	CuSn	Contact surface	tinned
Storage temperature, min.	-25 °C	Storage temperature, max.	55 °C
Operating temperature, min.	-50 °C	Operating temperature, max.	100 °C

Conductors suitable for connection

Clamping range, min.	0.5 mm ²
Clamping range, max.	2.5 mm ²
Solid, min. H05(07) V-U	0.5 mm ²
Solid, max. H05(07) V-U	2.5 mm ²
Flexible, min. H05(07) V-K	0.5 mm ²
Flexible, max. H05(07) V-K	4 mm ²
w. plastic collar ferrule, DIN 46228 pt 4, 0.5 mm ² min.	
w. plastic collar ferrule, DIN 46228 pt 4, 2.5 mm ² max.	
w. wire end ferrule, DIN 46228 pt 1, min.	0.5 mm ²
w. wire end ferrule, DIN 46228 pt 1, max.	2.5 mm ²
Outer diameter of insulation, max.	4 mm

Creation date September 18, 2022 1:46:06 AM CEST

MPS 5/02 S TN B B

Weidmüller Interface GmbH & Co. KG
 Klingenbergstraße 26
 D-32758 Detmold
 Germany

www.weidmueller.com

Technical data

Clampable conductor	Cross-section for conductor connection	nominal	0.5 mm ²
	wire end ferrule	Stripping length	nominal 12 mm
		Recommended wire-end ferrule	H0.5/16 OR
		Stripping length	nominal 10 mm
		Recommended wire-end ferrule	H0.5/10
	Cross-section for conductor connection	nominal	0.75 mm ²
	wire end ferrule	Stripping length	nominal 12 mm
		Recommended wire-end ferrule	H0,75/16 W
		Stripping length	nominal 10 mm
		Recommended wire-end ferrule	H0,75/10
	Cross-section for conductor connection	nominal	1 mm ²
	wire end ferrule	Stripping length	nominal 12 mm
		Recommended wire-end ferrule	H1.0/16 GE
		Stripping length	nominal 10 mm
		Recommended wire-end ferrule	H1.0/10
	Cross-section for conductor connection	nominal	1.5 mm ²
	wire end ferrule	Stripping length	nominal 12 mm
		Recommended wire-end ferrule	H1.5/16 R
		Stripping length	nominal 10 mm
		Recommended wire-end ferrule	H1.5/10
Cross-section for conductor connection	nominal	2.5 mm ²	
wire end ferrule	Stripping length	nominal 10 mm	
	Recommended wire-end ferrule	H2.5/15D BL	
	Stripping length	nominal 10 mm	
	Recommended wire-end ferrule	H2.5/10	

Reference text The outside diameter of the plastic collar should not be larger than the pitch (P), Length of ferrules is to be chosen depending on the product and the rated voltage.

Rated data acc. to IEC

tested acc. to standard	IEC 60664-1, IEC 61984	Rated current, min. number of poles (Tu=20°C)	26.8 A
Rated current, max. number of poles (Tu=20°C)	19.7 A	Rated current, min. number of poles (Tu=40°C)	23.1 A
Rated current, max. number of poles (Tu=40°C)	16.9 A	Rated voltage for surge voltage class / pollution degree II/2	400 V
Rated voltage for surge voltage class / pollution degree III/2	320 V	Rated voltage for surge voltage class / pollution degree III/3	250 V
Rated impulse voltage for surge voltage class/ pollution degree II/2	4 kV	Rated impulse voltage for surge voltage class/ pollution degree III/2	4 kV
Rated impulse voltage for surge voltage class/ contamination degree III/3	4 kV		

MPS 5/02 S TN B B

Weidmüller Interface GmbH & Co. KG

Klingenbergstraße 26

D-32758 Detmold

Germany

www.weidmueller.com

Technical data

Rated data acc. to UL 1059

Institute (cURus)



Certificate No. (cURus)

E60693

Rated voltage (Use group B / UL 1059) 300 V

Rated voltage (Use group D / UL 1059) 300 V

Rated current (Use group B / UL 1059) 14 A

Rated current (Use group D / UL 1059) 10 A

Wire cross-section, AWG, min. AWG 18

Wire cross-section, AWG, max. AWG 14

Reference to approval values

Specifications are maximum values, details - see approval certificate.

Classifications

ETIM 6.0	EC002638	ETIM 7.0	EC002638
ETIM 8.0	EC002638	ECLASS 9.0	27-44-03-09
ECLASS 9.1	27-44-03-09	ECLASS 10.0	27-44-03-09
ECLASS 11.0	27-46-02-02	ECLASS 12.0	27-46-02-02

Important note

IPC conformity

Conformity: The products are developed, manufactured and delivered according international recognized standards and norms and comply with the assured properties in the data sheet resp. fulfill decorative properties in accordance with IPC-A-610 "Class 2". Further claims on the products can be evaluated on request.

Notes

- Rated current related to rated cross-section & min. No. of poles.
- P on drawing = pitch
- Rated data refer only to the component itself. Clearance and creepage distances to other components are to be designed in accordance with the relevant application standards.
- Wire end ferrule without plastic collar to DIN 46228/1
- Long term storage of the product with average temperature of 50 °C and average humidity 70%, 36 months

Approvals

Approvals



UL File Number Search

UL Website

Certificate No. (cURus)

E60693

Downloads

Engineering Data	CAD data – STEP
Product Change Notification	20210526 Technical change to MPS 5 and MHS 5 H 20210526 Technische Änderung zu MPS 5 und MHS 5 H 20210602 Technical change to MPS 5 20210602 Technische Änderung zu MPS 5
User Documentation	Assembly instructions MPS 5 EN DE
Catalogues	Catalogues in PDF-format

Creation date September 18, 2022 1:46:06 AM CEST

Catalogue status 09.09.2022 / We reserve the right to make technical changes.

4

MPS 5/02 S TN B B

Weidmüller Interface GmbH & Co. KG
 Klingenbergstraße 26
 D-32758 Detmold
 Germany

www.weidmueller.com

Drawings

Product image

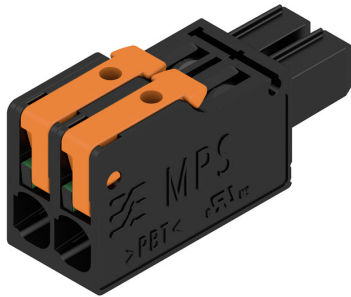

Dimensional drawing

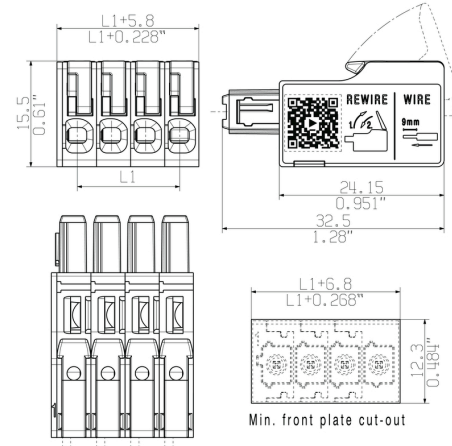

Derating curve

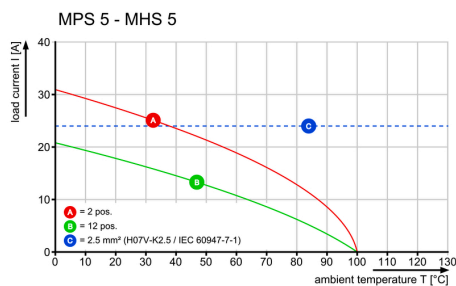

Product benefits



Fastest connection technology SNAP IN

Product benefits



Acoustic and visual feedback

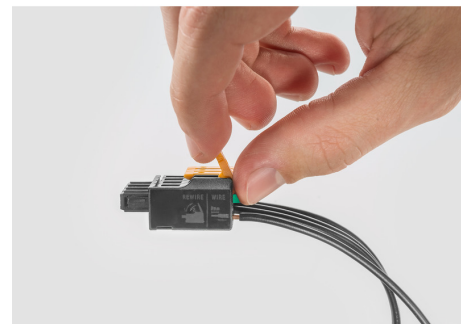

The reproduction, distribution and utilization of this document as well as the communication of its contents without explicit authorization is prohibited. Offenders will be held liable for the payment of damages. Weidmueller exclusively reserves the right to file for patents, utility models or designs.

© Weidmueller Interface GmbH & Co. KG

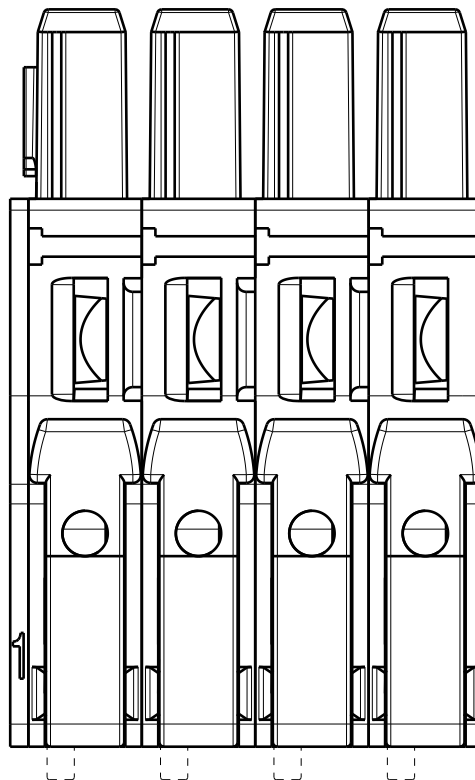
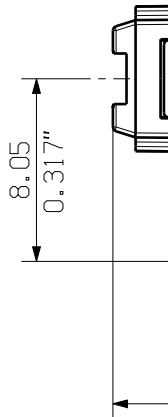
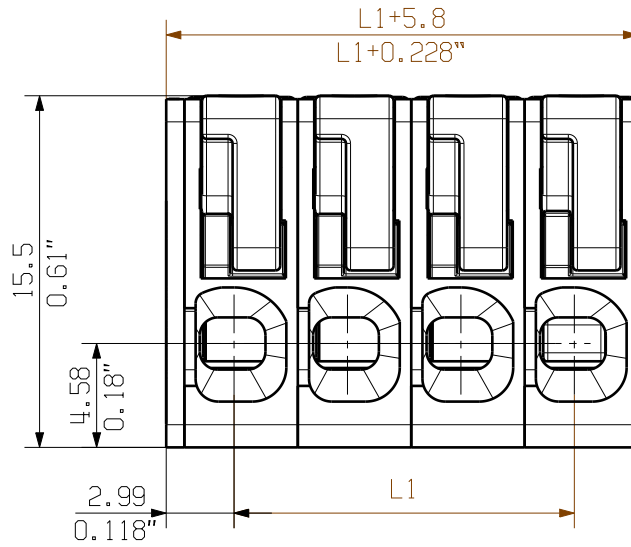

For the mounting of PCBs, it should be noted that the rated data given in the catalogue relates only to the connection elements. The necessary creepage and clearance paths must be observed in connection with the respective applicant in accordance to VDE 0110. The current-carrying capacity and pitch tolerance is to be determined according to DIN IEC 326 part 3 very fine.

Weidmueller connectors are tested to the DIN VDE 0627 standard, and are valid for its field of application. Provided that the connectors are used to the intended purpose, all requirements with respect to the occurring of electrical, mechanical, thermic and corrosive stress will be satisfied.

X-ON Electronics

Largest Supplier of Electrical and Electronic Components

Click to view similar products for [Pluggable Terminal Blocks](#) category:

Click to view products by [Weidmuller](#) manufacturer:

Other Similar products are found below :

[57.510.0053](#) [MC 1.5/ 6-ST-3.5 GY AU](#) [ET02015000J0G](#) [734-104](#) [734-302](#) [860505](#) [860516](#) [860810](#) [GBPACX-12](#) [PV05-5,08-K](#) [PVP02-5,00](#)
[PVP03-3,50](#) [PVP04-3,50](#) [PVS02-5,00](#) [1-1986160-3](#) [1377680000](#) [1531000000](#) [1546228-5](#) [ELFP03110](#) [ELFP10210](#) [ELVP03100](#) [1700101](#)
[1700410](#) [1702246](#) [1705229](#) [1710175](#) [1714537](#) [1717806](#) [1719600](#) [1728941](#) [1734692](#) [1734795](#) [1740628](#) [1740990](#) [1746952](#) [1750207](#)
[1752441](#) [1752865](#) [1754115](#) [1754144](#) [1756913](#) [1760051](#) [1760336](#) [1765111](#) [1777701](#) [1783410](#) [1800227](#) [1800269](#) [1800272](#) [1801080](#)