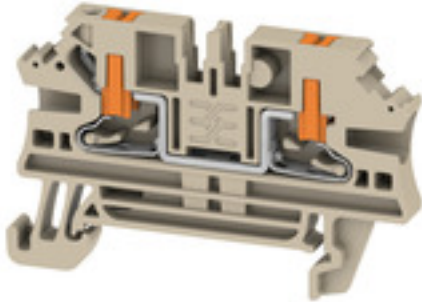

**AL2C 2.5****Weidmüller Interface GmbH & Co. KG**

Klingenbergstraße 26

D-32758 Detmold

Germany

[www.weidmueller.com](http://www.weidmueller.com)

To feed through power, signal, and data is the classical requirement in electrical engineering and panel building. The insulating material, the connection system and the design of the terminal blocks are the differentiating features. A feed-through terminal block is suitable for joining and/or connecting one or more conductors. They could have one or more connection levels that are on the same potential or insulated against one another.

**General ordering data**

Order No.	<a href="#">2847200000</a>
Type	AL2C 2.5
GTIN (EAN)	4064675456643
Qty.	50 pc(s).

## AL2C 2.5

Weidmüller Interface GmbH &amp; Co. KG

Klingenbergstraße 26

D-32758 Detmold

Germany

www.weidmueller.com

## Technical data

## Dimensions and weights

Depth	36.5 mm	Depth (inches)	1.437 inch
Height	57 mm	Height (inches)	2.244 inch
Width	5.1 mm	Width (inches)	0.201 inch
Net weight	6.223 g		

## Temperatures

Storage temperature	-25 °C...55 °C	Continuous operating temp., min.	-60 °C
Continuous operating temp., max.	130 °C		

## Material data

Material	Wemid	Colour	dark beige
Colour of operational elements	orange	UL 94 flammability rating	V-0

## System specifications

End cover plate required	Yes	Number of potentials	1
Number of levels	1	Number of clamping points per level	2
Number of potentials per tier	1	Levels cross-connected internally	No
Rail	TS 35	N-function	No
PE function	No	PEN function	No

## Additional technical data

Open sides	right	Snap-on	Yes
Type of fixing	Snap-on	Type of mounting	TS 35

## Conductors for clamping (rated connection)

Blade size	0.6 x 3.5 mm	Clamping range, max.	2.5 mm <sup>2</sup>
Clamping range, min.	0.14 mm <sup>2</sup>	Connection cross-section, stranded, max.	2.5 mm <sup>2</sup>
Connection cross-section, stranded, min.	0.5 mm <sup>2</sup>	Connection direction	top, on side
Gauge to IEC 60947-1	A3	Number of connections	2
Stripping length	10 mm	Twin wire-end ferrules, max.	0.75 mm <sup>2</sup>
Twin wire-end ferrules, min.	0.5 mm <sup>2</sup>	Type of connection	PUSH IN
Wire connection cross section AWG, max.	AWG 12	Wire connection cross section AWG, min.	AWG 28
Wire connection cross section, finely stranded, max.	2.5 mm <sup>2</sup>	Wire connection cross section, finely stranded, min.	0.5 mm <sup>2</sup>
Wire connection cross-section, finely stranded with wire-end ferrules DIN 46228/1, max.	2.5 mm <sup>2</sup>	Wire connection cross-section, finely stranded with wire-end ferrules DIN 46228/1, min.	0.5 mm <sup>2</sup>
Wire connection cross-section, finely stranded with wire-end ferrules DIN 46228/4, max.	2.5 mm <sup>2</sup>	Wire connection cross-section, finely stranded with wire-end ferrules DIN 46228/4, min.	0.5 mm <sup>2</sup>
Wire connection cross-section, solid core, max.	2.5 mm <sup>2</sup>	Wire connection cross-section, solid core, min.	0.5 mm <sup>2</sup>

## General

Rail	TS 35	Standards	IEC 60947-7-1
Wire connection cross section AWG, max.	AWG 12	Wire connection cross section AWG, min.	AWG 28

Creation date May 23, 2023 9:01:01 PM CEST

## AL2C 2.5

Weidmüller Interface GmbH &amp; Co. KG

Klingenbergstraße 26

D-32758 Detmold

Germany

www.weidmueller.com

## Technical data

## Rating data

Rated cross-section	2.5 mm <sup>2</sup>	Rated voltage	800 V
Rated current	24 A	Current at maximum wires	24 A
Standards	IEC 60947-7-1	Volume resistance according to IEC 60947-7-x	1.33 mΩ
Rated impulse withstand voltage	8 kV	Power loss in accordance with IEC 60947-7-x	0.77 W
Pollution severity	3	Surge voltage category	III

## Classifications

ETIM 6.0	EC000897	ETIM 7.0	EC000897
ETIM 8.0	EC000897	ECLASS 9.0	27-14-11-20
ECLASS 9.1	27-14-11-20	ECLASS 10.0	27-14-11-20
ECLASS 11.0	27-14-11-20	ECLASS 12.0	27-14-11-20

## Approvals

Approvals



## Downloads

Approval/Certificate/Document of Conformity	<a href="#">Attestation of Conformity</a> <a href="#">IECEX Certificate</a> <a href="#">ATEX Certificate</a>
Engineering Data	<a href="#">CAD data – STEP</a>
User Documentation	<a href="#">NTI AL2C 2.5</a>
Catalogues	<a href="#">Catalogues in PDF-format</a>

**Data sheet**

**AL2C 2.5**

**Weidmüller Interface GmbH & Co. KG**  
Klingenbergstraße 26  
D-32758 Detmold  
Germany

[www.weidmueller.com](http://www.weidmueller.com)

**Drawings**

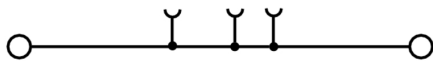

## AL2C 2.5

**Weidmüller Interface GmbH & Co. KG**  
 Klingenbergstraße 26  
 D-32758 Detmold  
 Germany

[www.weidmueller.com](http://www.weidmueller.com)

## Accessories

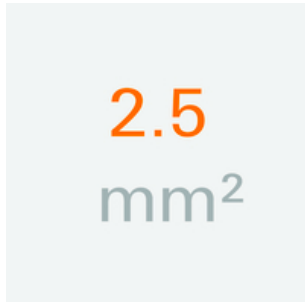
2.5 mm<sup>2</sup>

The plug-in cross-connections feature easy handling and quick installation. This saves a great deal of time during installation in comparison with screwed solutions.

## General ordering data

Type	ZQV 2.5N/3 BL
Order No.	<a href="#">1527770000</a>
GTIN (EAN)	4050118448641
Qty.	60 pc(s).
Type	ZQV 2.5N/7 BL
Order No.	<a href="#">1527830000</a>
GTIN (EAN)	4050118448603
Qty.	20 pc(s).
Type	ZQV 2.5N/9 RD
Order No.	<a href="#">2108900000</a>
GTIN (EAN)	4050118448474
Qty.	20 pc(s).
Type	ZQV 2.5N/50
Order No.	<a href="#">1527730000</a>
GTIN (EAN)	4050118411362
Qty.	5 pc(s).
Type	ZQV 2.5N/7 RD
Order No.	<a href="#">2108810000</a>
GTIN (EAN)	4050118448498
Qty.	20 pc(s).
Type	ZQV 2.5N/3 RD
Order No.	<a href="#">2108690000</a>
GTIN (EAN)	4050118448535
Qty.	60 pc(s).
Type	ZQV 2.5N/6
Order No.	<a href="#">1527630000</a>
GTIN (EAN)	4050118448429
Qty.	20 pc(s).
Type	ZQV 2.5N/5 RD
Order No.	<a href="#">2108710000</a>
GTIN (EAN)	4050118448511
Qty.	20 pc(s).
Type	ZQV 2.5N/10
Order No.	<a href="#">1527690000</a>
GTIN (EAN)	4050118447989
Qty.	20 pc(s).
Type	ZQV 2.5N/8 RD
Order No.	<a href="#">2108870000</a>
GTIN (EAN)	4050118448481
Qty.	20 pc(s).

Creation date May 23, 2023 9:01:01 PM CEST

## AL2C 2.5

Weidmüller Interface GmbH &amp; Co. KG

Klingenbergstraße 26

D-32758 Detmold

Germany

www.weidmueller.com

## Accessories

Type	ZQV 2.5N/9
Order No.	<a href="#">1527680000</a>
GTIN (EAN)	4050118447996
Qty.	20 pc(s).
Type	ZQV 2.5N/9 BL
Order No.	<a href="#">1527870000</a>
GTIN (EAN)	4050118448580
Qty.	20 pc(s).
Type	ZQV 2.5N/50 RD
Order No.	<a href="#">2109000000</a>
GTIN (EAN)	4050118486001
Qty.	5 pc(s).
Type	ZQV 2.5N/6 BL
Order No.	<a href="#">1527820000</a>
GTIN (EAN)	4050118448610
Qty.	20 pc(s).
Type	ZQV 2.5N/8 BL
Order No.	<a href="#">1527840000</a>
GTIN (EAN)	4050118448597
Qty.	20 pc(s).
Type	ZQV 2.5N/2
Order No.	<a href="#">1527540000</a>
GTIN (EAN)	4050118448467
Qty.	60 pc(s).
Type	ZQV 2.5N/2 RD
Order No.	<a href="#">2108470000</a>
GTIN (EAN)	4050118448542
Qty.	60 pc(s).
Type	ZQV 2.5N/20 BL
Order No.	<a href="#">1527890000</a>
GTIN (EAN)	4050118448566
Qty.	20 pc(s).
Type	ZQV 2.5N/8
Order No.	<a href="#">1527670000</a>
GTIN (EAN)	4050118448405
Qty.	20 pc(s).
Type	ZQV 2.5N/4 RD
Order No.	<a href="#">2108700000</a>
GTIN (EAN)	4050118448528
Qty.	60 pc(s).
Type	ZQV 2.5N/10 BL
Order No.	<a href="#">1527880000</a>
GTIN (EAN)	4050118448573
Qty.	20 pc(s).
Type	ZQV 2.5N/10 RD
Order No.	<a href="#">2108910000</a>
GTIN (EAN)	4050118486018
Qty.	20 pc(s).
Type	ZQV 2.5N/5
Order No.	<a href="#">1527620000</a>
GTIN (EAN)	4050118448436
Qty.	20 pc(s).

Creation date May 23, 2023 9:01:01 PM CEST

Catalogue status 12.05.2023 / We reserve the right to make technical changes.

## AL2C 2.5

**Weidmüller Interface GmbH & Co. KG**  
Klingenbergstraße 26  
D-32758 Detmold  
Germany

[www.weidmueller.com](http://www.weidmueller.com)

## Accessories

Type	ZQV 2.5N/2 BL
Order No.	<a href="#">1527740000</a>
GTIN (EAN)	4050118448658
Qty.	60 pc(s).
Type	ZQV 2.5N/20
Order No.	<a href="#">1527720000</a>
GTIN (EAN)	4050118447972
Qty.	20 pc(s).
Type	ZQV 2.5N/5 BL
Order No.	<a href="#">1527790000</a>
GTIN (EAN)	4050118448627
Qty.	20 pc(s).
Type	ZQV 2.5N/20 RD
Order No.	<a href="#">2108920000</a>
GTIN (EAN)	4050118485899
Qty.	20 pc(s).
Type	ZQV 2.5N/7
Order No.	<a href="#">1527640000</a>
GTIN (EAN)	4050118448412
Qty.	20 pc(s).
Type	ZQV 2.5N/50 BL
Order No.	<a href="#">1527920000</a>
GTIN (EAN)	4050118448559
Qty.	5 pc(s).
Type	ZQV 2.5N/4 BL
Order No.	<a href="#">1527780000</a>
GTIN (EAN)	4050118448634
Qty.	60 pc(s).
Type	ZQV 2.5N/3
Order No.	<a href="#">1527570000</a>
GTIN (EAN)	4050118448450
Qty.	60 pc(s).
Type	ZQV 2.5N/4
Order No.	<a href="#">1527590000</a>
GTIN (EAN)	4050118448443
Qty.	60 pc(s).
Type	ZQV 2.5N/6 RD
Order No.	<a href="#">2108720000</a>
GTIN (EAN)	4050118448504
Qty.	20 pc(s).

**AL2C 2.5**

**Weidmüller Interface GmbH & Co. KG**  
 Klingenbergstraße 26  
 D-32758 Detmold  
 Germany

www.weidmueller.com

**Accessories**

**A-Series**



A partition plate is used for the optical separation of circuits or used for electrical isolation from neighbouring cross-connectors. In contrast to the end plate, the contour can be larger than the adjacent terminal blocks. However, it should not be smaller, as otherwise the required clearance and creepage distances within the application can no longer be maintained.

**General ordering data**

Type	APP 1	Version
Order No.	<a href="#">2488970000</a>	A-series, Partition plate
GTIN (EAN)	4050118499216	
Qty.	50 pc(s).	

**Custom printing**



WS markers are the perfect match for the W-series connectors. Thanks to their system compatibility, the WS tags can also be used with the I-series and the Z-series. The large marking surfaces do not only permit long character strings but also multi-line text. WS markers are ideal for labels with long, customised character strings. Thanks to the proven MultiCard format, printing with PrintJet CONNECT oder/or Plotter is possible.

- Can be fitted in strips or individually
- Markers in proven MultiCard format

**For custom printing:** Please send us a file of our labeling software M-Print PRO or M-Print PRO Online (without installation) for your labeling specifications.

**General ordering data**

Type	WS 10/5 MC M SDR	Version
Order No.	<a href="#">1792010000</a>	WS, Terminal marker, 10 x 5 mm, Pitch in mm (P): 5.00 Weidmueller, Allen-Bradley, To customer specification
GTIN (EAN)	4032248223879	
Qty.	144 pc(s).	
Type	WS 10/5 MC SDR	Version
Order No.	<a href="#">1635010000</a>	WS, Terminal marker, 10 x 5 mm, Pitch in mm (P): 5.00 Weidmueller, Allen-Bradley, To customer specification
GTIN (EAN)	4008190456634	
Qty.	144 pc(s).	
Type	WS 10/5 M PLUS MC SDR	Version
Order No.	<a href="#">2007770000</a>	WS, Terminal marker, 10 x 5 mm, Pitch in mm (P): 5.00 Weidmueller, Allen-Bradley, To customer specification
GTIN (EAN)	4050118393279	
Qty.	120 pc(s).	



## Data sheet

### AL2C 2.5

**Weidmüller Interface GmbH & Co. KG**  
 Klingenbergstraße 26  
 D-32758 Detmold  
 Germany

[www.weidmueller.com](http://www.weidmueller.com)

## Accessories

Type	WS 10/5 PLUS MC SDR	Version
Order No.	<a href="#">1046320000</a>	WS, Terminal marker, 10 x 5 mm, Pitch in mm (P): 5.00 Weidmueller,
GTIN (EAN)	4032248782024	Allen-Bradley, To customer specification
Qty.	120 pc(s).	

### A-Series



Warning covers with a flash symbol provide more safety for man and machine. They are used where external voltage must be indicated within the application.

#### General ordering data

Type	AAM 2.5 YE FLASH	Version
Order No.	<a href="#">2635550000</a>	Terminal marker, 8 x 5.1 mm, Pitch in mm (P): 5.00 yellow
GTIN (EAN)	4050118674095	
Qty.	40 pc(s).	

### Z-Series

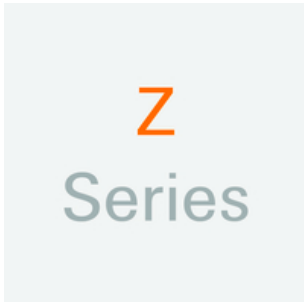

Weidmüller's range of products includes end brackets that guarantee a permanent, reliable mounting on the terminal rail and prevent sliding. Versions with and without screws are available. The end brackets include marking options, also for group markers, and also a test plug holder.

#### General ordering data

Type	ZST 1	Version
Order No.	<a href="#">1269070000</a>	Accessories, Accessories holder
GTIN (EAN)	4050118094091	
Qty.	25 pc(s).	

Type	ZST	Version
Order No.	<a href="#">1678680000</a>	Z-series, Accessories holder
GTIN (EAN)	4008190466770	
Qty.	10 pc(s).	

**AL2C 2.5**

**Weidmüller Interface GmbH & Co. KG**  
 Klingenbergstraße 26  
 D-32758 Detmold  
 Germany

www.weidmueller.com

**Accessories**

**Plus**

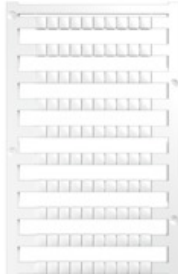

The Dekafix (DEK) marker is the universal marker for all conductor and plug-in connectors as well as for electronic sub-assemblies. The system is ideal for short number sequences and covers a wide range of ready-printed markers.

Strips for fast installation in only one work step. The printing is easy to read, rich in contrast and available in various widths.

- Large range of ready-to-use markers
- Strips for fast installation
- Terminal markers, suitable for all Weidmüller cable connectors
- Available as blank MultiCard or with standard printing

**For custom printing:** Please send us a file of our labeling software M-Print PRO or M-Print PRO Online (without installation) for your labeling specifications.

**General ordering data**

Type	DEK 5/5 PLUS MC NE WS	Version
Order No.	<a href="#">1854490000</a>	Dekafix, Terminal marker, 5 x 5 mm, Pitch in mm (P): 5.00
GTIN (EAN)	4032248393596	Weidmueller, white
Qty.	1,000 pc(s).	
Type	DEK 5/5 PLUS MC NE GE	Version
Order No.	<a href="#">1907520000</a>	Dekafix, Terminal marker, 5 x 5 mm, Pitch in mm (P): 5.00
GTIN (EAN)	4032248532100	Weidmueller, yellow
Qty.	1,000 pc(s).	

## AL2C 2.5

**Weidmüller Interface GmbH & Co. KG**  
 Klingenbergstraße 26  
 D-32758 Detmold  
 Germany

[www.weidmueller.com](http://www.weidmueller.com)

## Accessories

## Custom printing



The Dekafix (DEK) marker is the universal marker for all conductor and plug-in connectors as well as for electronic sub-assemblies. The system is ideal for short number sequences and covers a wide range of ready-printed markers.

Strips for fast installation in only one work step. The printing is easy to read, rich in contrast and available in various widths.

- Large range of ready-to-use markers
- Strips for fast installation
- Terminal markers, suitable for all Weidmüller cable connectors
- Available as blank MultiCard or with standard printing

**For custom printing:** Please send us a file of our labeling software M-Print PRO or M-Print PRO Online (without installation) for your labeling specifications.

## General ordering data

Type	DEK 5/5 S MC SDR	Version
Order No.	<a href="#">1341590000</a>	Dekafix, Terminal marker, 5 x 5 mm, Pitch in mm (P): 5.00
GTIN (EAN)	4050118146042	Weidmueller, To customer specification
Qty.	80 pc(s).	
Type	DEK 5/5 MC SDR	Version
Order No.	<a href="#">1609810000</a>	Dekafix, Terminal marker, 5 x 5 mm, Pitch in mm (P): 5.00
GTIN (EAN)	4008190456597	Weidmueller, To customer specification
Qty.	200 pc(s).	
Type	DEK 5/5 PLUS MC SDR	Version
Order No.	<a href="#">1854500000</a>	Dekafix, Terminal marker, 5 x 5 mm, Pitch in mm (P): 5.00
GTIN (EAN)	4032248393602	Weidmueller, To customer specification
Qty.	200 pc(s).	

**AL2C 2.5**

**Weidmüller Interface GmbH & Co. KG**  
 Klingenbergstraße 26  
 D-32758 Detmold  
 Germany

www.weidmueller.com

**Accessories**

**DEK 5/5**



**WS/ DEK**

MultiMark terminal markers use an innovative composite material made from two components. The hard base contour of the marker snaps securely into the connector. The elastic surface finish makes the marker easy to mount. This specially punched material enables the strips to be stretched to accommodate the slight variations in spacing that tend to add up, especially with long terminal blocks. Another advantage: the excellent printability of the surface material guarantees durable and wear-resistant labelling. A print resolution of 300 dpi also produces a very legible script.

**Your benefits with MultiMark**

- Firm hold and durable printing
- Continuous strips save installation time
- Easy mounting thanks to an innovative composite material
- Large label field for optimal legibility
- High flexibility thanks to manufacturer independence

**General ordering data**

Type	DEK 5/5 MM WS	Version	
Order No.	<a href="#">2007110000</a>	Dekafix, Terminal marker, 5 x 5 mm, Weidmueller, white	
GTIN (EAN)	4050118391862		
Qty.	800 pc(s).		

**A-Series**



Test adapters and test plugs are used for the electrical connection between terminal blocks and the test equipment. In this way, an electrical contact can be established in the wired state and measurements can be done easily.

**General ordering data**

Type	ATPG 2.5 MI-R
Order No.	<a href="#">1991960000</a>
GTIN (EAN)	4050118376685
Qty.	50 pc(s).
Type	ATPG 1.5-10 L
Order No.	<a href="#">1991890000</a>
GTIN (EAN)	4050118376647
Qty.	50 pc(s).

## AL2C 2.5

**Weidmüller Interface GmbH & Co. KG**  
Klingenbergstraße 26  
D-32758 Detmold  
Germany

www.weidmueller.com

## Accessories

Type	ATPG 2.5/3
Order No.	<a href="#">2041190000</a>
GTIN (EAN)	4050118409604
Qty.	25 pc(s).

Type	ATPG 2.5/5
Order No.	<a href="#">2041180000</a>
GTIN (EAN)	4050118409505
Qty.	25 pc(s).

## Digital current clamp devices



Digital current clamp devices and attachments and adapters are used for measuring AC and DC currents. The significant advantage of these devices is that you can make a measurement without breaking the flow of current.

## General ordering data

Type	ZUB MULTIMETER	Version	
Order No.	<a href="#">9205270000</a>	Multimeter	
GTIN (EAN)	4032248723522		
Qty.	1 pc(s).		

## Slotted screwdriver

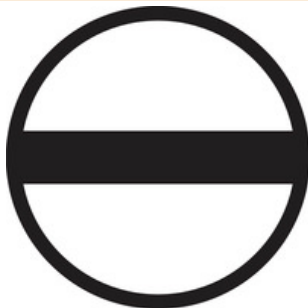

VDE insulated screwdriver sets, for working on live parts up to 1000 V AC and 1500 V DC, DIN EN 60900. IEC 900. Each piece is "GS" safety tested. Blade made from fully hardened, high-alloy chromium-vanadium-molybdenum steel, gun-metal finish.

## General ordering data

Type	SDIS SLIM 0.6X3.5X100	Version	
Order No.	<a href="#">2749610000</a>	Mounting tool, Blade width (B): 3.5 mm, Blade length: 100 mm, Blade	
GTIN (EAN)	4050118896350	thickness (A): 0.6 mm	
Qty.	1 pc(s).		

## AL2C 2.5

Weidmüller Interface GmbH &amp; Co. KG

Klingenbergstraße 26

D-32758 Detmold

Germany

www.weidmueller.com

## Accessories

## Blank



WS markers are the perfect match for the W-series connectors. Thanks to their system compatibility, the WS tags can also be used with the I-series and the Z-series. The large marking surfaces do not only permit long character strings but also multi-line text. WS markers are ideal for labels with long, customised character strings. Thanks to the proven MultiCard format, printing with PrintJet CONNECT oder/or Plotter is possible.

- Can be fitted in strips or individually
- Markers in proven MultiCard format

**For custom printing:** Please send us a file of our labeling software M-Print PRO or M-Print PRO Online (without installation) for your labeling specifications.

## General ordering data

Type	WS 10/5 MC NE RT	Version
Order No.	<a href="#">1773531686</a>	WS, Terminal marker, 10 x 5 mm, Pitch in mm (P): 5.00 Weidmueller,
GTIN (EAN)	4032248141746	Allen-Bradley, red
Qty.	720 pc(s).	
Type	WS 10/5 MC NE GE	Version
Order No.	<a href="#">1773531687</a>	WS, Terminal marker, 10 x 5 mm, Pitch in mm (P): 5.00 Weidmueller,
GTIN (EAN)	4032248141753	Allen-Bradley, yellow
Qty.	720 pc(s).	
Type	WS 10/5 MC NE WS	Version
Order No.	<a href="#">1635000000</a>	WS, Terminal marker, 10 x 5 mm, Pitch in mm (P): 5.00 Weidmueller,
GTIN (EAN)	4008190261948	Allen-Bradley, white
Qty.	720 pc(s).	
Type	WS 10/5 PLUS MC NE WS	Version
Order No.	<a href="#">1046380000</a>	WS, Terminal marker, 10 x 5 mm, Pitch in mm (P): 5.00 Weidmueller,
GTIN (EAN)	4032248782086	Allen-Bradley, white
Qty.	600 pc(s).	
Type	WS 10/5 M PLUS MC NE WS	Version
Order No.	<a href="#">2003770000</a>	WS, Terminal marker, 10 x 5 mm, Pitch in mm (P): 5.00 Weidmueller,
GTIN (EAN)	4050118424447	Allen-Bradley, white
Qty.	600 pc(s).	
Type	WS 10/5 MC NE BL	Version
Order No.	<a href="#">1773531693</a>	WS, Terminal marker, 10 x 5 mm, Pitch in mm (P): 5.00 Weidmueller,
GTIN (EAN)	4032248141814	Allen-Bradley, blue
Qty.	720 pc(s).	
Type	WS 10/5 M MC NE WS	Version
Order No.	<a href="#">1792000000</a>	WS, Terminal marker, 10 x 5 mm, Pitch in mm (P): 5.00 Weidmueller,
GTIN (EAN)	4032248223862	Allen-Bradley, white
Qty.	720 pc(s).	

## AL2C 2.5

**Weidmüller Interface GmbH & Co. KG**  
Klingenbergstraße 26  
D-32758 Detmold  
Germany

www.weidmueller.com

## Accessories

## Blank



WS markers are the perfect match for the W-series connectors. Thanks to their system compatibility, the WS tags can also be used with the I-series and the Z-series. The large marking surfaces do not only permit long character strings but also multi-line text. WS markers are ideal for labels with long, customised character strings. Thanks to the proven MultiCard format, printing with PrintJet CONNECT oder/or Plotter is possible.

- Can be fitted in strips or individually
- Markers in proven MultiCard format

**For custom printing:** Please send us a file of our labeling software M-Print PRO or M-Print PRO Online (without installation) for your labeling specifications.

## General ordering data

Type	WS 8/5 MC NE OR	Version
Order No.	<a href="#">1773521690</a>	WS, Terminal marker, 8 x 5 mm, Pitch in mm (P): 5.00 Weidmueller,
GTIN (EAN)	4032248143092	Allen-Bradley, orange
Qty.	720 pc(s).	
Type	WS 8/5 PLUS MC NE WS	Version
Order No.	<a href="#">1951870000</a>	WS, Terminal marker, 8 x 5 mm, Pitch in mm (P): 5.00 Weidmueller,
GTIN (EAN)	4032248631605	Allen-Bradley, white
Qty.	600 pc(s).	
Type	WS 8/5 MC NE RT	Version
Order No.	<a href="#">1773521686</a>	WS, Terminal marker, 8 x 5 mm, Pitch in mm (P): 5.00 Weidmueller,
GTIN (EAN)	4032248141531	Allen-Bradley, red
Qty.	720 pc(s).	
Type	WS 8/5 MC NE BL	Version
Order No.	<a href="#">1773521693</a>	WS, Terminal marker, 8 x 5 mm, Pitch in mm (P): 5.00 Weidmueller,
GTIN (EAN)	4032248141715	Allen-Bradley, blue
Qty.	720 pc(s).	
Type	WS 8/5 MC NE GE	Version
Order No.	<a href="#">1773521687</a>	WS, Terminal marker, 8 x 5 mm, Pitch in mm (P): 5.00 Weidmueller,
GTIN (EAN)	4032248141548	Allen-Bradley, yellow
Qty.	720 pc(s).	
Type	WS 8/5 MC NE WS	Version
Order No.	<a href="#">1640740000</a>	WS, Terminal marker, 8 x 5 mm, Pitch in mm (P): 5.00 Weidmueller,
GTIN (EAN)	4008190279103	Allen-Bradley, white
Qty.	720 pc(s).	

## AL2C 2.5

**Weidmüller Interface GmbH & Co. KG**  
 Klingenbergstraße 26  
 D-32758 Detmold  
 Germany

www.weidmueller.com

## Accessories

## Custom printing



WS markers are the perfect match for the W-series connectors. Thanks to their system compatibility, the WS tags can also be used with the I-series and the Z-series. The large marking surfaces do not only permit long character strings but also multi-line text. WS markers are ideal for labels with long, customised character strings. Thanks to the proven MultiCard format, printing with PrintJet CONNECT oder/or Plotter is possible.

- Can be fitted in strips or individually
- Markers in proven MultiCard format

**For custom printing:** Please send us a file of our labeling software M-Print PRO or M-Print PRO Online (without installation) for your labeling specifications.

## General ordering data

Type	WS 8/5 MC SDR	Version
Order No.	<a href="#">1640750000</a>	WS, Terminal marker, 8 x 5 mm, Pitch in mm (P): 5.00 Weidmueller,
GTIN (EAN)	4008190456627	Allen-Bradley, To customer specification
Qty.	144 pc(s).	
Type	WS 8/5 PLUS MC SDR	Version
Order No.	<a href="#">1038790000</a>	WS, Terminal marker, 8 x 5 mm, Pitch in mm (P): 5.00 Weidmueller,
GTIN (EAN)	4032248768066	Allen-Bradley, To customer specification
Qty.	120 pc(s).	

## A-Series



Weidmüller's range of products includes end brackets that guarantee a permanent, reliable mounting on the terminal rail and prevent sliding. Versions with and without screws are available. The end brackets include marking options, also for group markers, and also a test plug holder.

## General ordering data

Type	AEB 35 SC/1 BK	Version
Order No.	<a href="#">2475310000</a>	A-series, End bracket
GTIN (EAN)	4050118487114	
Qty.	50 pc(s).	
Type	AEB 35 SCL/1 V0	Version
Order No.	<a href="#">2661280000</a>	A-series, End bracket
GTIN (EAN)	4050118702163	
Qty.	20 pc(s).	
Type	AEB 35 SC/1	Version
Order No.	<a href="#">1991920000</a>	A-series, End bracket
GTIN (EAN)	4050118376722	
Qty.	50 pc(s).	

Creation date May 23, 2023 9:01:01 PM CEST



## Data sheet

### AL2C 2.5

**Weidmüller Interface GmbH & Co. KG**  
 Klingenbergstraße 26  
 D-32758 Detmold  
 Germany

[www.weidmueller.com](http://www.weidmueller.com)

## Accessories

Type	AEB 35 SCL/1 V0 GY	Version
Order No.	<a href="#">2661290000</a>	A-series, End bracket
GTIN (EAN)	4050118702170	
Qty.	20 pc(s).	
Type	AEB 35 SCL/1 V0 BK	Version
Order No.	<a href="#">2661300000</a>	A-series, End bracket
GTIN (EAN)	4050118702187	
Qty.	20 pc(s).	

### 2.5 mm<sup>2</sup>

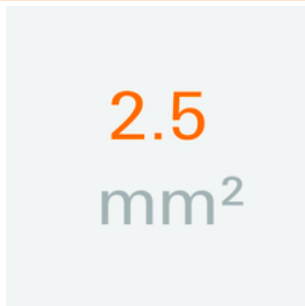

End plates are fitted to the open side of the last modular terminal before the end bracket. The use of an end plate ensures the function of the modular terminal and the specified rated voltage. It guarantees protection against contact with live parts and makes the final terminal finger-proof.

### General ordering data

Type	ALEP 2C 2.5
Order No.	<a href="#">2871750000</a>
GTIN (EAN)	4064675639879
Qty.	20 pc(s).
Type	ALEP 2C 2.5 BL
Order No.	<a href="#">2871760000</a>
GTIN (EAN)	4064675639886
Qty.	20 pc(s).

## AL2C 2.5

Weidmüller Interface GmbH &amp; Co. KG

Klingenbergstraße 26

D-32758 Detmold

Germany

www.weidmueller.com

## Accessories

## Blank



The Dekafix (DEK) marker is the universal marker for all conductor and plug-in connectors as well as for electronic sub-assemblies. The system is ideal for short number sequences and covers a wide range of ready-printed markers.

Strips for fast installation in only one work step. The printing is easy to read, rich in contrast and available in various widths.

- Large range of ready-to-use markers
- Strips for fast installation
- Terminal markers, suitable for all Weidmüller cable connectors
- Available as blank MultiCard or with standard printing

**For custom printing:** Please send us a file of our labeling software M-Print PRO or M-Print PRO Online (without installation) for your labeling specifications.

## General ordering data

Type	DEK 5/5 MC NE SW	Version
Order No.	<a href="#">1457550000</a>	Dekafix, Terminal marker, 5 x 5 mm, Pitch in mm (P): 5.00
GTIN (EAN)	4050118263817	Weidmueller, black
Qty.	1,000 pc(s).	
Type	DEK 5/5 MC NE RT	Version
Order No.	<a href="#">1609801686</a>	Dekafix, Terminal marker, 5 x 5 mm, Pitch in mm (P): 5.00
GTIN (EAN)	4008190397128	Weidmueller, red
Qty.	1,000 pc(s).	
Type	DEK 5/5 MC NE WS	Version
Order No.	<a href="#">1609801044</a>	Dekafix, Terminal marker, 5 x 5 mm, Pitch in mm (P): 5.00
GTIN (EAN)	4008190397111	Weidmueller, white
Qty.	1,000 pc(s).	
Type	DEK 5/5 S MC NE WS	Version
Order No.	<a href="#">1341620000</a>	Dekafix, Terminal marker, 5 x 5 mm, Pitch in mm (P): 5.00
GTIN (EAN)	4050118145793	Weidmueller, white
Qty.	400 pc(s).	
Type	DEK 5/5 MC NE BR	Version
Order No.	<a href="#">1249870000</a>	Dekafix, Terminal marker, 5 x 5 mm, Pitch in mm (P): 5.00
GTIN (EAN)	4050118051865	Weidmueller, brown
Qty.	1,000 pc(s).	
Type	DEK 5/5 MC NE GE	Version
Order No.	<a href="#">1609801687</a>	Dekafix, Terminal marker, 5 x 5 mm, Pitch in mm (P): 5.00
GTIN (EAN)	4008190397135	Weidmueller, yellow
Qty.	1,000 pc(s).	
Type	DEK 5/5 MC NE OR	Version
Order No.	<a href="#">1238340000</a>	Dekafix, Terminal marker, 5 x 5 mm, Pitch in mm (P): 5.00
GTIN (EAN)	4050118062632	Weidmueller, orange
Qty.	1,000 pc(s).	
Type	DEK 5/5 MC NE GR	Version
Order No.	<a href="#">1609801691</a>	Dekafix, Terminal marker, 5 x 5 mm, Pitch in mm (P): 5.00
GTIN (EAN)	4008190397159	Weidmueller, grey
Qty.	1,000 pc(s).	

Creation date May 23, 2023 9:01:01 PM CEST

## AL2C 2.5

Weidmüller Interface GmbH &amp; Co. KG

Klingenbergstraße 26

D-32758 Detmold

Germany

www.weidmueller.com

## Accessories

Type	DEK 5/5 MC NE BL	Version
Order No.	<a href="#">1609801693</a>	Dekafix, Terminal marker, 5 x 5 mm, Pitch in mm (P): 5.00
GTIN (EAN)	4008190397166	Weidmueller, blue
Qty.	1,000 pc(s).	
Type	DEK 5/5 MC NE GN	Version
Order No.	<a href="#">1609801688</a>	Dekafix, Terminal marker, 5 x 5 mm, Pitch in mm (P): 5.00
GTIN (EAN)	4008190397142	Weidmueller, green
Qty.	1,000 pc(s).	
Type	DEK 5/5 MC NE VI	Version
Order No.	<a href="#">1249860000</a>	Dekafix, Terminal marker, 5 x 5 mm, Pitch in mm (P): 5.00
GTIN (EAN)	4050118042764	Weidmueller, violet
Qty.	1,000 pc(s).	

## V0



The Dekafix (DEK) marker is the universal marker for all conductor and plug-in connectors as well as for electronic sub-assemblies. The system is ideal for short number sequences and covers a wide range of ready-printed markers.

Strips for fast installation in only one work step. The printing is easy to read, rich in contrast and available in various widths.

- Large range of ready-to-use markers
- Strips for fast installation
- Terminal markers, suitable for all Weidmüller cable connectors
- Available as blank MultiCard or with standard printing

**For custom printing:** Please send us a file of our labeling software M-Print PRO or M-Print PRO Online (without installation) for your labeling specifications.

## General ordering data

Type	DEK 5/5 MC NE V0 WS	Version
Order No.	<a href="#">1388530000</a>	Dekafix, Terminal marker, 5 x 5 mm, Pitch in mm (P): 5.00
GTIN (EAN)	4050118188622	Weidmueller, white
Qty.	1,000 pc(s).	

## AL2C 2.5

**Weidmüller Interface GmbH & Co. KG**  
 Klingenbergstraße 26  
 D-32758 Detmold  
 Germany

[www.weidmueller.com](http://www.weidmueller.com)

## Accessories

## Miscellaneous



We offer a broad portfolio of mounting support for easy handling and supplementation of our products. From various tools to insulating sleeves and various screws, our components are matched to each other down to the last detail and thus facilitate assembly in compliance with the respective standards and protective regulations.

## General ordering data

Type	BZT 1 WS 10/5	Version
Order No.	<a href="#">1805490000</a>	Accessories, Marker holder
GTIN (EAN)	4032248270231	
Qty.	100 pc(s).	
Type	BZT 1 ZA WS 10/5	Version
Order No.	<a href="#">1805520000</a>	Accessories, Marker holder
GTIN (EAN)	4032248270248	
Qty.	100 pc(s).	

## WS 8/5



## WS/ DEK

MultiMark terminal markers use an innovative composite material made from two components. The hard base contour of the marker snaps securely into the connector. The elastic surface finish makes the marker easy to mount. This specially punched material enables the strips to be stretched to accommodate the slight variations in spacing that tend to add up, especially with long terminal blocks. Another advantage: the excellent printability of the surface material guarantees durable and wear-resistant labelling. A print resolution of 300 dpi also produces a very legible script.

## Your benefits with MultiMark

- Firm hold and durable printing
- Continuous strips save installation time
- Easy mounting thanks to an innovative composite material
- Large label field for optimal legibility
- High flexibility thanks to manufacturer independence

## General ordering data

Type	WS 8/5 MM WS	Version
Order No.	<a href="#">2007150000</a>	WS, Terminal marker, 8 x 5 mm, Weidmueller, white
GTIN (EAN)	4050118392029	
Qty.	800 pc(s).	

## X-ON Electronics

Largest Supplier of Electrical and Electronic Components

*Click to view similar products for [DIN Rail Terminal Blocks](#) category:*

*Click to view products by [Weidmuller](#) manufacturer:*

Other Similar products are found below :

[00110420202](#) [00175550302](#) [8WA1011-1BH23](#) [9123140000](#) [RBO 5-T-B-HEX](#) [HSL-TB64-DIN](#) [90.070](#) [90.202](#) [912314](#) [260-301\\_NR](#) [280-560](#) [280-564](#) [281-611/281-542](#) [281-673/281-411](#) [281-994](#) [283-317](#) [283-607](#) [264-724](#) [264-726](#) [280-530](#) [280-555](#) [280-619](#) [281-610](#) [281-622/281-417](#) [284-317](#) [2907033](#) [35956](#) [USK 10](#) [102510](#) [5520682](#) [EMH 25-ZE30](#) [1SNK706410R0000](#) [1SNK705210R0000](#)  
[1SNK705151R0000](#) [1SNK506066R0000](#) [1SNK506061R0000](#) [1SNK506012R0000](#) [1SNK505060R0000](#) [UM 45-SEFE M.NUT BK](#)  
[1SNK506013R0000](#) [1SNK506030R0000](#) [1SNK508062R0000](#) [1SNK508065R0000](#) [1SNK508066R0000](#) [1SNK705010R0000](#)  
[1SNK705012R0000](#) [1SNK705150R0000](#) [1SNK705152R0000](#) [1SNK705310R0000](#) [1SNK706010R0000](#)