

## MCZ O 5VTTL

**Weidmüller Interface GmbH & Co. KG**

Klingenbergstraße 26

D-32758 Detmold

Germany

www.weidmueller.com

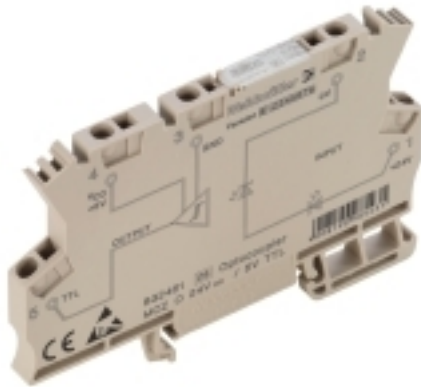

Similar to illustration

High reliability in a terminal block format

MCZ SERIES relay modules are among the smallest on the market. Thanks to the small width of just 6.1 mm, a lot of space can be saved in the panel. All products in the series have three cross-connection terminals and are distinguished by simple wiring with plug-in cross-connections. The tension clamp connection system, proven a million times over, and the integrated reverse polarity protection ensure a high level of safety during installation and operation. Precisely fitting accessories from cross-connectors to markers and end plates make the MCZ SERIES versatile and convenient to use.

- Tension clamp connection
- Integrated cross-connection in input/output.
- Clampable conductor cross-section is 0.5 to 1.5 mm<sup>2</sup>
- Variants of the MCZ TRAK type are particularly suitable for the transport sector and tested according to DIN EN 50155

### General ordering data

Version	MCZ SERIES, Solid-state relay, Rated control voltage: 5 V TTL , Rated switching voltage: 5...48 V DC, Continuous current: 100 mA, Tension-clamp connection
Order No.	<a href="#">8398940000</a>
Type	MCZ O 5VTTL
GTIN (EAN)	4008190985448
Qty.	10 pc(s).

## MCZ O 5VTTL

Weidmüller Interface GmbH &amp; Co. KG

Klingenbergstraße 26

D-32758 Detmold

Germany

www.weidmueller.com

## Technical data

## Dimensions and weights

Depth	63.2 mm	Depth (inches)	2.488 inch
Height	91 mm	Height (inches)	3.583 inch
Width	6.1 mm	Width (inches)	0.24 inch
Net weight	20.2 g		

## Temperatures

Storage temperature	-40 °C...60 °C	Operating temperature	-25 °C...40 °C
Humidity	40 °C / 93 % rel. humidity, no condensation		

## Probability of failure

MTTF	2,114 Years
------	-------------

## Environmental Product Compliance

REACH SVHC	Lead 7439-92-1
------------	----------------

## Rated data UL

Certificate No. (cURus)	E141197
-------------------------	---------

## Control side

Rated control voltage	5 V TTL	Nominal control current	1.65 mA DC
Power rating	10 mW	Status indicator	Green LED
Nominal auxiliary voltage	5 V DC $\pm$ 5 %		

## Load side

Rated switching voltage	5...48 V DC	Continuous current	0.1 A
Voltage drop at max. load	$\leq$ 1.8 V	Switch-on delay	$\leq$ 17 $\mu$ s
Switch-off delay	$\leq$ 250 $\mu$ s	max. switching frequency (DC control voltage)	2.4 kHz
Protective circuit, load side	Diode circuit	Short-circuit-proof	No
Contact type	1 NO contact (TTL)		

## General data

Rail	TS 35	
Test button available	No	
Colour	beige	
UL94 flammability rating component	Component	Housing
	UL94 flammability rating	V-0

## Insulation coordination

Rated voltage	300 V	Pollution severity	2
Surge voltage category	III	Clearance and creepage distances for control side - load side	$\geq$ 5.5 mm
Dielectric strength for control side - load side	1 kV <sub>eff</sub> / 1 s	Dielectric strength to mounting rail	4 kV <sub>eff</sub> / 1 Min.
Impulse withstand voltage	6 kV (1.2/50 $\mu$ s)	Protection degree	IP20

Creation date March 26, 2022 7:49:33 AM CET

Catalogue status 11.03.2022 / We reserve the right to make technical changes.

## MCZ O 5VTTL

Weidmüller Interface GmbH &amp; Co. KG

Klingenbergstraße 26

D-32758 Detmold

Germany

www.weidmueller.com

## Technical data

## Further details of approvals / standards

Standards	UL508	Certificate No. (CSA)	154685-1198742
Certificate No. (cURus)	E141197		

## Connection data

Wire connection method	Tension-clamp connection	Stripping length, rated connection	8 mm
Clamping range, rated connection	1.5 mm <sup>2</sup>	Clamping range, min.	0.5 mm <sup>2</sup>
Clamping range, max.	1.5 mm <sup>2</sup>	Wire connection cross section AWG, min.	AWG 26
Wire connection cross section AWG, max.	AWG 16	Wire cross-section, solid, min.	0.5 mm <sup>2</sup>
Wire cross-section, solid, max.	1.5 mm <sup>2</sup>	Wire cross-section, solid, min. (AWG)	AWG 26
Wire cross-section, solid, max. (AWG)	AWG 16	Wire connection cross section, finely stranded, min.	0.5 mm <sup>2</sup>
Wire connection cross section, finely stranded, max.	1.5 mm <sup>2</sup>	Wire cross-section, finely stranded, min. (AWG)	AWG 26
Wire cross-section, finely stranded, max. (AWG)	AWG 16	Wire connection cross-section, finely stranded with wire-end ferrules DIN 46228/4, min.	0.5 mm <sup>2</sup>
Wire connection cross-section, finely stranded with wire-end ferrules DIN 46228/4, max.	1.5 mm <sup>2</sup>	Conductor cross-section, flexible, AEH (DIN 46228-1), min.	0.5 mm <sup>2</sup>
Conductor cross-section, flexible, AEH (DIN 46228-1), max.	1.5 mm <sup>2</sup>	Blade size	0.6 x 3.5 mm

## Classifications

ETIM 6.0	EC001504	ETIM 7.0	EC001504
ETIM 8.0	EC001504	ECLASS 9.0	27-37-16-04
ECLASS 9.1	27-37-16-04	ECLASS 10.0	27-37-16-04
ECLASS 11.0	27-37-16-04		

## Important note

Product information The cable lengths must not exceed 30 m.

## Approvals

Approvals



ROHS	Conform
UL File Number Search	E141197

## Downloads

Approval/Certificate/Document of Conformity	<a href="#">EU Konformitätserklärung / EU Declaration of Conformity</a>
Engineering Data	<a href="#">CAD data – STEP</a>
Engineering Data	<a href="#">EPLAN, WSCAD</a>
User Documentation	<a href="#">Beipackzettel / Package Insert – multilingual</a>
Catalogues	<a href="#">Catalogues in PDF-format</a>
Brochures	

Creation date March 26, 2022 7:49:33 AM CET

Catalogue status 11.03.2022 / We reserve the right to make technical changes.

**Data sheet**

**MCZ O 5VTTL**

**Weidmüller Interface GmbH & Co. KG**  
 Klingenbergstraße 26  
 D-32758 Detmold  
 Germany

[www.weidmueller.com](http://www.weidmueller.com)

**Drawings**

**Wiring diagram**

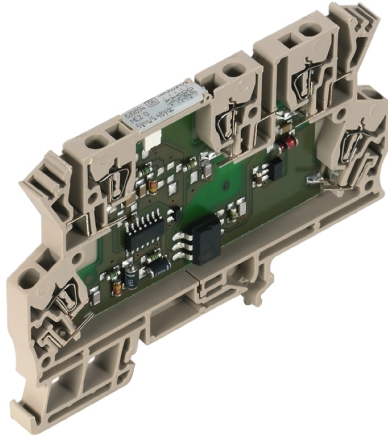

Similar to illustration

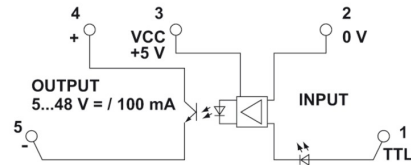

Schaltsymbol

**Dimensional drawing**

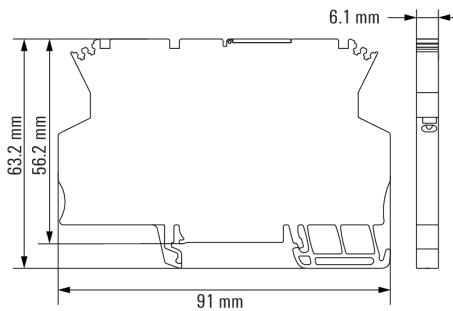

## MCZ O 5VTTL

**Weidmüller Interface GmbH & Co. KG**  
 Klingenbergstraße 26  
 D-32758 Detmold  
 Germany

[www.weidmueller.com](http://www.weidmueller.com)

## Accessories

## Slotted screwdriver

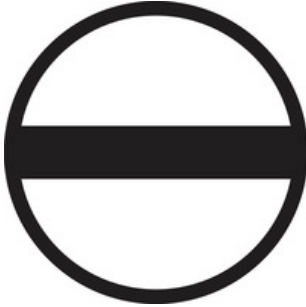

Slotted screwdriver with rounded blade SD DIN 5265, ISO 2380/2, output to DIN 5264, ISO 2380/1. ChromTop tip, SoftFinish grip

## General ordering data

Type	SDS 0.6X3.5X100	Version
Order No.	<a href="#">2749340000</a>	Screwdriver, Blade width (B): 3.5 mm, Blade length: 100 mm, Blade thickness (A): 0.6 mm
GTIN (EAN)	4050118895568	
Qty.	1 pc(s).	

## Slotted screwdriver

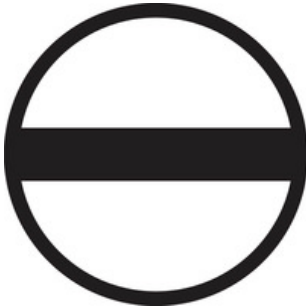

VDE insulated slot-head screwdriver, SDI DIN 7437, ISO 2380/2, drive output acc. to DIN 5264, ISO 2380/1. SoftFinish grip

## General ordering data

Type	SDIS 0.6X3.5X100	Version
Order No.	<a href="#">2749810000</a>	Screwdriver, Blade width (B): 3.5 mm, Blade length: 100 mm, Blade thickness (A): 0.6 mm
GTIN (EAN)	4050118897012	
Qty.	1 pc(s).	

**MCZ O 5VTTL**

**Weidmüller Interface GmbH & Co. KG**  
 Klingenbergstraße 26  
 D-32758 Detmold  
 Germany

www.weidmueller.com

**Accessories**

**2.5 mm<sup>2</sup>**



The plug-in cross-connections feature easy handling and quick installation. This saves a great deal of time during installation in comparison with screwed solutions.

**General ordering data**

Type	ZQV 2.5N/20 SW	Version
Order No.	<a href="#">1909130000</a>	Z-series, Cross-connector, For the terminals, Number of poles: 20
GTIN (EAN)	4032248535910	
Qty.	20 pc(s).	

**Slotted screwdriver**

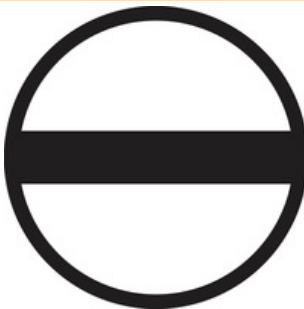

VDE insulated screwdriver sets, for working on live parts up to 1000 V AC and 1500 V DC, DIN EN 60900. IEC 900. Each piece is "GS" safety tested. Blade made from fully hardened, high-alloy chromium-vanadium-molybdenum steel, gun-metal finish.

**General ordering data**

Type	SDIS SLIM 0.6X3.5X100	Version
Order No.	<a href="#">2749610000</a>	Mounting tool, Blade width (B): 3.5 mm, Blade length: 100 mm, Blade thickness (A): 0.6 mm
GTIN (EAN)	4050118896350	
Qty.	1 pc(s).	

MCZ O 5VTTL

Weidmüller Interface GmbH & Co. KG  
 Klingenbergstraße 26  
 D-32758 Detmold  
 Germany

www.weidmueller.com

Accessories

Blank



WS markers are the perfect match for the W-series connectors. Thanks to their system compatibility, the WS tags can also be used with the I-series and the Z-series. The large marking surfaces do not only permit long character strings but also multi-line text. WS markers are ideal for labels with long, customised character strings. Thanks to the proven MultiCard format, printing with PrintJet CONNECT oder/or Plotter is possible.

- Can be fitted in strips or individually
- Markers in proven MultiCard format

**For custom printing:** Please send us a file of our labeling software M-Print PRO or M-Print PRO Online (without installation) for your labeling specifications.

General ordering data

Type	WS 10/6 MC NE WS	Version
Order No.	<a href="#">1828450000</a>	WS, Terminal marker, 10 x 6 mm, Pitch in mm (P): 6.00 Weidmueller,
GTIN (EAN)	4032248350513	Allen-Bradley, white
Qty.	600 pc(s).	

4 mm<sup>2</sup>

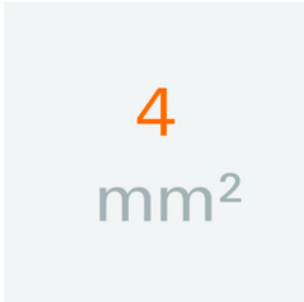

The plug-in cross-connections feature easy handling and quick installation. This saves a great deal of time during installation in comparison with screwed solutions.

General ordering data

Type	ZQV 4N/20 RT	Version
Order No.	<a href="#">1909150000</a>	Accessories, Cross-connector, 32 A
GTIN (EAN)	4032248535934	
Qty.	20 pc(s).	
Type	ZQV 4N/10 SW	Version
Order No.	<a href="#">1794060000</a>	Accessories, Cross-connector, 32 A
GTIN (EAN)	4032248234059	
Qty.	20 pc(s).	
Type	ZQV 4N/3 SW	Version
Order No.	<a href="#">1794000000</a>	Accessories, Cross-connector, 32 A
GTIN (EAN)	4032248233793	
Qty.	60 pc(s).	
Type	ZQV 4N/20 GE	Version
Order No.	<a href="#">1909020000</a>	Accessories, Cross-connector, 32 A
GTIN (EAN)	4032248535644	
Qty.	20 pc(s).	

Creation date March 26, 2022 7:49:33 AM CET

## MCZ O 5VTTL

**Weidmüller Interface GmbH & Co. KG**  
 Klingenbergstraße 26  
 D-32758 Detmold  
 Germany

[www.weidmueller.com](http://www.weidmueller.com)

## Accessories

Type	ZQV 4N/20 BL	Version
Order No.	<a href="#">1909100000</a>	Accessories, Cross-connector, 32 A
GTIN (EAN)	4032248535774	
Qty.	20 pc(s).	
Type	ZQV 4N/2 SW	Version
Order No.	<a href="#">1793970000</a>	Accessories, Cross-connector, 32 A
GTIN (EAN)	4032248233762	
Qty.	60 pc(s).	
Type	ZQV 4N/4 SW	Version
Order No.	<a href="#">1794030000</a>	Accessories, Cross-connector, 32 A
GTIN (EAN)	4032248233915	
Qty.	60 pc(s).	

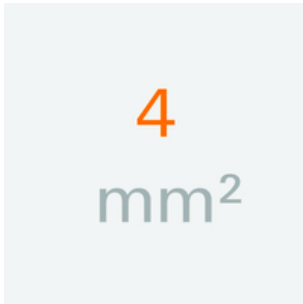
4 mm<sup>2</sup>

The plug-in cross-connections feature easy handling and quick installation. This saves a great deal of time during installation in comparison with screwed solutions.

## General ordering data

Type	ZQV 4N/4 RD
Order No.	<a href="#">2460800000</a>
GTIN (EAN)	4050118476224
Qty.	60 pc(s).
Type	ZQV 4N/3
Order No.	<a href="#">1527940000</a>
GTIN (EAN)	4050118332865
Qty.	60 pc(s).
Type	ZQV 4N/4
Order No.	<a href="#">1527970000</a>
GTIN (EAN)	4050118332889
Qty.	60 pc(s).
Type	ZQV 4N/3 BL
Order No.	<a href="#">1528080000</a>
GTIN (EAN)	4050118333008
Qty.	60 pc(s).
Type	ZQV 4N/4 BL
Order No.	<a href="#">1528120000</a>
GTIN (EAN)	4050118332872
Qty.	60 pc(s).
Type	ZQV 4N/10 RD
Order No.	<a href="#">2460740000</a>
GTIN (EAN)	4050118476163
Qty.	20 pc(s).

Creation date March 26, 2022 7:49:33 AM CET



**Data sheet**

**MCZ O 5VTTL**

**Weidmüller Interface GmbH & Co. KG**  
 Klingenbergstraße 26  
 D-32758 Detmold  
 Germany

www.weidmueller.com

**Accessories**

Type	ZQV 4N/2 BL
Order No.	<a href="#">1528040000</a>
GTIN (EAN)	4050118332773
Qty.	60 pc(s).
Type	ZQV 4N/2
Order No.	<a href="#">1527930000</a>
GTIN (EAN)	4050118332766
Qty.	60 pc(s).
Type	ZQV 4N/2 RD
Order No.	<a href="#">2460450000</a>
GTIN (EAN)	4050118476149
Qty.	60 pc(s).
Type	ZQV 4N/10 BL
Order No.	<a href="#">1528230000</a>
GTIN (EAN)	4050118333138
Qty.	20 pc(s).
Type	ZQV 4N/10
Order No.	<a href="#">1528090000</a>
GTIN (EAN)	4050118332896
Qty.	20 pc(s).
Type	ZQV 4N/3 RD
Order No.	<a href="#">2460810000</a>
GTIN (EAN)	4050118476231
Qty.	60 pc(s).

**AP MCZ 1.5 - End plate**



Open miniature housing in modular terminal format with five tension clamp connections. A transparent hinged top plate can be used for labelling and provides access to potentiometer and status displays. Plug-in cross-connectors can be used to interconnect the three top connections. A cover plate for closing off the housing is also available.

**General ordering data**

Type	AP MCZ1.5 1674	Version
Order No.	<a href="#">8389030000</a>	Small housing, OMNIMATE Housing - TERMINALBOX grey-beige, End plate, Width: 1.5 mm
GTIN (EAN)	4008190386849	
Qty.	50 pc(s).	

## X-ON Electronics

Largest Supplier of Electrical and Electronic Components

*Click to view similar products for [Solid State Relays - Industrial Mount](#) category:*

*Click to view products by [Weidmuller](#) manufacturer:*

Other Similar products are found below :

[D2440-C](#) [H10CA4890](#) [D4875C](#) [1395831-1](#) [1616010-6](#) [BR312BY](#) [A-1326](#) [H10CA4850](#) [H12CA4890VL](#) [RA2410-D06](#) [RA2410HA06T](#)  
[D1202F](#) [D53TP50-10](#) [W230E-1-12](#) [W230T-3-12](#) [1-1617030-3](#) [1-1617033-7](#) [MS2-D2420](#) [MS2-D2430](#) [A-1440](#) [RJ1P60V50E](#) [HS501DR-](#)  
[D2425](#) [RN1F48I50](#) [70.362.1028.0](#) [7-1393030-8](#) [Z5.509.0828.0](#) [G3DZ-4B DC24](#) [G3DZ-F4B DC12](#) [2912138](#) [SSRDAC10](#) [SSR-10048RD1](#)  
[RV8S-L-A240-D24](#) [RV8S-L-A240-D6](#) [RV8S-S-A240-D6](#) [RV8S-S-A240Z-D24](#) [RV8S-S-D24-A240](#) [RV8S-S-D48-A120](#) [RN1F12V50](#)  
[RJ1P60I30E](#) [RJ1P60V30E](#) [SO967860](#) [SMT8628521](#) [SO869970](#) [SOD867180](#) [SAL961360](#) [SO867970](#) [SOB863860](#) [SOB867640](#) [G3PH-](#)  
[5150B DC5-24](#) [G3PH-2075B DC5-24](#)